



CATALOG **MARINE  
EQUIPMENT**



2022|2023

## Terms and Conditions of Sales of ALLPA B.V.

### 1. Definitions

**1.1. Allpa:** The company with limited liability Allpa B.V., established Kerkenbos 10-15 (6546 BB) Nijmegen.

**1.2. Customer:** The person or company with whom Allpa agrees to establish a sales transaction.

**1.3. Products:** The products about which Allpa and the customer come to a sales agreement, as well as related advice, in writing, that has been or will be given by Allpa to the customer.

### 2. Applicability of the General Terms and Conditions

**2.1.** These Terms and Conditions apply to all offers from and agreements with Allpa.

**2.2.** Agreements and/or promises made orally and that deviate from the contents of these terms and conditions can bind Allpa solely if they are confirmed in writing by Allpa. Allpa explicitly rejects terms and conditions of the customer.

### 3. Offers and agreements

**3.1.** All quotations and offers made by Allpa are without engagement; orders made by customer are considered to be irrevocable.

**3.2.** An agreement does not come to be, before Allpa confirms the order in writing and/or Allpa makes a start with the execution of the order.

### 4. Prices

**4.1.** All prices are ex warehouse / ex factory / ex works in EURO excluding of VAT and possible other levies from the government.

**4.2.** The price customer must pay, is the price applying on the day of acceptance (ex paragraph 3.2) in conformity with catalogue and price-lists published by Allpa

**4.3.** Prices in offers from and agreements with Allpa are based on circumstances during the formulation of the offer or agreement. Allpa always has the right to adapt prices in offers and agreements, if factors on which pricing is based (for instance, market pricing of Products, raw materials, transport, cost of personnel, insurances, currency rates, taxes and other Financial aspects) are being raised between the moment of offering or the closing of the agreement and the moment of delivery. If the price raise is more than 10% Buyer has the right to step back from the agreement.

### 5. Delivery

**5.1.** All delivery-times given by Allpa are mere indications and the cannot be considered to be fatal terms. Overdue delivery never gives buyer the right for compensation for damages or annulment of the contract or to be released from duties following from this agreement or any other agreement with Allpa. Neither has buyer these rights in case of Allpa supplying products deviating from the agreed upon products regarding packaging, volume/measurements, shape, color, weight or any other feature, assuming the usefulness of the products is not negatively influenced. Products can change or be improved resulting from technical developments.

**5.2.** Delivery of the Products takes place ex-works/ ex-factory/ ex-warehouse, in conformity with the definition of the Incoterms, applying at the moment the agreement came to being. Allpa always has right to supply an order in parts.

**5.3.** Allpa reserves the right, while postponing delivery and / or not making available Products, to ask Buyer for prepayment, in part or in full the sales-price, or to Allpa's discretion demand from Buyer a bank guarantee for the sales-price in favor of Allpa.

**5.4.** All pictures, graphs etc. published by Allpa in past, present and future publications like Product Catalogue, Web-site etc. are owned by Allpa and can be used by third parties only after explicit permission in writing by Allpa. Allpa and it's Logo are registered trademarks.

### 6. Duty to Purchase and Control Shipment; objections

**6.1.** Buyer is obliged to accept the delivery of the purchased products at the moment of agreed upon delivery or at the moment Allpa chooses to deliver. The risk for damage or loss of the Products changes at that moment from Allpa to Buyer. If Allpa has to stock Product resulting from not-timely acceptance by buyer, last mentioned party will refund the cost of this to Allpa.

**6.2.** Buyer is obliged to inspect the Products delivered by Allpa. Objections relating to visible deficiencies must be filed in writing within 5 (five) days after receipt. If the shipment is accompanied by a consignment note, the results of the inspection should be written down on the consignment note.

**6.3.** Concerning invisible deficiencies a filing term of 5 (five) days also applies, meaning that his term starts at the moment buyer is aware of the deficiency, or should be aware of it. This term ends at the latest one month after delivery of the Products.

**6.4.** If Buyer fails to file a complaint in accordance with the paragraphs above, all rights of buyer become void and Allpa is supposed to have met all her duties arising from the agreement.

**6.5.** All products have a warranty-term as established by the relevant manufacturer of the Product. In order to be valid, all complaints must be, next to the contents of paragraphs above, filed using the guarantee-form available at [www.allpa.nl](http://www.allpa.nl). Allpa does not have to start handling complaints before Buyer has met all his obligations towards her.

Products deemed by Buyer to be deficient should be returned to Allpa at buyer's cost. In such a way, that Allpa is able to judge the soundness of the complaints. Shipping Products back to Allpa cannot take place before Buyer has received an instruction in writing with a Return Authorisation Number from Allpa; Allpa will not handle shipments without Authorisation and/or shipments returned incorrectly for other reasons. Products returned incorrectly, will render any claim from Buyer void.

**6.6.** Any claim from Buyer concerning guarantee, will be void in case the deficiency is wholly or partly the result or consequence of:

**a)** information from the user-manual or installation-manual has not been observed by Buyer; Maintenance prescriptions have not been followed.

**b)** deficiencies not to be caused by material or construction failures, but result from other causes like normal wear and tear, pollution on the inside or the outside, rust and damage caused by paint, transport, freezing, overheating, strain, and/or injudicious use;

**c)** repair or any other handling of the Product by a third party without prior written consent from Allpa.

**6.7** If the Products supplied do not meet demands, in Allpa's opinion, following from the agreement they will be – at Allpa's discretion – be repaired or exchanged, or the sales price will be reduced to the level of a deficient Product in relation the total sales price.

**6.8** These general Terms and conditions also apply to replacement shipments. In case Allpa chooses to replace a Product, the replaced Products become her property.

### 7. Payment

**7.1.** All invoices will be paid by Buyer prior to or at the latest on delivery of the Products. If agreement has been made that Payment can take place according to terms stated on the invoice, these terms should be observed strictly. If there are no terms on the invoice, the invoice must be settled within 10 days after invoice date. Payment must always take place without settlement of Buyer's invoices to Allpa, without discount or postponement for any reason whatsoever, and should be made by transferring the invoice amount to a bank account number of Allpa.

**7.2.** Above mentioned payment terms apply unreservedly if minor parts of a shipment are missing, assuming the use of the Products is not prevented hereby.

**7.3.** As long as Buyer has not paid all amounts due, also amounts resulting from former transactions, Allpa is not obliged to perform the agreed upon performances, whereas Allpa's rights, among others claims for refund of damage and cost, are not affected and are maintained fully.

**7.4.** In case of late- payment or non-payment of any amount due, Allpa is entitled to receive compensation for this delay: the legal business interest according to Paragraph 6:119a BW (the Dutch book of Civil Law), to be calculated from the day the invoice amount was due until the amount was transferred to a bank account of Allpa. Besides, in case of late or non-payment, Allpa is entitled to receive compensation of extrajudicial costs fixed at 15% the amount left unpaid by Buyer. Allpa remains entitled to receive the cost that really incurred.

In case of bankruptcy, liquidation or suspension of payment, the obligations of buyer will be due immediately.

**7.5.** Payments from Buyer firstly make up for cost, secondly will be booked as interest, thirdly will be booked to reduce the original amount due. Regardless the instructions from Buyer.

### 8. Vendor retains ownership of the goods pending full payment

**8.1.** The Products Allpa supplied remain Allpa's property until Buyer has met all obligations arising from the agreement.

Obligations are among others:

a. the actions done in return related to the Product/Products supplied, as well as obligations arising from the agreement itself;

b. possible claims stemming from performances from such agreements not done by Buyer.

c. All cost Allpa has incurred resulting from the shortfall of the performance by Buyer.

These cost are fixed at 10% of the amount due not paid by Buyer. Allpa reserves the right to be entirely compensated for the cost made by her;

d. All losses Allpa suffers from reselling losses, meaning the disadvantageous difference between the unpaid sales price by Buyer and the price at which Allpa usually sells the Products in question to a third party.

**8.2.** As long as the ownership has not transferred from Vendor to Buyer, Buyer is not authorized until written consent from Allpa to do so, to let or handle the Products in such a way Allpa cannot execute her right of ownership until full payment. Reselling as part of Buyer's usual business procedures is granted, as long as Allpa has not notified Buyer that she wants to execute her right of ownership retention. In cases Buyer supplies Products to his clients prior to their payment, Buyer is obliged to insist he remains owner of the Products in conformity with the text laid down in this paragraph.

**8.3.** Buyer must mark the relative Products as being owned by Allpa. And to handle these Products with care.

**8.4.** Buyer now authorizes Allpa irrevocably, for executing her right of ownership to enter the rooms of Buyer or used by Buyer to reclaim the supplied Products. Buyer is obliged to give full cooperation to this reclaim. If Buyer refuses to do so, the penalty is set to 15% of the unpaid amount per day.

### 9. Responsibility and Safeguarding

**9.1.** Every responsibility of Allpa is limited to the amount paid by the Insurance company to cover for Allpa's responsibility, plus the amount of the own risk of Allpa. If, for any reason whatsoever no payment from the Insurance-company follows, Allpa's responsibility is limited to the total invoice-amount related to Products supplied to the relative Buyer, 12 months prior to the moment the responsibility arose. With a maximum amount of EUR 100.000,- (one-hundred-thousand EURO). Allpa can never be held responsible for loss of turnover or income or decreased goodwill, or any other indirect damage.

**9.2.** The limitations of responsibility described in the former paragraph do not apply in case Allpa is reckless or has been negligent.

**9.3.** Buyer safeguards Allpa, her Staff and Other Persons hired to execute the agreement against claims from third parties related to or stemming from reselling and resupplying of Products. Buyer is obliged to insure himself and keep himself insured against possible claims.

**9.4.** Every claim from Buyer against Allpa, except one acknowledged by Allpa, expires by the course of time after 12 months after the claim arose.

### 10. Competent Judge / Appropriate Law

**10.1.** Exclusively suitable to all offers from and agreements with Allpa is the Dutch Law. The Vienna Sales Convention is excluded.

**10.2.** The Court in Arnhem, the Netherlands, is exclusively competent and authorized to be informed of all disputes and disagreements following from or related to agreements with Allpa.

### 11. Final Definitions

**11.1.** If one or more regulations or definitions of these terms and conditions appears to be not or not entirely legally valid, the rest of the regulations and terms will remain valid.

Instead of the possible not valid regulation, a regulation will be placed that would have been in these terms if the original regulation had been abandoned on ground of being not valid.

**11.2.** The Dutch text of these Terms and Conditions prevails over translations (This is a translation).

## allpa is a leading European wholesaler with 5.000m<sup>2</sup> Warehouse.

Founded in 1971, the company is engaged in sales and marketing of parts and accessories. Soon, the understanding came that there is more to an „European Player“ than sales only: Service and competent advice are the base of the expertise in Nijmegen. Highly qualified and motivated employees are together a decisive team which is dedicated to „customer relationship“.

**allpa** is a strong and dynamic international wholesaler with products for all kinds of water sports, for sailing- and motor yacht shipyards, nautical shops, service companies, inboard- and outboard motor dealers and also for commercial shipyards. The international approach is also illustrated by our comprehensive, annual catalog of about 600 pages, available in three languages.

### Points of Competence:

- A very extensive product range
- Products with good price-quality ratio
- A very large stock
- Good logistics: short delivery lead times
- Professional advice
- Very regularly, innovative, state of the art products, are added to our range

### allpa supplies among other things:

- Marine diesel engines and generators, complete installation kits
- Marine reversing gears, controls and steering systems, propellers, propeller shaft systems
- Outboard engines and accessories, inflatable and polyester boats, boat chairs and trim tabs
- Windlasses, bow thrusters and gangways
- Sanitary systems, bilge-, drinking water-, cooling water-, black water- and fuel pumps
- Refrigerators, boilers, battery chargers and inverters
- Rescue materials, compasses and radar reflectors
- Winches and deck fittings, hatches and ports, stay tensioners



Kerkenbos 1015, 6546 BB Nijmegen  
 T: +31 (0)24 - 377 77 73  
 E: [info@allpa.eu](mailto:info@allpa.eu)  
[www.allpa-marine.com](http://www.allpa-marine.com)



## TABLE OF CONTENTS

**A**

allpa® = a-Flex CV-Shafts	559, 562
allpa® = Airconditioning Systems	416-419
allpa® = Antal Winches & Deck Equipment	622-657
allpa® = Automatic Life Jackets 150N & 275N	253-255
allpa® = Batteries	388-389
allpa® = Centa Flexible Couplings	556-559
allpa® = Compasses	260-270
allpa® = Echomax Radar Reflectors	248
allpa® = Flange Adapters	555
allpa® = Generating Sets	408-415
allpa® = Goïot Hatches	616-620
allpa® = Hyundai Seasall Scheepsmotoren	531-533
allpa® = Johnson Pump Pumps	476-477, 482-483, 485-491, 494-498
allpa® = Johnson Pump Toilets	446-451
allpa® = Lofrans Windlasses	218-226
allpa® = Polar Star Damper Plates	548-549
allpa® = Radice Rudders and Propellers	065, 580-585, 587
allpa® = Refrigerators	420-428
allpa® = Regatta Life Jackets & Floatation Suits	250-259
allpa® = Ritchie Compasses	262-270
allpa® = Rudder Arms and Glands	064
allpa® = SeaStar Jack Plates	125-127
allpa® = SeaStar Steerings & Controls	022-081
allpa® = SeaStar Trim Tab Systems	094-100
allpa® = Selva Outboards	178-184
allpa® = Shore Power Fittings & Cables	405-407
allpa® = Solé Marine Diesel Engines	506-524
allpa® = Springfield Boat Chairs	148-161
allpa® = Technodrive Marine Reversing Gears	535-547
allpa® = X-Force Bow Thrusters	090-093
12V Socket	344-345, 347
3-Way Fuel Valve, Brass	110
3-Way Valves	454-455, 459
Accumulator Tanks	479
Active-X / XS-Band Radar Target Enhancer	248
Adjustable Belt with Buckle	187, 284
Adjustable Belt with Stainless Steel Buckle	284
A-Flex CV-Shafts	560-563
Air Conditioning	416-419
Air Heating Systems	416-419, 613
Air Vent Kits for Cooling & Exhaust	606-607
Air Vents for Toilets	454-456

Air-Conditioning Systems	416-419
Alignment Valve for Hydraulic Steering	061
All Round Lights	377-379, 381-384
Allcord Ropes	241-244
All-In-One Electrical Cabinet	394
allpa Hydraulic Steering Systems	036-059
Aluminum Anodes	128-137
Aluminum Propellers	585
Aluminum Stern Tube	572
Ampere Meter	322-324, 326-327
Anchor Ball, Cone, black	204, 237, 249
Anchor Bow Rollers	235-236
Anchor Buoy's	214
Anchor Chain	234
Anchor Chain Links	234
Anchor Chain Stainless Steel	234
Anchor Lights	377-379, 381-384
Anchor Ropes	234, 239, 245-246
Anchore Ropes Leaded	234, 239
Anchors	232-233
Anchors and Accessories	232-237
Annular Fenders	215
Anodes	128-137
Anodes for Outboards & S-Drives	128-135
Anodes for Propeller Shafts	131, 136-137, 568, 588
Anodes Navalloy	128-131
Antal Winches & Deck Equipment	622-657
Antares 150N & 275N	254
Antenna Bases	350
Antenna for Radio	351
Anti-Foam Fuel Overflow	109
Anti-Foam-Overflow	109, 596
Anti-Vibration Kit throttle & shift cables	081
Automatic Life Jackets	253-255
Autopilot Pump	044
Awning Blinds	615, 619
Axial Propeller Shaft Seals	574-575

**B**

Baby Life Jacket	251
Back Stay Tensioners	621
Bailer	197
Ball Valves	459, 463, 470, 604

# TABLE OF CONTENTS



Ball Valves Plastic	201, 463	Boat Chairs	148-161
Ball Valves PVC	201, 463	Boat Cleaning Products	190-191
Ballast Pump	487	Boat Cover Support Poles	173
Balljoints for SeaStar Cylinder	062	Boat Cover Support System	173
Barbecue Electric	436	Boat Covers	173
Barrel Bolts	285	Boat Hook Bilge Pump	189
Bathing Ladder Wood	311	Boat Hooks	189
Bathing Ladders	215, 310-316	Boat Horns	245-247
Bathing Ladders Telescopic	314-315	Boat Propellers, Bronze & Aluminum	579-587
Bathing Platform Lighting	363, 374-375	Boat Trailer Accessories	186-187
Bathing Platforms	316	Boats	174-177
Batteries	388-389	Boatswain's Chairs	196
Battery Boxes	121	Boilers	472-475
Battery Cables & Eyelets	389	Bollards	274-277
Battery Cables, Terminals & Eyelets	389	Bosun's Chairs	196
Battery Chargers	392-394, 396-399	Bottle Holder	273
Battery Guard	403-404	Bow Fenders	214
Battery Guard and Fuse	322-324, 326-327, 390-391, 403-404	Bow Ladders	313
Battery Main Switches	336-337, 395, 403	Bow Protector Stainless Steel	236
Battery Monitoring Instruments	390-391	Bow Rollers	186-187, 235-236
Battery Selection Switches (also double pole)	336-337, 395, 403	Bow Thrusters	090-093
Battery Separators	395, 402-403	Bowls Washing	435, 438-439
Battery Switches	336-337, 395, 403	Bravo Electric Inflator Pump	168-169
Battery Terminals	389	Breather Nipples	112, 454-456, 461, 606
Battery Watch	390-391, 403-404	Breton Course Plotter	271
BayStar Outboard Steering Systems	036-037	Bronze Propellers	579-584, 586-587
Bearing Grease	107	Bucket	191, 197, 486
Bellows	135	Bucket Seats	150-151
Bilge Pump Filter	460, 484	Built-In Boxes	292-295
Bilge Pumps	482-485, 489, 492-493	Built-In Fuel Tanks	109-110, 597
Bilgewater Alarm	483	Buzzer with LED-Indicator	340
Bimini Tops	163-167		
Bimini Tops Accessories	162-167	<b>C</b>	
Black Signal Cone	249	Cabin Lamps	352, 356-362, 364-372
Black Water Pumps	455-456, 485, 488-489, 492-493	Cabin Lights	352, 356-362, 364-372
Bleed Nipple Caps all SeaStar Cylinders	062	Cable & Wire Protecting System for Outboards	117
Blocks	634-644, 646-647, 658-660, 664	Cable Leads (electric)	338
Blocks OPF	640-643	Cable leads (steering cable)	118
Blocks Snatch	647	Cable Steering Systems	022-034
Blocks Special	646-647	Cable Steering Systems mechanical	022-034
Blocks Stainless Steel	636-637, 644, 646, 664	Camcleats	634, 636, 640, 642, 644, 658-660, 662-663
Blowers	307-308, 609-610	Capstans	218, 222
Boat Boilers	472-475	Carbon Odor Filters	455-456, 597

## TABLE OF CONTENTS



CEE Power Plugs	406-407	Cowl Ventilators	308-309, 610-611
Ceiling Lamps	352, 356-362, 373	Cowl Ventilators Stainless Steel	308-309, 610-611
Centa Flexible Couplings	556-559	Cup Holders	273
Chain	234	Curry Clamps	634, 636, 640, 642, 644, 658-660, 662-663
Chairs	148-161	Cushions	148
Chargers Battery	392-394, 396-399	CV-Drive Shaft Systems	560-563
Chart Reading Lamps	352, 364, 373		
Chart Reading Materials	271	<b>D</b>	
Cigarette Lighters	345	Damper Plates	548-549, 551-553
Circuit Panels with LED	325, 346-349	Damper Plates Polar Star	548-549
Circulation Pumps	491	Dashkit for Hydraulic SeaStar Helms	060
Cleaning Products	190-191	Davits	317
Cleats	274-277	Deck Blocks	635, 637, 641, 643-644, 659-660, 664
Clips Plastic	203	Deck Chairs	148-161
Common Rail Diesel Engines	531-533	Deck Entries Color Coded	469, 598
Compac-T Steering System	023	Deck Entries Nylon	469, 598
Compasses	260-270	Deck Entries Stainless Steel	469-598
Compression Fasteners	285	Deck Eyes Plastic	203
Cone Insert for Steering Wheels	069	Deck Eyes Screwed Stainless Steel	641, 643
Connection Bars for Electric Wiring	338	Deck Fillers	111, 469, 598
Connection Kits Control Cables	070	Deck Fittings & Tracks	622-665
Connection Kits Hydraulic Steering	061, 063	Deck Flood Light Lamp	381, 385-386
Connection Kits Mechanical Steering	033-034	Deck Flood Lights (LED)	381, 385-386
Containers, watertight	196-197	Deck Ventilators	308-309, 610-611
Control Boxes	075-080, 082-089	Deck Wash Kit for Pump F4B-19	487
Control Cables	072-073	Deck Wash Kit with Boat Hook	188
Controls	075-080, 082-089	Deck Wash Pumps	476, 480, 492-493
Controls Electronic	082-089	Deck Winches	622-627
Controls Mechanical	075-080	Dempflex	612
Conversion Kits Marine Toilets	454	Depth Sounders	322, 326-328
Converters DC/DC	402	Deviders	271
Cookers Electric	436	Diaphragm Pumps	485, 489, 492-493
Cookers Induction	436	Diesel (Fuel) Pumps	479, 492-493
Cooling compressors	428	Diesel Engines	506-524, 531-533
Cooling Drawers Stainless Steel	424-425	Diesel Generating Sets	408-415
Cooling Units	428	Diesel Tanks	108-110, 597
Cooling Water Pumps	487, 491, 494-497	Dimmer	362, 367, 373
Cooling Water Strainers	605	Dinghies	174-177
Corrosion Stopper	404	Diode Battery Isolators	403
Cotter Rings Stainless Steel	211	Discharge Opening for Fire Extinguisher	272
Course Plotter	271	Dock Fenders	216
Courtesy Lights	368-370, 372	Dock Lights	363, 374-375
Covers for Bronze Impeller Pumps	502-503	Dock ring portable	237

# TABLE OF CONTENTS



Dog Vests	256	Energy Meter	390
Door Fasteners	202, 290-291	Engine Brackets for replacement Volvo/Yanmar	525
Door Handle	291	Engine Control Cables	072-073
Douche Accessories	444-445	Engine Controls Electronic	082-089
Drain Plugs	170, 172, 200-201	Engine Controls Mechanical	075-080
Drain Plugs and Sockets	170, 172, 200-201	Engine Installation Kits	527
Drains for Sincs	440	Engine Instruments	322-324, 326-328
Drink Holders	273	Engine Mounts	566-567
Drinking Water Filters	476, 481	Engine Oil	107, 528
Drinking Water Gear Pumps	480-481	Engine Room Ventilation	307-309, 609-611
Drinking Water Plastic Tube System Seatech	466-467	Engines, Inboard Diesel	506-524, 531-533
Drinking Water Pressure Systems	478-481	EPS Electronic Steering	046-050
Drinking Water Pumps	476-481, 492-493	Evaporators for cooling	428
Drinking Water Tank Senders	322-324, 326-327	Exhaust Dampers	601-603
Drinking Water Tanks Plastic	470	Exhaust Hose	464, 596
Drinking Water Taps	441-443	Exhaust Skin Fittings	600
Drinking Water Tubing System Seatech	466-467	Expanding Drain Plugs	170, 200-201
Drop Fenders	212	Expansion Tanks	479
D-Shackles Stainless Steel	208	Extraction Ventilators	307-308
DS-Units (Dual Station)	074	Extreme Steering „Xtreme“	031
Dyna Blocks	647	Extreme Steering „Xtreme“ (No Feedback)	031
		Eye Bolts Stainless Steel	210
		Eye Plates	210
<b>E</b>		<b>F</b>	
Echomax Radar Reflectors	248	Faeces Pumps	455-456, 485, 488-489, 492-493
Elastic Net and Object Holders	199	Faeces Tanks	455-457
Electric Fuel Line Valves	114, 596	Fairleads	203 275-276, 648, 660, 662
Electric Inflator Pump	168-169	Fairleads Plastic	203, 275, 660, 662
Electric Instruments	322-329	Fender Baskets	217
Electric Shift Kits for Technodrive Gearboxes	554	Fender Profiles	299-305
Electric Solenoid Valve for Fuel	114, 596	Fender Railing Brackets	217
Electric Solenoid Valve for Water (Toilet)	454	Fender Rope	238
Electric Toilets	448-451	Fender Snap Hooks	216
Electric Trailer Winches	187	Fenders	212-216
Electric Water Line Solenoid Valve	454, 467	Filler Kit & Flange Drinking Water Tanks	470-471
Electric Winches	626-627	Filler Kit & Flange Fuel Tanks	110, 597
Electrical Applications	325, 336-349	Filler Plugs SeaStar Helms	062
Electronic Engine Controls	082-089	Filter (water)	460, 476, 481, 484, 597, 605
Electronic Radar Reflector	248	Filters Cooling Water	605
Electronic Steering EPS	046-050	Filters Drinking Water	476, 481
Emergency Chain Connector	234	Fire Blanket	272
Emergency Ladder	312	Fire Extinguisher Built-In Box	272
Emergency Navigation Lights	381-382		
Emergency Plugs	258		

## TABLE OF CONTENTS



Fire Extinguishers	272	Gas/Water Separator	602
First Aid Boxes	272	Gasoline Tanks	108-110, 597
Fishing Rod Holders	205	Gauges Electric	322-324, 326-328
Fitting Material	458-463, 604	Gauges NMEA 2000 Universal	322-324
Fittings SeaStar Hydraulics	061, 063	Gauges SeaStar - Veethree	322-324, 326-328
Flag Poles and Pole Bases	192-193	Gear pumps for drinking water	481
Flags	194-195	Gearbox Adapters	551-553
Flexible Black Water Tanks	457	Gearbox Flange Adapters	555
Flexible Engine Mounts	566-567	Gearbox Mounting Flanges	551-553
Flexible Propeller Shaft Couplings	556-565	Gearboxes	535-547
Flexible Water Tanks	457, 470	Generator Sets	408-415
Flex-O-Fold Folding Propellers	586	Genua Sliders	652-654, 662
Float Switches	483-484	Genua Systems	652-654, 662
Floatation Jackets and Suits	250-259	Genua Tracks	651-662
Flood Lights	386-387	Glass Fibre Stern Tube Propeller Shaft System	570
Fly Screens	615, 619	Goïot Hatches	616-620
Fog Horns	245-247	Goosenecks Plastic	603
Folding Boat Chairs	148-150, 154	GPS-Speedo's	322-324
Folding Cleats	276-277	Grab Rail Fittings	282-284
Folding Grapnels	233	Grab Rails	279
Folding Mast Steps	312	Grated Water Intakes	458, 604
Folding Propellers	586-587	Grey Water Collection Tank	457, 488
Foot Switches	228, 230	Grey Water Manifold (bilge)	487
Fortress Anchors	232	Grey-Water Manifold	487, 488
Fuel Filters	112-114, 590-595	Grey-Water Tank	457, 488
Fuel Filters with Water Separator	113-114, 590-591, 595	Grill Electric	436
Fuel Gauges	322-324, 326-327	Grommets Plastic	203
Fuel Hoses	116, 456, 596	Ground Strap SeaStar Outboard Cylinders	062
Fuel Line Connectors	115	Guardian Anchors	232
Fuel Senders	112, 328-329, 468, 596		
Fuel Tanks	108-110, 597	<b>H</b>	
Fuel Tanks Plastic	108-109, 597	Half Couplings	565
Fuel Tanks Stainless Steel	116, 597	Halogen Cabin Lights	352
Funnel	120	Halyard Organizer Blocks	631-633, 645, 664
Fuse Holders	339	Halyard Slider	650
		Halyard Stoppers (Jammers)	631-634
<b>G</b>		Halyards	242-244
Gangway/Stair	318	Handles for Winches	628-629
Gangways	319	Hatch Opening Stays	280-281, 619
Gas Hob Units	432-435, 437	Hatches - Goïot	619-620
Gas Springs	280-281	Hatches Plastic	292-295
Gas Stabilizer	440	Heat Exchangers	614
Gas Stoves and Ovens	429-437	Heating (Airco) Systems	416-419



# TABLE OF CONTENTS



Heating Systems	416-419, 613	Inboard Steering Systems	049-050, 052-059
Heavy Duty Mooring Spring	240	Indicators, Wind Socks	204
Hella APELO underwater lights	374	Induction Cooker	436
Hella LED Light Bars	385	Inflatable Boat Accessories	168-169
Hella Marine Lights	372-374, 383-385	Inflatable Boat Launching Wheels	171
Helm Pumps	054	Inflatable Boat Pumps	168-169
High Load Blocks	646	Inflatable Boat Roller (beach)	
Hinges	285-289	Inflatable Boat Steering	030
Hinges, covered	288	Inflatable Boat Valve	172
Hooks, Nylon	203	Inflatable Boats	174-177
Horns	245-247	Inflatable Radar Reflector	248
Horseshoe Life Buoy	257	Inflator Pumps	168-169
Hose Clamps	599, 604	Inner Shaft Bearings	573-576
Hose Connectors universal	607	Inspection Hatches	292-295
Hose Pilars	458, 463, 604	Instrument Panel Solé	526
Hoses	453, 464-465, 607-608	Intermediate Shaft Bearing Bushings	576
Hot water Boilers	472-475	Inverters	400-401
Hot Water Hose	465	Isolated Terminals	339
Hour Counters	322-324, 326-327		
Hull Lights	363, 374-375	<b>J</b>	
Hydraulic Hoses	060	Jack Plates SeaStar	125-127
Hydraulic Oil SeaStar	062	Jammers	631-634
Hydraulic Steering Cylinders	036-059	Jet Boat Steering	032
Hydraulic Steering Systems	036-059	Jetty Fenders	216
Hydrofoils	106	Jetty Mooring Eye portable	237
Hydrophores	478-479	Johnson - Pump Jabsco Ref. List	504-504
Hyundai Seasall Marine Diesel Engines	531-533	Johnson Impellers	494, 498-501
		Johnson Pump Marine Toilets	446-451
		Johnson Pump OEM Ref. List	496-497
		Johnson Pumps	476-477, 482-483, 485-491, 494-498
		Joysticks X-Force Bow Thrusters	090-093
		<b>K</b>	
		Keel Rollers	186-187
		Key Bolts	211
		Knob Latch	291
		<b>L</b>	
		Ladders	215, 310-316
		Latches for cupboard	291
		Launching Wheels	171
		Leaded Anchor Rope	234, 239
		LED Cabin Lights	356-362, 364-367, 370-373
<b>I</b>			
Ice Cube Makers	424, 426		
Ignition Switches	345		
Impeller Bar	494		
Impeller Pedestal Pumps	494-495		
Impeller Pumps	486-487, 494-497		
Impeller Pumps Electric	486-487		
Impeller-Flange Mounted Cooling Water Pumps	496-497		
Impeller-OEM-Pumps	495-497		
Impellers	138-146, 494, 498-501		
Impellers (Inboard-Johnson)	494, 498-501		
Inboard Controls	075-080, 082-089		
Inboard Engine Installation Kits	527		
Inboard Propellers	579-584, 586-587		
Inboard Steering Cylinders	055		

## TABLE OF CONTENTS



LED Chart Reading Lights	364, 373	Matrix Gauges Mercury SmartCraft	322
LED Courtesy Lights	368-370, 372	Mechanical Seals for Propeller Shafts	574-575
LED Dimmer	362, 367, 373	Mechanical Steering Systems	022-034
LED Lights for Engine Compartment	371	Mini Switch Panels Single Function	347
LED Navigation Lights	376-380, 382-384	Mixer Taps	441-443
LED Replacement Bulbs	355	Mixer Water Tap with Built-in Shower Box	444
LED Search Light	386-387	Mobile Coolers	427
LED Underwater Lights	363, 374-375	Mooring Hook	188
LED Wall Lights	365-367	Mooring Pins	237
Life Jackets	250-259	Mooring Ropes	238-239, 241-242
Life Lines	259	Mooring Springs	240
Lifebuoy Holders	258	Motion Activated Lamps	371
Lifebuoy's	257	Motion Activated Switch	371
Lift Ring	202, 290-291	Motor Flusher	120
Lights	352-387	Motor Oil Filters Solé	528-529
Liquid Tie Bar	061	Motor Sound Deadening Plates	612
Lock for Outboard Motors	124	Mounting Flange for Stern Tube	577
Lofrans Windlasses	218-226	Mounting Tray's Plastic	119
Loud Hailer Marine Speakers	245	Multi Port Shower Sump	488
Loudspeakers for Radio	351	Multifenders for Mooring Poles	216
Louvres and Grills	309, 611		
Low Friction Rings & Loops	648-649	<b>N</b>	
Lower Unit Gear Lube	107	Nautical Bucket	191, 197, 486
<b>M</b>		Navigation Lights	376-384
Macerator Pumps	455-456, 488	Navigation Materials	271
Magnesium Anodes	128-137	Nemo Stay Tensioners	621
Magnetic Door Catches	290-291	Neoprene Shaft Bearings	578
Main Sheet Tackles	638-639	Net for Bow Rail	240
Main Travellers	655-657, 661	NFB 4.2 Rotary Steering System (No Feedback)	027
Mainsail Centipede	206	NMEA Cabels and Connectors	343
Manual Bilge Pumps	197, 485-486	<b>O</b>	
Manual Oil Extraction Pump	107, 612	Oars	188-189
Manual Search Lights	386-387	Odor Filters	455-456, 597
Manual Toilets	447	Oil and Grease	107
Marine Diesel Generating Sets	408-415	Oil Change Pumps electric	486
Marine Engines	506-524, 531-533	Oil Coolers	551-553
Marine Reversing Gears	535-547	Oil Extraction Pumps	107, 486, 612
Marine Toilets	446-451	Oil Filter Solé Diesel	528-529
Marker Buoy's	214, 237	Oil Pressure Gauges	322-324, 326-328
Marker Floats	214	Organizers	631-633, 645, 664
Marline Spike	240	Outboard Covers	120
Mast Steps	312	Outboard Engines	178-184

# TABLE OF CONTENTS



Outboard Motor Accessories	106, 108-109, 112-127	Pump Hose	202
Outboard Motor Brackets	123, 125, 127	Pumps	476-498
Outboard Motor Controls	075-080, 082-089	Purging System SeaStar Hydraulic Steering	040, 042, 061
Outboard Motor Flusher	120	Push Button Switches wit LED Indicator	340
Outboard Motor Fuel Tanks	108-109	Push/Pull Control Cables	072-073
Outboard Motor Lock	124	Push/Pull Switches	342
Outboard Motor Powerlifts	125-127		
Outer Bearing for Propeller Shafts	577	<b>R</b>	
Ovens	429-431	Rack & Pinion Steering System	028
		Rack & Pinion Steering System (No Feedback)	029
<b>P</b>		Racor Filtration	590-593
Paddles	189	Radar Reflector Tubular	204
Padlocks	124	Radar Reflectors	248-249
Pedestals for Boat Chairs	152, 157, 160-161	Radice Rudders and Propellers	065, 580-585, 587
Pinwing Kits for Impeller Pumps	495	Radio	351
Pitot	329	Radio Antenna	351
Plough Anchors	233	Radio Control Search Light	387
Pop-Out Cleats	277	Radio Cover	350
Portable LED Navigation Lights	382	Railing Fittings	284-284
Portlights	615, 618	Ratchet Blocks	660
Power Assist Systems	044-045	Reading Lamps	352, 364-367, 373
Power Plugs	405-407	Re-arming Kits for Automatic Life Jackets	256
Power Purge Junior	040, 042, 061	Reefing Hooks	203
Power Steering Systems	044-045	Refrigerators	420-428
Powerlifts for Outboards	125-127	Refrigerators Stainless Steel	422-426
Powertrim Switch	126	Remote Controls	075-080, 082-089
Pressure Gauge for Inflatable Boats	168	Replacement Bulbs	354-355
Pressure Switch	486	Rescue Light for Lifebuoy	258
Primer Bulb (with fuel line)	116	Rescue Materials	250-259, 272
Propeller Shaft Bearing Bushings	578	Revolving Bent Anchor Joint Stainless Steel	236
Propeller Shaft Bearings	573-577	Ritchie Compasses	262-270
Propeller Shaft Intermediate Bearings	576	Rope Cleats	634, 636, 640, 642, 644, 658-660, 662-663
Propeller Shaft Rope Cutters	589	Rope Cutters for Propeller Shaft	589
Propeller Shaft Struts	577	Rope Cutters for Saildrive	589
Propeller Shaft Systems	570-572	Rope Ladder	312, 315
Propeller Shafts	568	Ropes	241-244
Propellers	579-587	Rowlock Sockets	202
Propellers, Bronze and Aluminum	579-587	Rowlocks	172, 202
Protection Pads	119	Rubber Couplings	565
Protrim Switches	126	Rubber Impellers	138-146, 494, 498-501
PSS Mechanical Seals	574	Rubber Propeller Shaft Bearings	578
P-Trap Tank Vent Adapter	112	Rubber Propeller Shaft Seals	573
Pump (Syphon) Hose	202	Rudder and Stern Fitting for Dinghies	665

## TABLE OF CONTENTS



Rudder Arms	064	Shift Control Cables	072-073
Rudder Glands, brass	064	Shock Cord	244
Rudder kits for Dinghies	665	Shore Power Connectors	405-407
Rudder Position Indicators	328	Shower Built-in Box with Mixer Tap	444
Rudders Bronze	065	Showers	444-445
Rug	199	Shut-Off Control Cables	074
<b>S</b>		Sierra	107, 114-115, 337, 341, 345
Safe-T II (No Feedback) Steering System	026	Sierra Battery Switches	337
Safe-T Quick Connect Steering System	025	Sierra HALO Switches	341
Safe-T Quick Connect Steering System - Tilt	024	Sierra Oil	107
Safe-T Quick Connect Tilt Steering	024	Signal Flags	194
Safety (Kill) Switches	117	Signal Horns	245-247
Safety Bag	251	Single Handle - Dual Action - Motor Controls	075-080, 082-089
Safety Harness	259	Sinks	435, 438-439
Sail Ties	206	Ski Mirror	188
Saildrive (Volvo) Adapter Kits Solé	524	Skin Fitting Plastic	461-463
Saildrive propellers	585-587	Skin Fitting Plastic with Check Valve	201
Saildrive Rope Cutters	589	Skin Fitting Stainless Steel	600
Saildrive Unit Technodrive	547	Skin Fittings	458, 461-463
Schelde Anchors	232	Slam Latches	289-290
Sea Prop 60 Technodrive Saildrive Unit	547	Sleeves for Drain Plugs	200-201
Search Lights	386-387	Smart Tabs	104-105
SeaStar EPS	046-050	Smartsticks	044-061
SeaStar Outboard Steering Systems	023-051	Snap Davits for inflatable Boat	170
SeaStar Steering & Controls	022-081	Snap Hooks	203
SeaStar Trim Tabs	094-99	Snap Hooks Stainless Steel	209
Security Line	259	Snap Shackles	209
Security Materials	245-259, 272	Solar Power Ventilator	308-610
Security Rope	258-259	Solé Diesel Marine Engines	506-524
Seftailing Winches	623-627	Solé Engine Re-Powering Brackets	525
Selector Units	074	Solé Service Items	528-529
Self-Centering Keel Roller	186	Solenoid Control Boxes	231
Selva 4-Stroke Outboard Engines	178-184	Sound Deadening Material	612
Selva Service Parts	185	Sound Isolation Material	612
Selva Twin Outboard Sets	184	SPA SeaStar Power Assist	044-045
Service Parts Solé Diesel	528-529	Space Saver Marine Toilet	448-449
Servo Steering SeaStar Power Assist	044-045	Spare Parts Solé Diesel	528-529
Shackles Stainless Steel	208	Speakers	351
Shaft Systems (propeller)	570-572	Speedo's	322-324, 326-328
Shafts (propeller)	568	Speedy Lock Winch Handle	629
Sheaves Nylon	207	Sponges	190
Sheets	242-244	Spray Hood Fittings	282-284
		Springfield Boat Chairs	148-161

# TABLE OF CONTENTS



Stabilizer Tabs	106	Telescopic Boat Hooks	189
Stainless Steel Blocks	636-637, 644, 646, 664	Tensioning Strips Stainless Steel	211
Stainless Steel Built-in Fuel Tanks	116, 597	Thimbles Nylon & Stainless Steel	207
Stanchions and Stanchion Bases	211	Thrust Bearings	559, 562
Stand for Outboard Motor	122	Thrusters	090-093
Starting Rope	116	Tiller Extension for Dinghie Rudders	665
Static Folding Dock Stairs	320	Tiller Extensions	120
Stay Tensioners	621	Tin Holders	273
Steering Boat Chairs	148-161	Toggle Switches	340-341
Steering cable grommets	118	Toggle Switches wit LED Indicator	340-341
Steering Cables	023-032	Toilet Hoses	453, 465
Steering Console	030, 175	Toilet Installation Parts	453-457
Steering Cylinders for Inboards	049-050, 052-059	Toilet Space Saver	448-449
Steering Cylinders for Outboards	036-051	Toilet Spare Parts	452-453
Steering Cylinders for Stern Drives	049-050, 058-059	Toilets	446-451
Steering Handles	068-069	Toilets for Below Waterline Mounting	446-451
Steering Helm Hydraulic	054	Tournament Steering Cylinder	042-043
Steering Systems hydraulic	036-059	Trailer Rollers	186-187
Steering Wheels	066-069	Trailer Winch Webbing	187
Stern Bearings for Propeller Shafts	577	Trailer Winches	187
Stern Navigation Lights	376, 378, 380, 384	Transom Protection Pads	119
Stern Tubes	572	Trapeze Gear	663
Stern Tubes Brass	572	Traveller Control Unit	630
Sterndrive Steering Systems	049-050, 058-059	Travellers	652-657, 661-662
Sting Ray Hydrofoils	106	Tri-Color Navigation Lamp	381, 383
Strakes	299-305	Trim Boxes	665
Support Struts for Propeller Shafts	577	Trim Gauges	322-324, 326-327
Switch Panels	325, 346-349	Trim Switches	126
Switches	340-345	Trim Systems	100-105
Swivel Haps	285	Trim Tabs	100-105
Swivels	237	Trolling Valves	554
		Tubing for Guard Railing and Grab Rails	284
		Turnbuckles	211, 621
		Twin Halyard Block	646
		Twin Seat for Inflatable Boats	175
		Twisted Shackles Stainless Steel	208
		<b>U</b>	
		U-Bolts (Shroud Plates)	207
		Underwater Lights LED	363, 374-375
		Universal Hose Connectors	607
		Universal Kill Switch Key Sets	117
		Universal Shackle Key	207
<b>T</b>			
Table Pedestals	158-159		
Tables	159		
Tachometers	322-324, 326-327		
Tank Accessories	110-116, 119		
Tank Fixing Braces Stanless Steel	116, 597		
Tank Senders	112, 328-329, 468, 596		
Tank Senders Drinking- & Black Water	112, 329, 468		
Teak Table Tops	159		
Technodrive Marine Reversing Gears	535-547		
Teleopic Boat Chair Pedestals	152, 157, 160-161		

## TABLE OF CONTENTS



USB Charger Plug	344-345, 347	Waterlocks Plastic	603
<b>V</b>		Waterlocks Stainless Steel	601
Vacuum Switch	487	Watertanks Senders	322-324, 326-327
Vacuum Toilets	450-451	Watertanks Stainless Steel & Plastic	116, 471, 597
Valves	459, 463, 470, 604	Watertight Containers	196-197
VeeConnect Digital Switching System NMEA	325	Wave Damping Boat Chair System	155
Veethree Universal Engine Monitor System	324	Wet Notes Ritchie	262
Ventilation	307-309, 609-611	Winch Handles	628-629
Ventilation Hose	308, 610	Winches	622-627
Ventilation Louvres and Grill, Butterfly Vents	308-309, 610-611	Winches Electric	626-627
Ventilation Systems	307-309, 609-611	Winches for Sheets	622-627
Volt Gauges	322-324, 326-327	Wind Indicators	204
Volt Reducer	329	Windlass Accessories	227-228, 230-231
Volvo Saildrive Adapter kits for Solé	524	Windlasses	218-226
Volvo Sterndrive SAE-7 Adapter	550	Windshield Wipers	330-335
<b>W</b>		Wipers	330-335
Wall Lamps	352, 365-367	Wireless Remote Control	092, 227-228, 230
Wash Brushes	190	Wire-Rope Grips	207
Washing Bowls	435, 438-439	Wobble Rollers	186
Waste Water Discharge Deck Plate	455	<b>X</b>	
Waste Water Tank Senders	112, 329, 468	Xenon Search Light	387
Waste Water Tanks (sets)	456-457	X-Force Bow Thrusters	090-093
Water Hose	464-465, 607-608	<b>Y</b>	
Water Pressure Systems	478-481	Y-Connectors	463
Water Scoop Kits	575	<b>Z</b>	
Water Ski Accessories	188	Zinc Anodes	128-137
Water Ski Mirror	188		
Water Ski Rope	188		
Water Sports Helmet	256		
Water Taps	441-443		
Water Temperature Gauges	322-324, 326-327		
Water Tubing System SeaTech	466-467		
Water/Gas Separator	602		
Waterlocks	601-603		



# 01

from page 22  
to page 35



# 02

from page 35  
to page 64



# 03

from page 64  
to page 71



# 04

from page 71  
to page 90

# 05

from page 90  
to page 96



# 06

from page 96  
to page 100



# 07

from page 100  
to page 134



# 08

from page 134  
to page 172







# 09

from page 172  
to page 182



# 10

from page 182  
to page 190



# 11

from page 190  
to page 222



# 12

from page 222  
to page 249

# 13

from page 249  
to page 276



# 14

from page 276  
to page 294



# 15

from page 294  
to page 322



# 16

from page 322  
to page 335





17

from page 335  
to page 380



18

from page 380  
to page 400



19

from page 400  
to page 408



20

from page 408  
to page 437

# 21

from page 437  
to page 450



# 22

from page 450  
to page 474



# 23

from page 474  
to page 496



# 24

from page 496  
to page 526

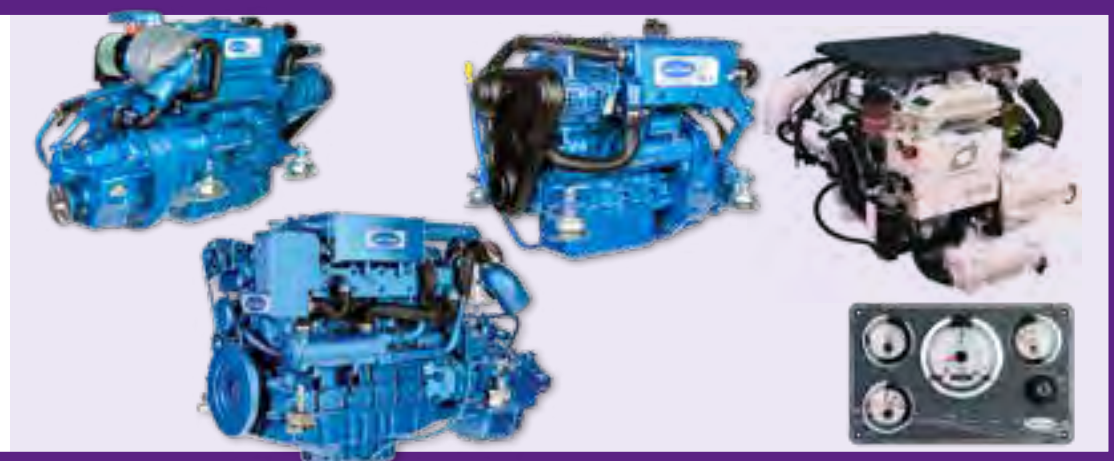



**25**

from page 526  
to page 548



**26**

from page 548  
to page 571



**27**

from page 571  
to page 582



**28**

from page 582  
to page 601

# 29

from page 601  
to page 607



# 30

from page 607  
to page 615



# 31

page 615



# 32

from page 616  
to page 666

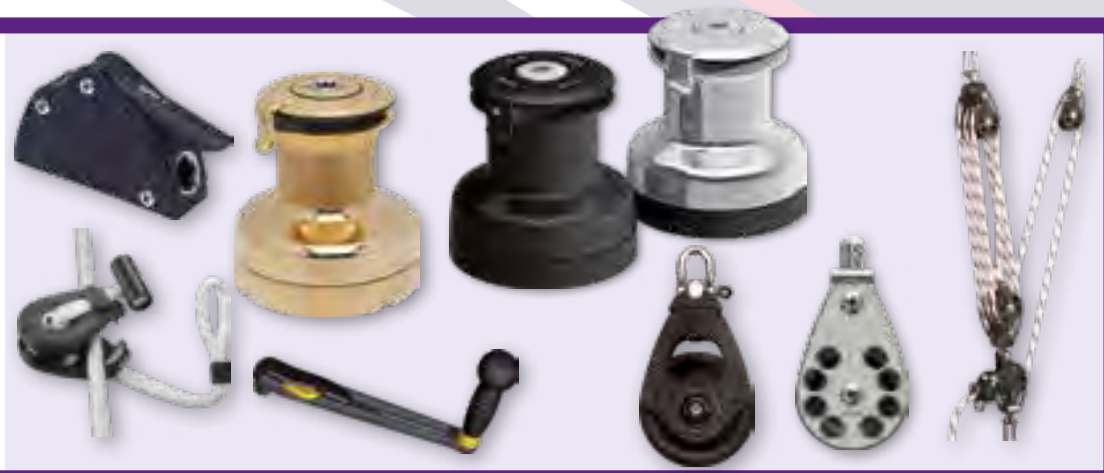

page 455



page 227



page 406



page 106



page 108



page 348



page 337



page 341



page 445



page 398



page 61



page 256



page 155



page 255



page 227



page 256



page 114



page 324

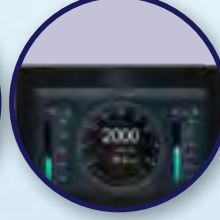

page 273



page 254

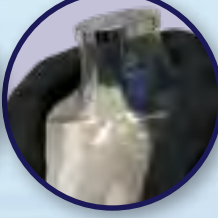

page 173



page 117



page 116



page 187



page 154



page 337

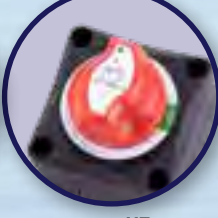

page 343



page 94



page 385



page 255

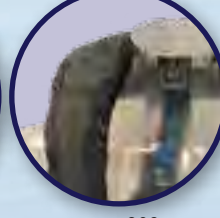

page 374



page 117



page 219



page 325



page 343



page 382



# NEW PRODUCTS

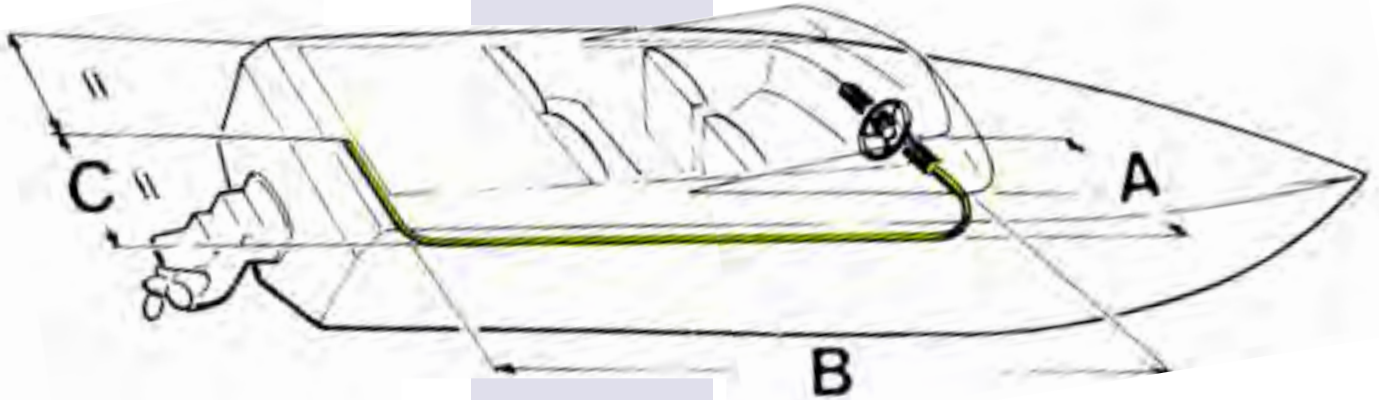
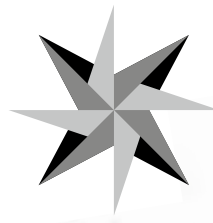

**NEW INSTALLATION:**

Measure cable route path from wheel centre line to engine connection, as follows:

- For Cable Installations through the Engine Tilt Tube: Add A, B & C + 150mm (6”), then round up to the next foot. Order that length of cable.
- For Cables Mounted to Transom, Splashwell or Stringer: Add A, B & C - 150mm (6”) and round up to the next foot. Order that length of cable.

**How to Measure Steering Cables  
“Measure Twice. Order Once”**

**Replacement of existing cable:**

If possible, find the part number stamped on the plastic jacket of the old cable. If you remove the old cable, measure for the replacement cable as follows:

**For rotary steering cable replacement (SSC131, SSC290, SSC62 and SSCX64):**

Measure plastic cable jacket in millimetres, add 460mm (18”), and round up to next foot. Order that length of cable.

**For rack steering cable replacement (SSC124 and SSC134):**

Measure plastic cable jacket in millimetres, add 760mm (30”), and round up to next foot. Order that length of cable.



**New installation throttle and shift cables outboards:**

- Measure from control along unobstructed cable routing to shift and/or throttle connection.
- Add 610 mm (6 ft)
- Round up to the next foot. Order that length of cable.

**How to Measure Control Cables**

**Inboards & sterndrives:**

- Measure from control along unobstructed cable routing to shift and/or throttle connection.
- Round up to the next foot.

**Replacement of existing cable:**

Measure Existing Cable from tip to tip and round up to the next foot.

Order that length of cable. To convert to feet, divide measured length (mm) by 305. Round up to next foot.







**SEASTAR**

By **DOMETIC**

**Steering kit complete in box, consisting of:**

Helm, Bezel + Mounting Hardware and Cable.

Item Code		Length ft.	Length cm
SS13806/Z	Incl. cable	06	183
SS13807/Z	Incl. cable	07	213
SS13808/Z	Incl. cable	08	244
SS13809/Z	Incl. cable	09	274
SS13810/Z	Incl. cable	10	305
SS13811/Z	Incl. cable	11	335
SS13812/Z	Incl. cable	12	366
SS13813/Z	Incl. cable	13	396
SS13814/Z	Incl. cable	14	427
SS13815/Z	Incl. cable	15	457
SS13816/Z	Incl. cable	16	488
SS13817/Z	Incl. cable	17	518
SS13818/Z	Incl. cable	18	549
SS13819/Z	Incl. cable	19	579
SS13820/Z	Incl. cable	20	610
SS13821/Z	Incl. cable	21	641
SS13822/Z	Incl. cable	22	671
SS13823/Z	Incl. cable	23	702
SS13824/Z	Incl. cable	24	732
SS13825/Z	Incl. cable	25	763
SS13826/Z	Incl. cable	26	793

**FEATURES:**

- Light duty steering system
- Comfortable 2.5 turns from lock-to-lock
- With friction brake
- Standard 3/4" tapered steering shaft
- 90° Bezel
- Corrosion resistant
- Max. wheel diameter 380mm
- Min. cable radius 200mm

**SeaStar Steering Systems**  
 are in conformity with CE/N.M.M.A./  
 ISO 9775/ISO 8848/A.B.Y.-C.-P17- standards.

**Item Code SH8050** Steering helm(including bezel)

**Item Code SSC131xx** Steering cable

(xx = cable length feet. A 12' cable would be **SSC13112**)

**Steering wheels:** from page 66.

Steering Kit including wheel:

Item Code SS13806, SS13807 et cetera.



**Compac-T  
 Rotary Outboard  
 Light Duty  
 Steering up to  
 40kW / 55hp**

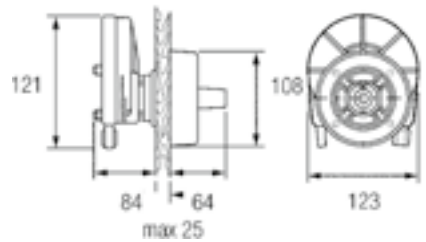
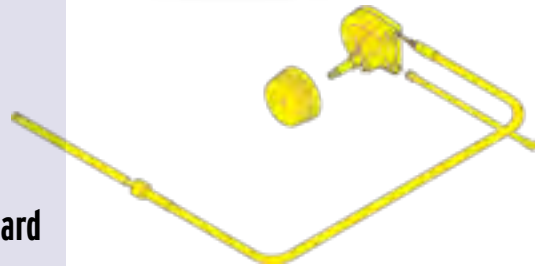

Connection Kits section: See page 33-34



SA27017 / SA27299



SA27255 / SA27256



SA27253 / SA27254

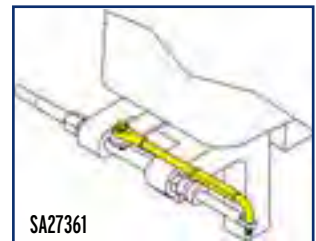

SA27361

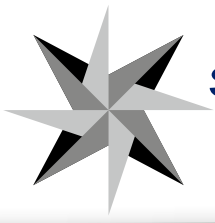

SEASTAR

By DOMETIC

Set complete with tilt helm



**Mechanical Steering Safe-T Quick Connect „Tilt“ up to 173kW/235hp**

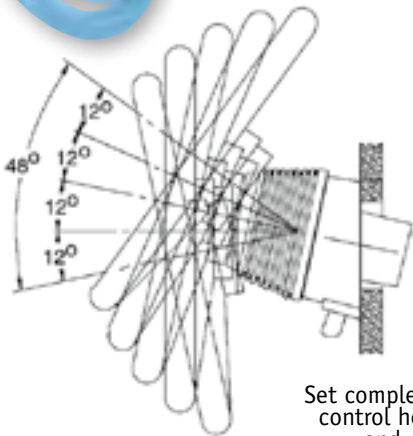

Set complete in box includes: control head, mounting kit and control cable.

Connection Kits section: See page 33-34



SA27017 / SA27299

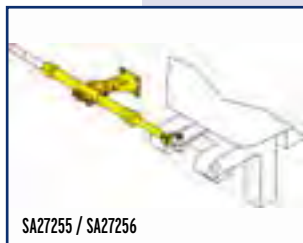

SA27255 / SA27256

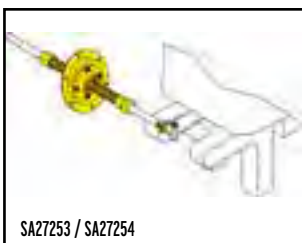

SA27253 / SA27254

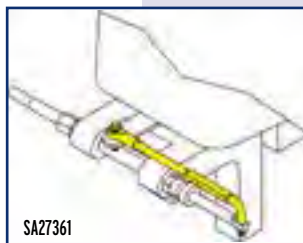

SA27361

Item		Length ft.	Length cm
SS13906	Incl. cable	06	183
SS13907	Incl. cable	07	213
SS13908	Incl. cable	08	244
SS13909	Incl. cable	09	274
SS13910	Incl. cable	10	305
SS13911	Incl. cable	11	335
SS13912	Incl. cable	12	366
SS13913	Incl. cable	13	396
SS13914	Incl. cable	14	427
SS13915	Incl. cable	15	457
SS13916	Incl. cable	16	488
SS13917	Incl. cable	17	518
SS13918	Incl. cable	18	549
SS13919	Incl. cable	19	579
SS13920	Incl. cable	20	610
SS13921	Incl. cable	21	641
SS13922	Incl. cable	22	671
SS13923	Incl. cable	23	702
SS13924	Incl. cable	24	732
SS13925	Incl. cable	25	763
SS13926	Incl. cable	26	793
SS13927	Incl. cable	27	823
SS13928	Incl. cable	28	854
SS13929	Incl. cable	29	884
SS13930	Incl. cable	30	915

SeaStar Steering Systems are in conformity with CE/N.M.M.A./ ISO 9775/ISO 8848/A.B.Y.-C.-P17- standards.

**FEATURES:**

- 5 Steering wheel locking positions
- Suits most outboard and power assisted stern drive applications
- Fast, easy installation: uses Teleflex-Marine Quick Connect (QC) steering cable
- 3.0 turns from lock-to-lock
- With friction brake
- Standard 3/4" tapered steering shaft
- Corrosion resistant
- Max. wheel diameter 408mm
- Min. cable radius 200mm

**COMPONENTS:**

- Item Code SH91523-1** Safe-T QC Tilt Steering helm
- Item Code SH91800** „Tilt-Sport“ mechanism
- Item Code SH91900** „Tilt-Sport-Plus“ mechanism
- Item Code SSC62xx** Steering cable

(xx = cable length in ft. A 12 feet cable would be SSC6212)

Steering wheels: from page 66.



SH91800

## Steering kit complete in box, consisting of:

Helm, Bezel + Mounting Hardware and Cable

Item Code		Length ft.	Length cm
SS13706	Incl. cable	06	183
SS13707	Incl. cable	07	213
SS13708	Incl. cable	08	244
SS13709	Incl. cable	09	274
SS13710	Incl. cable	10	305
SS13711	Incl. cable	11	335
SS13712	Incl. cable	12	366
SS13713	Incl. cable	13	396
SS13714	Incl. cable	14	427
SS13715	Incl. cable	15	457
SS13716	Incl. cable	16	488
SS13717	Incl. cable	17	518
SS13718	Incl. cable	18	549
SS13719	Incl. cable	19	579
SS13720	Incl. cable	20	610
SS13721	Incl. cable	21	641
SS13722	Incl. cable	22	671
SS13723	Incl. cable	23	702
SS13724	Incl. cable	24	732
SS13725	Incl. cable	25	763
SS13726	Incl. cable	26	793
SS13727	Incl. cable	27	823
SS13728	Incl. cable	28	854
SS13729	Incl. cable	29	884
SS13730	Incl. cable	30	915

### FEATURES:

Ideal for traditional boat applications

- Suits most outboard and power assisted stern drive applications
- 3.0 turns from lock-to-lock
- With friction brake
- Standard 3/4" tapered steering shaft
- 90° Bezel (20° bezel optional)
- Corrosion resistant
- Max. wheel diameter 408mm
- Min. cable radius 200mm

### COMPONENTS:

Item Code SH5094-1 Steering helm

Item Code SB27484 90° Bezel

(with brake: Item Code SB27486)

Item Code SSC62xx Steering cable: please specify length required

### OPTIONS:

Item Code SB27483 20° Bezel

(with brake: Item Code SB27485)

Item Code SH91523-1 „Tilt“-helm (+SH91800) of SH91900

Item Code SH91800 „Tilt“-Sport mechanism

Item Code SH91900 „Tilt“-Sport plus mechanism

Item Code SH4952 „Twin“ 4.2 Rotary, without NFB

Steering wheels: from page 66.

SH91800



Twin helm with dual cable available for applications with engine flutter or steering instability.

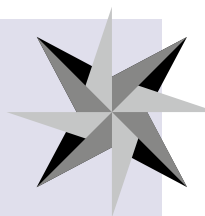

# SEASTAR

By **DOMETIC**



## Safe-T QC Rotary Steering System up to 173kW/235hp

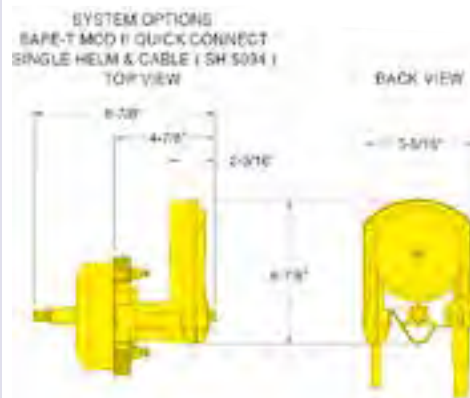

Connection Kits section: See page 33-34



SA27017 / SA27299

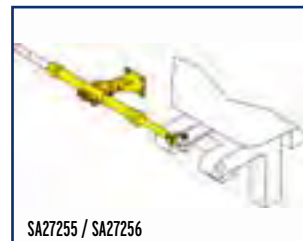

SA27255 / SA27256



SA27253 / SA27254

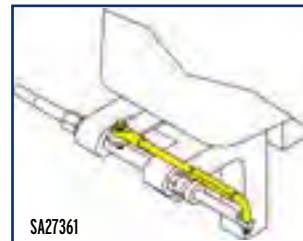

SA27361



**SEASTAR**

By **DOMETIC**

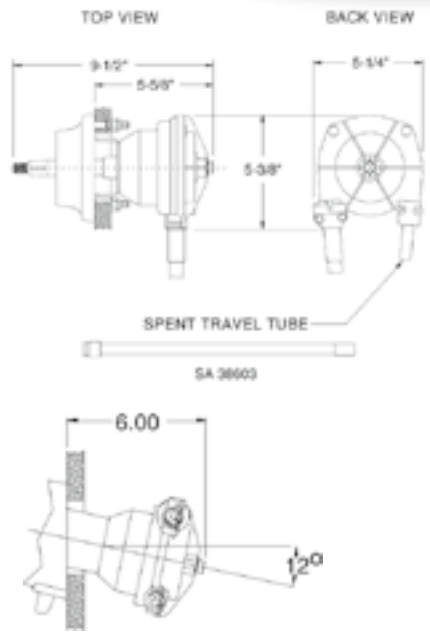

**Mechanical Steering „SAFE-T II“ (NO-FEEDBACK) up to 173kW/ 235hp**

Connection Kits section: See page 33-34

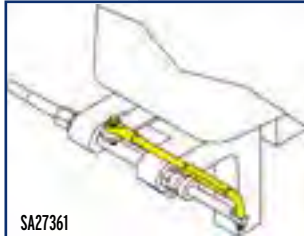
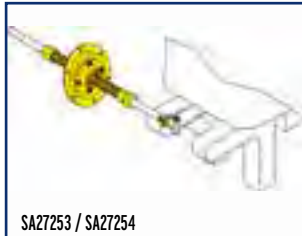

**Steering kit complete in box, consisting of:**  
Helm, Bezel + Mounting Hardware and Cable

Item Code		Length ft	Length cm
SS13206	Incl. cable	06	183
SS13207	Incl. cable	07	213
SS13208	Incl. cable	08	244
SS13209	Incl. cable	09	274
SS13210	Incl. cable	10	305
SS13211	Incl. cable	11	335
SS13212	Incl. cable	12	366
SS13213	Incl. cable	13	396
SS13214	Incl. cable	14	427
SS13215	Incl. cable	15	457
SS13216	Incl. cable	16	488
SS13217	Incl. cable	17	518
SS13218	Incl. cable	18	549
SS13219	Incl. cable	19	579
SS13220	Incl. cable	20	610
SS13221	Incl. cable	21	641
SS13222	Incl. cable	22	671
SS13223	Incl. cable	23	702
SS13224	Incl. cable	24	732
SS13225	Incl. cable	25	763
SS13226	Incl. cable	26	793
SS13227	Incl. cable	27	823
SS13228	Incl. cable	28	854
SS13229	Incl. cable	29	884
SS13230	Incl. cable	30	915

**SeaStar Steering Systems are in conformity with CE/N.M.M.A./ ISO 9775/ISO 8848/A.B.Y.-C.-P17- standards.**

**FEATURES:**

- Fast, easy installation: uses Teleflex-Marine Quick Connect (QC) steering cable
- 3.2 turns from lock-to-lock
- Standard 3/4" tapered steering shaft
- Planetary wheels with centralized steering shaft
- 90° Bezel (20° bezel optional)
- Corrosion resistant
- Max. wheel diameter 40°mm
- Min. cable radius 200mm

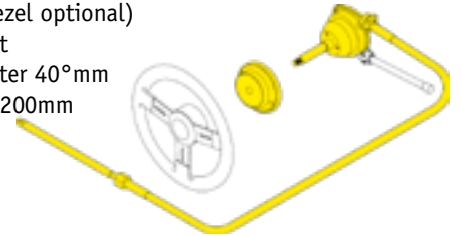

**COMPONENTS:**

Item Code SH5150	NFB 4.2 Steering helm
Item Code SB27150	90° Bezel
Item Code SSC62xx	Steering cable (Please spec. length required)

(xx = cable length in ft. A 14' cable would be SSC6214)

**OPTIONAL:**

Item Code SB27483	20° Bezel
Item Code SH91190	"Tilt"- helm (order with SH91800 or SH91900)
Item Code SH91800	"Tilt"- Sport mechanism
Item Code SH91900	"Tilt"- Sport Plus mechanism

Steering wheels: from page 66.

SH91800



**NFB: NO-FEEDBACK**  
Locks out the torque felt at the wheel generated by the rotation of the propeller. Suitable for non-power assisted applications and only 1 helm position. Replaces standard SAFE-T® steering without dash modifications.

**Steering kit complete in box, consisting of:**

Helm, Bezel + Mounting Hardware and Cable

Item Code		Length ft.	Length cm
SS14706	Incl. cable	06	183
SS14707	Incl. cable	07	213
SS14708	Incl. cable	08	244
SS14709	Incl. cable	09	274
SS14710	Incl. cable	10	305
SS14711	Incl. cable	11	335
SS14712	Incl. cable	12	366
SS14713	Incl. cable	13	396
SS14714	Incl. cable	14	427
SS14715	Incl. cable	15	457
SS14716	Incl. cable	16	488
SS14717	Incl. cable	17	518
SS14718	Incl. cable	18	549
SS14719	Incl. cable	19	579
SS14720	Incl. cable	20	610
SS14721	Incl. cable	21	641
SS14722	Incl. cable	22	671
SS14723	Incl. cable	23	702
SS14724	Incl. cable	24	732
SS14725	Incl. cable	25	763
SS14726	Incl. cable	26	793
SS14727	Incl. cable	27	823
SS14728	Incl. cable	28	854
SS14729	Incl. cable	29	884
SS14730	Incl. cable	30	915

**SeaStar Steering Systems  
are in conformity with CE/N.M.M.A./**

**ISO 9775/ISO 8848/A.B.Y.-C.-P17- standards.**

**FEATURES:**

- Fast, easy installation: uses Teleflex-Marine Quick Connect (QC) steering cable
- 4.2 turns from lock-to-lock
- Easy steering due to 22:1 ratio
- Standard 3/4" tapered steering shaft
- 90° Bezel (20° bezel optional)
- Corrosion resistant
- Max. wheel diameter 408mm
- Min. cable radius 200mm

**SEPERATE PARTS:**

**Item Code SH4910** NFB4.2 Steering helm

**Item Code SB27150** 90° Bezel

**Item Code SSC62x** Steering cable

(Please spec. length required)

**OPTIONAL :**

**Item Code SB27483** 20° Bezel

**Item Code SH4920** Safe-T QC Twin Helm

**Item Code SH91526** "Tilt"-helm (order with **SH91800** or **SH91900**)

**Item Code SH91527** "Twin/Tilt" helm (order with **SH91800** or **SH91900**)

**Item Code SH91800** "Tilt"- Sport mechanism

**Item Code SH91900** "Tilt"- Sport-Plus mechanism

Steering wheels: from page 66.

SH91800



**NFB: NO-FEEDBACK**

**Locks out the torque felt at the wheel generated by the rotation of the propeller. Suitable for non-power assisted applications and only 1 helm position.**

**Replaces standard SAFE-T® steering without dash modifications.**

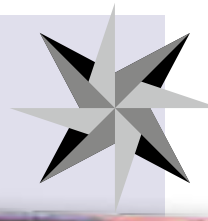

**SEASTAR**

By **DOMETIC**

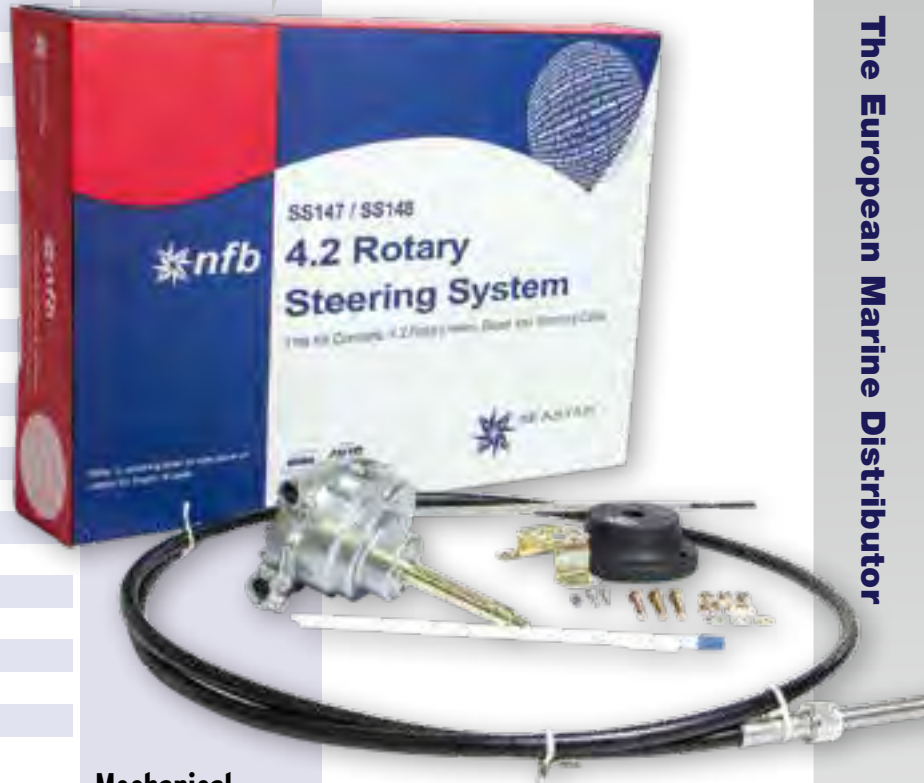

**Mechanical steering „NFB“ (NO-FEEDBACK) „4.2 ROTARY“ up to 173kW/ 235hp**

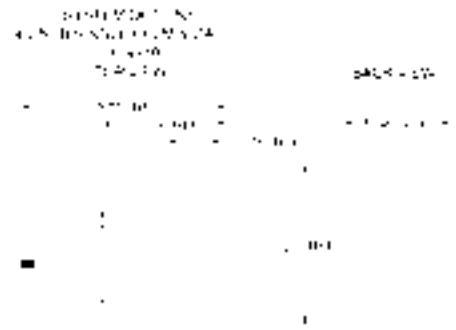

Connection Kits section: See page 33-34



SA27017 / SA27299

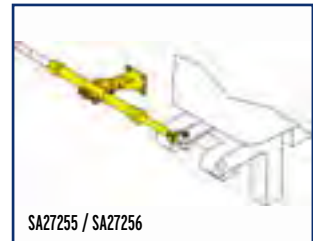

SA27255 / SA27256

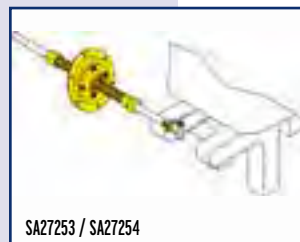

SA27253 / SA27254

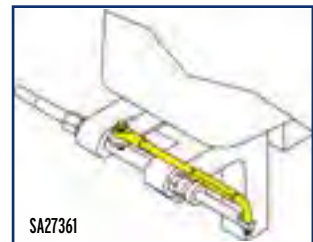

SA27361

**Twin helm with dual cable available for applications with engine flutter or steering instability.**

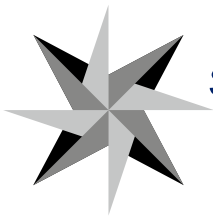

SEASTAR

By  DOMETIC

**Mechanical  
Steering  
„The Rack“  
up to 173kW/  
235hp**



### Steering kit complete in box, consisting of:

Helm, Bezel + Mounting Hardware and Cable

Item Code		Length ft.	Length cm
SS14106	Incl. cable	6	183
SS14107	Incl. cable	7	213
SS14108	Incl. cable	8	244
SS14109	Incl. cable	9	274
SS14110	Incl. cable	10	305
SS14111	Incl. cable	11	335
SS14112	Incl. cable	12	366
SS14113	Incl. cable	13	396
SS14114	Incl. cable	14	427
SS14115	Incl. cable	15	457
SS14116	Incl. cable	16	488
SS14117	Incl. cable	17	518
SS14118	Incl. cable	18	549
SS14119	Incl. cable	19	579
SS14120	Incl. cable	20	610
SS14121	Incl. cable	21	640
SS14122	Incl. cable	22	671
SS14123	Incl. cable	23	701
SS14124	Incl. cable	24	732
SS14125	Incl. cable	25	762
SS14126	Incl. cable	26	793
SS14127	Incl. cable	27	823
SS14128	Incl. cable	28	854
SS14129	Incl. cable	29	884
SS14130	Incl. cable	30	915

**SeaStar Steering Systems  
are in conformity with CE/N.M.M.A./  
ISO 9775/ISO 8848/A.B.Y.-C.-P17- standards.**

#### FEATURES:

- 3.5 turns from lock-to-lock
- Standard 3/4" tapered steering shaft
- Planetary wheels with centralized steering shaft
- 90° Bezel (20° or 10° bezel optional)
- Corrosion resistant
- Max. wheel diameter 408mm
- Min. cable radius 200mm

#### COMPONENTS:

<b>Item Code SH5210</b>	Rack Basic steering helm
<b>Item Code SSC134xx</b>	Steering cable: Length in ft.
<b>Item Code SB39526</b>	90° Bezel

#### OPTIONS

<b>Item Code SH91610</b>	Rack „Tilt“-helm (+SH91800 of SH91900)
<b>Item Code SH91800</b>	„Tilt“-Sport mechanism
<b>Item Code SH91900</b>	„Tilt“-Sport plus mechanism

Steering wheels: from page 66.

Connection Kits section: See page 33-34



SA27017 / SA27299



SA27255 / SA27256

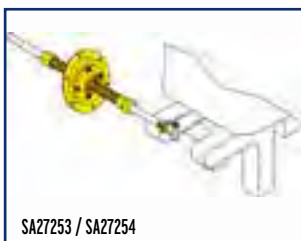

SA27253 / SA27254

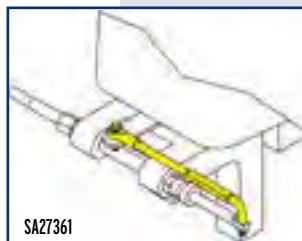

SA27361

**Steering kit complete in box, consisting of:**

Helm, Bezel + Mounting Hardware and Cable

Item Code		Length ft.	Length cm
SS15106	Incl. cable	6	183
SS15107	Incl. cable	7	213
SS15108	Incl. cable	8	244
SS15109	Incl. cable	9	274
SS15110	Incl. cable	10	305
SS15111	Incl. cable	11	335
SS15112	Incl. cable	12	366
SS15113	Incl. cable	13	396
SS15114	Incl. cable	14	427
SS15115	Incl. cable	15	457
SS15116	Incl. cable	16	488
SS15117	Incl. cable	17	518
SS15118	Incl. cable	18	549
SS15119	Incl. cable	19	579
SS15120	Incl. cable	20	610
SS15121	Incl. cable	21	640
SS15122	Incl. cable	22	671
SS15123	Incl. cable	23	701
SS15124	Incl. cable	24	732
SS15125	Incl. cable	25	762
SS15126	Incl. cable	26	793
SS15127	Incl. cable	27	823
SS15128	Incl. cable	28	854
SS15129	Incl. cable	29	884
SS15130	Incl. cable	30	915

**SeaStar Steering Systems**  
are in conformity with CE/N.M.M.A./  
ISO 9775/ISO 8848/A.B.Y.-C.-P17- standards.

**FEATURES:**

- 3.5 turns from lock-to-lock
- Standard 3/4" tapered steering shaft
- Planetary wheels with centralized steering shaft
- 90° Bezel (20° or 10° bezel optional)
- Corrosion resistant
- Max. wheel diameter 408mm
- Min. cable radius 200mm

**COMPONENTS:**

- Item Code SH5230** NFB Rack Steering helm  
**Item Code SSC134xx** Steering cable  
 (xx = cable length in ft. A 14' cable would be SSC13414)  
**Item Code SB39544** 90° Bezel

**OPTIONS**

- Item Code SB27448** 10° Bezel\*  
**Item Code SB27449** 20° Bezel\*  
**Item Code SH91630** „Tilt“-helm (+SH91800 of SH91900)  
**Item Code SH91800** „Tilt“-Sport mechanism  
**Item Code SH91900** „Tilt“-Sport plus mechanism

\* In combination with 90° bezel!

Steering wheels: from page 66.

SH91800



**NO-FEEDBACK:**

**Locks out the torque felt at the wheel generated by the rotation of the propeller.**  
**Suitable for non-power assisted applications and only 1 helm position.**  
**Replaces "Rack-T"-Steering (1984-1996).**

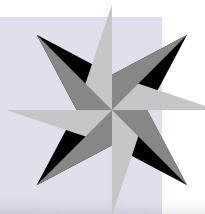

**SEASTAR**

By **DOMETIC**



**NFB Rack and Pinion Mechanical Steering up to 173kW/235hp**

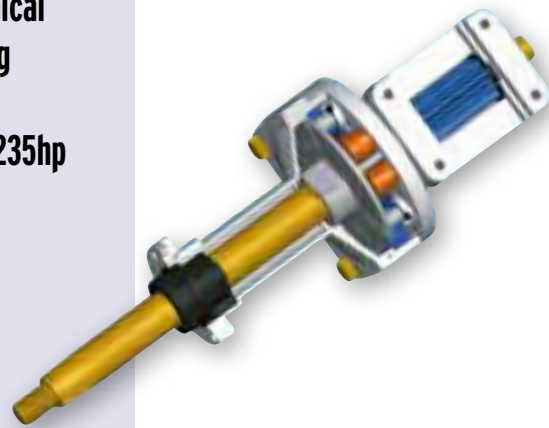

Connection Kits section: See page 33-34



SA27017 / SA27299

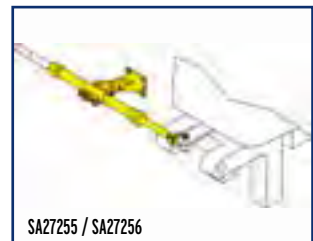

SA27255 / SA27256



SA27253 / SA27254

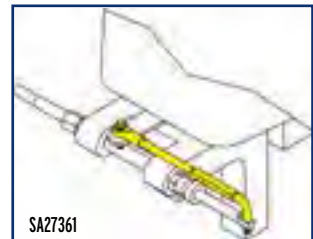

SA27361



SEASTAR

By DOMETIC

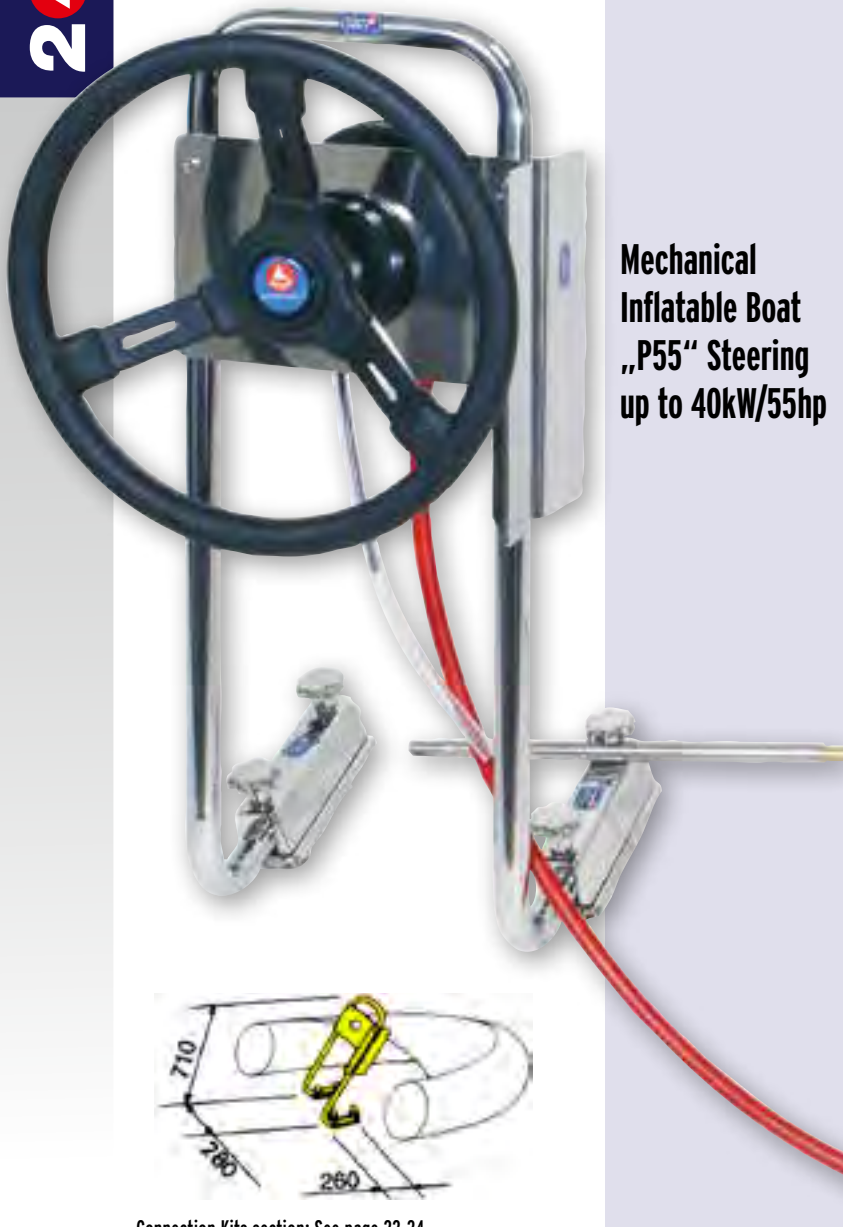

**Mechanical  
Inflatable Boat  
„P55“ Steering  
up to 40kW/55hp**



Connection Kits section: See page 33-34



SA27017 / SA27299



SA27255 / SA27256

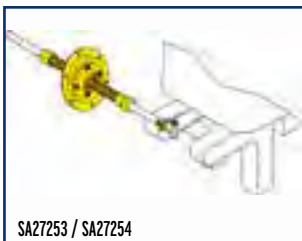

SA27253 / SA27254

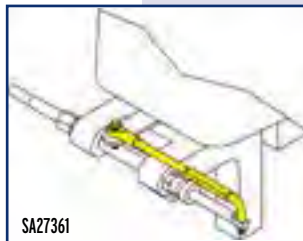

SA27361

**Steering kit complete in box, consisting of:**

Stainless Steel Bracket with Mounting Plate for Motor Control, Helm, Bezel + Mounting Hardware, Cable and Wheel

Item Code		Length ft.	Length cm
P5506	Incl. cable	06	183
P5507	Incl. cable	07	213
P5508	Incl. cable	08	244
P5509	Incl. cable	09	274
P5510	Incl. cable	10	305
P5511	Incl. cable	11	335
P5512	Incl. cable	12	366
P5513	Inkl. Cable	13	396
P5514	Incl. cable	14	427
P5515	Incl. cable	15	457
P5516	Incl. cable	16	488
P5517	Incl. cable	17	518
P5518	Incl. cable	18	549
P5519	Incl. cable	19	579
P5520	Incl. cable	20	610

**SeaStar Steering Systems  
are in conformity with CE/N.M.M.A./  
ISO 9775/ISO 8848/A.B.Y.-C.-P17- standards.**

**FEATURES:**

- Light duty steering system
- Floor mount steering system for inflatables and polyester boats
- Comfortable 2.5 turns from lock-to-lock
- With friction brake
- Standard 3/4" tapered steering shaft
- 90° Bezel
- Corrosion resistant
- Max. wheel diameter 380mm
- Min. cable radius 200mm

**COMPONENTS:**

- Item Code 36141** S/S Bracket P-55
- Item Code SH8050** Steering helm(including bezel)
- Item Code SSC131xx** Steering cable
- Item Code 062100** Steering wheel Riviera



**allpa**  
marine equipment



**Steering kit complete in box, consisting of:**

Helm, Bezel 90° + Mounting Hardware and Xtreme™ Cable

Item Code		Length ft.	Length cm
SSX17508	Incl. cable	08	244
SSX17509	Incl. cable	09	274
SSX17510	Incl. cable	10	305
SSX17511	Incl. cable	11	335
SSX17512	Incl. cable	12	366
SSX17513	Incl. cable	13	396
SSX17514	Incl. cable	14	427
SSX17515	Incl. cable	15	457
SSX17516	Incl. cable	16	488
SSX17517	Incl. cable	17	518
SSX17518	Incl. cable	18	549
SSX17519	Incl. cable	19	579
SSX17520	Incl. cable	20	610
SSX17521	Incl. cable	21	641
SSX17522	Incl. cable	22	671
SSX17523	Incl. cable	23	702
SSX17524	Incl. cable	24	732
SSX17525	Incl. cable	25	763
SSX17526	Incl. cable	26	793
SSX17527	Incl. cable	27	823
SSX17528	Incl. cable	28	854
SSX17529	Incl. cable	29	884
SSX17530	Incl. cable	30	915

**Xtreme™ Steering system with No-Feedback:  
Please use Item Code SSX176xx + length in feet (ft)**

**SeaStar Steering Systems  
are in conformity with CE/N.M.M.A./  
ISO 9775/ISO 8848/A.B.Y.-C.-P17- standards.**

**FEATURES:**

- Smoothest and lowest steering effort mechanical helm offered in the market place:
- 30% less effort compared to 4.2 NFB helm, less backlash, improved NFB-clutch and en super smooth XTREME™ cable SSCX64 with splined liner
- Small installation footprint fits standard Teleflex dash cut out
- "QUICK CONNECT" feature on both cable and spent travel tube for easy quick installation
- Corrosion resistant
- 5 turns from lock-to-lock
- Max. wheel diameter: 16" (408mm)
- Max. wheel dish: 5" (127mm)
- Min. cable radius: 200mm

**COMPONENTS:**

<b>Item Code SHX7626</b>	XTREME™ Non-NFB Helm incl. Bezel kit 90° (Item Code SBX76261)
<b>Item Code SHX7606</b>	XTREME™ NFB Helm incl. Bezel kit 90° (Item Code SBX76061)
<b>Item Code SSCX64xx</b>	XTREME™ Steering cable (xx = cable length in feet. A 12 feet cable would be SSCX6412)
<b>Item Code SB27483</b>	Loose Bezel kit 90°

Steering wheels: from page 66.

**NO-FEEDBACK**  
Locks out the torque felt at the wheel generated by the rotation of the propeller.  
Suitable for non-power assisted applications and only 1 helm position.



**Stuursysteem  
„XTREME™“  
Standaard en  
NFB  
tot 173kW/235pk**



Connection Kits section: See page 33-34



SA27017 / SA27299

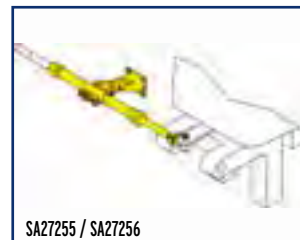

SA27255 / SA27256

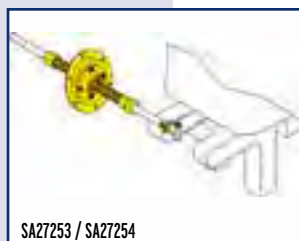

SA27253 / SA27254

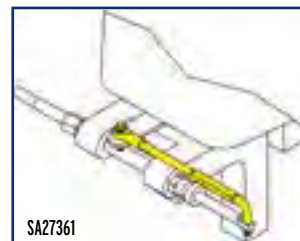

SA27361

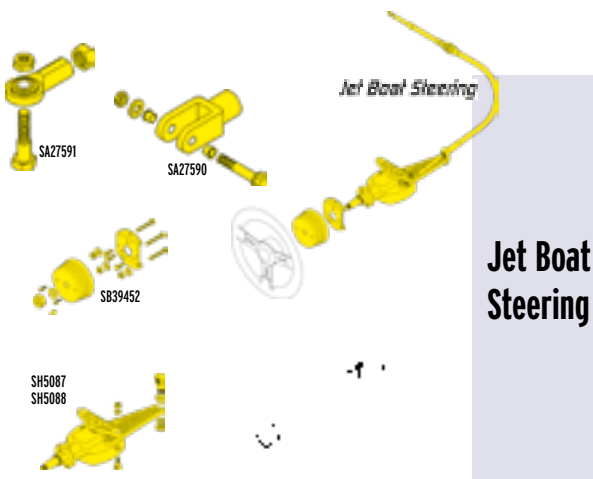

**Jet Boat Steering**

This steering system is not available as a complete kit. System components sold separately. Note engine type and steering arc to select items from the list below.

- Item Code SSC219** Steering cable
- Item Code SH5087** BS Helm 135° turning arc
- Item Code SH5088** JBS Helm 270° turning arc
- Item Code SB39452** JBS Bezel & Mounting hardware kit
- Item Code SA27591** Nozzle connection kit (Mercury®)
- Item Code SA27590** Nozzle connection kit (OMC®)

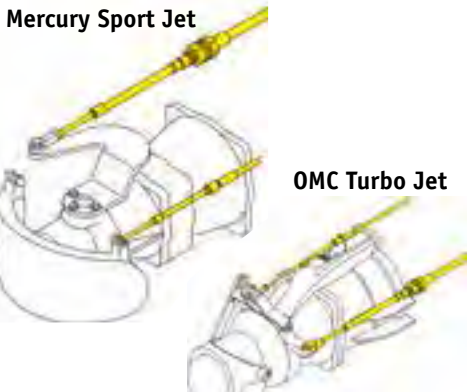

**Jet Boat Steering**



**Jet Boat control**



This system controls throttle and gate.

- Item Code CH2300** Jet Boat Engine Control
- Item Code CC230xx** Mercury Sport Jet® Throttle cable \* #
- Item Code CC205xx** OMC Turbo Jet® Throttle cable ##
- Item Code CC214xx** OMC Turbo Jet® Gate cable ##

\* may require purchase of cable connection kit(s) to complete control system installation.  
 # for Mercury/OMC binnacle mount /other controls that accept a 10-32 threaded end.  
 ## for OMC side mount controls that accept OMC "snap-in" O.E.M. type cable.

**Features:**

- 135° or 270° turning arc lock-to-lock.
- Uses a true steering cable (increased cable strength with stainless steel inner core and output ends).
- Corrosion proof.
- Easy to install and very rugged.
- 90° or 180° cable entry into helm.
- Built-in steering stops prevent additional cable stress in hard over positions.
- Meets A.B.Y.C./N.M.M.A. requirements.

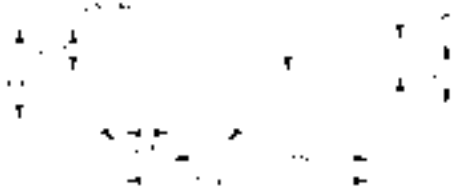
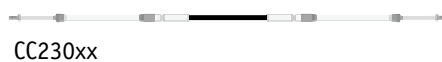

CH2300

- Item Code A344** Ball-joint with 10mm inner thread  
Corrosion resistant
- Item Code A375** Clevis for cables with bolt  
Corrosion resistant
- Item Code A322** Clevis with 10mm inner thread  
Corrosion resistant
- Item Code SA27252** s/s Universal tie bar kit with ball-joints  
Max. length 648mm
- Item Code SA27620** Quick Connect Helm Converter  
For helms with threaded spigots. Up grades older Teleflex (SSC72) rotary helms to Quick-Connect cable (SSC62) interface  
Also for Ultraflex®helms T71-72-73-74

For engines without tilt tube we supply this compact mounting kit which is very suitable for narrow transoms:

- Item Code A260** Support tube transom mount  
Corrosion resistant
- Item Code A275** Complete s/s link arm with ball-joint

### Connection Kits

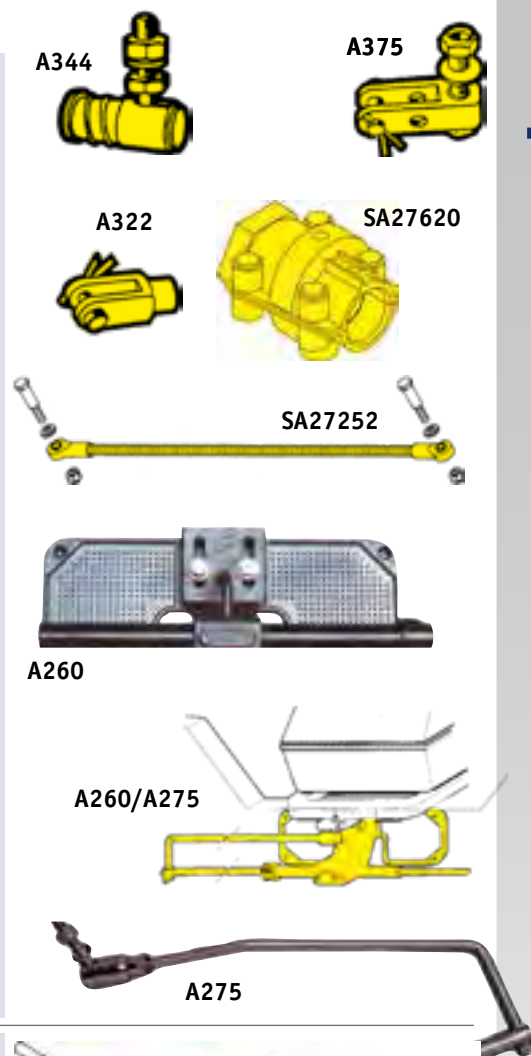

- Item Code SA27256** All corrosion resistant material and s/s clevis.
- Item Code SA27255** All stainless steel material.

### Transom Support Mounting



- Item Code SA27361** Universal Link Arm  
L=HtH 275 mm

### Universal link arm

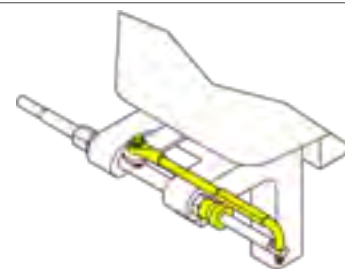

- Item Code SA27253** Splashwell Mounting 15°  
Flange Ø150mm.
- Item Code SA27254** Splashwell Mounting 90°  
Flange Ø95mm.

### Splashwell mounting kit

Complete with corrosion resistant ball and support tube and stainless steel clevis.

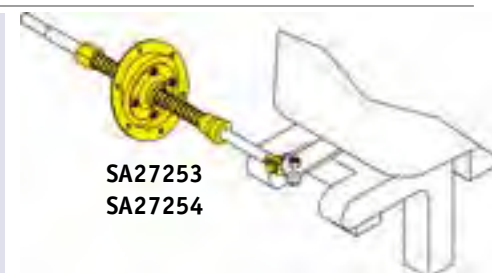

- Item Code SA27017** All corrosion resistant material and s/s clevis. Long post (114mm/4.5") stand off.
- Item Code SA27299** All corrosion resistant material and s/s clevis. Short post (63mm/2.25") stand off.

### Inboard Stringer Support Mounting

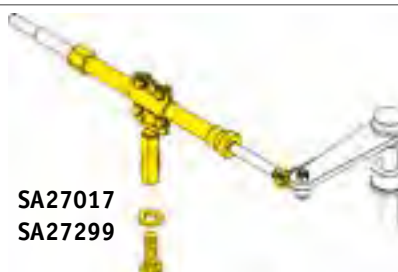

	<b>Cable Guard</b>	<b>Item Code SA39329</b> Cable Guard for most outboards with tilt tube (keeps tilt tube clean)
	<b>Spent travel tube</b>	<b>Item Code SA35680</b> Spent travel tube for rotary helms Safe-T QC/Safe-T/Big-T
	<b>Spent travel tube</b>	<b>Item Code SA38603</b> Spent travel tube for rotary helms NFB 4.2/NFB Safe-T II/HPS
	<b>Hardware kit</b>	<b>Item Code SA27454</b> Steering wheel hardware kit rotary helms For all Teleflex mechanical helms with 3/4" tapered shaft NOT FOR SH8050
	<b>Hitch Pin</b>	<b>Item Code SA27245</b> Hitch pin for Quick Connect helms
	<b>Spare aluminum tube</b>	L=267mm <b>Item Code SA36316</b> Splashwell threaded tube with ball Corrosion resistant <b>Item Code SA37868 end cap, to be ordered separately</b>
	<b>Spare aluminum tube</b>	<b>Item Code SA27274</b> Support tube aluminum Corrosion resistant <b>Item Code SA27275</b> Support tube stainless steel
	<b>Clamp block</b>	<b>Item Code SA27578</b> Clamp block short post 63mm/2-1/4" Corrosion resistant
	<b>Clamp block</b>	<b>Item Code SA27579</b> Clamp block long post 114mm/4-1/2" Corrosion resistant)
	<b>Clevis kit</b>	<b>Item Code SA27314</b> Stainless steel clevis kit, with short bolt <b>Item Code SA27329</b> Stainless steel clevis kit, with long bolt
	<b>Clevis kit</b>	<b>Item Code SA27576</b> Stainless steel clevis kit – ski boat, with short bolt <b>Item Code SA27577</b> Stainless steel clevis kit – ski boat, with long bolt
	<b>Bushing kit</b>	<b>Item Code SA27313</b> Bushing kit for SA27329
	<b>Kit balljoints</b>	<b>Item Code SA27276</b> Rod end kit (1/2-20 thread) for tie bar kit SA27252
	<b>Hardware mounting kit</b>	<b>Item Code 064002</b> Hardware kit Compac-T helm (Ref. A) (no bracket, no hood)



Full  
Speed  
Ahead!



*SeaStar*<sup>®</sup>

Hydraulic Steering System SeaStar  
for Outboards up to 258kW (350HP)



*BayStar*<sup>™</sup>

Hydraulic Steering System BayStar  
for Outboards up to 110kW (150HP)



**allpa**  
marine equipment

# BayStar Outboard Steering Application Guide

## SINGLE ENGINE ONLY - APPLICATION GUIDE BAYSTAR FRONT MOUNT CYLINDERS

ENGINE MANUFACTURER	YEAR	MODEL	CYLINDER	NOTES
Honda	1992 TO DATE	30-50HP	HC4645	
	1996 TO DATE	75-90HP	HC4645	
	2015 TO DATE	30-50HP	HC4645	
	1998 TO 2010	BF100	HC4647	
	2003 TO DATE	115-130HP	HC4645	
	2010 TO DATE	115HP	HC4645	
Johnson / Evinrude	1977 TO 1990	65-150HP	HC4648	
	1991 TO DATE	40-150HP	HC4645	See Note 2
	1997 TO DATE	115HP FICHT	HC4658	See Note 4
	1997 TO DATE	75-150HP FICHT	HC4645	See Note 5
	1998 TO DATE	40-140HP 4-STROKE	HC4658	See Note 1, 2, 4
Mercury/Mariner	1984 TO DATE	75-150HP	HC4645	See Note 5
	1998 TO DATE	40-60HP	HC4645	See Note 1
Nissan	1990 TO DATE	120-140HP	HC4645	
Tohatsu	1990 TO DATE	40-140HP	HC4645	See Note 2
	2014 TO DATE	BFT60-BFT150	HC4645	
Selva	1996 TO DATE	35-100HP	HC4648	
	2003 TO DATE	25-60HP 4-STROKE	HC4648	See Note 1
	2002 TO DATE	100HP 4-STROKE	HC4645	
	2002 TO DATE	115HP 4-STROKE	HC4645	
	2002 TO DATE	150HP HPDI	HC4645	
	2010 TO DATE	100-150HP 4-STROKE	HC4645	
Suzuki	1986 TO DATE	150HP	HC4645	See Note 5
	1996 ONLY	115-140HP	N/A	
	1987 TO 2002	115-140HP	HC4645	See Note 1, NOT 1996
	1990 TO 2000	90-100HP	HC4645	
	1998 TO DATE	40-70HP 4-STROKE	HC4645	See Note 1, 2
	2001 TO DATE	90-140HP 4-STROKE	HC4658	See Note 1, 4
	Yamaha	1998 TO DATE	40-50HP 2-STROKE	HC4645
1998 TO DATE		60HP 2-STROKE	HC4645	See Note 3
1986 TODATE		70-90HP 2-STROKE	HC4645	See Note 1
1997 TO DATE		80-150HP 4-STROKE	HC4645	See Note 5
2000 TO DATE		25-70HP 4-STROKE	HC4648	See Note 1, 2
2011 TO 2013		F115A incl. SH0 90 & 115HP	HC4658	
2014 TO DATE		F80D-F100F-F115B-F130A	HC4645	
		15pk	HC4645-3	

### BayStar Outboard Compact Cylinder Application Guide (Cylinders HC4645 /47 /48 /58)



#### Volume 118.6cc - Stroke 203mm

#### COMMENTS

1. Requires spacer kit **H05090**
2. Engine clamp brackets must be cut or ground, and the engine through bolted onto the transom, or interference will occur, restricting engine trim and tilt.
3. Steering hook Yamaha Part # 63D-48511-00-4D must be installed
4. Cylinder HC4645 may be used in these applications. The pivot plate will need to be flipped before installation. Instructions provided with Owner's Manual.
5. High performance 150HP engines should use SeaStar.

HC4645 compact cylinder is included in the BayStar Steering kits. If your engine requires the use of a cylinder other than HC4645 or HC4658 then please refer to the figure below for additional replacement pivot plate. The specific cylinders with different pivot plates are of course also available!



**HA4640**

Comes with cylinder HC4645



**HA4642**

Comes with cylinder HC4648

**HA4641**

Comes with cylinder HC4647



**HA4643**

Comes with cylinder HC4658

Revision Date: August, 2018. For up-to-date engine applications go to: [www.seastarsolutions.com](http://www.seastarsolutions.com)

# BayStar™

For outboards up to 150hp total, BayStar provides hydraulic steering performance. Fits virtually any outboard engine from 1990 to date, 40-150hp. TM Steering lock valves integrated in helm. Patented No Feedback. 5,25 turns.

Kits come with a convenient 2 x 20' hydraulic tubing which are easily made to measure.

Baystar Kit <b>STANDARD:</b>	Item Code <b>HK4200A-3</b>
Pump 1,4/22,9cc	Item Code HH4314-3
Cylinder	Item Code HC4645
Hose kit 20'	Item Code HT4420
Hydraulic Oil (2x)	Item Code HA5430
Oil fill kit	Item Code HA5438

Baystar Kit <b>LUXE:</b>	Item Code <b>HK4222A-3</b>
Pump 1,4/22,9cc	Item Code HH4314-3
Cylinder	Item Code HC4645
Hose kit Luxe 20'	Item Code H05799
Hydraulic Oil (2x)	Item Code HA5430
Oil fill kit	Item Code HA5438

Baystar Kit <b>LUXE TILT:</b>	Item Code <b>HK4233A-3</b>
Pump-Tilt 1,4/22,9cc	Item Code HH4315-3
Cylinder	Item Code HC4645
Hose kit Luxe 20'	Item Code H05799
Hydraulic Oil (2x)	Item Code HA5430
Oil fill kit	Item Code HA5438

**Item Code HC4645** BayStar Compact balanced cylinder  
Designed to fit even the narrowest of splashwells

**Item Code HH4314-3** New BayStar 1.4 Front Mount aluminum helm (22.94cc) with ± 4.5 turns

**Item Code HH4315-3** New BayStar 1.4 Tilt helm

**Item Code HA5476** Round Bezel Kit. Reduces helm protrusion by 3.75" (95mm)

#### Spare kits:

**Item Code HF4202** Fitting kit for BayStar cylinder, NPT

**Item Code HF4203** Fitting kit for BayStar cylinder, ORB-4

**Item Code HP6104** Fitting kit 20° for BayStar helm (HC4314)

**Item Code HF6011** Fitting kit 45° for ORB-BayStar helm (HH4314-3)

**Item Code HS5147** Sealkit old model BayStar helm (HH4016)

**Item Code HP4600** Sealkit (with glands) BayStar cilinder, NPT

**Item Code HP4601** Sealkit (with glands) BayStar cilinder, ORB-4

**Item Code HP6032** Service kit for **new** BayStar (HH4314-3/HH4315-3) & **new** SeaStar helms

This kit consists of: seal, shaft nut, key & top plate with screws



Item Code **HK4200A-3**  
Baystar Kit **STANDARD**

**BayStar  
hydraulisch  
stuursysteem  
voor  
buitenboord-  
motoren  
tot 110kW  
(150pk)**

Item Code **HK4222A-3**  
Baystar Kit **LUXE**

Item Code **HK4233A-3**  
Baystar Kit **LUXE TILT**



Application Guide SeaStar Front Mount Cylinder

SINGLE + DUAL ENGINES

If your engine's Horsepower rating is 300+, please refer to our **300HP + Outboard Installation Recommendations** prior to selecting a cylinder from this application guide to ensure that you are selecting the correct cylinder for your engine/boat.

ENGINE MANUFACTURER	YEAR	MODEL	CYLINDER	TIE BAR KITS		NOTES
				Twin Engine Single Cylinder	Twin Engine Dual Cylinder	
Honda	1996 TO DATE	75-90HP	HC5345-3	H06001	H06002	See Note 3
	1998 TO 2009	115-130HP	HC5347-3	H05063	H05064	See Note 5
	1998 TO DATE	30-50HP	HC5345-3	H06001	H06002	See Note 2
	2001 TO DATE	BF150HP 4-STROKE	HC5445-3	H06001	H06002	See Note 8
	2001 TO DATE	BF200-250HP	HC5445-3	H06001	H06002	
	2003 TO DATE	BF135HP	HC5345-3	H06003	H06002	
	2010 TO DATE	115HP	HC5345-3	H06003	H06002	
	2015 TO DATE	BF100HP	HC5345-3	H06003	H06002	See Note 7
Johnson / Evinrude	1977 TO 1990	65-300HP	HC5348-3	H06003	H06002	
	1988 TO 1997	250-300HP V8	HC5342	H05001A	H05030	See Note 5 discount.
	1991 TO DATE	40-300HP	HC5345-3	H06003	H06002	Incl. ETech
	1996 TO DATE	75-250HP FICHT	HC5345-3	H06003	H06002	
	1998 TO DATE	40-140HP 4-STROKE	HC5358-3	H06003	H06002	See Note 2
	2000 TO DATE	115HP FICHT	HC5358-3	H06003	H06002	See Note 2
	2002 TO DATE	200-225HP 4-STROKE	HC5345-3	H06003	H06002	
	2005 TO DATE	E250 DPX Vindicator	HC5348-3	H06003	H06002	
	2007 TO DATE	3.3L V6 200-250HP	HC5345-3	H06003	H06002	Incl. H.O. Models
Mercury	1984 TO 1994	2.4/2.5HP EFI	HC5345-3	H06001	H06002	See Note 4
	1989 TO DATE	75-300HP	HC5345-3	H06001	H06002	See Note 3
	1996 TO DATE	75-200HP 2 & 4-STROKE	HC5345-3	H06001	H06002	
	1998 TO DATE	30-60HP	HC5345-3	H06001	H06002	See Note 2
	2002 TO 2003	225HP 4-STROKE	HC5358-3	H06001	H06002	See Note 1
	2004 TO DATE	150-200HP VERADO	HC5345-3	H06001	H06002	
	2003 TO DATE	150-200HP XS		<i>Must Use Tournament Cylinders. Contact tech. support for details</i>		
	2003 TO DATE	250-300HP XS		<i>Must Use Tournament Cylinders. Refer to page 42-43</i>		
Nissan	1990 TO DATE	90-140HP	HC5345-3	H06001	H06002	
Selva	2002 TO DATE	100HP 4-STROKE	HC5345-3	H06001	H06002	
	2002 TO DATE	115HP 4-STROKE	HC5345-3	H06001	H06002	
	2002 TO DATE	150HP HPDI	HC5345-3	H06001	H06002	See Note 1
	2007 TO DATE	150HP 4-STROKE	HC5345-3	H06001	H06002	See Note 1
	2010 TO DATE	100-150HP 4-STROKE	HC5345-3	H06001	H06002	See Note 1
Suzuki	1986 TO DATE	100HP	HC5345-3	H06003	H06002	
	1986 TO 2002	115-140HP	HC5345-3	H06001	H06002	
	1986 TO DATE	150-300HP 2 & 4-STROKE	HC5345-3	H06003	H06002	NOT 1996
	1996 ALLEEN	115-140HP	HC5348-3	H06001	H06002	
	1998 TO DATE	40-140HP 4-STROKE	HC5358-3	H06003	H06002	See Note 2
	2003 TO DATE	90HP 4-STROKE	HC5358-3	H06003	H06002	See Note 2
	2013 TO DATE	DF150-DF175HP	HC5345-3	H06001	H06002	
	2017 TO DATE	DF350 4.4L V6		<i>Must Use Tournament Cylinders. Refer to page 42-43</i>		
Yamaha	1990 TO 2007	40-90HP 2-STROKE	HC5345-3	H06003	H06002	
	1986 TO DATE	100-250HP 2-STROKE	HC5345-3	H06001	H06002	
	2000 TO DATE	150-300HP HPDI	HC5345-3	H06001	H06002	
	2001 TO 2003	80-250HP 4-STROKE	HC5358-3	H06001	H06002	See Note 1
	2003 TO DATE	F200-F250 3.3L	HC5358-3	H06001	H06002	
	2003 TO DATE	25-70HP 4-STROKE	HC5348-3	H06003	H06002	See Note 2
	2007 TO DATE	200-300HP 4.2L V6 4-STROKE	HC5345-3		H06001 H06002	
	2007 TO DATE	F300-F350HP 5.3V8		<i>Must Use Tournament Cylinders. Refer to page 42-43</i>		
	2011 TO 2013	F115A	HC5358-3	H06003	H06002	
	2014 TO DATE	F80D-F100F-F115B-F130A	HC5345-3	H06001	H06002	



H05090



H06001

Notes

1. HC5345-3 is optional for SINGLE ENGINE ONLY applications. DO NOT use for TWIN ENGINE as operational interference may occur.
2. Requires Kit H05090.
3. Minimum Engine Center = 27"
4. May Require Extensive Cowling Modifications.
5. H05030 and H05064 comes without Tie Bar.
6. One cylinder per engine. Must use Mercury supplied tiller bolt for installation.
7. Customer supplied SS washer must be installed under rod end.
8. Slight interference may occur with H06001 tie-bar, contact SeaStar for technical support.

The above engine applications are current through the revision date shown.  
**Revision Date: July, 2018.** For up-to-date engine applications go to:  
[www.seastarsolutions.com](http://www.seastarsolutions.com)





By DOMETIC

**Item Code 074300 (5 turns)**

Complete system for 1 engine and 1 helm.

**Components:**

SeaStar 1.7 helm	HH5271-3
Front mount cylinder	HC5345-3 (*)
Hose kit 16'	H05116
2 litre hydraulic oil	HA5430

Complete sets also available for dual engines with single or dual cylinders and for single or dual helms.  
Also available with SeaStar 2.0 or 2.4 helm

(\*) Item Code HC5345-3 is a very common cylinder. However, allpa supplies also specific cylinders if required (see table on page 38). The price for the complete kit remains the same. Kit price will be adjusted if longer or shorter hose kits are required (16' is standard).

For tie bars see the application table on page 38 and for accessories see page 60-63.



**Complete System  
SeaStar 350hp**

**Standard**



**Item Code 074305 (5 turns)**

Complete system for 1 engine and 1 helm.

**Components:**

SeaStar 1.7 TILT-helm	HH6191-3
Front mount cylinder	HC5345-3 (*)
Hose kit 16'	H05116
2 litre hydraulic oil	HA5430

Complete sets also available for dual engines with single or dual cylinders and for single or dual helms.

(\*) Item Code HC5345-3 is a very common cylinder. However, allpa supplies also specific cylinders if required (see table on page 38). The price for the complete kit remains the same. Kit price will be adjusted if longer or shorter hose kits are required (16' is standard).

For tie bars see the application table on page 38 and for accessories see page 60-63.



**Complete System  
SeaStar 350hp  
"TILT"**

**Tilt**



**Pro**

**Complete System  
Seastar-Pro  
350hp**

**Item Code 074325**

Complete system for 1 engine and 1 helm.

- Components:**
- SeaStar 2.0 Pro Helm      Item Code HH5770-3 33cc/103bar)
  - Front mount cylinder      Item Code HC5345-3
  - Kevlar hose kit 16'      Item Code H05716
  - Hydraulic oil 2l      Item Code HA5430

Complete sets also available for dual engines with single or dual cylinders and for single or dual helms.

The indication "Pro" concerns the helm. A Pro-helm has special valves with very low play and is **meant for bass boats (flat bottom) with high powered single outboards reaching speeds of over 100km/h.** For these nervous type of boats, the steering must be ultra precise. The working pressure is 103bar (instead of the normal 70bar) hence the Kevlar hoses. For "normal" boating less suitable.



**SeaStar Front  
mount cylinder**

**Item Code HC5345-3** Front mount cylinder

Easy mounting, fits virtually every outboard engine without adapter (See application table on p. 38).  
Volume: 136,6cc. Stroke: 203mm.

**Number of turns:**

- no.1 cylinder, with helm SEASTAR-1.7: 4,50
- no.1 cylinder, with helm SEASTAR-2.0: 4,00
- no.1 cylinder, with helm SEASTAR-2.4: 3,25

**Item Code HC5347-3** Frontmount cylinder Honda 115-130hp

**Item Code HC5348-3** Frontmount cylinder Johnson/ Evinrude 1977-1990

**Item Code HC5358-3** Front mount cylinder Yamaha 4-stroke>2000, 200-225hp, 350hp (SeaStar Pro)



HO 6001

**Tie Bar Kits**

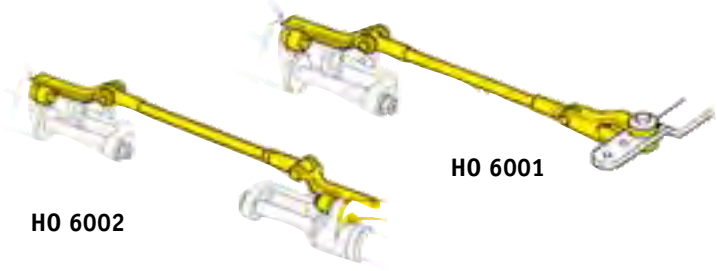

HO 6002

HO 6001



**Power Purge**

**Item Code HA5445-2**

This self contained automatic filling- and purging system takes away all the pain and frustration out of purging a SeaStar or BayStar hydraulic steering system.

# We have it all



**allpa**  
marine equipment



SeaStar®



**300hp+**

**SeaStar  
New Tournament  
Cylinders**

**for aggressive  
use**

**Suitable for all engine makes of 200hp+**

**Extreme heavy duty cylinders and tie bars designed for primarily high performance multiple engine applications. Also available for single engine applications.**

**Features:**

- Suitable for use with all SeaStar Helms & SeaStar Power Assist
- Heavy duty universal cylinder
- Bolt on stainless steel tie bar plates, also reversible (patent pending)
- Robust design with heavy duty support brackets, barrel, shaft & seals
- Superior corrosion resistance
- New pivot plate design provides smooth articulation and a sealed joint (patent pending)
- Heavy duty adjustable tie bar (patent pending)
- Equipped with stainless steel adjustable o-ring sealed elbow fittings which can be easily orientated in any direction.
- Volume: 136,6cc
- Stroke: 203mm.



**Item Code HA5445-2**

Self contained automatic filling- and purging system for hydraulic steering systems.



**APPLICATION GUIDE: TOURNAMENT SERIES CYLINDERS & TIE BARS  
ALL ENGINE MAKES 200HP+**

Tournament Cylinder Configuration	Cylinder	Qty	Hardware Kit	Qty	Tiebar	Tiebar	Tiebar	Qty	Notes
	Item Code		Item Code		Engine Center Distance (inch)	Engine Center Distance (inch)	Item Code		
Single Engine - Single Cylinder	HC6845	1	HA6801	1	N/A	N/A	N/A		
Twin Engine - Single Cylinder (Starboard)	HC6845	1	HA6802	1	26.6" - 29.3"	676 - 744mm	H06821	1	1,3,4,5
					29.4" - 34.2"	747 - 869mm	H06822	1	1,3,4,5
					34.3" - 43.0"	871 - 1092mm	H06823	1	1,3,4,5
Twin Engine - Dual Cylinder	HC6845	2	HA6804	1	25.0" - 26.5"	635 - 673mm	H06820	1	1,3,4,5
					26.6" - 29.3"	676 - 744mm	H06821	1	1,3,4,5
					29.4" - 34.2"	747 - 869mm	H06822	1	1,3,4,5
					34.3" - 43.0"	871 - 1092mm	H06823	1	1,3,4,5
Triple Engine Dual Cylinder	HC6845	2	HA6806	1	29.4" - 34.2"	747 - 869mm	H06822	2	1,2,3,4,5,6
					34.3" - 43.0"	871 - 1092mm	H06823	2	1,2,3,4,5,6

**Notes:**

1. Installation may vary according to the following factors: engine mounting height, transom thickness, use of transom savers, tiller bolt location, engine tilt range and engine size.
2. For center engine drops greater than 3 inches (76mm), please consult SeaStar
3. Tie bar length may vary depending on toe in/ toe out setup. To allow for toe, add or subtract from your nominal engine center to center distance.
4. Based on recommended engine manufacturer minimum center to center distances. Deviating from these recommendations may require these recommendations may require stroke limiting cylinders and/or engine tilt limiting, please consult SeaStar Technical Service.
5. Cylinder's must be plumbed in parallel only, no series connections. Only exception is if cylinders are utilizing liquid tie bar.
6. Maximum drop: <3 inches (76mm). Contact SeaStar Technical Support for center engine drops greater than 3 inches.

Fitting / service kits	Item Code
ORB Elbow Fitting Service Kit	HF6004
ORB Tee Fitting Kit	HF6005
Gland Service Kit	HP6160
Support Rod Service Kit	HP6161
Support Bracket Service Kit	HP6162

Also available for 4 engines with 2 cylinders and 5 engines (plus). Please ask for an offer.

SeaStar

## SeaStar Power Assist - SPA



## SeaStar Power Assist - SPA with Autopilot



## SeaStar Stand Alone Autopilot



# SeaStar Power Assist

### General info:

SeaStar Power Assist – SPA - hydraulic steering dramatically reduces steering loads in heavy/high torque SeaStar hydraulic steering applications – delivering exceptional performance and unparalleled levels of safety and comfort even in the most extreme conditions.

Suitable for most boat types and powered from the boats battery (12V or 24V) SeaStar Power Assist steering uses an electronically controlled hydraulic pump to provide “Power” for your SeaStar hydraulic steering system, it is installed in between the helm pump and the cylinder.

The system virtually eliminates all steering loads even in the most extreme applications making the boat more comfortable to steer allowing the boat to be driven safely and easily by the whole

family...and by people of all ages. The SeaStar Power Assist unit can be installed on both new SeaStar steering installations (helms 1.4, 1.7, 2.0 & 2.4), or as an easy retro-fit with single or multiple steering stations and/or autopilots.

Should the power to the Power Assist unit fail for any reason, the steering system automatically returns to manual but heavier operation without any changes to the number of turns lock

to lock. Can now be connected directly to the switch board or distribution block. Suitable for both horizontal and vertical mounting without the need of an extra bracket. ABYC, CE, NMMA, ISO 10592 Approved.

### SPA-series:

- Now one SPA for both 12V and 24V  
For both standard and PRO-execution
- Standard SPA now also available with integral autopilot
- Stand alone autopilots also available:  
Autopilot pump type-1: 983cc/min. (no-load)  
Autopilot pump type-2: 1.638cc/min. (no-load)
- Cylinder capacity type-1: 73-205cc
- Cylinder capacity type-2: 205-344cc

**Item Code PA1200-2** SeaStar Power Assist, Standard, 12/24V, with 15' cable

**Item Code PA1315-2** SeaStar Power Assist, PRO, 12/24V, with 15' cable

**Item Code PA6010** Standard SPA with Autopilot pump type 1, 12V

**Item Code PA6020** Standard SPA with Autopilot pump type 2, 12V

**Item Code PA7010** Standard SPA with Autopilot pump type 1, 24V

**Item Code PA7020** Standard SPA with Autopilot pump type 2, 24V

**Item Code AP1219** Stand alone Autopilot type 1, 12V

**Item Code AP1233** Stand alone Autopilot type 2, 12V

**Item Code AP2419** Stand alone Autopilot type 1, 24V

**Item Code AP2433** Stand alone Autopilot type 2, 24V

**Item Code AR4502** Smart stick for outboard cylinder for Furuno and most other autopilots. Output 0,5v – 4,5V

**Item Code AR4502RM** Smart stick for outboard cylinder for Ray Marine. Output 2.2V – 2.8V

**Item Code AR4502SI** Smart stick for outboard cylinder for Simrad. Output 2.8 kHz – 4.0 kHz

**Item Code HF6010** ORB-Fitting kit for SeaStar Autopilot existing steering (inboard)

**Item Code HF6007** ORB-Fitting kit for SeaStar Autopilot existing steering (outboard)

**Item Code HA1205** Retro Fit kit for mounting autopilot to SeaStar Power Assist - SPA

**Item Code HA1206** Extra heavy “Maxi Fuse” 40A when SPA is direct Connected to the battery

**Item Code HA1201** Dual Ignition Control Kit designed to connect the SPA unit's ignition wire to two engines allowing one engine to be turned off and retain power assist control.



**Complete set for single engine and single helm**

Item Code 074340

**Components:**

- |                      |                            |
|----------------------|----------------------------|
| Power assist SPA     | Item Code PA1200-2 SPA     |
| Front Mount Cylinder | Item Code HC5345-3         |
| Seastar 1.7 Helm     | Item Code HH5271-3 helm    |
| Hose Kit 4' & 14'    | Item Codes H05104 & H05114 |
| Nylon Tube 5 m       | Item Code HT51015          |
| Hydraulic Oil 3l     | Item code HA5430           |

Hydraulic  
Steering kit  
350hp  
complete with  
SeaStar Power  
Assist - SPA !



CE

SeaStar®

# OPTIMUS EPS

BY SEASTAR

## Introduction

Optimus EPS, Electronic Power Assist. Boat that steers like a sports car. Driver comfort, control and performance as speed varies. Plug and Play autopilot compatibility without the need of an autopilot pump and rudder feedback unit. Can be retrofitted to existing mechanical and electronic controlled engines. You do not have to buy new engines. No tie-bars (twin configuration). No liquid tie-bar (CAT). On demand pumps which extend battery life. 2nd station is easy in no additional hose runs.

## Features and Benefits

- No hydraulic oil at the helm
- Speed sensitive helm turns, effort and response
- Adjustable helm turns
- Plug and Play Autopilot compatibility, no extra pump needed or rudder feedback unit needed
- No tie-bars required
- For mechanical and electronic controlled engines
- NMEA 2000 certified
- Compatible with Garmin GHP20, Raymarine EV2 and SimradSG05 Autopilots

## Outboard:

### Complete set for 1 Outboard engine

- Optimus EPS Core Pack (Hydraulic Pump, Control Module, CANtrak Display, Oil)
- SmartCylinder Outboard
- Electronic Helm Pump

### Complete set for 2 Outboard engines

- Optimus EPS Core Pack (2x Hydraulic Pump, Control Module, CANtrak Display, Oil)
- 2x SmartCylinder Outboard
- Electronic Helm Pump

## Inboard:

### Complete set for 1 Inboard engine

- Optimus EPS Core Pack (Hydraulic Pump, Control Module, CANtrak Display, Oil)
- SmartCylinder Inboard
- Electronic Helm Pump

### Complete set for 2 Inboard engines

- Optimus EPS Core Pack (2x Hydraulic Pump, Control Module, CANtrak Display, Oil)
- 2x SmartCylinder Inboard
- Electronic Helm Pump

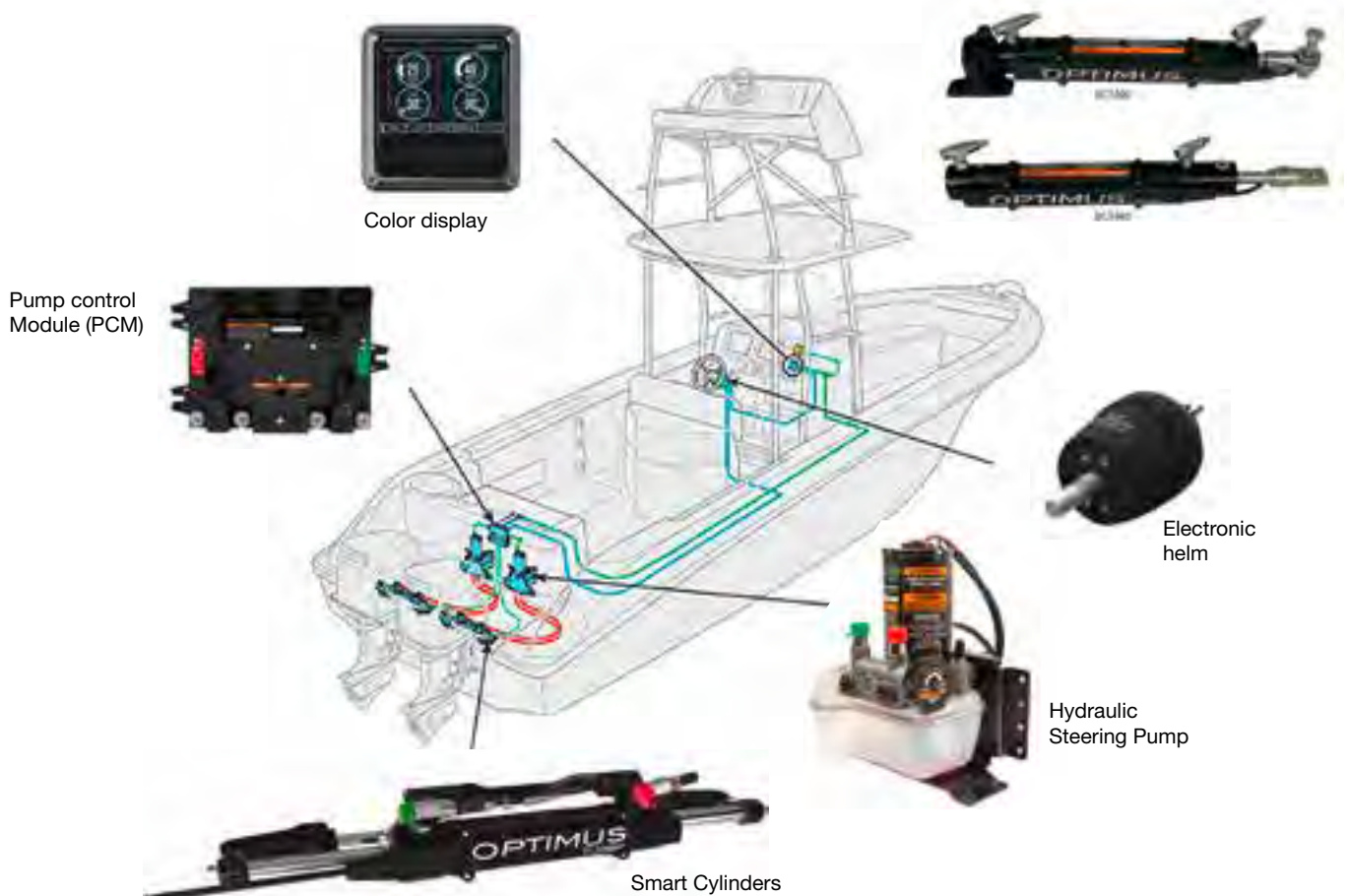



**Optimus EPS Electronic Steering System for Outboard Engines, with Front Mount Cylinder**

**1 Engine – 1 Station**

Item Code	Set Optimus EPS Outboard for 1 Engine & 1 Station
SETEPS01	This standard set consists of:
EPK1100C	<b>Optimus Single EPS Core Pack, including:</b>
EP1500	Hydraulic Pump Unit
EM1200S	PCM processor
ED1800	Cantrak color display
HA5482	EPS-Oil (2x)
	and all necessary CANbus fittings
	<b>Furthermore in this set:</b>
EC5310	Electronic steering cylinder
EH1512	Electronic helm 12/24V
H05708	SeaStar Pro hose kit 8'
CM10012	CANbus-cable 12' (2x)
CM10060	CANbus T-Fitting (Fly-by-Wire)
CM20503	Interface-cable (NMEA 2000)
	<b>Some options:</b>
EH1532	Built-on Sport Plus Tilt-helm
EH1552	Built-on Classic Tilt-helm
EH1572	Built-in helm
	Hose kits are available in several lengths optionally with bulkhead fitting (also in Stainless Steel)
	CANbus-cables are available in several lengths



**allpa®** The European Marine Distributor

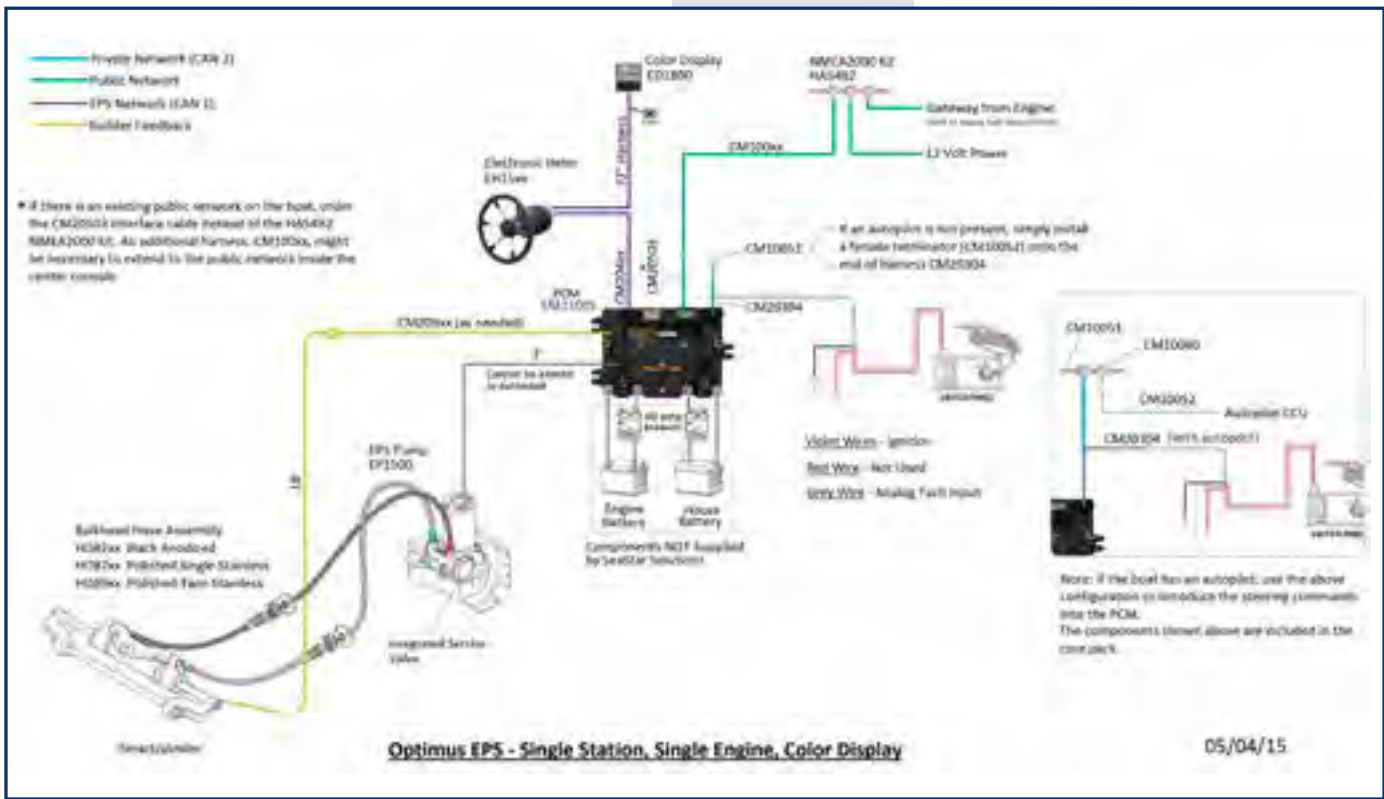

Compose your own complete Optimus EPS system on: [www.optimusbom.com](http://www.optimusbom.com)  
 Send the BOM-list (Bill Of Material) in PDF-format to [info@allpa.nl](mailto:info@allpa.nl) for additional information



EC5310



EP1500



EM1200

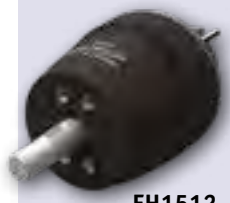

EH1512



ED1700

**Optimus EPS Electronic Steering System for Outboard Engines, with Front Mount Cylinder**

**2 Engines – 1 Station**

Item Code	Set Optimus EPS Outboard for 2 Engines & 1 Station
SETEPS02	This standard set consists of:
EPK1200C	<b>Optimus Dual EPS Core Pack, including:</b>
EP1500	Hydraulic Pump Unit (2x)
EM1200	PCM processor
ED1700	Cantrak color display
HA5482	EPS-Oil (4x)
	and all necessary CANbus fittings
	<b>Furthermore in this set:</b>
EC5310	Electronic steering cylinder (2x)
EH1512	Electronic helm 12/24V
H05708	SeaStar Pro hose kit 8'
CM10012	CANbus-cable 12' (2x)
CM10060	CANbus T-Fitting (Fly-by-Wire)
CM20503	Interface-cable (NMEA 2000)
CM20412	CANbus-cable 12'
	<b>Some options:</b>
EH1532	Built-on Sport Plus Tilt-helm
EH1552	Built-on Classic Tilt-helm
EH1572	Built-in helm
	Hose kits are available in several lengths optionally with bulkhead fitting (also in Stainless Steel)
	CANbus-cables are available in several lengths

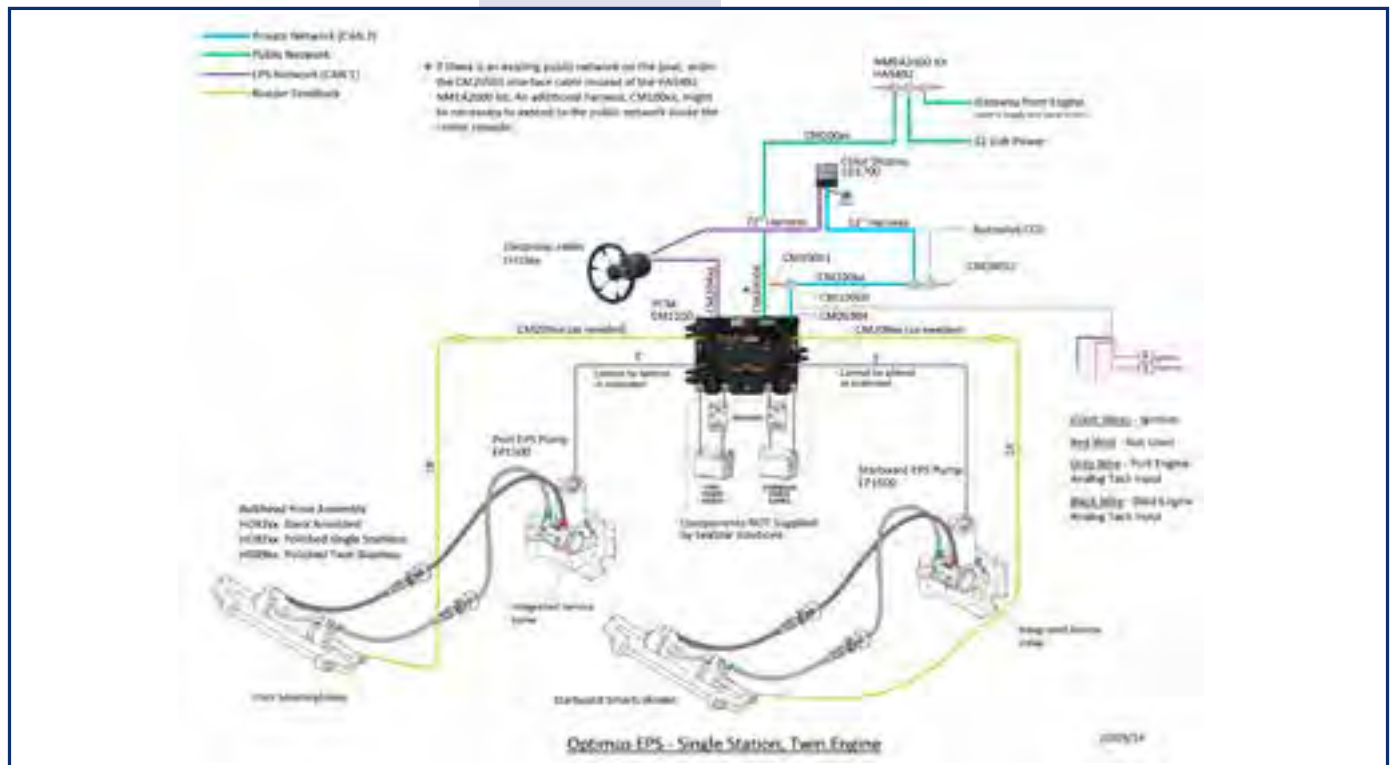

Compose your own complete Optimus EPS system on: [www.optimusbom.com](http://www.optimusbom.com)  
 Send the BOM-list (Bill Of Material) in PDF-format to [info@allpa.nl](mailto:info@allpa.nl) for additional information

**Optimus EPS Electronic Steering System for Inboards and Sterndrives (boats of 18'-34')**

**1 Engine – 1 Station**

Item Code SETEPS06	Set Optimus EPS Steering System for Inboards, 1 Engine – 1 Station
<b>OR</b>	
Item Code SETEPS07	Set Optimus EPS Steering System for Sterndrives, 1 Engine – 1 Station
	These standard sets consist of:
EPSK1120	<b>Optimus Dual EPS Core Pack, including:</b>
EP1501	Hydraulic Pump Unit
EM1200S	PCM processor
ED1800	Cantrak color display
HA5482	EPS-Oil (2x)
	and all necessary CANbus fittings
	<b>Furthermore in this set:</b>
EC5380	Electronic steering cylinder Inboard <b>or:</b>
EC5360	Electronic steering cylinder Sterndrive
EH1512	Electronic helm 12/24V
H05708	SeaStar Pro hose kit 8'
CM10030	CANbus-cable 30'
CM20424	CANbus-cable 24'
	<b>Some options:</b>
EH1532	Built-on Sport Plus Tilt-helm
EH1552	Built-on Classic Tilt-helm
EH1572	Built-in helm
	Hose kits are available in several lengths optionally with bulkhead fittings (also in stainless steel)
	CANbus-cables are available in several lengths

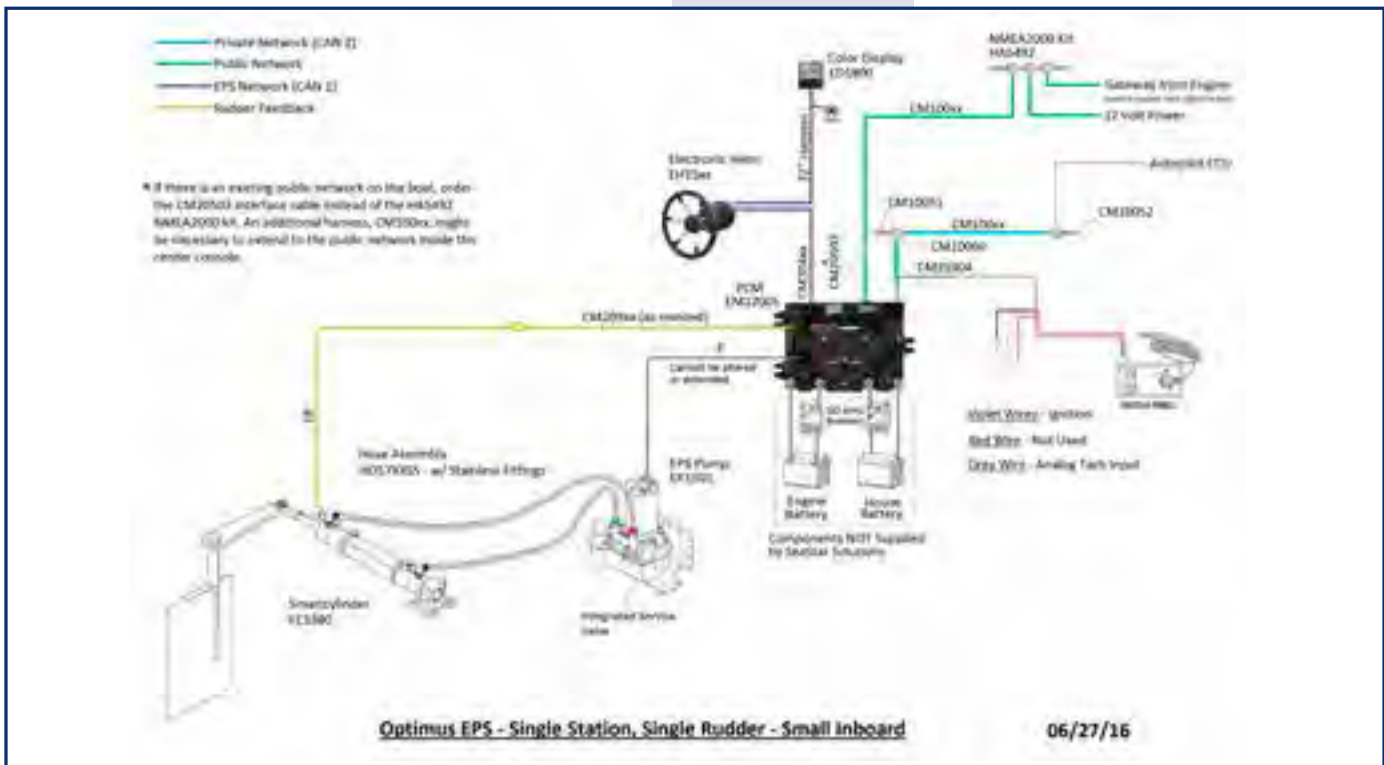

Compose your own complete Optimus EPS system on: [www.optimusbom.com](http://www.optimusbom.com)  
 Send the BOM-list (Bill Of Material) in PDF-format to [info@allpa.nl](mailto:info@allpa.nl) for additional information



2x EC5380 Inboard

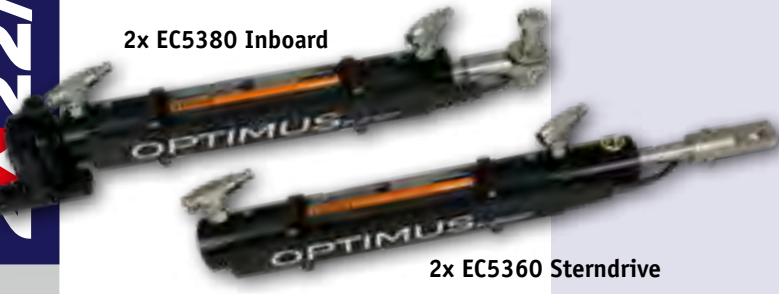

2x EC5360 Sterndrive

EP1501



ED1700

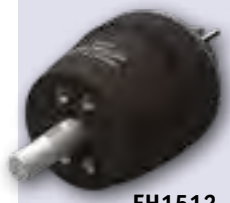

EH1512



EM1200

**Optimus EPS Electronic Steering System for Inboards and Sterndrives (boats of 18'-34')**

**2 Engines – 1 Station**

Item Code SETEPS11	Set Optimus EPS Steering System for Inboards, 2 Engines – 1 Station
<b>OR</b>	
Item Code SETEPS12	Set Optimus EPS Steering System for Sterndrives, 2 Engines – 1 Station
These standard sets consist of:	
EPSK1280	<b>Optimus Dual EPS Core Pack, including:</b>
EP1501	Hydraulic Pump Unit (2x)
EM1200	PCM processor
ED1700	Cantrak color display
HA5482	EPS-Oil (4x)
and all necessary CANbus fittings	
<b>Furthermore in this set:</b>	
EC5380	Electronic steering cylinder Inboard (2x) <b>or:</b>
EC5360	Electronic steering cylinder Sterndrive (2x)
EH1512	Electronic helm 12/24V
H05708	SeaStar Pro hose kit 8' (2x)
CM10030	CANbus-cable 30'
CM20430	CANbus-cable 30'
<b>Some options:</b>	
EH1532	Built-on Sport Plus Tilt-helm
EH1552	Built-on Classic Tilt-helm
EH1572	Built-in helm
Hose kits are available in several lengths optionally with bulkhead fittings (also in stainless steel)	
CANbus-cables are available in several lengths	

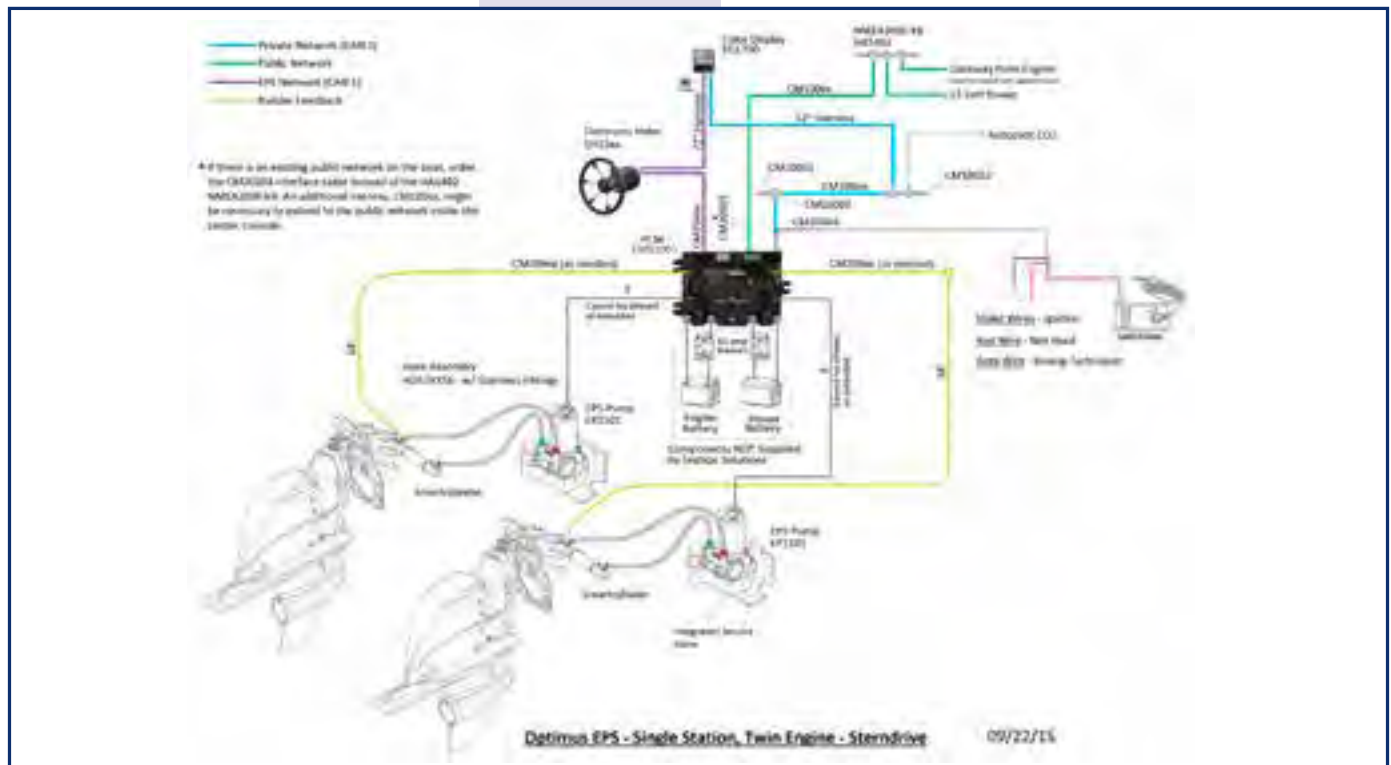

Compose your own complete Optimus EPS system on: [www.optimusbom.com](http://www.optimusbom.com)  
 Send the BOM-list (Bill Of Material) in PDF-format to [info@allpa.nl](mailto:info@allpa.nl) for additional information

**Complete kit for single engine and single helm**

**Item Code 074310**

**Components:**

- SeaStar 1.7 Helm (HH5271-3)
- Side Mount Cylinder (HC5370-3)
- Hose Kit 14' (H05114)
- Hydraulic Oil (2x) (HA5430)
- All Fittings included



**Complete Kit for dual engines and single helm**

**Item Code 074312**

**Components:**

- SeaStar 2.4 Helm (HH5272-3)
- 2x Side Mount Cylinder (HC5370-3)
- Hose Kit 10' (H05110)
- Hose Kit 6' (H05106)
- Hose Kit 2' (H05102)
- Fitting Kit (HF5530)
- Hydraulic Oil (3x) (HA5430)
- Tie Bar Kit (H05009)

**Application:**

- Single Cylinder, Single Engine: max. 220kW (300hp)
- Single Cylinder, Dual Engine: max. 440kW (600hp) with counter rotating propellers
- Dual Cylinder, Dual Engines: max. 440kW (600hp)
- Max. 120km/h

**Item Code HC5370 Cylinder.**

- Volume: 135-161cc, Stroke: 230mm.
- Number of Turns with 1.7 helm: 4.8/5.7 (no.1 cyl.)
- Also suitable for engines with original (factory) Power Assist.
- Not suitable for SeaStar PRO helms

Steering Wheels: see from page 66.

**Complete kit for single engine and single helm**

**Item Code 074320**

**Components:**

- SeaStar 1.7 Helm (HH5271-3)
- Splashwell Mount Cylinder (HC5380-3)
- Hose Kit 14' (H05114)
- Hydraulic Oil (2x) (HA5430)
- All Fittings included



**Application:**

- Single Cylinder, Single Engine: max. 220kW (300hp)
- Single Cylinder, Dual Engine: max. 440kW (600hp) with counter rotating propellers
- Max. 100 km/h

**Item Code HC5380-3 Cylinder**

- Volume: 152-181cc, Stroke: 229mm
- Number of Turns with 1.7 Helm: 5.5/6.5

Steering Wheels: see from page 66.



SeaStar

By DOMETIC

allpa® The European Marine Distributor

BayStar™



**BayStar Inboard Hydraulic Steering System SET**

**BayStar Inboard engines SET**

BayStar steering of the wellknown SeaStar quality. Designed for use on relatively low torque application, Including inland waterways boats and other typically low speed displacement vessels. Easy to install with simple "cut to length" tubing. Available as separate components or as a complete kit.

**BayStar Inboard Kit 30kgm Set**  
Item Code HK4401-3

**Components:**  
Item Code HH4314-3 BayStar 1.4 Helm 23cc  
Item Code HC4461-3 Inboard Cylinder 30kgm Volume 58cc, Stroke 153mm, Turns 2,53  
Item Code HT4420 Tubing Kit 20'  
Item Code HA5430 Hydraulic Oil (1x)  
All fittings included



HC4461-3



HC4461-3  
30kgm



HC4460-3



HC4460-3  
52kgm

**BayStar Inboard Kit 52kgm Set**  
Item Code HK4400-3

**Components:**  
Item Code HH4314-3 BayStar 1.4 Helm 23cc  
Item Code HC4460-3 Inboard Cylinder 52kgm Volume 105cc, Stroke 159mm, Turns 4,58  
Item Code HT4420 Tubing Kit 20'  
Item Code HA5430 Hydraulic Oil (1x)  
All fittings included

Hydraulic steering for transom mount rudders - 32kgm / 35°  
 Designed for use on boats (sloops) with round sterns.  
 BayStar/allpa steering of the transom mount SeaStar quality.  
 Easy to install with simple "cut to measure" tubing.  
 Available as separate components or as a complete kit.

**Item Code HK4450**

BayStar/allpa Steering Kit 32kgm

**Components:**

Item Code CE50/S allpa cylinder 32kgm

volume 88cc, stroke 200mm, turns 3,8

Item Code HH4314-3 BayStar helm 1.4 (23cc)

Item Code 057991 Tubing kit 2 x 6m

Item Code HA5430 Hydraulic oil 1l

All fittings included

Note: Cylinder separately comes without splashwell mounting kit (A230) and clevis (A322).

These are included in the kit!



BayStar/allpa Hydraulic Inboard Steering



**allpa hydraulic inboard steering for boats of 15-20 ft.**

Easy to install with hydraulic hoses which can be cut to measure. Available as a complete kit or in separate components.

**Item Code GE30**

allpa inboard steering kit 32kgm

**Components:**

Item Code CE30 allpa cylinder 32kgm/35°

volume 57cc, stroke 150mm, turns 3,4

Item Code GM0 allpa helm (17cc)

Item Code H05799 + 057915 = Tubing kit 2 x 6m

Item Code 057999 Hydraulic oil 1l incl. filling kit\*

(Item 057980)

All fittings included

\* The filling kit is a component of the complete steering kit and not of the oil!

Item Code 057036 Seal GM0 allpa helm

Item Code 057035 Seal CE30 allpa cylinder



allpa GE30 Hydraulic Inboard Steering

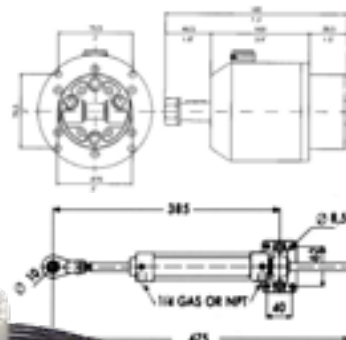

**allpa hydraulic inboard steering for boats of 18-30 ft.**

Easy to install with hydraulic hoses which can be cut to measure. Available as a complete kit or in separate components.

**Item Code GE50/T**

allpa inboard steering kit 50kgm

**Components:**

Item Code CE50/T allpa cylinder 50kgm/35°

volume 83cc, stroke 150mm, turns 3,0

Item Code GM2 allpa helm (27cc)

Item Code H05799 + 057915 = Tubing kit 2 x 6m

Item Code 057999 Hydraulic oil 1l incl. filling kit\*

(Item 057980)

All fittings included

\* The filling kit is a component of the complete steering kit and not of the oil!

Item Code 057036 Seal GM0 allpa helm

Item Code 057035 Seal CE30 allpa cylinder



allpa GE50/T Hydraulic Inboard Steering

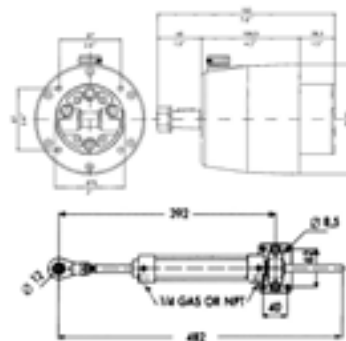

# SeaStar®



## FrontMount Helms

Item Code	Volume	Working-pressure	Max. Wheel Diameter Ø	
BayStar	HH4314-3	22,9cc	70bar	660mm
SeaStar 1,4	HH5269-3	22,9cc	70bar	660mm
SeaStar 1,7	HH5271-3	27,8cc	70bar	660mm
SeaStar 2,0	HH5273-3	33,0cc	70bar	660mm
SeaStar 2,0 Pro	HH5770-3	33,0cc	103bar	660mm
SeaStar 2,4	HH5272-3	39,3cc	70bar	660mm
SeaStar 2,4 Pro	HH5772-3	39,3cc	103bar	660mm
SeaStar 3,0	HH5285-3	49,2cc	70bar	660mm

## Rear Mount Helms

SeaStar 1,4	HH5260-3	23,0cc	70bar	660mm
SeaStar 1,7	HH5261-3	27,8cc	70bar	660mm
SeaStar 2,4	HH5262-3	39,3cc	70bar	660mm
SeaStar 3,0	HH5265-3	49,2cc	70bar	660mm

## Sport Tilt Helms

BayStar	HH4315-3	22,9cc	70bar	660mm
SeaStar 1,7	HH6191-3	27,8cc	70bar	508mm
SeaStar 1,7 Pro	HH6189-3	27,8cc	103bar	508mm
SeaStar 2,0	HH6145-3	33,0cc	70bar	508mm
SeaStar 2,0 Pro	HH6190-3	33,0cc	103bar	508mm
SeaStar 2,4	HH6192-3	39,3cc	70bar	508mm

## Traditional Tilt Helms

SeaStar 1,7	HH6541-3	27,8cc	70bar	508mm
SeaStar 2,0	HH6543-3	33,0cc	70bar	508mm
SeaStar 2,0 Pro	HH6574-3	33,0cc	103bar	508mm
SeaStar 2,4	HH6542-3	39,3cc	70bar	508mm

## Traditional Tilt Helms

Capilano 1250V	HH5250*	22,8-55,7cc	70bar	—
Capilano 1275V	HH5275*	44,2-88,4cc	70bar	—

# BayStar™

Item Code      Volume      Working-pressure      Max. Wheel Diameter Ø

BayStar	HH4314-3	22,9cc	70bar	660mm
SeaStar 1,4	HH5269-3	22,9cc	70bar	660mm
SeaStar 1,7	HH5271-3	27,8cc	70bar	660mm
SeaStar 2,0	HH5273-3	33,0cc	70bar	660mm
SeaStar 2,0 Pro	HH5770-3	33,0cc	103bar	660mm
SeaStar 2,4	HH5272-3	39,3cc	70bar	660mm
SeaStar 2,4 Pro	HH5772-3	39,3cc	103bar	660mm
SeaStar 3,0	HH5285-3	49,2cc	70bar	660mm

## Rear Mount Helms

SeaStar 1,4	HH5260-3	23,0cc	70bar	660mm
SeaStar 1,7	HH5261-3	27,8cc	70bar	660mm
SeaStar 2,4	HH5262-3	39,3cc	70bar	660mm
SeaStar 3,0	HH5265-3	49,2cc	70bar	660mm

## Sport Tilt Helms

BayStar	HH4315-3	22,9cc	70bar	660mm
SeaStar 1,7	HH6191-3	27,8cc	70bar	508mm
SeaStar 1,7 Pro	HH6189-3	27,8cc	103bar	508mm
SeaStar 2,0	HH6145-3	33,0cc	70bar	508mm
SeaStar 2,0 Pro	HH6190-3	33,0cc	103bar	508mm
SeaStar 2,4	HH6192-3	39,3cc	70bar	508mm

## Traditional Tilt Helms

SeaStar 1,7	HH6541-3	27,8cc	70bar	508mm
SeaStar 2,0	HH6543-3	33,0cc	70bar	508mm
SeaStar 2,0 Pro	HH6574-3	33,0cc	103bar	508mm
SeaStar 2,4	HH6542-3	39,3cc	70bar	508mm

## Traditional Tilt Helms

Capilano 1250V	HH5250*	22,8-55,7cc	70bar	—
Capilano 1275V	HH5275*	44,2-88,4cc	70bar	—

\* With adjustable volume

New SeaStar helms (and cylinders) with Item Code with suffix "-3" have "ORB" - fittings. These are sealed with an O-ring and may be oriented into any desired direction. SeaStar helms without suffix "-3" have 1/4" conical fittings.

Helm shaft details: 3/4" standard taper (1" per ft). Thread: 5/8" - 18 UNF. Key 3/16" (#606 Woodruff Key).

Port sizes -5 ORB (new SeaStar helms) or 1/4" NPT (old SeaStar helms and BayStar).

### Caution. For 1/4" NPT fittings the following applies:

- Fittings inserted in the rear of the helm should be installed until finger tight and then turned additional 1-1/2 to 2-1/2 turns depending on desired orientation of fitting. DO NOT exceed 156 in./lbs (17,6Nm)!
- Use a pipe sealant such as Loctite PST or equivalent on all fitting threads. DO NOT use "tape" sealers.
- Pro-Helms are not to be used with unbalanced cylinders: Lock-Up will occur.



Tilt helms have 5 positions



**SeaStar hydraulic inboard cylinders**  
**BayStar, SeaStar, Capilano**

Item Code	Type	Series	Body	Fittings	Stroke	Volume	Rudder Torque
HC4461-3	BA100-6ATM	BayStar	Aluminum	ORB	153mm	58cc	30kgm
HC4460-3	BA125-6.25ATM	BayStar	Aluminum	ORB	159mm	105cc	52kgm
HC5303-3	BA125-3ATM	SeaStar	Aluminum	ORB	76mm	45cc	---
HC5312-3	BA125-7ATM	SeaStar	Aluminum	ORB	178mm	118cc	58kgm
HC5313-3	BA135-7ATM	SeaStar	Aluminum	ORB	178mm	135cc	66kgm
HC5314-3	BA150-7ATM	SeaStar	Aluminum	ORB	178mm	168cc	82kgm
HC5318	BA150-7TM	SeaStar	Bronze	3/8"	178mm	168cc	82kgm
HC5319-3	BA175-7TM	SeaStar	Bronze	3/8"	178mm	225cc	110kgm
HC5351	BA200-7TM	Capilano	Bronze	1/2"	178mm	310cc	151kgm
HC5357	BA200-7TMC	Capilano	Bronze	1/2"	178mm	377cc	181kgm
HC5379	BA200-11TMC	Capilano	Bronze	5/8"	279mm	486cc	228kgm



Explanation type indication; e.g. BA150-7ATM

- "BA" => Balanced cylinder
- "150" => Internal diameter: 1-1/2" (38,1mm)
- "7" => Stroke is 7" (178mm)
- "A" => Aluminium body
- "TM" => Trunion mouted/rod end balljoint
- "TMC" => Trunion mounted/rod end clevis

*BayStar™*  
*SeaStar®*

**ATM-Cylinders**

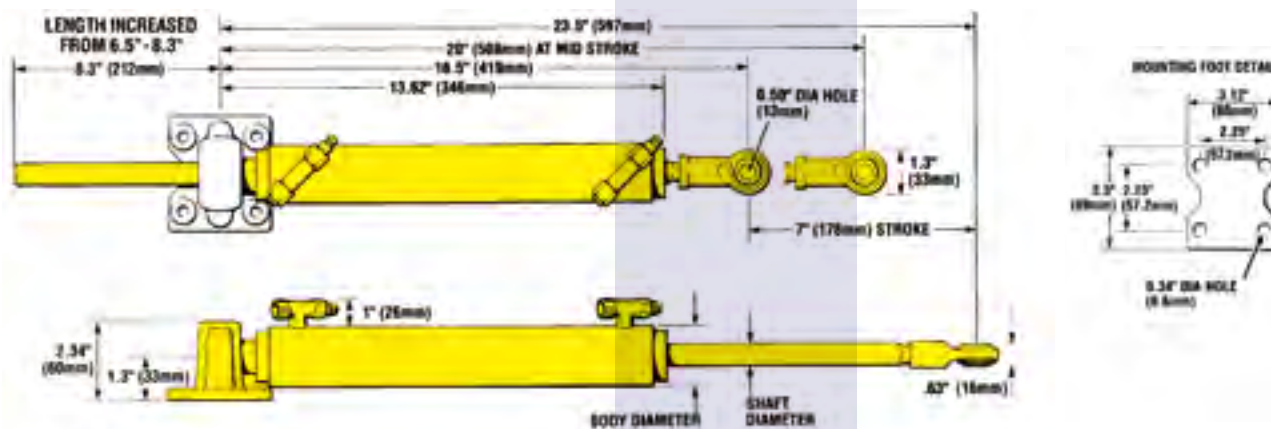

**Rudder angle with 7" cylinders (Stroke = 178mm):**

- Rudder arm, L=177mm: 2 x 30°
- Rudder arm, L=156mm: 2 x 35°
- Rudder arm, L=141mm: 2 x 40°
- Rudder arm, L=125mm: 2 x 45°

Helms & Cylinders come complete with fittings

Oil & Tubing see page 60

*Capilano™*

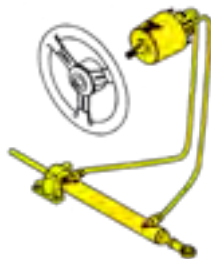

Inboard

### SeaStar Complete Inboard Steering System Set-1

Item Code 074058 „SYSTEM-1“ - 58kgm

**Number of turns: 4.0 lock-to-lock**

Components:

- Seastar 1,7 helm (HH5271-3)
- Alum. cylinder type BA125-7ATM (HC5312-3)
- 12m 3/8" nylon tubing (HT5101)
- fittings and 2l hydraulic oil (HA5430)

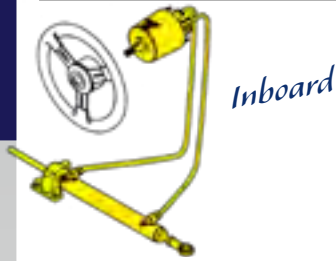

Inboard

### SeaStar Complete Inboard Steering System Set-2

Item Code 074066 „SYSTEM-2“ - 66kgm

**Number of turns: 5.0 lock-to-lock**

Components:

- Seastar 1,7 helm (HH5271-3)
- Alum. cylinder type BA135-7ATM (HC5313-3)
- 14m 3/8" nylon tubing (HT5101)
- fittings and 2l hydraulic oil (HA5430)

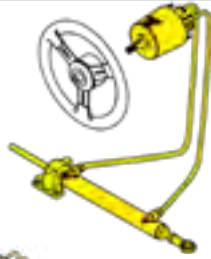

Inboard

### SeaStar Complete Inboard Steering System Set-3

Item Code 074082 „SYSTEM-3“ - 82kgm

**Number of turns: 6.0 lock-to-lock**

Components:

- Seastar 1,7 helm (HH5271-3)
- Alum. cylinder type BA150-7ATM (HC5314-3)
- 16m 3/8" nylon tubing (HT5101)
- fittings and 2l hydraulic oil (HA5430)

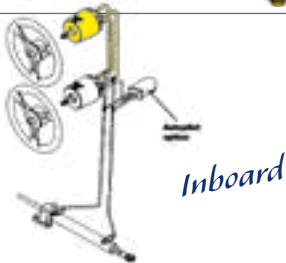

Inboard

### SeaStar Extension Kit Second Helm for: Set-1/2/3

Item Code 074058/2

**Kit for second helm position for Set 1, 2 and 3**

Components:

- Seastar 1,7 helm (HH5271-3)
- ORB-Fitting kit (HF6010)
- 12m 3/8" nylon tubing (HT5101)
- 1l hydraulic oil (HA5430)

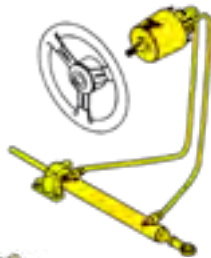

Inboard

### SeaStar Complete Inboard Steering System Set-4

Item Code 074182 „SYSTEM-4“ - 82kgm

**Number of turns: 4.25 lock-to-lock**

Components:

- Seastar 2,4 helm (HH5272-3)
- Alum. cylinder type BA150-7ATM (HC5314-3)
- 16m 3/8" nylon tubing (HT5101)
- fittings and 2l hydraulic oil (HA5430)

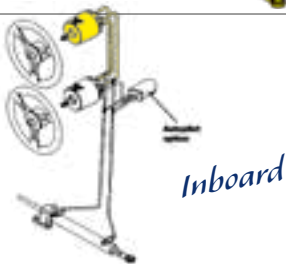

Inboard

### SeaStar Extension Kit Second Helm for: Set-4

Item Code 074182/2

**Kit for second helm position for Set-4**

Components:

- Seastar 2,4 helm (HH5272-3)
- ORB-Fitting kit (HF6010)
- 12m 3/8" nylon tubing (HT5101)
- 1l hydraulic oil (HA5430)

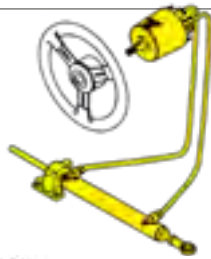

Inboard

### SeaStar Complete Inboard Steering System Set-5

Item Code 074110 „SYSTEM-5“ - 110kgm

**Number of turns: 5,5 lock-to-lock**

Components:

- Seastar 2,4 helm (HH5272-3)
- Brass cylinder type BA175-7TM (HC5319-3)
- 20m Seastar slangset (HO5132: 2 x 32')
- 3l hydraulic oil (HA5430)

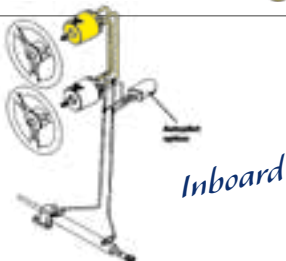

Inboard

### SeaStar Extension Kit Second Helm for: Set-5

Item Code 074110/2

**Kit for second helm position for Set-5**

Components:

- Seastar 2,4 helm (HH5272-3)
- ORB-Fitting kit (HF6005)
- 12m Seastar slangset (HO5120: 2 x 20')
- 1l hydraulic oil (HA5430)

**Item Code 074151 – 151kgm Complete system for 1 helm**  
**Number of turns: 5.5-11 lock-to-lock**  
**Components:**

- HH5250 Capilano 1250V helm
- HC5351 Brass cylinder type BA200-7TMB
- HA5731 Adapter hose kit copper tubing
- HF5590 1/2" Fitting kit
- HA5430 4l hydraulic oil (1/2" Copper tubing not included, HT5111)



**Capilano Complete Inboard Steering System Set-6**

Inboard



**Item Code 074151/2**  
**Kit for second helm position for Set-6**  
**Components:**

- HH5250 SeaStar 1250V
- HF5591 1/2" Fitting kit Dual Station
- HA5430 2l hydraulic oil



**Capilano Extension Kit Second Helm Set-6**

Inboard



**Itemcode 074228 - 228kgm Complete system for 1 helm**  
**Number of turns: 7.5-15 lock-to-lock**  
**Components:**

- HH5275 Capilano 1275V helm
- HC5379 Brass cylinder type BA200-11TMC
- HA5731 Adapter hose kit copper tubing
- HF5592 Fitting kit 5/8"
- HA5430 4l hydraulic oil (5/8" Copper tubing not included, HT5121)



**Capilano Complete Inboard Steering System Set-7**

Inboard



**Item Code 074228/2**  
**Kit for second helm position for Set-7**  
**Components:**

- HH5275 Capilano 1275V helm
- HF5593 5/8" Fitting kit Dual Station
- HA5430 2l hydraulic oil



**Capilano Extension Kit Second Helm Set-7**

Inboard



BOAT LENGTH	(SEMI)PLANING HULLS				DISPLACEMENT HULLS				SAIL
	1 ENGINE		2 ENGINES		1 ENGINE		2 ENGINES		1 ENGINE
P=PlASURE C=Commercial									
	P	C	P	C	P	C	P	C	
26 ft ( 8 m)	1	4	1	4	2	4	2	4	4
32 ft (10 m)	2	4	1	4	3	4	3	4	5
38 ft (11,5 m)	3	5	2	5	5	5	3	5	6
44 ft (13,5 m)	5	-	3	5	6	6	5	6	7
50 ft (15 m)	6/7	-	5/6	-	6/7	7	6/7	7	-
> 50 ft: SEASTAR POWER STEERING									

Hydraulic Inboard Steering Application Guide



**Item Code HA5445-2**  
 This self contained automatic filling- and purging system takes away all the pain and frustration out of purging a SeaStar or BayStar hydraulic steering system.

Power Purge



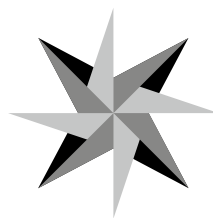

# Stern Drive Steering

Steering Config.	Engine / Drive Description	Year	Cylinder Description Model No.	Part No.	Number Turns Lock to Lock		Stroke	
					SeaStar HH5271	SeaStar HH5272		
Mercruiser	Non power assist	Mercruiser I	1983 & Prior	BA125-8EMV	HC5330-3	4.9	N/A	203mm
		Alpha I	1984 to date	BA135-7EM	HC5332*	5.0	3.5	178mm
		Bravo I, II, III	1984 to Date	BA135-7EM	HC5332*	5.0	3.5	178mm
Mercruiser	Power assist	Mercruiser I	1983 & Prior	125-8EM	HC5328-3	4.9/5.8	3.4/4.1	203mm
		Alpha I	1984 to date	125-8EM	HC5328-3	4.9/5.8	3.4/4.1	203mm
		Bravo I, II	1984 to date	125-8EM	HC5328-3	4.9/5.8	3.4/4.1	203mm
		Bravo III	1984 to date	125-8EM	HC5328-3	4.9/5.8	3.4/4.1	203mm
OMC	Non power assist	400/800 Series	1985 & Prior	N/A	N/A	N/A	N/A	
		Cobra	1986 to date	BA150-7EM	HC5326-3	6.0	N/A	178mm
		King Cobra	1986 to date	BA150-7EM	HC5326-3	6.0	N/A	178mm
OMC	Power assist	400/800 Series	1985 & Prior	N/A	N/A	N/A	N/A	
		Cobra	1986 to date	125-8EM	HC5328-3	4.9/5.8	3.4/4.1	203mm
		King Cobra	1986 to date	125-8EM	HC5328-3	4.9/5.8	3.4/4.1	203mm
Volvo	Non power assist	275	To date	BA150-7ATM	HC5314-3	6.0	N/A	178mm
		280, 290	2000 to date	BA135-7EM	HC5332*	5.0	3.5	178mm
		Diesel	2000 to date	BA135-7EM	HC5332*	5.0	3.5	178mm
		270	To date	BA125-8EMV	HC5330-3	4.9	N/A	203mm
Volvo	Power assist	275	To date	N/A	N/A	N/A	N/A	
		280, 290	To date	125-8EM	HC5328-3	4.9/5.8	3.4/4.1	203mm
		Diesel	To date	125-8VEM	HC5329-3	4.9/5.8	3.4/4.1	203mm
		32, Diesel	1997 to date	92-VPS	HC5331-3	4.9/5.8	3.4/4.1	203mm
		41-42, Diesel	1992 to date	92-VPS	HC5331-3	4.9/5.8	3.4/4.1	203mm
		DPS & SX	1996 to date	92-VPS	HC5331-3	4.9/5.8	3.4/4.1	203mm

**Revision Date:** April 2018

\*HC5332 replaces HC5326 as of January 2000.



**Item Code 074028** **Kit** for Mercruiser, Volvo 280-290, OMC Cobra & King Cobra, Yamaha & Yanmar >'89, all with power assist

**Item Code 074128** Idem, but with tilt helm (HH6541-3)

**Components:**

- Item Code HH5271-3 (or HH6541-3) Helm
- Item Code HC5328-3 Cylinder
- Item Code HA5430 Hydraulic oil (2x 1l)
- Item Code HT5101 Nylon tubing 20m
- All fittings

**SeaStar Hydraulic Stern Drive Steering Kits**

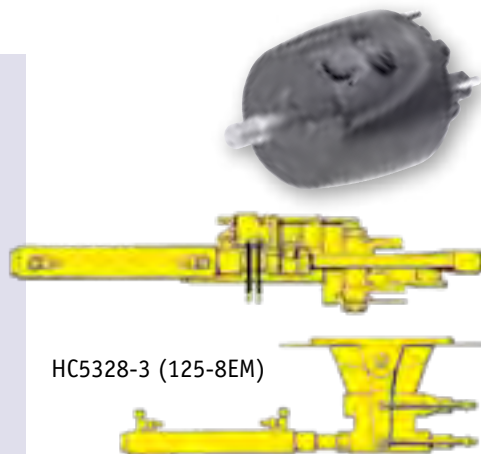

**Item Code 074029** **Kit** for Volvo "Diesel" with power assist

**Item Code 074129** Idem, but with tilt helm (HH6541-3)

**Components :**

- Item Code HH5271-3 (or HH6541) Helm
- Item Code HC5329-3 Cylinder
- Item Code HA5430 Hydraulic oil (2x 1l)
- Item Code HT5101 Nylon tubing 20m
- All fittings

**SeaStar Hydraulic Stern Drive Steering Kits**

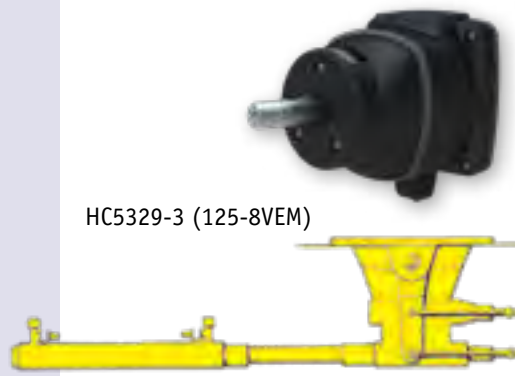

**Item Code 074030** **Kit** for older Mercruisers & BMW's, without power assist

**Item Code 074130** Idem, but with tilt helm (HH6541-3)

**Components :**

- Item Code HH5271-3 (or HH6541-3) Helm
- Item Code HC5330-3 Cylinder
- Item Code HA5430 Hydraulic oil (2x 1l)
- Item Code HT5101 Nylon tubing 20m
- All fittings

**SeaStar Hydraulic Stern Drive Steering Kits**

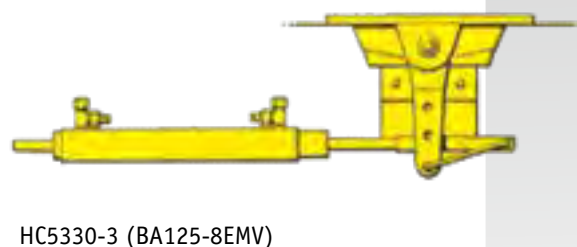

**Item Code 074031** **Kit** for Volvo 32, 41-42, "Diesel", DPS & SX, Yamaha DPS (TRP) all with power assist

**Item Code 074131** Idem, but with tilt helm (HH6541-3)

**Components :**

- Item Code HH5271-3 (or HH6541-3) Helm
- Item Code HC5331-3 Cylinder
- Item Code HA5430 Hydraulic oil (2x 1l)
- Item Code HT5101 Nylon tubing 20m
- All fittings

**SeaStar Hydraulic Stern Drive Steering Kits**

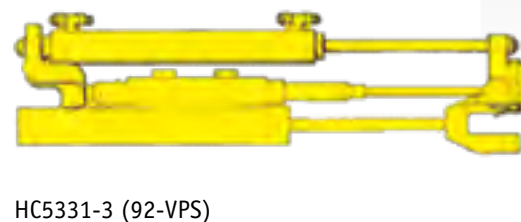

**Item Code 074032** **Kit** for Mercruiser Alpha 1, Bravo I, II, III and Volvo SX, "Diesel" all without powerassist

**Item Code 074132** Idem, but with tilt helm (HH6541-3)

**Components :**

- Item Code HH5271-3 (or HH6541-3) Helm
- Item Code HC5332 Cylinder
- Item Code HA5430 Hydraulic oil (2x 1l)
- Item Code H05116 SeaStar Outboard Hose only!
- All fittings

**SeaStar Hydraulic Stern Drive Steering Kits**

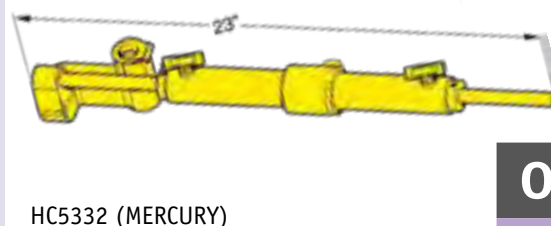



Round Bezel Kit. Reduces helm protrusion by 3.75" (95mm).



**Item Code HA5478** from 2009

**Item Code HA5417** till 2009

**Item Code HA5476** for Baystar (HH4314-3)



**Item Code HA5418** Backplate Kit

Reduces helm protrusion by thickness of dash and allows clean retrofit of pre-1991 SeaStar helms, System, hydraulic H50, H60, H80 & H 100. Mechanical: Safe-T, Big-T.

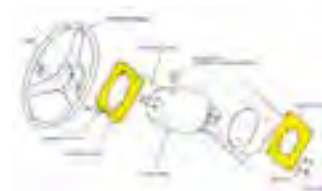

**Dashkit 20°**

**Item Code HA5419**

Dashkit 20° for SeaStar hydraulic helms.



**Nylon Tubing**

**Item Code HT5101**

3/8" (Ø 9.525 x 5.25mm). Supplied per meter. This tubing is suitable for hydraulic helms with a max. operating pressure of 70 bar (1000 psi). Can be connected with the nipples supplied with the SeaStar pump and cylinder.



**BayStar  
Hose Kit  
Standard**

**Item Code HT4420**

2 BayStar hydraulic hoses. Length 20' (6m) These hoses are suitable for helm pumps with a max. pressure of 70 bar (1000 psi). Swaged fitting at one side. The other side can be cut to measure and connected using the fittings supplied with the helm pump. Hose size 3/8" (Ø 9.525 x 5.25mm).

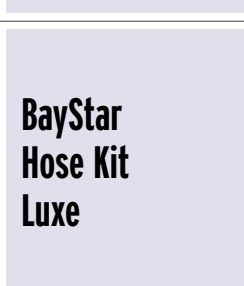

**BayStar  
Hose Kit  
Luxe**

**Item Code H05799**

2 BayStar Luxe Hydraulic hoses. Length 20' (6m) These extra flexible hoses are suitable for helm pumps with a max. operating pressure of 200 bar (2850 psi). Swaged fittings at one side. The other side can be cut to measures and connected with the nipples (057915) supplied with the hose. Hose size 1/4 "SAE 100R7 (Ø12 x 6.35mm).

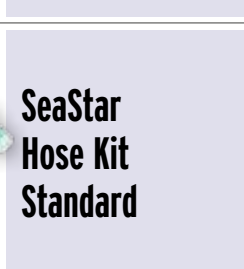

5/16" I.D. (7,94mm)

**SeaStar  
Hose Kit  
Standard**

**Item Code H05102 – H05132**

Complete sets with swaged fittings on both sides. Lengths from 2' till 32' (0,6 - 9,75m in increments of 2'). Internal diameter: 5/16" (7,94mm). These hoses are suitable for helm pumps with a max. operating pressure of 70 bar (1000 psi).

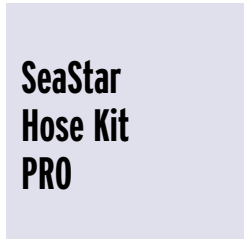

5/16" I.D. (7,94mm)

**SeaStar  
Hose Kit  
PRO**

**Item Code H05701 – H05730**

Complete sets with swaged fittings on both sides. Lengths from 1' till 30' (0,3 - 9,15m in increments of 2'). Internal diameter: 5/16" (7,94mm). These hoses are reinforced with Kevlar and suitable for helm pumps with a max. operating pressure of 105 bar (1500 psi).

Single, flexible and lockable bulkhead fitting. Black anodized aluminum mounting plate.

**Item Code HF5516** Bulkhead fitting only suitable for Nylon Hose (HT5101/HT4420) and BayStar deluxe Hose Kit (H05799)

### Bulkhead fitting

**NEW**



Set of flexible and lockable bulkhead fittings. Mounting plate made of plastic or stainless steel 316. Suitable for all SeaStar and BayStar deluxe Hoses.

**Item Code H07100** Bulkhead Kit, single hose, stainless  
**Item Code H07105** Bulkhead Kit, single hose, plastic  
**Item Code H07200** Bulkhead Kit, dual hose, stainless  
**Item Code H07205** Bulkhead Kit, dual hose, plastic

### Bulkhead fittings

**NEW**



### Item Code HA5471-2

The Cylinder Alignment Valve will allow for the periodic required realignment of two outboard motors or rudders that are not linked together with a mechanical tie bar.

### Liquid Tie Bar - Alignment Valve



### Item Code HF6010

ORB-Fitting kit voor extra stuurstand voor inboardbesturing

### ORB-Fitting kit



**Item Code AR4502** Smart Stick for Furuno and most other Autopilots. Output 0.5 - 4.5V.

**Item Code AR4502RM** Smart Stick for Ray Marine only. Output 2.2 - 2.8V.

**Item Code AR4502SI** Smart Stick for Simrad only. Output 2.8 - 4.0kHz.

### Smart Stick for Outboard Engines

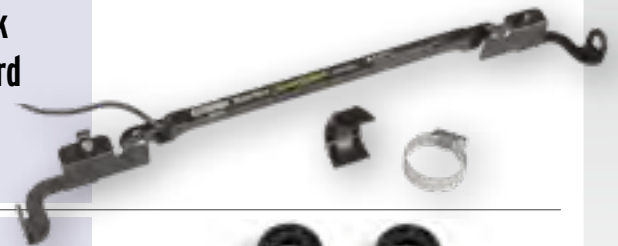

### Item Code H05090

Check application guide on page 38.

### Spacer kit for HC5345/48/58-3 Pivot Cylinder



### Item Code HA5820

### Pivot Plate Bushing Kit for cylinder HC5345/48/58-3



### Item Code HA5445-2

Self contained automatic filling- and purging system for SeaStar hydraulic steering.

### Power Purge



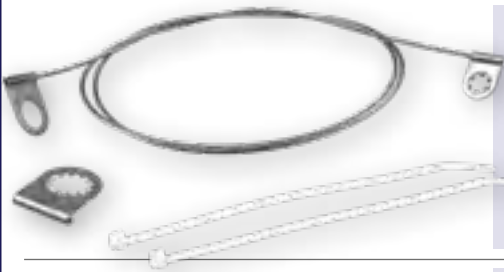

**Ground Strap**

**Item Code HA5477**

Ground Strap for SeaStar front-mount cylinder for salt water applications.  
(Is already supplied with a number of cylinders.)



**Bleed nipple caps**

**Item Code HP6044**

Bleed nipple caps  
All Seastar cylinders  
(12 x per kit)



**Fill Plugs for SeaStar Helms**

**Item Code HA5431 Vented Fill Plug**

**Item Code HA5432 Non-vented Fill Plug**  
For lower helm of dual station steering.



**Balljoint S/S**

**Item Code HP6003** S/S Balljoint 1/2" for tiebar

**Item Code HP6013** S/S Balljoint 5/8"

**Item Code HP6019** S/S Balljoint 3/4"

**Item Code HP6028** S/S Balljoint for HC5380-3 splashwell cylinder

**Item Code HP6029** S/S Balljoint for HC4461-3 BayStar cylinder

**Item Code HP6077** S/S Balljoint for ATM (aluminum) cylinders

**Item Code HP6137** S/S Balljoint 1/2" (7/16"x 20NF)



**Oil filler kit**

**Item Code HA5438**

Oil filler kit with fitting for helm and oil bottle.



**SeaStar Oil**

**Item Code HA5430**

SeaStar Hydraulic Oil, 1l





**HF5518**  
Vertical Bleeder Tee  
(2 per Kit)

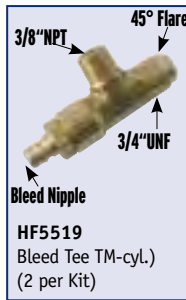

**HF5519**  
Bleed Tee TM-cyl.  
(2 per Kit)

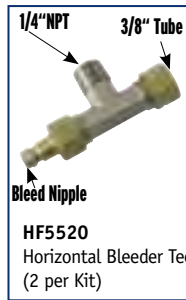

**HF5520**  
Horizontal Bleeder Tee  
(2 per Kit)

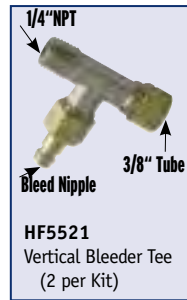

**HF5521**  
Vertical Bleeder Tee  
(2 per Kit)

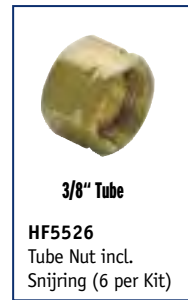

**HF5526**  
Tube Nut incl.  
Snijring (6 per Kit)



**HF5527**  
Union Coupling Fitting  
(3 per Kit)

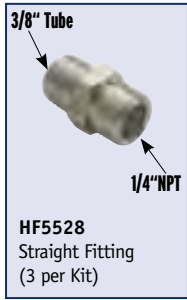

**HF5528**  
Straight Fitting  
(3 per Kit)



**HF5529**  
Elbow Fitting  
(3 per Kit)



**HF5530**  
Tee Fitting  
(3 per Kit)



**HF5531**  
Tee Fitting  
(3 per Kit)

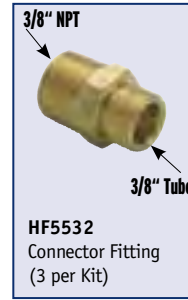

**HF5532**  
Connector Fitting  
(3 per Kit)

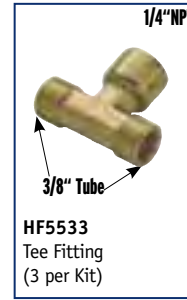

**HF5533**  
Tee Fitting  
(3 per Kit)



**HF5534**  
Elbow Fitting  
(3 per Kit)

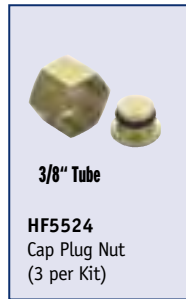

**HF5524**  
Cap Plug Nut  
(3 per Kit)



**HF5536**  
Tee Fitting  
(3 per Kit)

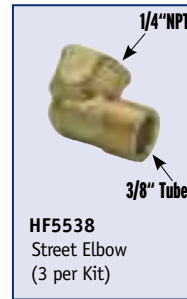

**HF5538**  
Street Elbow  
(3 per Kit)



**HF5548**  
Bleed Nipple  
(2 per Kit, incl. O-ring)



**HF5566**  
Adapter Fitting  
(2 per Kit)



**HF5512**  
Bulkhead Fitting Kit  
L=3/4", Single Cyl.  
(2 per Kit)



**HF5513**  
Bulkhead Fitting Kit  
L=3", Single Cyl.  
(2 per Kit)



**HF5514**  
Bulkhead Fitting Kit  
L=3/4", Twin Cyl.  
(2 per Kit)



**HF5515**  
Bulkhead Fitting Kit  
L=3", Twin Cyl.  
(2 per Kit)

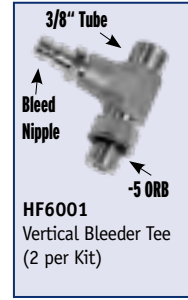

**HF6001**  
Vertical Bleeder Tee  
(2 per Kit)

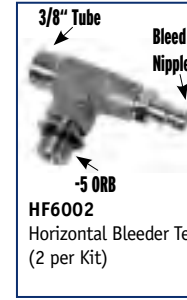

**HF6002**  
Horizontal Bleeder Tee  
(2 per Kit)



**HF6003**  
Hynautic Bleeder  
Tee. For use with  
5/16" or 3/8" hose.  
(2 per kit)

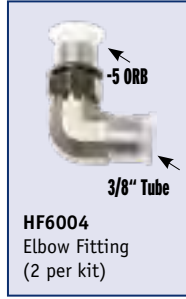

**HF6004**  
Elbow Fitting  
(2 per kit)



**HF6005**  
Tee Fitting  
(2 per kit)



**HF6006**  
Tee Fitting  
(2 per kit)



**HF6009**  
Straight Fitting  
(2 per kit)



**HF6011**  
45° Fitting  
(2 per kit)



**HF6012**  
Kit ORB Male to NPT  
Female (3 per kit)



**HF6007**  
Kit ORB add a Station for Outboards,  
incl. 3/8" tube: L=25'



**HF6010**  
Kit ORB add a Station for Inboards

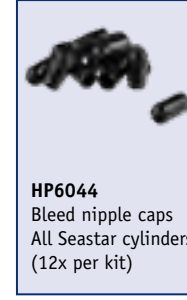

**HF6044**  
Bleed nipple caps  
All Seastar cylinders  
(12x per kit)

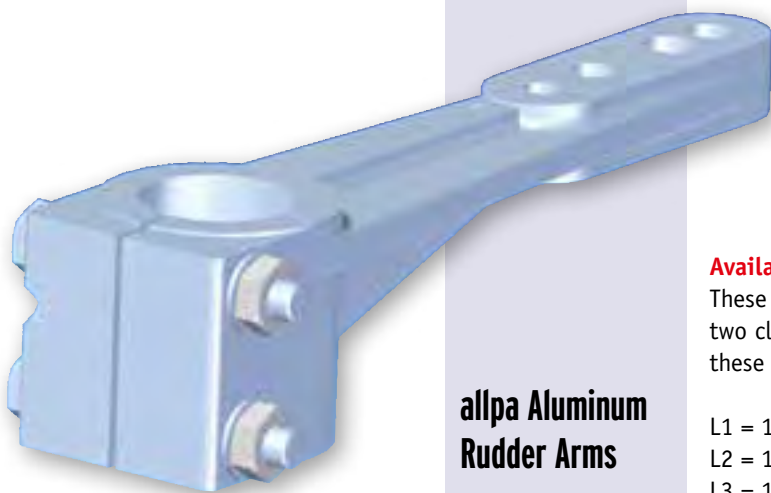

### alpa Aluminum Rudder Arms

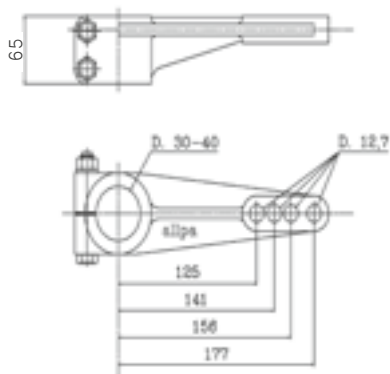

#### Available for $\varnothing 30\text{mm}$ and $\varnothing 40\text{mm}$ rudder stocks

These arms have a locking grub screw and are connected with two clamps. Due to the 4 attachment points (1/2" - 12mm) these arms are suitable for several hydraulic steering cylinders.

L1 = 125mm (2 x 45°)

L2 = 141mm (2 x 40°)

L3 = 156mm (2 x 35°)

L4 = 177mm (2 x 30°)

The above rudder angles are reached with 7" - stroke (178mm) Teleflex hydraulic cylinders.

**Item Code 562130** Rudder arm for  $\varnothing 30\text{mm}$  rudder stock

**Item Code 562140** Rudder arm for  $\varnothing 40\text{mm}$  rudder stock

See for appropriate steering cylinders or complete steering kits page 55-57.



### alpa Bronze Rudder Glands

#### Bronze glands for $\varnothing 30\text{mm}$ and $\varnothing 40\text{mm}$ rudder stocks with exchangeable bronze bearings and O-rings.

Available in two different lengths:

**Item Code 562230** Bronze gland,  $\varnothing 30\text{mm}$ ,

L<sub>1</sub> = 183mm, L<sub>2</sub> = 158mm

**Item Code 562231** Bronze gland,  $\varnothing 30\text{mm}$ ,

L<sub>1</sub> = 283mm, L<sub>2</sub> = 183mm

**Item Code 562240** Bronze gland,  $\varnothing 40\text{mm}$ ,

L<sub>1</sub> = 213mm, L<sub>2</sub> = 143mm

**Item Code 562241** Bronze gland,  $\varnothing 40\text{mm}$ ,

L<sub>1</sub> = 313mm, L<sub>2</sub> = 187mm

L<sub>1</sub> = Total length

L<sub>2</sub> = Thread length



**allpa®** supplies standard bronze rudders for boats from 5 till 30m, with flat or V-shaped keels or transom mount (0° or 12°). For speeds up to 35/40 knots (75 km/h). Rudder surface from 0,05 till 0,70 m².

These rudders come complete with rudder shaft, rudder trunk and tiller. Used materials depends on size and max. speed: manganese bronze (OT.MAN), aluminum bronze (NIBRAL) and stainless steel V.174 and AISI 216. Rudder and rudder trunk are always of the same material. Our rudders sizing is in compliance with the rules of the Italian Naval Register for pleasure boats.

Flat Keel Rudders	Model	Weight	Boat length:
Item Code 469012	12/ 6P	10kg	5- 8m
Item Code 469014	14/10P	14kg	8-12m
Item Code 469016	16/11P	13kg	8-12m
Item Code 469017	16/13P	21kg	8-12m

#### V-Keel Rudders

Item Code 469012/V	12/ 6V	10kg	5- 8m
Item Code 469014/V	14/10V	14kg	8-12m

#### Transom Mount Rudders

Item Code 469014/S-0	14/10S-0°	15kg	8-12m
Item Code 469014/S-12	14/10S-12°	15kg	8-12m

Above mentioned rudders are normally available from stock. However, the complete range is very extensive. Please ask for complete documentation.

Standard length rudder arm = 180mm

These rudders are built in series and therefore offer the following remarkable benefits:

- Lower price than one-off rudders
- Easy choice for designers from a large range of every hull shape in every size
- Exchangeable rudders: very practical during testing
- Simple exchangeable parts without professional assistance
- Maintenance free

**Item Code 469090** Service kit for rudder with shaft  $\varnothing$ 35mm

**Item Code 469091** Service kit for rudder with shaft  $\varnothing$ 40mm

## Bronze Rudders

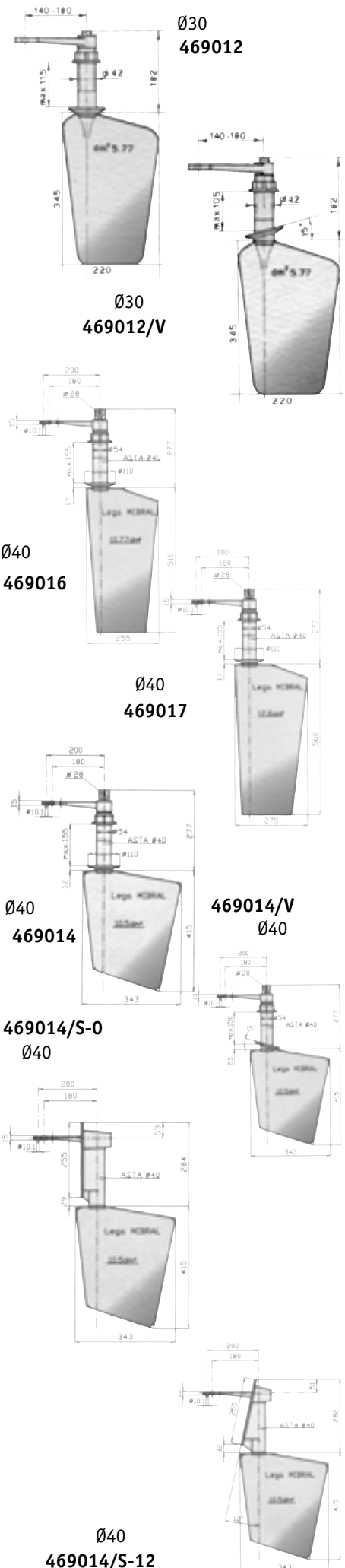



**Riviera**

3-Spoke, full plastic wheel  
 A = 350mm, B = 115mm  
**Item Code 062100** Black  
**Item Code 062101** White

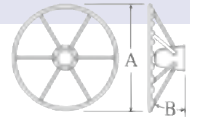

**TFX**

3-Spoke, full plastic wheel, Black  
 A = 350mm, B = 40mm  
**Item Code 064100**

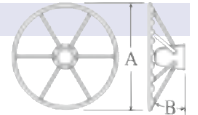

**Shark**

3-Spoke, full plastic wheel with Polyurethane rim.  
 A = 280mm, B = 55mm  
**Item Code 062500**

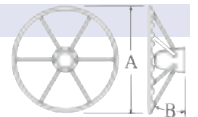

**Delfino**

**DELFINO BLACK**  
 3-Spoke, aluminum wheel with vinyl rim  
**Item Code 062102** A = 310mm, B = 95mm  
**Item Code 062103** A = 340mm, B = 95mm

**DELFINO WHITE**  
 3-Spoke, aluminum wheel with vinyl rim  
**Item Code 062102/W**  
 A = 310mm, B = 95mm  
**Item Code 062103/W**  
 A = 340mm, B = 95mm

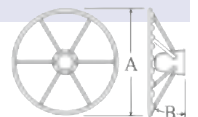

**Imola**

3-Spoke, silver aluminum wheel  
 with mahogany rim  
**Item Code 062107**  
 A = 310mm, B = 80mm

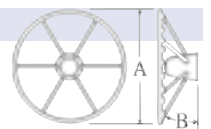

**Model „15“**

3-Spoke stainless steel wheel with mahogany rim  
**Item Code 068700**  
 A = 350mm, B = 40mm  
 With spline cone (Item Code 068988)  
 to set the wheel horizontal.  
 Also supplied with cone adapter  
 (Item Code 068998).

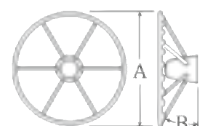

**Model „23“**

3-Spoke stainless steel wheel with vinyl rim  
**Item Code 068715** Black  
**Item Code 068716** White  
 A = 350mm, B = 60mm, cone 19mm

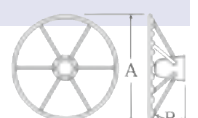

3-Spoke, silver aluminum wheel  
with black polyurethane grip

**Item Code 062145** A = 350mm, B = 90mm

**Item Code 062146** A = 350mm, B = 90mm

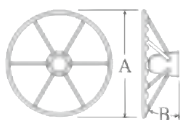

**Seahawk  
& Siren**



3x Double spoke stainless steel wheel

**Item Code 068725** With Teak wooden rim

**Item Code 068726** With black polyurethane rim

A = 350mm, B = 60mm, cone 19mm

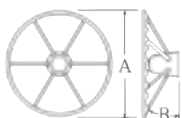

**Model  
„26 & 26L“**



3-Spoke stainless steel wheel

**Item Code 062148** With black polyurethane rim

A = 300mm

B = 60mm

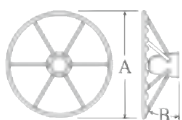

**Pegaso**



4x Double spoke stainless steel wheel

A = 350mm, B = 60mm

**Item Code 068721** Black polyurethane rim

**Item Code 068720** Wooden rim

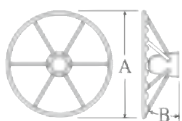

**Model „25B“**



3-Spoke stainless steel wheel

**Item Code 068710** with carbon-look rim

**Item Code 068711** with walnut-look rim

**Item Code 068712** with black polyurethane rim

A = 350mm, B = 60mm, cone 19mm

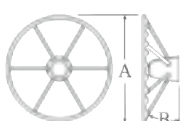

**Model „22“**



Sturdy, 3-Spoke, stainless steel wheel with polyurethane rim

**Item Code 062135** A = 350mm, B = 95mm

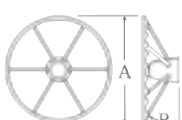

**Elica  
Polyurethaan**



3x Double spoke stainless steel wheel with black vinyl rim

**Item Code 068736** A = 350mm, B = 60mm



**Model „27B“**





**Leader Wood**

**Leader Prestige**

**LEADER WOOD**

6-Spoke stainless steel wheel with mahogany rim

**Item Code 062111** A = 360mm, B = 100mm

**Item Code 062111/T** A = 360mm, B = 100mm (TEAK!)

**Item Code 062112** A = 390mm, B = 100mm

**Item Code 062116** A = 550mm, B = 100mm

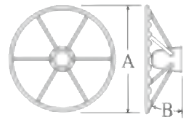

**LEADER PRESTIGE**

6-Spoke stainless steel wheel with rim and part of spokes of mahogany

**Itemcode 062118** A = 360mm, B = 100mm

**Itemcode 062119** A = 390mm, B = 100mm

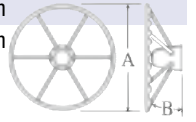

**Leader Elegant**

**Leader Silver**

**LEADER ELEGANT**

6-Spoke, stainless steel wheel with carbon look

**Item Code 062123** A = 370mm, B = 100mm

**LEADER SILVER**

6-Spoke, stainless steel wheel with silver look

**Item Code 062137** A = 370mm, B = 100mm

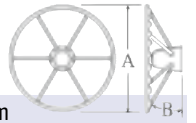

**Leader Tanegum Black**

**Leader Tanegum White**

**LEADER TANEGUM BLACK**

6-Spoke stainless steel wheel with black polyurethane rim

**Item Code 062109** A = 370mm, B = 100mm

**Item Code 062110** A = 410mm, B = 100mm

**LEADER TANEGUM WHITE**

6-Spoke stainless steel wheel with white polyurethane rim

**Item Code 062109/W**

A = 370mm, B = 100mm

**Item Code 062110/W**

A = 410mm, B = 100mm

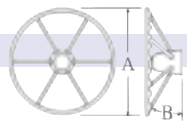

**S/S Steering Wheel**

**S/S Steering Wheel LUXE**

**5-Spoke stainless steel wheel**

*stainless steel 316*

**Item Code 078805** A = 343mm, B = 95mm, cone 19mm

**Item Code 078806** A = 394mm, B = 105mm, cone 19mm

**6-Spoke stainless steel wheel with finger grip**

**Item Code 078810** A = 343mm, B = 98mm, conus 19mm

**Item Code 078811** A = 394mm, B = 108mm, conus 19mm

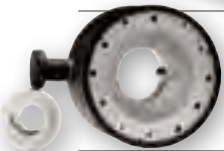
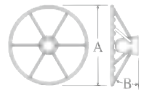

**Quick Release Hub**

For all wheels with Item Codes 062...

**Item Code 062180**



**Model „18“**

5-Spoke stainless steel wheel with carbon look rim

**Item Code 068705**

A = 350mm, B = 40mm

Also supplied with cone adapter (Item Code 068998).

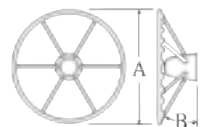

**S/S Steering Knob**

**Item Code 078825**

A=38mm, B = 50mm, C = 25mm

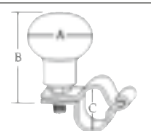

6-Spoke classic mahogany wheel  
Including insert to adapt to no. 2 different shaft cones

- Item Code 068237 Ø370mm
- Item Code 068249 Ø490mm
- Item Code 068265 Ø650mm

**TYPE-2  
STEERING WHEEL**



6-Spoke classic mahogany wheel with stainless steel rim  
Including insert to adapt to no. 2 different shaft cones

- Item Code 068342 Ø420mm
- Item Code 068349 Ø490mm
- Item Code 068360 Ø600mm
- Item Code 068370 Ø700mm
- Item Code 068380 Ø800mm

**TYPE-3  
STEERING WHEEL**



6-Spoke classic mahogany wheel with wooden rim  
Including insert to adapt to no. 2 different shaft cones

- Item Code 068346/B Ø460mm
- Item Code 068355/B Ø550mm
- Item Code 068360/B Ø600mm
- Item Code 068370/B Ø700mm

**TYPE-3B  
STEERING WHEEL**



**Type 6 (ref.1)**

6-Spoke classic mahogany wheel with wooden rim with finger grip. Including insert to adapt to no. 2 different shaft cones

- Item Code 068650 A = 500mm, B = 65mm
- Item Code 068670 A = 700mm, B = 65mm

**Type 6N (ref.2)**

6-Spoke classic teak wheel with wooden rim with finger grip. Including insert to adapt to no. 2 different shaft cones

- Item Code 068650/N A = 500mm, B = 60mm
- Item Code 068660/N A = 600mm, B = 60mm

**Type 6C (ref.3)**

6-Spoke carbon look wheel with finger grip. Including insert to adapt to no. 2 different shaft cones

- Item Code 068760 A = 600mm, B = 60mm

**TYPE 6  
STEERING WHEEL**

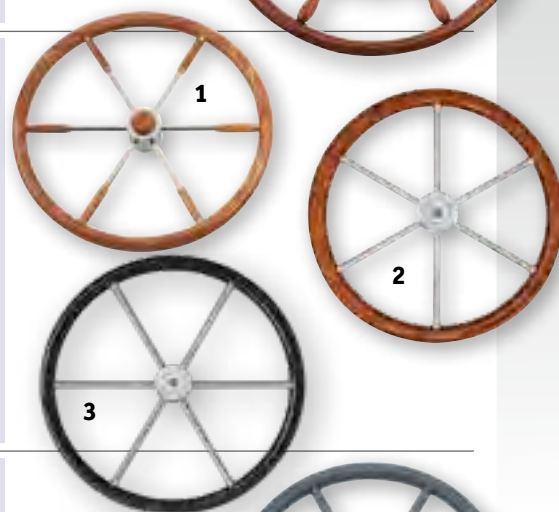
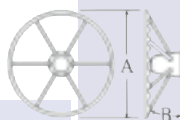

6-Spoke stainless steel wheel with black polyurethane rim and grip. Including insert to adapt to no. 2 different shaft cones

- Item Code 068945 A = 450mm, B = 60mm
- Item Code 068955 A = 550mm, B = 60mm
- Item Code 068970 A = 700mm, B = 60mm

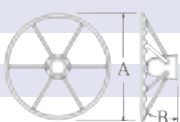

**TYPE-9  
STEERING WHEEL**



Item Code 068998

**CONE INSERT**

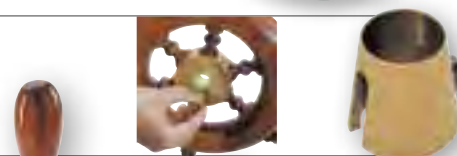

To be clamped on spoke (Ø13mm). Folding  
Item Code 068996

**STEERING  
HANDLE**

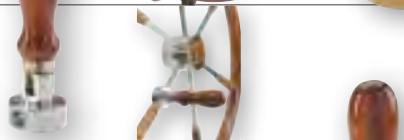

To be screwed. Folding  
Item Code 068997

**STEERING  
HANDEL**





**Eye terminal**

**Item Code 065893** Eye terminal (red nylon) for cables **CC230, CC330 & CCX633**  
**Item Code 065940** Eye terminal (Aluminium) for cables **CC230, CC330 & CCX633**  
**Item Code 065941** Eye terminal (Aluminium) for cable **CCX433**



**Isolator kit**

**Item Code 065960** Isolator kit for control cables **CC230, CC339 & CCX633**  
**Item Code 065961** Isolator kit for control cable **CCX433**



**Control Cable Bracket**

**Item Code A333**  
 With pre-mounted cable clamp (A314) For cables **CC230, CC330 & CCX633**

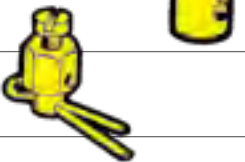

**Pivot**

**Item Code 065951** For cables **CCX433**  
**Item Code A312** For cables **CC230, CC330 & CCX633**



**Nipple**

**Item Code A313**  
 Nipple for control cables **CC170** and stop cables



**Clevis**

**Item Code A325** For cables **CC230, CC330 & CCX633**  
**Item Code A326** With inner thread 6mm  
**Item Code 065921** For cables **CCX433**



**Balljoint**

**Item Code A337** For cables **CC230, CC330 & CCX633**  
**Item Code 065931** For cables **CCX433**

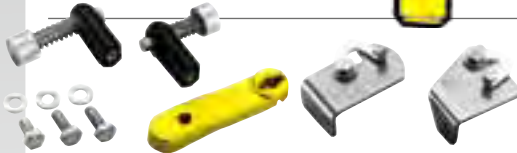

**Connection kit**

**Item Code 129184**  
 For cables **CC230, CC330 & CCX633** for Yamaha 25hp 2-T.



**Cable clamp**

**Item Code A314** For cables **CC230, CC330 & CCX633**  
**Item Code 065911** For 43C-cable

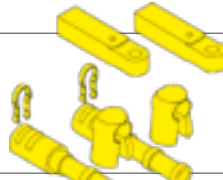

**Connection kit**

**Item Code CA27319**  
 For cables **CC230, CC330 & CCX633** for Mercury O/B & I/B

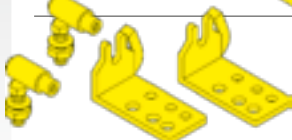

**Connection kit**

**Item Code CA27024**  
 Universal inboard kit for cables **CC230, CC330 & CCX633**

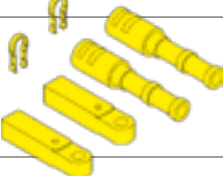

**Connection kit**

**Item Code CA27320** For cables **CC230, CC330 & CCX633** for OMC stern drives  
**Item Code CA27321** For cables **CC230, CC330 & CCX633** for OMC outboards

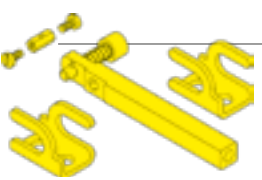

**Outboardkit**

**Item Code CA27208**  
 For OMC outboards to 35hp (< 1979)

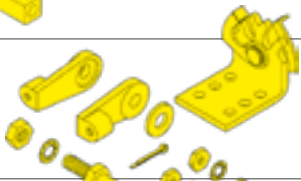

**Universal kit**

**Item Code CA27328**  
 Universal parallel connection kit for cables **CC230, CC330 & CCX633**

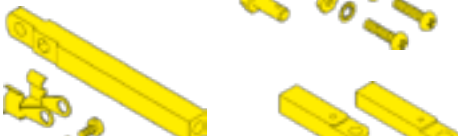

**Outboard- / stern drive kit**

**Item Code CA27247**  
 OMC outboard & stern drives <1979

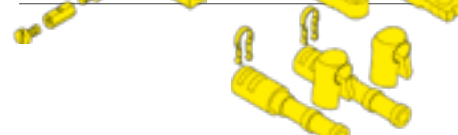

**Inboardkit**

**Item Code CA27373**  
 for Mercury I/B





# **Engine controls and control cables**

Engine Control Cables



**SEASTAR**  
By **DOMETIC**

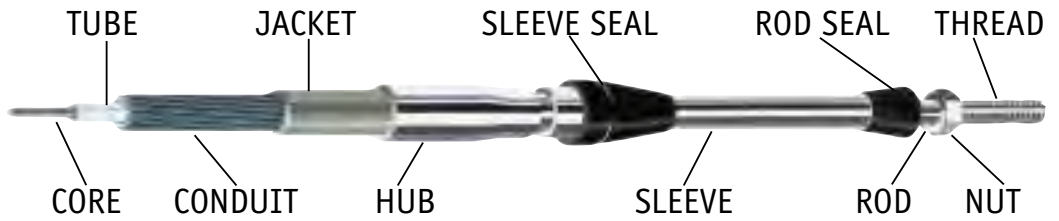







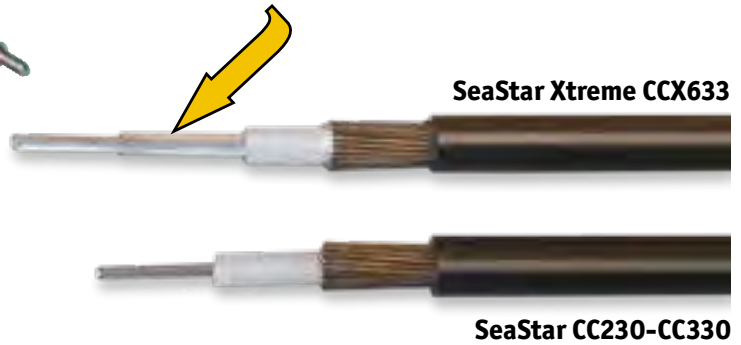

**Features:**

- Universal Push-Pull Cables
- Designed to fit outboards, inboards en stern drives
- Stainless steel core
- Stainless steel and brass fittings
- Heavy HDPE jacket
- Black jacket for best resistance to UV and chemicals
- Very smooth, efficient, strong and durable
- Cables meet/exceed all applicable industry standards

**Please indicate length when ordering**



 CC230xx	<p><b>Throttle/shift control cable</b></p>	<p>CC230 Inboard-, stern drive- and outboard engines: Yamaha, Suzuki, Tohatsu, Honda, Selva, Force, OMC Turbo Jet and Mercury Sport Jet.  <b>Nominal stroke 76mm. 10/32 UNF ends</b></p>
 CC330xx, CCx633xx	<p><b>Throttle/shift control cable</b></p>	<p>CC330 as CC230, but extra strong and with stainless steel end fittings.  <b>Nominal stroke: 76mm. 10/32 UNF ends</b></p>
 CC210xx	<p><b>Throttle/shift control cable</b></p>	<p>CC210 Mariner outboard engines ≤ 37kW (50HP)</p>
 CC179xx	<p><b>Throttle/shift control cable</b></p>	<p>CC179 Mercury and Mercruiser engines. Mariner engines (≥ 37kW / 50HP)</p>
 CC205xx	<p><b>Throttle/shift control cable</b></p>	<p>CC205 Johnson, Evinrude and OMC engines ≥ 1979 and OMC Sport Jet.</p>
 CC170xx	<p><b>Throttle/shift control cable</b></p>	<p>CC170 voor Johnson, Evinrude en OMC motoren &lt;1979</p>
 CC189xx „Gen II“	<p><b>Throttle/shift control cable</b></p>	<p>CC189 GenII für Mercury- und Mariner-Motoren &gt; 2003 from 50-60HP with topmount control</p>
 CCX433xx	<p><b>Throttle/shift control cable</b></p>	<p>CCX433 extra-heavy-duty control cable 1/4" x 28 UNF thread</p>

# Engine Control Cables

## Unique Selling Points:

- **Minimum bend radius 100mm!**  
Competition has 200mm...
- **Splined coated core wire!**  
Competition has solid concentric core...
- **Most efficient cables!**  
Black jacketed for best protection against environment!



### Standaard (CC172, CC2300)

#### CC230

CC230 06 ft  
CC230 07 ft  
CC230 08 ft  
CC230 09 ft  
CC230 10 ft  
CC230 11 ft  
CC230 12 ft  
CC230 13 ft  
CC230 14 ft  
CC230 15 ft  
CC230 16 ft  
CC230 17 ft  
CC230 18 ft  
CC230 19 ft  
CC230 20 ft  
etc.

### SeaStar Max Pro (33C, CC3300)

#### CC330

CC330 06 ft  
CC330 07 ft  
CC330 08 ft  
CC330 09 ft  
CC330 10 ft  
CC330 11 ft  
CC330 12 ft  
CC330 13 ft  
CC330 14 ft  
CC330 15 ft  
CC330 16 ft  
CC330 17 ft  
CC330 18 ft  
CC330 19 ft  
CC330 20 ft  
etc.

### SeaStar Xtreme

#### CCX633 (Xtreme)

CCX633 06 ft  
CCX633 07 ft  
CCX633 08 ft  
CCX633 09 ft  
CCX633 10 ft  
CCX633 11 ft  
CCX633 12 ft  
CCX633 13 ft  
CCX633 14 ft  
CCX633 15 ft  
CCX633 16 ft  
CCX633 17 ft  
CCX633 18 ft  
CCX633 19 ft  
CCX633 20 ft  
etc.

**1 ft = 30.48 cm**

Example: CC230 06 ft = 6 ft = 183 cm



**SEASTAR**

By DOMETIC

### Mercury - Mercruiser

#### CC179

CC179 06 ft  
CC179 07 ft  
CC179 08 ft  
CC179 09 ft  
CC179 10 ft  
CC179 11 ft  
CC179 12 ft  
CC179 13 ft  
CC179 14 ft  
CC179 15 ft  
CC179 16 ft  
CC179 17 ft  
CC179 18 ft  
CC179 19 ft  
CC179 20 ft  
etc.

### Mercury - Mercruiser

#### CCX179 (Xtreme)

CCX179 06 ft  
CCX179 07 ft  
CCX179 08 ft  
CCX179 09 ft  
CCX179 10 ft  
CCX179 11 ft  
CCX179 12 ft  
CCX179 13 ft  
CCX179 14 ft  
CCX179 15 ft  
CCX179 16 ft  
CCX179 17 ft  
CCX179 18 ft  
CCX179 19 ft  
CCX179 20 ft  
etc.

### Mercury - Mercruiser (Mercury Gen II)

#### CC189

CC189 6 ft  
CC189 7 ft  
CC189 8 ft  
CC189 9 ft  
CC189 10 ft  
CC189 11 ft  
CC189 12 ft  
CC189 13 ft  
CC189 14 ft  
CC189 15 ft  
CC189 16 ft  
CC189 17 ft  
CC189 18 ft  
CC189 19 ft  
CC189 20 ft  
etc.

### Mercury - Mercruiser (Mercury Gen II)

#### CCX189 (Xtreme)

-  
-  
-  
-  
CCX189 10 ft  
CCX189 11 ft  
CCX189 12 ft  
CCX189 13 ft  
CCX189 14 ft  
CCX189 15 ft  
CCX189 16 ft  
CCX189 17 ft  
CCX189 18 ft  
CCX189 19 ft  
CCX189 20 ft  
etc.

### OMC, Johnson Evinrude (OMC<1979)

#### CC170

CC170 06 ft  
CC170 07 ft  
CC170 08 ft  
CC170 09 ft  
CC170 10 ft  
CC170 11 ft  
CC170 12 ft  
CC170 13 ft  
CC170 14 ft  
CC170 15 ft  
CC170 16 ft  
CC170 17 ft  
CC170 18 ft

### OMC, Johnson, Evinrude

#### CC205

CC205 06 ft  
CC205 07 ft  
CC205 08 ft  
CC205 09 ft  
CC205 10 ft  
CC205 11 ft  
CC205 12 ft  
CC205 13 ft  
CC205 14 ft  
CC205 15 ft  
CC205 16 ft  
CC205 17 ft  
CC205 18 ft  
CC205 19 ft  
CC205 20 ft  
etc.

### Mariner

#### CC210

CC210 10 ft  
CC210 11 ft  
CC210 12 ft  
CC210 13 ft  
CC210 14 ft  
CC210 15 ft  
CC210 16 ft  
CC210 17 ft  
CC210 18 ft  
CC210 19 ft  
CC210 20 ft  
etc.

### Extra Heavy Duty (43C)

#### CCX433

CCX433 06 ft  
CCX433 07 ft  
CCX433 08 ft  
CCX433 09 ft  
CCX433 10 ft  
CCX433 11 ft  
CCX433 12 ft  
CCX433 13 ft  
CCX433 14 ft  
CCX433 15 ft  
CCX433 16 ft  
CCX433 17 ft  
CCX433 18 ft  
CCX433 19 ft  
CCX433 20 ft  
etc.



### Shut-Off Control Cable

**Shut-Off Cable complete with mounting kit and T-handle.**

- Item Code CC34305 05' (1,52m)
- Item Code CC34310 10' (3,05m)
- Item Code CC34315 15' (4,57m)
- Item Code CC34320 20' (6,10m) Available as a spare:
- Item Code CC34325 25' (7,62m)
- Item Code CC34330 30' (9,14m)
- Item Code CC34335 35' (10,68m)
- Item Code CC34340 40' (12,19m)



### T-handle "DC"



DC Control Converts standard 33C (CC230, CC330 & CCX633) cable into a utility control. Install through a panel or mount nearly anywhere with 30° mounting bracket.

**Item Code 065620**  
DC control complete with mounting bracket

With a Teleflex DS-unit it's easy to shift manoeuvring positions on board. The DS-unit is intended for shifting the gear function , e.g. manoeuvring the reverse gear or drive. For security reasons, you can only shift position when both controls are in neutral. When not connected the control is locked out.



Dual Station-Unit for throttle or shift  
**Item Code A323**

### Dual Station Units

Cables with extra short length for use with DS-units are available from stock. Please note: when changing station, the control handle must be in neutral position!!

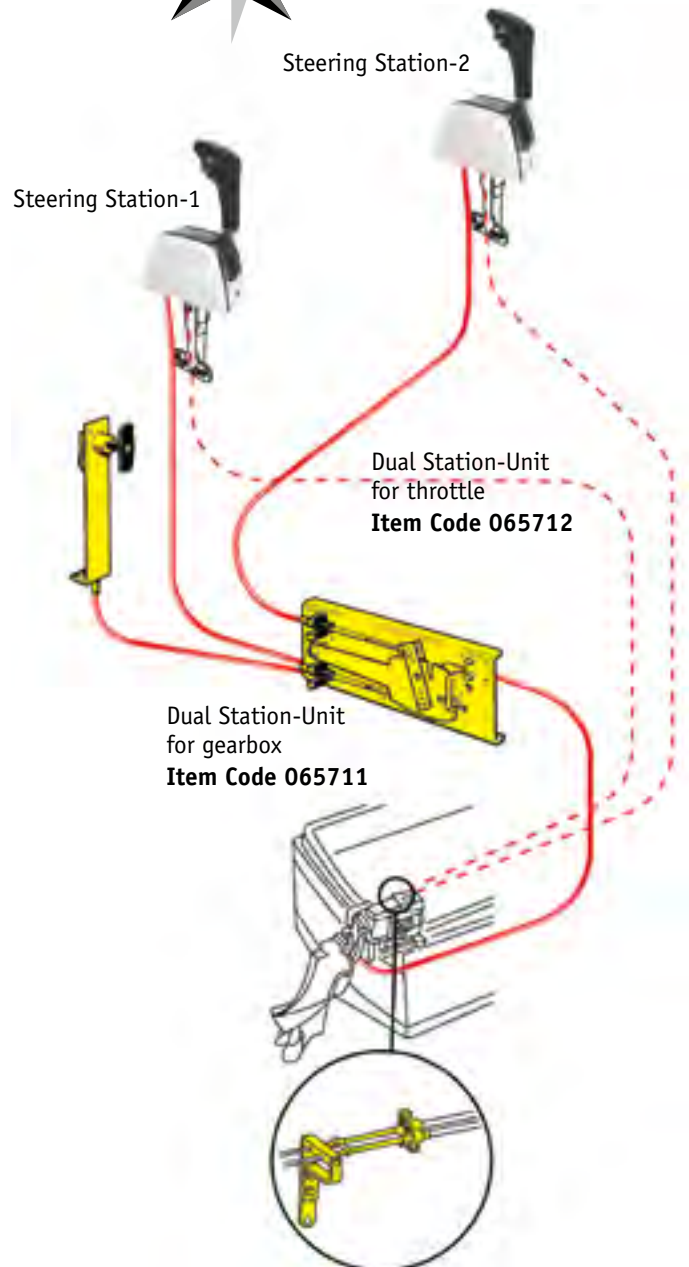

DS-Unit for throttle (pull to throttle only)  
**Item Code 065061**

### Dual Action Side Mount Control

For Throttle and Gear

For use with cables CC230, CC330 or CCX633

<b>Item Code 065006</b>	B80/S	Sailboat Design (172103-700SS)
<b>Item Code 065007</b>	B80	Standard (172105-700SM)
<b>Item Code 065008</b>	B80/L	With Neutral Interlock (172120-700SML)
<b>Item Code 065009</b>	B80/LT	With Neutral Interlock + Trim Switch (172121-700SMLT)
<b>Item Code 065010</b>	B80/T	With Trim Switch only (172133-700SMT)
<b>Item Code 065016</b>	B80/TR	For use with only no.1 Cable (172227) With grey handle
<b>Item Code 065025</b>	Neutral Safety Switch	

**B80  
B80/S**



B80

B80/S

### Dual Action Side Mount Control

For Throttle and Gear

For use with cables CC230, CC330 or CCX633

#### Features

- Stainless Steel lever
- CH2800 With momentary Switch to control Thruster or Windlass (IP 67, 2A-250 VAC/5A-120 VAC)
- Suitable for power or sail
- Can be mounted with or without cover plate
- Drop-in replacement for popular B80/S control

<b>Item Code CH2800</b>	CH2800 With Twist Grip Switch
<b>Item Code CH2850</b>	CH2850 Standard (no Switch)
<b>Item Code 065883</b>	Spare handle without Switch
<b>Item Code 065879</b>	Spare handle with Switch
<b>Item Code 065889</b>	Spare cover
<b>Item Code 065899</b>	Spare warm-up button
<b>Item Code 065054</b>	Spare locking screw
<b>Item Code 065025</b>	Neutral Safety Switch

**CH2800  
CH2850**

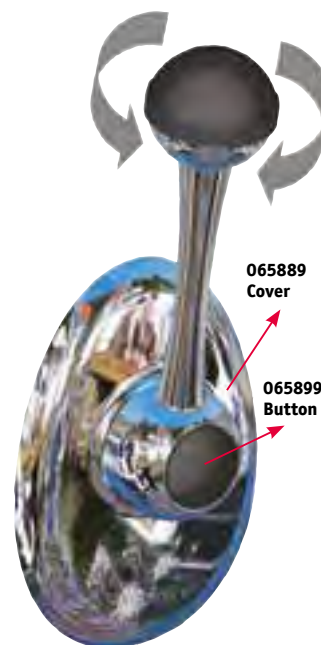

065889  
Cover

065899  
Button

### Center Console of Port Mount Dual Action Control

Universal design allows same Control for any Outboard-, Sterndrive- and Inboard engine power.

#### Features

- Suitable for use with all types of control cables 33C and engine specific cables: Mercury, Yamaha, BRP, Suzuki, Honda, Tohatsu en OMC/Johnson/Evinrude (≥ 1979)
- Trim Switch
- Neutral throttle warm up
- Neutral Interlock
- Neutral Safety Switch (Start-in-Gear-Protection)
- Emergency Stop Switch
- Adjustable friction
- Chrome Finish

<b>Item Code CHX8351</b>	Xtreme Control for Center Console- or Port mount
<b>Item Code 065905</b>	Spare Connection kit
<b>Item Code 065606</b>	Spare Neutral Safety Switch

**XTREME  
CONTROLS**

**CHX8351**

*With Trim Switch!*





## XTREME CONTROLS

**CHX8050**  
**CHX8051**  
**CHX8052**

### Xtreme Dual Action Side Mount Control

Universal design allows same Control for any Outboard-, Sterndrive- and Inboard engine power.

#### Features

- Suitable for use with all types of control cables 33C and engine specific cables: Mercury, Yamaha, BRP, Suzuki, Honda, Tohatsu en OMC/Johnson/Evinrude ( $\geq 1979$ )
- Trim Switch Option
- Tilt Switch Option
- Neutral throttle warm up
- Neutral Interlock
- Neutral Safety Switch (Start-in-Gear-Protection)
- Emergency Stop Switch
- Adjustable friction
- Chrome Finish

**Item Code CHX8050** Xtreme Side Mount Standard

**Item Code CHX8051** Xtreme Side Mount with Trim Switch

**Item Code CHX8052** Xtreme Side Mount with Trim Switch & Tilt Switch

**Item Code 065905** Spare Connection Kit

**Item Code 065606** Spare Neutral Safety Switch



## XTREME CONTROLS

**CHX8553**  
**CHX8554**  
**CHX8555**

**CHX8640**  
**CHX8641**

**CHX8740**  
**CHX8741**  
**CHX8742**

### Xtreme Dual Action Controls in Black

Universal design allows same Control for any Outboard-, Sterndrive- and Inboard engine power.

#### Features

- Suitable for use with all types of control cables 33C and engine specific cables: Mercury, Yamaha, BRP, Suzuki, Honda, Tohatsu en OMC/Johnson/Evinrude ( $\geq 1979$ )
- Trim Switch Option
- Tilt Switch Option
- Neutral throttle warm up
- Neutral Interlock (only CHX8553 Side Mount)
- Neutral Safety Switch (Start-in-Gear-Protection)
- Adjustable friction
- Black Finish

**Item Code CHX8553** Xtreme Side Mount with Neutral Interlock

**Item Code CHX8554** Xtreme Side Mount with Trim Switch & Neutral Interlock

**Item Code CHX8555** Xtreme Side Mount with Trim Switch & Tilt Switch

**Item Code CHX8640** Xtreme Top Mount, Single

**Item Code CHX8641** Xtreme Top Mount, Single with Trim Switch

**Item Code CHX8740** Xtreme Top Mount, Dual

**Item Code CHX8741** Xtreme Top Mount, Dual with Trim Switch

**Item Code CHX8742** Xtreme Topmount, Dual with Trim Switch & Tilt Switch

**Item Code 065905** Spare Connection Kit

**Item Code 065606** Spare Neutral Safety Switch

### Xtreme Dual Action Top Mount Control

Universal design allows same Control for any Outboard-, Sterndrive- and Inboard engine power.

#### Features

- Suitable for use with all types of control cables 33C and engine specific cables: Mercury, Yamaha, BRP, Suzuki, Honda, Tohatsu en OMC/Johnson/Evinrude (≥ 1979)
- Trim Switch Option
- Tilt Switch Option
- Neutral throttle warm up
- Neutral Interlock
- Neutral Safety Switch (Start-in-Gear-Protection)
- Adjustable friction
- Chrome Finish

<b>Item Code CHX8150</b>	Xtreme Top Mount, Single with Neutral Interlock
<b>Item Code CHX8151</b>	Xtreme Top Mount, Single with Trim Switch & Neutral Interlock
<b>Item Code CHX8152</b>	Xtreme Top Mount, Single with Trim- & Tilt Switch & Neutral Interlock
<b>Item Code 065905</b>	Spare Connection kit
<b>Item Code 065606</b>	Spare Neutral Safety Switch

### XTREME CONTROLS

**CHX8150**  
**CHX8151**  
**CHX8152**



### Dual Action Top Mount Control

Dual Action Control for Throtte and Gear.  
For use with cables CC230, CC330 or CCX633

#### Features

- Neutral throttle warm up
- Neutral Safety Switch (Start-in-Gear-Protection)
- Adjustable friction
- Completely Chromed

<b>Item Code 065601</b>	MT3 Single
<b>Item Code 065602</b>	MT3 TWIN
<b>Item Code 065605</b>	Kit MT3 to cable CCX433
<b>Item Code 065606</b>	Neutral Safety Switch
<b>Item Code 065603</b>	Spare Connection Kit MT3-Single
<b>Item Code 065604</b>	Spare Connection Kit MT3-TWIN

### MT3

*Original*

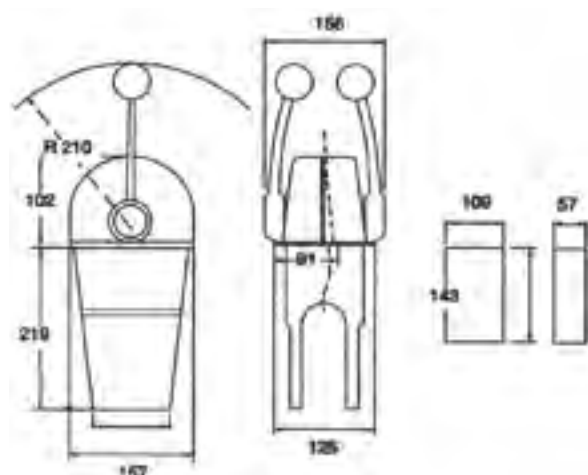



**XTREME  
CONTROLS**

**CHX8240  
CHX8241**

**Dual Action Top Mount Control**

Universal design allows same Control for any Outboard-, Sterndrive- and Inboard engine power.

**Features**

- Suitable for use with all types of control cables 33C and engine specific cables: Mercury, Yamaha, BRP, Suzuki, Honda, Tohatsu en OMC/Johnson/Evinrude (≥ 1979)
- Trim Switch Option
- Neutral throttle warm-up
- Neutral Safety Switch (Start-in-Gear-Protection)
- Adjustable friction
- Chrome Finish

<b>Item Code CHX8240</b>	Xtreme Top Mount with Neutral Interlock
<b>Item Code CHX8241</b>	Xtreme Top Mount with Neutral Interlock & Trim Switch
<b>Item Code 065905</b>	Spare Connection Kit
<b>Item Code 065606</b>	Spare Neutral Safety



**A80**



**Dual Action Top Mount Control**

For Throttle and Gear  
For use with cable **CC230, CC330** or **CCX633**

<b>Item Code 065001</b>	A80, Single, Standard (172107-700TS)
<b>Item Code 065002</b>	A80/L, Single, with Neutral Interlock (172122-700TSL)
<b>Item Code 065003</b>	A80/LT, Single with Neutral Interlock & Trim Switch (172123-700TSLT)
<b>Item Code 065004</b>	A80/T, Single, with Trim Switch (172135-700TST)
<b>Item Code 065005</b>	A80/D, TWIN, Standard (172109-700TD)
<b>Item Code 065015</b>	A80/DT, TWIN, with Trim Switch (172149-700TDT)
<b>Item Code 065025</b>	Neutral Safety Switch



**KB**

**Single Action Top Mount Control**

Popular for commercial boats  
For use with cable **CC230, CC330** or **CCX633**

<b>Item Code 065664</b>	KB Single - 1 x Gear (NB0702-00)
<b>Item Code 065665</b>	KB Single - 1 x Throttle (NB0701-00)
<b>Item Code 065666</b>	KB TWIN - 2 x Gear (NB0811-00)
<b>Item Code 065667</b>	KB TWIN - 1 x Throttle + 1 x Gear (NB0801-00)
<b>Item Code 065668</b>	KB TWIN - 2 x Throttle (NB0810-00)

With external adjustable friction.



### Single Action Side Mount Control

For use with only one cable.

For use with cable CC230, CC330 or CCX633

#### Features

- Durable heavy chrome finish
- External adjustable friction

Item Code 065610 STB Control

## STB CH2400



### Single Action Top Mount Heavy Duty Control

Popular on commercial vessels. One or two lever control.

For use with cables CC230, CC330 or CCX633

#### Features

- Durable heavy chrome finish
- The NB throttle control has a drag adjustment which is simply applied by twisting either lever to lock once the desired position has been established

Item Code 065670 NB Single Control -1 x Shift (NB0124-00)

Item Code 065671 NB Single Control -1 x Throttle (NB0125-00)

Item Code 065672 NB Twin Control -1xTrottle+1x Shift (NB0239-00)

## NB



### Single Action Top Montage Control

Popular on commercial vessels. One or two lever control.

For use with cables CC230, CC330 or CCX633

#### Features

- Durable heavy chrome finish
- External adjustable friction

Item Code 065630 S Single Control 1 x Throttle or 1 x Shift (NB0124-00 / CH5210)

Item Code 065631 S Twin Control 1 x Throttle + 1 x Shift (NB0239-00 / CH5200)

Item Code 065918 Optional gear detent kit

## S CH5200 CH5210



### Dual Action Side Mount Ski Boat Control

The alternative choice of the competitive ski boat driver.

For throttle and shift. For use with cables CC230, CC330 or CCX633

#### Features

- Pull-out clutch disengagement for warm-up
- Crisp, positive detents
- Built-in friction drag prevents throttle creep
- Neutral interlock to prevent accidental shifting

Item Code CH2900 MV-3 control

## MV-3 CH2900





**A89**  
**A90**

**Dual Action Side Mount Control**

For throttle and shift

**Features**

- Suitable for all 33C- type and engine specific cables: Yamaha, BRP, Suzuki, Honda, Tohatsu and OMC/Johnson/Evinrude (from 1979).
- Only for Mercury cableless CC179, CCX179 and Mariner CC210, the extra kit Item Code 34730 (K35-kit) is required.
- Body, handle and mechanism are all made of special plastic; all fitting are of stainless steel
- Neutral throttle warm up
- Neutral Interlock

**Item Code 35151** A89 Side Mount Control, white color

**Item Code 35152** A90 Side Mount Control, black color

**Item Code 35153** Spare Connection Kit)

**Item Code 34730** K35-kit for Mercury & Mariner cables



**C80**

**Dual Action Side Mount Control**

For throttle and shift

For use with cable **CC230**, **CC330** or **CCX633**

**Features**

- Aluminum handle and mechanism, plastic body
- Neutral Throttle warm up
- Neutral Interlock Option
- Trim-Switch Option

**Item Code 065011** C80 Control Standard (172101-700S0)

**Item Code 065014** C80/T Control with Trim Switch (17213101-700S0T)

**Item Code 065025** Neutral Safety Switch



**Spare Parts**

**Several Spare Parts** - (see controls for more parts)

**Code 065057** Connection kit A80/B80 & C80 controls

**Code 065058** Locking pin A80/B80 & C80 controls

**Code 065052** Black push button

**Code 065053** Red push button cap (B80/S)

**Code 065054** Locking screw handle B80/S + CH2800/2850

**Code 065059** Cover plate B80 & B80/S (not shown)









**Code 065050** Spare handle B80 (065007) (not shown)

**Code 065051** Spare handle B80/S (065006) (not shown)

**Code 065025** Neutral Safety Switch for A80, B80, C80, CH2800 & CH2850 controls (not shown)

**Code 065914** Black Ball Knob for several controls

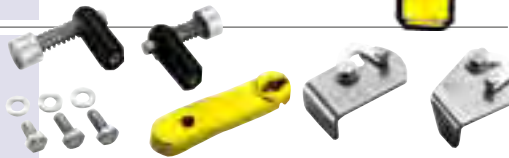
**Code 065916** Red Ball Knob for several controls

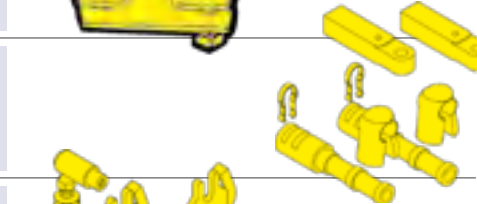
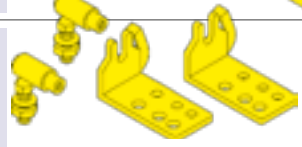
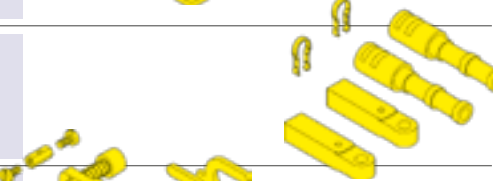
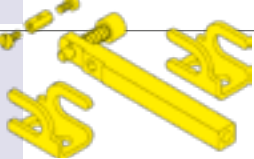
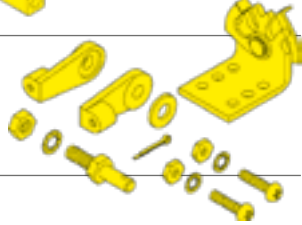
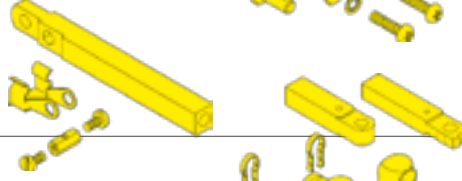
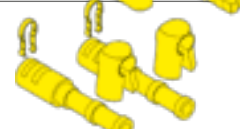
<p><b>Item Code 065893</b> Eye terminal (red nylon) for cables <b>CC230, CC330 &amp; CCX633</b></p> <p><b>Item Code 065940</b> Eye terminal (Aluminium) for cables <b>CC230, CC330 &amp; CCX633</b></p> <p><b>Item Code 065941</b> Eye terminal (Aluminium) for cable <b>CCX433</b></p>	<b>Eye terminal</b>	
<p><b>Item Code 065960</b> Isolator kit for control cables <b>CC230, CC339 &amp; CCX633</b></p> <p><b>Item Code 065961</b> Isolator kit for control cable <b>CCX433</b></p>	<b>Isolator kit</b>	
<p><b>Item Code A333</b> With pre-mounted cable clamp (A314) For cables <b>CC230, CC330 &amp; CCX633</b></p>	<b>Control Cable Bracket</b>	
<p><b>Item Code 065951</b> For cables <b>CCX433</b></p> <p><b>Item Code A312</b> For cables <b>CC230, CC330 &amp; CCX633</b></p>	<b>Pivot</b>	
<p><b>Item Code A313</b> Nipple for control cables <b>CC170</b> and stop cables</p>	<b>Nipple</b>	
<p><b>Item Code A325</b> For cables <b>CC230, CC330 &amp; CCX633</b></p> <p><b>Item Code A326</b> With inner thread 6mm</p> <p><b>Item Code 065921</b> For cables <b>CCX433</b></p>	<b>Clevis</b>	
<p><b>Item Code A337</b> For cables <b>CC230, CC330 &amp; CCX633</b></p> <p><b>Item Code 065931</b> For cables <b>CCX433</b></p>	<b>Balljoint</b>	
<p><b>Item Code 129184</b> For cables <b>CC230, CC330 &amp; CCX633</b> for Yamaha 25hp 2-T.</p>	<b>Connection kit</b>	
<p><b>Item Code A314</b> For cables <b>CC230, CC330 &amp; CCX633</b></p> <p><b>Item Code 065911</b> For 43C-cable</p>	<b>Cable clamp</b>	
<p><b>Item Code CA27319</b> For cables <b>CC230, CC330 &amp; CCX633</b> for Mercury O/B &amp; I/B</p>	<b>Connection kit</b>	
<p><b>Item Code CA27024</b> Universal inboard kit for cables <b>CC230, CC330 &amp; CCX633</b></p>	<b>Connection kit</b>	
<p><b>Item Code CA27320</b> For cables <b>CC230, CC330 &amp; CCX633</b> for OMC stern drives</p> <p><b>Item Code CA27321</b> For cables <b>CC230, CC330 &amp; CCX633</b> for OMC outboards</p>	<b>Connection kit</b>	
<p><b>Item Code CA27208</b> For OMC outboards to 35hp (&lt; 1979)</p>	<b>Outboardkit</b>	
<p><b>Item Code CA27328</b> Universal parallel connection kit for cables <b>CC230, CC330 &amp; CCX633</b></p>	<b>Universal kit</b>	
<p><b>Item Code CA27247</b> OMC outboard &amp; stern drives &lt;1979</p>	<b>Outboard- / stern drive kit</b>	
<p><b>Item Code CA27373</b> for Mercury I/B</p>	<b>Inboardkit</b>	

## KE ELECTRONIC ENGINE CONTROLS

# NHK MEC

Controls for inboard, outboard or stern-drive engines.

KE Systems are a perfect answer to smooth and easy shift and throttle control suitable for most applications.

Moderne styling, various control head options, single to quad engine capability.



**INBOARD STYLE TWIN CONTROL HEAD**



1. Port control lever  
With optional trim control button.
2. Starboard control lever
3. Throttle zone for lever
4. LED's indicate shift position (FNR)
5. LED indicates sync function
6. SELECT & SYNC activation buttons

**OUTBOARD STYLE  
TWIN CONTROL HEAD**



## KE ELECTRONIC CONTROL SYSTEM SELECTION GUIDE TABEL

Control	Mechanical Throttle	Mechanical Shift	Electronic Throttle	Electronic Shift
KE-4+				
KE-5+				
KE-6+				
KE-7+				

### Features

- Designed for new Installation or Retrofit
- Controls for Inboard, Outboard or Stern-Drive Engines; gas or diesel; 12-24V DC
- Up to 4 stations + 1 Hand Held
- 1 to 4 engine capability
- Neutral warm up function
- Complete self-diagnostic system
- Adjustable shift / throttle settings
- Start in gear protection

### Options

- Idle control
- Audible alarm
- Outboard Style levers / Trim Control
- Trolling outputs
- Display dimmer
- Handheld Control
- System settings tool
- Integrated sync function
- Mechanical backup



Handheld option sample

# NHK MEC



# KE-4+ SERIES ELECTRONIC CONTROL SYSTEM: OUTBOARD STYLE HEAD



**For engines with:**  
 - Mechanical Throttle  
 - Mechanical Shift



KE-4+ Series Control System CANbus	
Maximum Work Load	343N (35 kgf)
Supply Voltage	12V/24V DC (DC 9V-31V)
Current Consumption	0.5A Stand By
Starting Current Actuator	16A Max, 49N (5 kgf) load
Operating Thrust	147N (15 kgf)
Shift Travel	40mm Max forward & reverse - adjustable
Temperature Environment	-20°C / +77°C (-4°F / 170°F)
Throttle Travel	80mm Max - adjustable

ORDER INFORMATION:				Single Engine		Dual Engine		Note	
				No. of Stations	No. of Stations	No. of Stations	No. of Stations		
No.	Description	Ref.	Code	1	2	1	2		
1	Control Head Single (PTT), LH Outboard Style + Trim/Tilt	NM1001-00	064750	1	2	-	-		
2	Control Head Twin (PTT) Outboard Style + Trim/Tilt	NM1051-00	064755	-	-	1	2		
1-1	Control Head Single, LH Outboard Style, zonder Trim	NM1002-00	064757	1	2	-	-	option	
2-1	Control Head Twin Outboard Style, zonder trim	NM1052-00	064832	-	-	1	2	option	
3	Control Unit 12V/24V DC	NM1475-00	064754	1	1	2	2		
4	Actuator 12/24V DC	NM0183-00	064752	1	1	2	2		
5	CANbus Harness (Other lengths available upon request)	4m	NM0649-04	1	2	2	3	Please specify required harness length!	
		8m	NM0649-08						064778
		10m	NM0649-10						064779
		14m	NM0649-14						064782
		18m	NM0649-18						064784
		20m	NM0649-20						064785
		30m	NM0649-30						064788
6	Harness Power Supply	5m	NM0414-28	064830	2	2	4	4	Length
		10m	NM0414-33	064831					
7	T-Harness (R/C-1) N	NM0647-09	064761	1	1	1	1		
8	T-Harness (R/C)	NM0647-10	064762	-	1	-	1		
9	T-Harness (Single)	NM0647-11	064763	1	1	-	-		
10	T-Harness (Port)	NM0647-12	064764	-	-	1	1		
11	T-Harness (STBD)	NM0647-13	064765	-	-	1	1		
12	Circuit Breaker 20A	NJ0514-00	064922	2	2	4	4	Option	
13	Buzzer 12V	NJ0251-00	064920	1	2	1	2	Option	
	Buzzer 24V	NJ0515-00	064921						
14	Idle Switch	NJ0765-00	064766	1	2	1	2	Option	
15	Idle Switch Extension Harness	NM0647-08	064760	1	2	1	2	Option	
16	Mechanical Cable	TFXtreme	CCX633	2	2	4	4	Length	
17	Trim Circuit Harness	NJ0772-00	064767	1	2	1	2	PTT only	
<b>Complete sets:</b>				Code 064741	Code 064742	Code 064743	Code 064744		

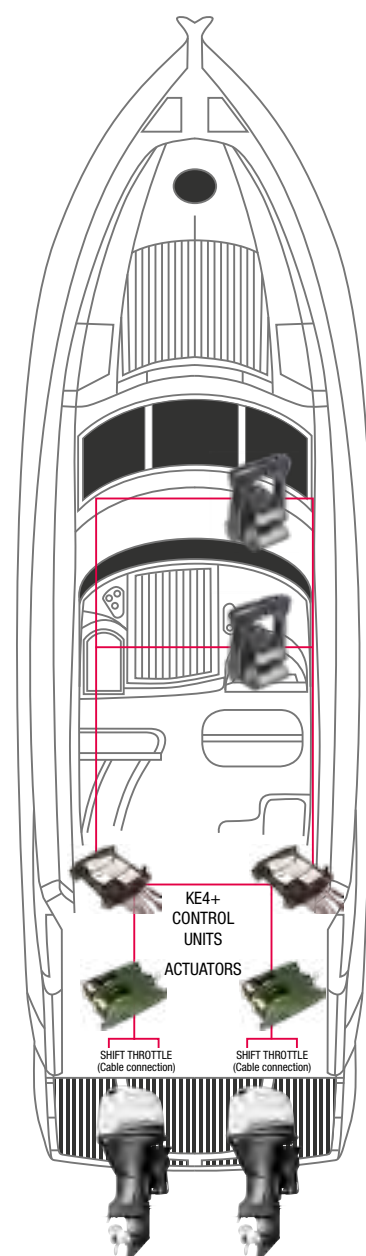

**With Unique Mechanical Backup-Function!!**  
 Handheld Control & Trolling System see page 89

# KE-4+ SERIES ELECTRONIC CONTROL SYSTEM: INBOARD STYLE HEAD

For engines with:

- Mechanical Throttle
- Mechanical Shift



KE-4+ Series Control System CANbus	
Maximum Work Load	343N (35 kgf)
Supply Voltage	12V/24V DC (DC 9V-31V)
Current Consumption	0.5A Stand By
Starting Current Actuator	16A Max, 49N (5 kgf) load
Operating Thrust	147N (15 kgf)
Shift Travel	40mm Max forward & reverse – adjustable
Temperature Environment	-20°C / +77°C (-4°F / 170°F)
Throttle Travel	80mm Max - adjustable

ORDER INFORMATION:				Single Engine		Dual Engine		Note	
				No. of Stations	No. of Stations	No. of Stations	No. of Stations		
No.	Description	Ref.	Code	1	2	1	2		
1	Control Head Single (SST) Inboard Style (LH)	NM1003-00	064751	1	2	-	-		
1a	Control Head Single (SST) Inboard Style (RH)	NM1018-00	064758	1	2	-	-	option	
2	Control Head Twin (SST) Inboard Style	NM1053-00	064756	-	-	1	2		
3	Control Unit 12V/24V DC	NM1475-00	064754	1	1	2	2		
4	Actuator 12/24V DC	NM0183-00	064752	1	1	2	2		
5	CANbus Harness (Other lengths available upon request)	4m	NM0649-04	1	2	2	3	Please specify required harness length!	
		8m	NM0649-08						064778
		10m	NM0649-10						064779
		14m	NM0649-14						064782
		18m	NM0649-18						064784
		20m	NM0649-20						064785
		30m	NM0649-30						064788
6	Harness Power Supply	5m	NM0414-28	2	2	4	4		
		10m	NM0414-33	064831					
7	T-Harness (R/C-1) N	NM0647-09	064761	1	1	1	1		
8	T-Harness (R/C)	NM0647-10	064762	-	1	-	1		
9	T-Harness (Single)	NM0647-11	064763	1	1	-	-		
10	T-Harness (Port)	NM0647-12	064764	-	-	1	1		
11	T-Harness (STBD)	NM0647-13	064765	-	-	1	1		
12	Circuit Breaker 20A	NJ0514-00	064922	2	2	4	4	Option	
13	Buzzer 12V	NJ0251-00	064920	1	2	1	2	Option	
	Buzzer 24V	NJ0515-00	064921						
14	Idle Switch	NJ0765-00	064766	1	2	1	2	Option	
15	Idle Switch Extension Harness	NM0647-08	064760	1	2	1	2	Option	
16	Mechanical Cable	TFXtreme	CCX633	2	2	4	4	Length!	
<b>Complete sets:</b>				Code 064731	Code 064732	Code 064733	Code 064734		

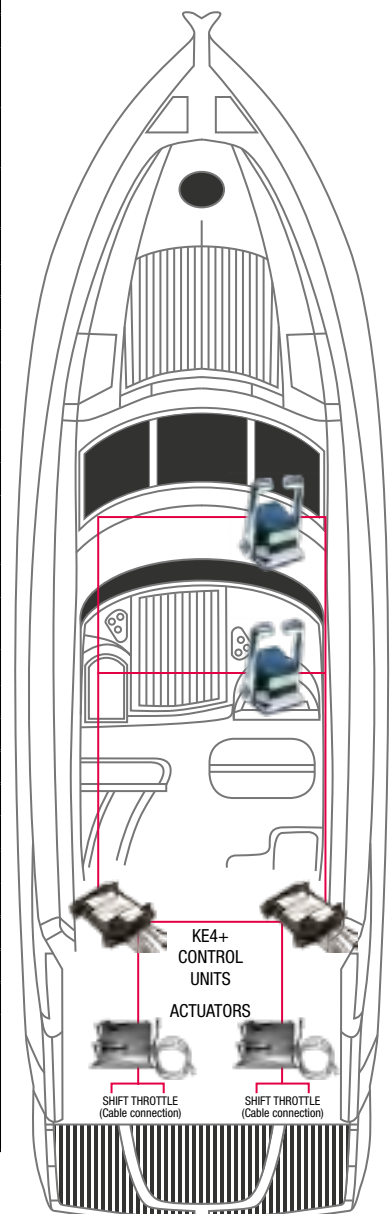

**With Unique Mechanical Backup-Function!!**  
Handheld Control & Trolling System see page 89

# KE-5+ SERIES ELECTRONIC CONTROL SYSTEM "de LUXE" for INBOARDS

**For engines with:**

- Electronic Throttle
- Electronic Shift



KE-5+ Series Control System CANbus	
Supply Voltage	12V/24V DC (DC 9V-31V)
Current Consumption	0.5A Stand By
Throttle Output	Type 1 Current: 4Ma to 20Ma, Cap. 24V, 2A max
	Type 2 Voltage: 0.2V to 4.5V, Cap. 24V, 2A max
	Type 3 PWM: 6% to 94% Duty Cycle, 500Hz, Cap. 24V, 2A max
	Type 4 CAN (SAE J1939), Cap. 24V, 2A max
Shift Output	Solenoid Activation, Cap. 9A max
IVS Switches	Normally Open & Normally Closed
Operating Environment	-20°C / +77°C (-4°F / 170°F)

ORDER INFORMATION:					Single Engine		Dual Engine		Note
					No. of Stations	No. of Stations	No. of Stations	No. of Stations	
No.	Description	Ref.	Code	Code	1	2	1	2	
1	Control Head Single (SST) Inboard Style (LH)		NM1003-00	<b>064751</b>	1	2	-	-	
1a	Control Head Single (SST) Inboard Style (RH)		NM1018-00	<b>064758</b>	1	2			Option
2	Control Head Twin (SST) Inboard Style		NM1053-00	<b>064756</b>	-	-	1	2	
3	Control Unit 12V/24V DC		NM2406-00	<b>064867</b>	1	1	2	2	
4	CANbus Harness (Other lengths available upon request)	4m	NM0649-04	<b>064776</b>	1	2	2	3	Please specify required harness length!
		8m	NM0649-08	<b>064778</b>					
		10m	NM0649-10	<b>064779</b>					
		14m	NM0649-14	<b>064782</b>					
		18m	NM0649-18	<b>064784</b>					
		20m	NM0649-20	<b>064785</b>					
		30m	NM0649-30	<b>064788</b>					
5	Harness Power Supply	5m	NM0414-28	<b>064830</b>	2	2	4	4	Length
		10m	NM0414-33	<b>064831</b>					
7	T-Harness (R/C-1)		NM0647-09	<b>064761</b>	1	1	1	1	
8	T-Harness (R/C)		NM0647-10	<b>064762</b>	-	1	-	1	
9	T-Harness (Single)		NM0647-11	<b>064763</b>	1	1	-	-	
10	T-Harness (PORT)		NM0647-12	<b>064764</b>	-	-	1	1	
11	T-Harness (STBD)		NM0647-13	<b>064765</b>	-	-	1	1	
12	Harness, Shift	5m	NM0640-05	<b>064955</b>	1	1	2	2	Length
		10m	NM0640-10	<b>064979</b>					
13	Harness, Throttle	5m	NM0666-05	<b>064973</b>	1	1	2	2	Length
		10m	NM0666-10	<b>064974</b>					
14	Circuit Breaker 10A		NJ0595-00	<b>064919</b>	2	2	4	4	Option
15	Buzzer 12V		NJ0251-00	<b>064920</b>	1	2	1	2	Option
	Buzzer 24V		NJ0515-00	<b>064921</b>					
16	Idle Switch		NJ0765-00	<b>064766</b>	1	2	1	2	Option
17	Idle Switch Extension		NM0647-08	<b>064760</b>	1	2	1	2	Option
<b>Complete sets:</b>					<b>Code 064725</b>	<b>Code 064726</b>	<b>Code 064727</b>	<b>Code 064728</b>	

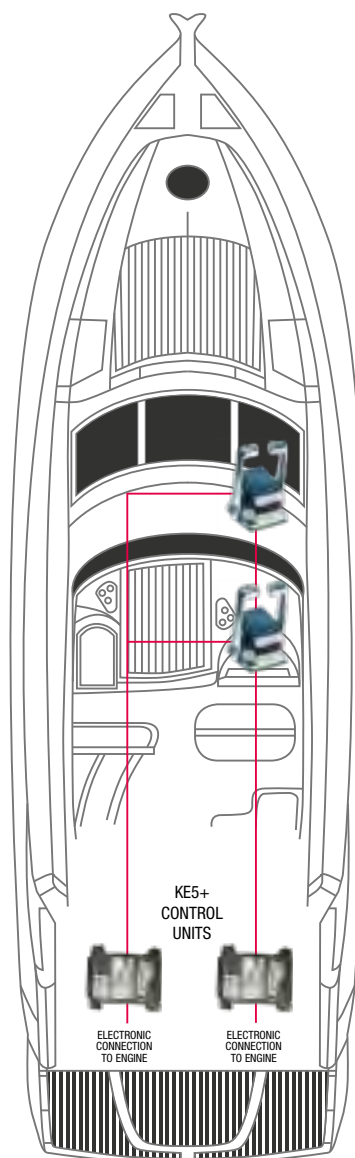
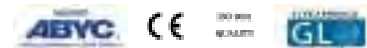

Handheld Control & Trolling System see page 89



# KE-6+ SERIES ELECTRONIC CONTROL FOR INBOARDS

For engines with:

- Electronic Throttle
- Mechanical Shift
- Optional Outboard Control Heads with or without trim



# NHK MEC

## KE-6+ Series Control System

Supply voltage range	9V ~ 32V DC
Current consumption	0.5A Stand By or less
Max. current Actuator	16A Max, 5A typical, 49N (5kgf) belasting
Throttle Output (via throttle harness)	Current: 3mA to 21mA
	Analog Voltage: 0.2V to 4.53V
	PWM: 6% to 94% Duty Cycle, 500Hz CAN: SAE J1939: 250kbits/s
Shift stroke setting	26-30-34-40mm
Throttle stroke	Max. 80mm
Temperature range	-20°C / +77°C (-4°F / 170°F)

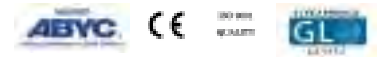

ORDER INFORMATION:				Single Engine		Dual Engine		Note	
				No. of Stations	No. of Stations	No. of Stations	No. of Stations		
No.	Description	Ref.	Code	1	2	1	2		
1	Control Head Single (SST) Inboard Style (LH) - Chrome	NM1003-00	064751	1	2	-	-		
1a	Control Head Single (SST) Inboard Style (RH) - Chrome	NM1018-00	064758	1	2	-	-	Option	
1b	Control Head Twin (SST) Inboard Style - Chrome	NM1053-00	064756	-	-	1	2		
2	Control Unit 12V/24V	NM2447-00	064882	1	1	2	2		
3	Actuator Shift/Throttle	NM0199-00	064749	1	1	2	2		
4	Harness Power Supply	5m	NM0414-28	2	2	4	4	Length!	
		10m	NM0414-33						064831
5	T-Harness (R/C-1)	NM0647-09	064761	1	1	1	1		
6	T-Harness (R/C)	NM0647-10	064762	-	1	-	1		
7	T-Harness (SINGLE)	NM0647-11	064763	1	1	-	-		
8	T-Harness (PORT)	NM0647-12	064764	-	-	1	1		
9	T-Harness (STBD)	NM0647-13	064765	-	-	1	1		
10	CANbus Harness (Other lengths available upon request. Max. 80m)	4m	NM0649-04	1	2	2	3		
		8m	NM0649-08						064778
		10m	NM0649-10						064779
		14m	NM0649-14						064782
		18m	NM0649-18						064784
		20m	NM0649-20						064785
		30m	NM0649-30						064788
11	Harness, Throttle	5m	NM0666-05	1	1	2	2	Length!	
		10m	NM0666-10						064974
12	Harness, Actuator	2m	NM0667-00	1	1	2	2		
13	Idle Switch	NJ0765-00	064766	1	2	1	2	Option	
14	Circuit Breaker 20A	NJ0514-00	064922	2	2	4	4	Option	
15	Buzzer 12V	NJ0251-00	064920	1	2	1	2	Option	
	Buzzer 24V	NJ0515-00	064921						
16	Mechanical Cable	TFXtreme	CCX633	1	1	2	2	Length!	
Complete sets:				Code 064701	Code 064702	Code 064703	Code 064704		

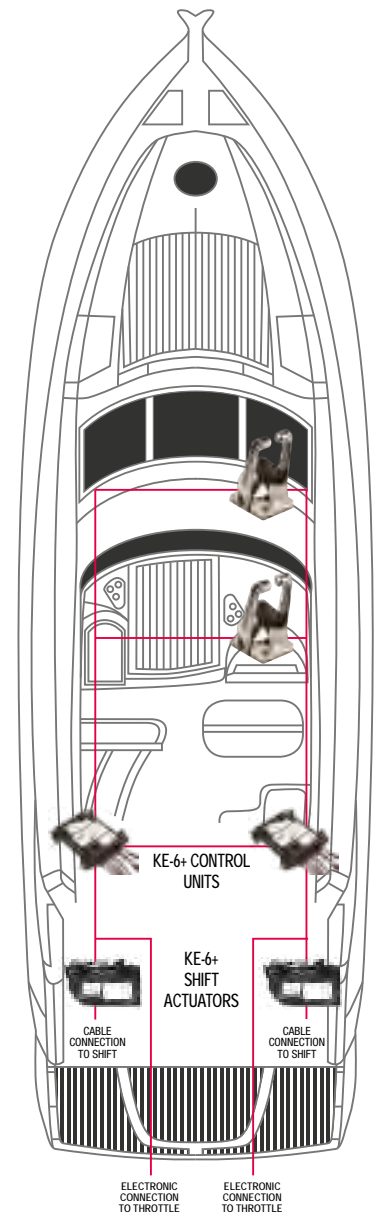

Handheld Control & Trolling System see page 89

# KE-7+ SERIES ELECTRONIC CONTROL SYSTEM FOR INBOARDS



For engines with:

- Mechanical Throttle
- Elektronic Shift
- Optional Outboard Control Heads with or without trim



KE-7+ Series Control System	
Supply voltage range	9V ~ 32V DC
Current consumption	0.5A Stand By or less
Max. current Actuator	16A Max, 5A typical, 49N (5 kgf) load
Throttle stroke	Max. 80mm
Shift output	Max. 8A contact point capacity (normally open)
Temperature range	-20°C / +77°C (-4°F / 170°F)

ORDER INFORMATION:				Single Engine		Dual Engine		Note	
				No. of Stations	No. of Stations	No. of Stations	No. of Stations		
No.	Description	Ref.	Code	1	2	1	2		
1	Control Head Single (SST) Inboard Style (LH) - Chrome	NM1003-00	064751	1	2	-	-		
1a	Control Head Single (SST) Inboard Style (RH) - Chrome	NM1018-00	064758	1	2	-	-	Option	
1b	Control Head Twin (SST) Inboard Style - Chrome	NM1053-00	064756	-	-	1	2		
2	Control Unit 12V/24V	NM2447-00	064882	1	1	2	2		
3	Actuator Shift/Throttle	NM0199-00	064749	1	1	2	2		
4	Harness Power Supply	5m	NM0414-28	064830	2	2	4	4	Length!
		10m	NM0414-33	064831					
5	T-Harness (R/C-1)	NM0647-09	064761	1	1	1	1		
6	T-Harness (R/C)	NM0647-10	064762	-	1	-	1		
7	T-Harness (SINGLE)	NM0647-11	064763	1	1	-	-		
8	T-Harness (PORT)	NM0647-12	064764	-	-	1	1		
9	T-Harness (STBD)	NM0647-13	064765	-	-	1	1		
10	CANbus Harness (Other lengths available upon request. Max. 80m)	4m	NM0649-04	064776	1	2	2	3	Please specify required harness length
		8m	NM0649-08	064778					
		10m	NM0649-10	064779					
		14m	NM0649-14	064782					
		18m	NM0649-18	064784					
		20m	NM0649-20	064785					
		30m	NM0649-30	064788					
11	Harness, Shift	5m	NM0640-05	064955	1	1	2	2	Length!
		10m	NM0640-10	064979					
12	Harness, Actuator	2m	NM0667-00	064975	1	1	2	2	
13	Idle Switch	NJ0765-00	064766	1	2	1	2	Option	
14	Circuit Breaker 20A	NJ0514-00	064922	2	2	4	4	Option	
15	Buzzer 12V	NJ0251-00	064920	1	2	1	2	Option	
	Buzzer 24V	NJ0515-00	064921						
16	Mechanical Cable	TFXtreme	CCX633	1	1	2	2	Length!	
Complete sets:				Code 064706					
				Code 064707					
				Code 064708					
				Code 064709					

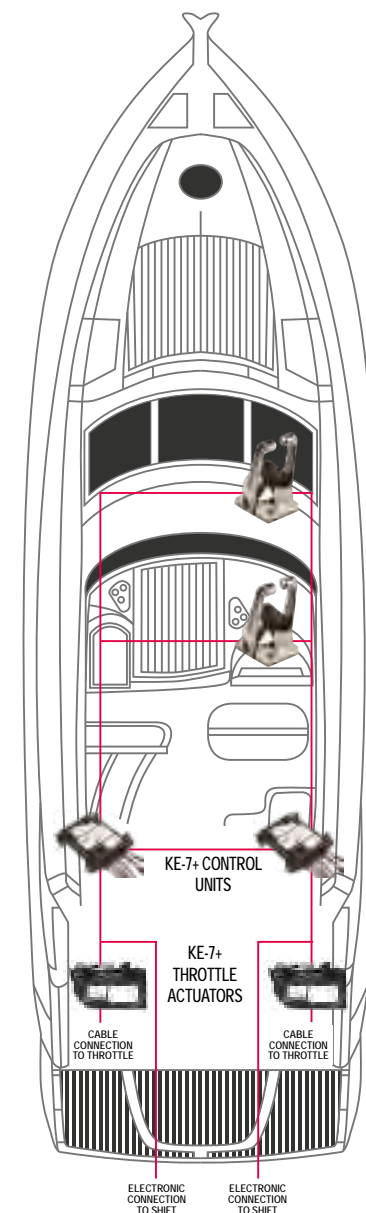
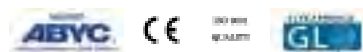

Handheld Control & Trolling System see page 89

# KE-SERIES ELECTRONIC HANDHELD CONTROL



## Handheld Control for KE4+, KE5+, KE6a & KE7

ORDER INFORMATION:				Single Engine	Dual Engine		
No.	Description	Ref.	Code				
1	Handheld Control Kit	NM0907-00	064911	1	-		
		NM0906-00	064910	-	1		
2	Cable Harness Analogue (Other lengths available upon request)	4m	NM0616-04	064841	1	2	Please specify required harness length!
		8m	NM0616-08	064843			
		10m	NM0616-10	064844			
		14m	NM0616-14	064846			
		18m	NM0616-18	064848			
		20m	NM0616-20	064849			
		30m	NM0616-30	064851			
3	Relay Kit	12V	NM0542-42	064924	1	2	
		24V	NM0542-43	064925			
	Losse houder	NM0542-041	064926				



8m Cable (attached)

# KE-SERIES TROLLING SYSTEM

## Trolling system (mechanical) for KE4+ & KE5+



ORDER INFORMATION:					Single Engine		Dual Engine		Note
No.	Description	Ref.	Code	Code	No. of Stations	No. of Stations	No. of Stations	No. of Stations	
					1	2	1	2	
1	Trolling Switch	NJ0766-00	064768		1	2	1	2	
2	CANbus Harness (Other lengths available upon request)	4m	NM0649-04	064776	1	2	1	2	Please specify required harness length!
		8m	NM0649-08	064778					
		10m	NM0649-10	064779					
		14m	NM0649-14	064782					
		18m	NM0649-18	064784					
		20m	NM0649-20	064785					
		30m	NM0649-30	064788					
3	Harness Power Supply	5m	NM0414-28	064830	2	2	4	4	Length!
		10m	NM0414-33	064831					
5	Trolling Unit	NM1481-00	064864	1	1	1	1		
6	T-Harness (Troll)	NM0647-16	064772	1	1	1	1		
7	Trolling Actuator	NM0186-00	064753	1	1	2	2		
8	Troll Harness (STBD)	NM0648-01	064773	-	-	1	1		
9	Troll Harness (PORT)	NM0648-03	064774	1	1	2	2		
10	Mechanical Cable	TFXtreme	CCX633	1	1	2	2	Length!	
<b>Complete sets:</b>					Code 064745	Code 064746	Code 064747	Code 064748	





**allpa**  
marine equipment



# Bow Thrusters

**Features:**

- Motor SE-25 1.5kW / 12V (effective)
- Weight 9.5kg
- Tunnel diameter 110mm
- Propeller Single (5 bladed)
- Transmission Direct
- Thrust 30kg
- Max. Boat size 24' / 7m

**Complete Bow Thruster**

Model XFORCE SE-25 110 12V  
With fiberglass tunnel

Item Code  
**085405/P**

**Complete kit consists of:**

(parts already included in the above kit):

	Item Code
• SE-25 12V motor	085405
• Touch pad control, with 12m Kable	085776
• Fiberglass tunnel Ø110mm, L = 0,75m	085785
• Fuse 150A	085772
• Fuse Holder	085845

**Optional system components:**

	Item Code
• Main Switch	085850
• Joystick Single (See page 92)	085779
• Aluminum tunnel Ø110mm, L=1m	085782
• Fiberglass tunnel Ø110mm, L=1m	085790
• Tooth belt set	085911



**XFORCE SE-25  
110S 12V**

**Bow Thruster**



**085776**

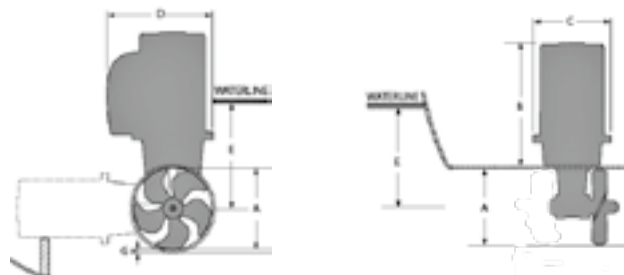

Dim (mm)	A	B	C	D	E
SE-25/110S	110	247	155	177	110

085276/  
085278



085270/  
085272

**XFORCE SE**  
  
**Stern Thruster**

**XFORCE SE-40**

**Item Code 085270** Stern thruster tunnel ø125mm

**Item Code 085276** Stern thruster Cowls

**XFORCE SE-60**

**Item Code 085272** Stern thruster tunnel ø185mm

**Item Code 085278** Stern thruster Cowls

085839

**Wireless Remote Control for Bow Thruster**

**Item Code 085838**

Wireless remote control for Bow- and stern thruster. 6-Buttons. Complete with receiver.

**Item Code 085839**

Wireless remote control for Bow thruster and windlass. 4-Buttons. Complete with receiver.



085838

	Transmitter	Receiver
Power feed	1x3V battery (Type: CR2032)	12V or 24V
Frequency (Mhz)	868MHz	868MHz
RF-power	<10mW	<10mW
Operation temp.	-10°C / +55°C	-10°C / +55°C
HxWxD (mm)	107x47x21	83x136x36
Weight	60g	275g
Voltage		8-30V
Standby power		<300mW
Load, max		4A
Operating range	30m under normal conditions	

085776



085779



085781



**Control Panel and Joysticks for Bow Thruster**

**Item Code 085776**

Standard control panel  
Dims. 71x71x07x41mm (lxwxhxd)

**Item Code 085779**

Single joystick  
Dims. 71x71x77x41mm (lxwxhxd)

**Item Code 085781**

Double joystick  
Dims. 71x121x77x41mm (lxwxhxd)

**Item Code 085811**

Cable with connector,  
12m for control panel or joystick

**Item Code 085815**

Y-Cable (p.e. for combination of standard touch pad control and single joystick)

**Features:**

- Motor SE-40 2.2kW / 12V (effective)
- Weight 10kg
- Tunnel diameter 125mm
- Propeller Single (5 Bladed)
- Transmission Direct
- Thrust 48kg
- Max. boat size 30' / 10m

**Complete Bow Thruster kit**

Model SE-40 125S 12V

- with fiberglass tunnel ø125mm, L=0.90m **085415/P**
- with steel tunnel ø125mm, L=1.00m **085415/S**

**Complete kit consists of:**

- (Parts already included in the above kit):
- SE-40 12V Motor **085415**
  - Touch pad control incl. 12m cable **085776**
  - Fiberglass tunnel ø125mm, L=0.90m **085786**  
or steel tunnel ø125mm, L=1.00m **085164**
  - Fuse 250A **085768**
  - Fuse holder **085845**

**Optional system components:**

- Joystick single **085779**
- Joystick double **085781**
- Main switch **085850**
- Fiberglass tunnel ø125mm, L=1.25m **085787**
- Fiberglass tunnel ø125mm, L=2.50m **085788**
- Propeller SE-40 **085206**

Item Code

Item Code

Item Code

**XFORCE  
SE-40 125S  
12V**

**Bow Thruster**

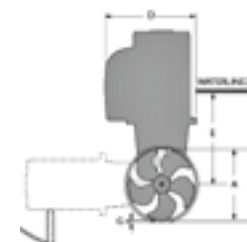

Dim. (mm)	A	B	C	D	E
SE-40/125S	125	245	190	180	125

**XFORCE**



**XFORCE**

**Features:**

- Motor SE-60 3.1kW / 12V (effective)
- Weight 16kg
- Tunnel diameter 185mm
- Propeller Single (5 Bladed)
- Transmission Direct
- Thrust 73kg
- Max. boat size 39' / 12m

**Complete Bow Thruster kit**

Model SE-60 185S 12V

- with fiberglass tunnel ø185mm, L=1.00m **085425/P**
- with steel tunnel ø185mm, L=1.00m **085425/S**

**Complete kit consists of:**

- (Parts already included in the above kit):
- SE-60 12V Motor **085425**
  - Touch pad control incl. 12m cable **085776**
  - Fiberglass Tunnelrohr ø185mm, L=1.00m **085800**  
or steel tunnel ø185mm, L=1.00m **085261**
  - Fuse 250A **085768**
  - Fuse holder **085845**

**Optional system components:**

- Joystick single **085779**
- Joystick double **085781**
- Main switch **085850**
- Fiberglass tunnel ø185mm, L=1.50m **085801**
- Fiberglass tunnel ø185mm, L=2.50m **085802**
- Propeller SE-60 **085212**

Item Code

Item Code

Item Code

**XFORCE  
SE-60 185S  
12V**

**Bow Thruster**

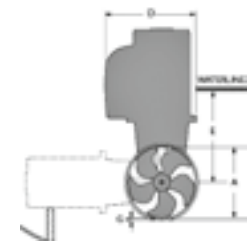

Dim. (mm)	A	B	C	D	E
SE-60/185S	185	268	208	197	150



# DOMETIC

Dometic Seastar trim tab system

SCAN ME



 **alpa**  
marine equipment

**Dynamic Trim Control Systems**





## Dometic Seastar trim tab system

### DOMETIC SEASTAR DYNAMISCH TRIM CONTROL SYSTEM

#### INTRODUCTION

The Dometic Seastar trim tab system is the only one with an intuitive dial. The controller and actuators work together to provide exceptional response and precision when it comes to steering the vessel.

#### Available for 3 types of control:

1. Standard trim tab system  
Stand-alone system
2. Optimus adaptiv trim tab system  
Integration in Optimus EPS & 360° system
3. Adaptiv trim tab system  
Integration in NMEA 2000 network through an N2K connector

#### Important features standard system:

- Intuitive dial
- Standard Electric Actuator
- Programmable Favorite
- Various sizes of stainless steel plates available in edge and standard mounting
  - o Custom-made plates on request
- Complete sets
- CE certified

#### Main features of Optimus and adaptive system:

- adaptive system
- Adaptive dial controller
- Adaptive Actuators
- Holeshoot Mode
- Show trim tab position on MFD
- Setup via Dial or CANtrak
- Various sizes of stainless steel plates available in edge and standard mounting
  - o Custom-made plates on request
- Complete sets
- CE certified



## DOMETIC SEASTAR STANDARD TRIM TAB SYSTEM

### Specifications:

Operating voltage	9-16VDC
Maximum pushing load capacity	450 kg
Impact resistance	50G
Actuator current consumption under normal load	5A
Controller	IP56
Actuator	IP66M, IP68M, IP69K
Approvals	ABYC and CE

### Unique features

- Pitch control:** Use the keys to manually control the bow up/down
- Roll control:** Turn the knob to quickly level the ship
- Favorite setting:** Press and hold the favorite button for 2 seconds to save the desired record position
- Home:** one push of the home button and the actuators retract completely
- Trailer mode:** When the engine is switched off, the actuators retract completely

We've engineered our trim tabs to deliver precise control that offers the boater an intuitive user experience on the water.

\* Wiring diagram for reference only.

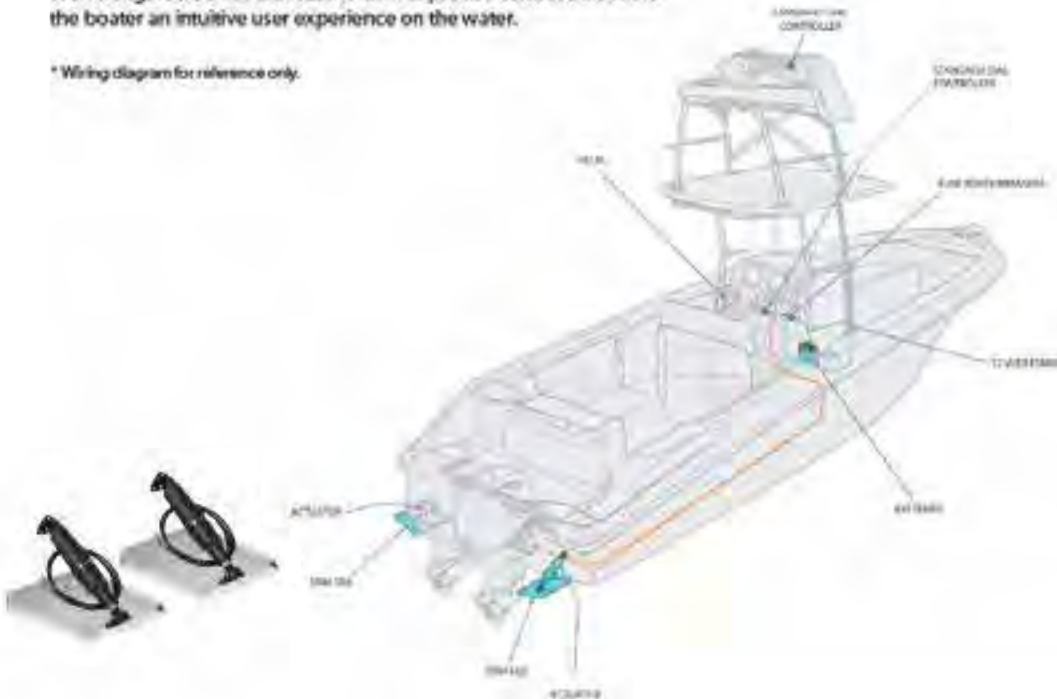

### STANDARD DIAL CONTROLLER

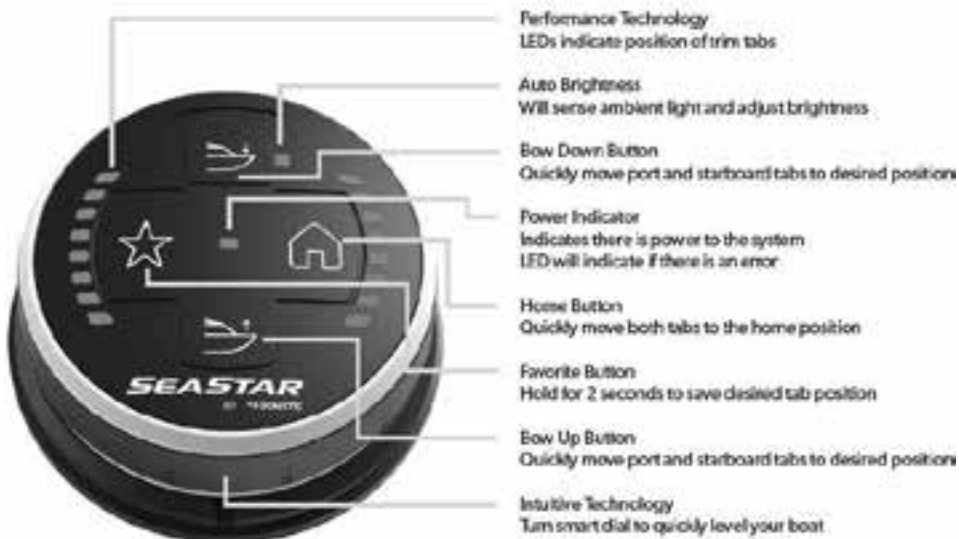

## DOMETIC SEASTAR STANDARD TRIM TAB SET

Standard trim tab sets are supplied as complete kits in a box:



Item Code	Stroke	Actuator length	Tabs size	Boat length	Standard tabs	Edge mount tabs
STT3103R	5.7 cm	29 cm	22x30 cm	16-25 ft	X	
STT3105R	5.7 cm	29 cm	30x30 cm	17-30 ft	X	
STT3131R	5.7 cm	25 cm	22x30 cm	16-25 ft	X	
STT3133R	5.7 cm	25 cm	30x30 cm	17-30 ft	X	
STT3205R	5.7 cm	29 cm	30x30 cm	17-30 ft		X
STT3207R	5.7 cm	29 cm	30x22 cm	16-25 ft		X
STT3231R	5.7 cm	25 cm	30x30 cm	17-30 ft		X
STT3233R	5.7 cm	25 cm	30x22 cm	16-25 ft		X
STT3601R	5.7 cm	29 cm	No tabs			
STT3701R	10.8 cm	33 cm	No tabs			

### Accessories and parts:

9610003175R	Kit: Standard controller, 2nd station and 9 meter harness
4471006638R	Standard controller
4471006598R	Standard controller, 2nd station
9610003176R	9 meter harness, 2nd station
9610003177R	Harness actuator power: 3.65 meter
9610003178R	Harness actuator power: 6 meter
9610003179R	Harness actuator power: 7.5 meter
9610003180R	Harness actuator power: 9 meter
4471007022R	Harness standard controller power
4471007023R	Harness standard controller, 4 pin ignition
4471006639R	Stainless steel standard tab 22 x 30 cm, incl. hardware
4471006640R	Stainless steel standard tab 30 x 30 cm, incl. hardware
4471006641R	Stainless steel edge mount tab 30 x 30 cm, incl. hardware
4471006642R	Stainless steel edge mount tab 30 x 22 cm, incl. hardware
4471006601R	29 cm actuator 5.7 cm stroke
4471006451R	25 cm actuator 5.7 cm stroke
4471006603R	33 cm actuator 10.8 cm stroke
4471004582R	Repl. kit hardware for 1 tab
4471006600R	Repl. kit connector 2 positions Deutz
4471006605R	Repl. kit hardware standard mount actuator, for 1 standard tab (29 or 33 cm)
4471006608R	Repl. kit hardware edge mount actuator, for 1 edge mount tab (29 or 33 cm)
4471006606R	Repl. kit hardware standard mount actuator, for 1 standard tab (25 or 30 cm)
4471006609R	Repl. kit hardware edge mount actuator, for 1 edge mount tab (25 or 30 cm)

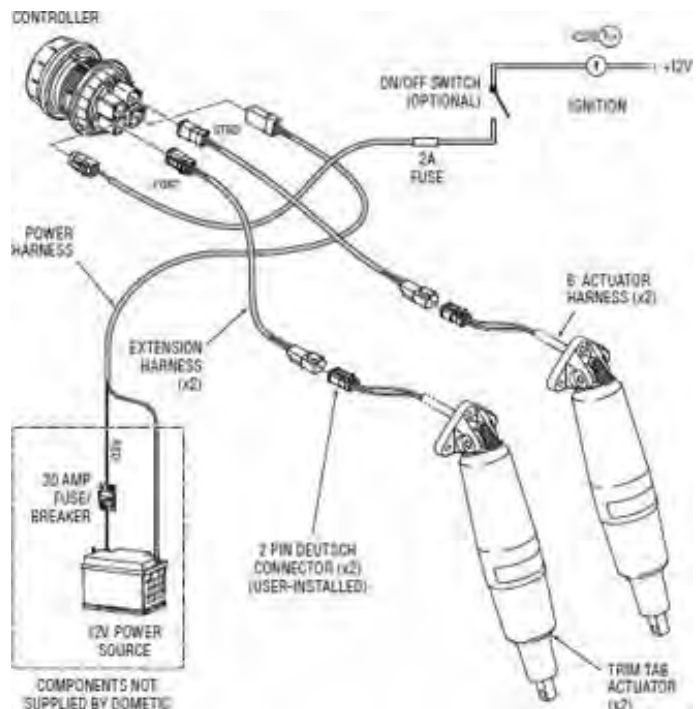

# DOMETIC

## DOMETIC SEASTAR OPTIMUS / ADAPTIVE TRIM TAB SYSTEM

**Specifications:**

Operating voltage	9-16VDC
Maximum pushing load capacity	450 kg
Impact resistance	50G
Actuator current consumption under normal load	10A
Controller	IP56
Actuator	IP66M, IP68M, IP69K
Approvals	ABYC and CE



**Unieke kenmerken:**

- Pitch control:** Use the keys to manually control the bow up/down
- Roll control:** Turn the knob to quickly level the ship
- MFD options:** When the trim tab system is connected to the public CAN network, capable chartplotters can display the trim position on the screen.
- Hole shot mode:** When Hole Shot mode is enabled, the actuators extend fully to get the boat on plane as quickly and efficiently as possible. These retract automatically as soon as the vessel reaches the pre-set rpm/speed.
- favorite setting:** Automatically learns which setting is favorite and automatically moves the tabs to this position during cruising speed
- Home:** One push of the home button and the actuators retract completely
- Trailer mode:** When the engine is switched off, the actuators retract completely
- Synchronization:** Preserves the roll correction during bow up/down operation

### Adaptive Dial Controller



- LEDs accurately indicate Trim Tab positions
- Turn dial manually to level boat as conditions change
- Each button push lowers bow in precise increments  
Hold button to lower bow quickly
- Multi-colour LEDs indicate power and status of Trim Tab system  
User adjustable LED brightness
- Quickly move tabs to fully retracted home position
- Enable automatic Hole Shot feature that helps to plane the boat faster and limit bow rise
- Automatically learns and moves your tabs to your favorite tab position during cruising
- Program your favorite position manually, and push button to quickly move the boat to the preferred position
- Each button push raises bow in precise increments  
Hold button to raise bow quickly
- Adjustable pitch and roll control sensitivity



## DOMETIC SEASTAR OPTIMUS / ADAPTIVE TRIM TAB SET

Optimus and adaptive trim tab sets are supplied as complete kits in a box:



### Optimus adaptive trim tab system

### Integration in EPS & 360° system

Item Code	Stroke	Actuator length	Tabs size	Boat length	Standard tabs	Edge mount tabs	
TT5103	5.7 cm	29 cm	22x30 cm	16-25 ft	X		
TT5105	5.7 cm	29 cm	30x30 cm	17-30 ft	X		
TT5205	5.7 cm	29 cm	30x30 cm	17-30 ft		X	
TT5207	5.7 cm	29 cm	30x22 cm	16-25 ft		X	
TT5601	5.7 cm	29 cm	No tabs				
TT5701	10.8 cm	33 cm	No tabs				
TT5131	5.7 cm	25 cm	22x30 cm	16-25 ft	X		
TT5133	5.7 cm	25 cm	30x30 cm	17-30 ft	X		
TT5231	5.7 cm	25 cm	30x30 cm	17-30 ft		X	
TT5233	5.7 cm	25 cm	30x22 cm	16-25 ft		X	

### Adaptive trim tab system

### NMEA2000 by means of an N2K connector

Item Code	Stroke	Actuator length	Tabs size	Boat length	Standard tabs	Edge mount tabs	
ATT4103	5.7 cm	29 cm	22x30 cm	16-25 ft	X		
ATT4105	5.7 cm	29 cm	30x30 cm	17-30 ft	X		
ATT4205	5.7 cm	29 cm	30x30 cm	17-30 ft		X	
ATT4207	5.7 cm	29 cm	30x22 cm	16-25 ft		X	
ATT4601	5.7 cm	29 cm	No tabs				
ATT4701	10.8 cm	33 cm	No tabs				
ATT4131	5.7 cm	25 cm	22x30 cm	16-25 ft	X		
ATT4133	5.7 cm	25 cm	30x30 cm	17-30 ft	X		
ATT4231	5.7 cm	25 cm	30x30 cm	17-30 ft		X	
ATT4233	5.7 cm	25 cm	30x22 cm	16-25 ft		X	

Example of Optimus Adaptive trim tab system connected to Optimus steering network. CAN3 will be via the SCU (electric actuator) or PCM (electro-hydraulic) of the Optimus system. Shift and gear position are available from the public N2K network which is CAN3.

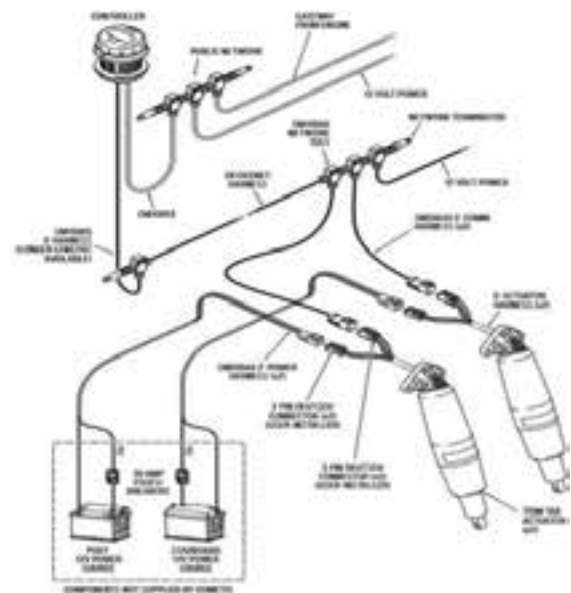
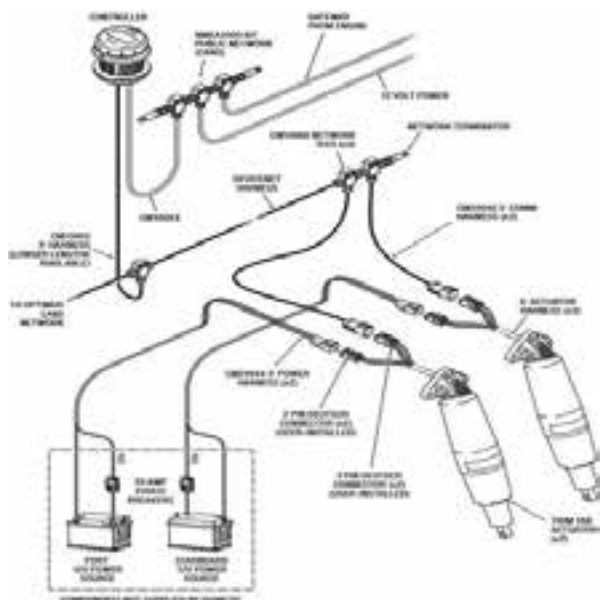

Example of Adaptive trim tab system connected to public N2K network. Shift and gear position are available from the public N2K network. Push tab position out to MFD. Private CAN network is specific to the adaptive trim tab system



Electric Trim Tab systems with powerful 12V DC motor (24V upon request) Total travel in 8 seconds. Stainless Steel (Aisi 304) trim tabs (2,8mm thickness).

**Very simple mounting: no hydraulic oil, no oil pump!**

Comes complete with all fitting materials.

Item Code clarification: e.g. 047 12 24/M  
12 = depth 12" 24 = width at the transom 24"  
(1" = 2,54cm)

Wiring length 6' (1,8m) per actuator and 20' (6m) wiring loom. Complete with watertight control panel with trim tab position indicator.

Trim tabs go automatically to "0"- position after contact switch off.

The control panel is suitable for 12V & 24V. The control unit is in the control panel. No interface box needed!

Complete Electric Trim Tab Systems with basic control panel:

**Item Code 0470909** Complete kit with tabs 09"x 09".  
For boats of 14' - 18' (4 - 5.5m)

**Item Code 0470912** Complete kit with tabs 09"x 12".  
For boats of 16' - 26' (5 - 7.5m)

**Item Code 0470918** Complete kit with tabs 09"x 18".  
For boats of 22' - 30' (7 - 9m)

**Item Code 0470924** Complete kit with tabs 09"x 24".  
For boats of 26' - 40' (8 - 12m)

**Item Code 0470930** Complete kit with tabs 09"x 30".  
For boats of 30' - 50' (9 - 15m)

**Item Code 0470936** Complete kit with tabs 09"x 36".  
For boats of 34' - 65' (10 - 20m)

**Item Code 0470102** Retrofit-kit, without tabs with cylinders en basic control panel

Spare parts for allpa electric trim tab systems.

**Item Code 0479015** Basic Control panel. Dims. 78 x 83mm(w x h).

**Item Code 0479016** Basic Fly Bridge Control panel. Dims. 78 x 83mm(w x h).

**Item Code 0470002** Control panel with trimtab indicator Black color. Dims. 100 x 85mm(w x h).

**Item Code 0479004** Standard 12V trimtab actuator 12". 8-seconds. Complete with brackets.

**Item Code 0479005** Standard 24V trimtab actuator 12". 8-seconds. Complete with brackets.

**Item Code 0479006** Standard 12V trimtab actuator 12". 4-seconds. Complete with brackets.

**Item Code 0479007** Standard 24V trimtab actuator 12". 4-seconds. Complete with brackets.

**Item Code 0470101** Trimtab kit without tabs but with actuators and black control panel with indicator and lower "Lenco" brackets.

**Item Code 0479090** Hardware kit: coach boltmounting kit for lower brackets.

**Item Code 0479091** Hardware kit with junction strip and mounting kit for upper brackets and control panel.

**Item Code 0479013** Upper bracket for actuator.

**Item Code 0479014** Lower bracket for actuator.

LIFETIME

295 mm  
stroke = 57 mm

12" (300 mm)

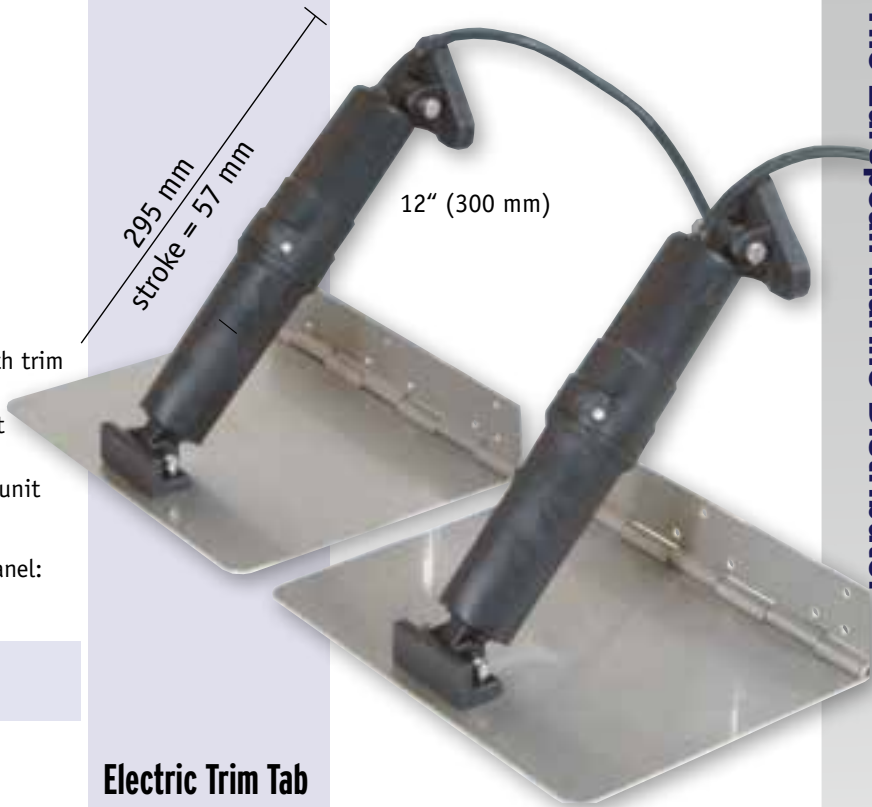

**Electric Trim Tab systems Basic without Indicator**

LIFETIME



0479015

295 mm  
stroke= 57 mm

12" (300 mm)

**Automatic Leveling Control  
1 Helm position  
(1 Control panel)**

As wind shifts, water conditions change or passengers move about, the Automatic Leveling Control (ALC) will automatically adjust your trim tabs to maintain a level boat for a more comfortable and enjoyable ride.

**The ALC automatically corrects the roll from side to side and pitch from fore to aft to enhance your boating experience and improve your fuel economy!**

Features:

- 10-30V
- Microprocessor based automatically levelling control with LED tab positions indicators
- Automatically dims LED tab position indicators in darkness and brightens in sunlight
- Controls roll and pitch automatically
- Interne GPS, no GPS antenna or network required
- Automatically adapts to varying sea conditions
- UV protected - will not deteriorate in sunlight
- Designed for planing and semi-planing hulls largen than 20'
- Actuators connect directly to (no external power module box required)
- Automatically retracts trim tabs when boat is off plane or using optional key switch connection
- Dual station (fly-bridge) operation available

**Even under acceleration the ALC will automatically adjust!**



**Electric Trim Tab system with Automatic Leveling Control  
1 Helm position  
(1 Control panel)**

<b>Item Code 0470909/ALC1</b>	Complete kit with tabs 09"x 09". For boats of 14' - 18' (4 - 5.5m).
<b>Item Code 0470912/ALC1</b>	Complete kit with tabs 09"x 12". For boats of 16' - 26' (5 -7.5m).
<b>Item Code 0470918/ALC1</b>	Complete kit with tabs 09"x 18". For boats of 22' - 30' (7 - 9m).
<b>Item Code 0470924/ALC1</b>	Complete kit with tabs 09"x 24". For boats of 26' - 40' (8 - 12m).
<b>Item Code 0470930/ALC1</b>	Complete kit with tabs 09"x 30". For boats of 30' - 50' (9 - 15m).
<b>Item Code 0470936/ALC1</b>	Complete kit with tabs 09"x 36". For boats of 34' - 65' (10 - 20m).
<b>Item Code 0471212/ALC1</b>	Complete kit with tabs 12"x 12". For boats of 17' - 30' (5 - 9m).
<b>Item Code 0471218/ALC1</b>	Complete kit with tabs 12"x 18". For boats of 26' - 36' (8 - 11m).
<b>Item Code 0471224/ALC1</b>	Complete kit with tabs 12"x 24". For boats of 30' - 44' (9 - 13m).
<b>Item Code 0471230/ALC1</b>	Complete kit with tabs 12"x 30". For boats of 34' - 54' (10 - 16m).
<b>Item Code 0471236/ALC1</b>	Complete kit with tabs 12"x 36". For boats of 38' - 69' (12 - 21m).
<b>Item Code 0471242/ALC1</b>	Complete kit with tabs 12"x 42". For boats of 42' - 79' (13 - 24m).

\*24 V: Available upon request

**Electric Trim Tab system with Automatic Leveling Control  
2 Helm positions (2 Control panels)**



<b>Item Code 0470918/ALC2</b>	Complete kit with tabs 09"x 18". For boats of 22'- 30' (7-9m).
<b>Item Code 0470924/ALC2</b>	Complete kit with tabs 09" x 24". For boats of 26'- 40' (8-12m).
<b>Item Code 0471218/ALC2</b>	Complete kit with tabs 12" x 18". For boats of 26'- 36' (8-11m).
<b>Item Code 0471224/ALC2</b>	Complete kit with tabs 12" x 24". For boats of 30'- 44' (9-13m).

**ALC- Panels for Replacement of existing standard Control Panels:**

	<b>1e ALC-Panel</b>	<b>2e ALC-Panel</b>
Single Station, Trim Tabs with <b>1</b> cylinder per Tab	<b>Code 0479020</b>	---
Single Station, Trim Tabs with <b>2</b> cylinders per Tab	<b>Code 0479023</b>	---
Twin Station, Trim Tabs with <b>1</b> cylinder per Tab	<b>Code 0479021</b>	<b>Code 0479022</b>
Twin Station, Trim Tabs with <b>2</b> Cylinders per Tab	<b>Code 0479023</b>	<b>Code 0479022</b>



Electric Trim Tab systems with powerful 12V\* DC motor, Stainless Steel (Aisi 304) trim tabs (2,8mm thickness). Very simple mounting: no hydraulic oil, no oil pump! Just electric wires and a junction block. Comes complete with all fitting materials. Wiring length 6' (1,8m) per actuator and 20' (6m) wiring loom. Complete with watertight control panel with trim tab position indicator. Trim tabs go automatically to "0" - position after contact switch off. This control panel is suitable for 12V & 24V. The control unit is in the control panel. No interface box needed!

<b>Item Code 0470909/M</b>	Complete kit with tabs 09"x 09". For boats of 14' - 18' (4 - 5.5m).
<b>Item Code 0470912/M</b>	Complete kit with tabs 09"x 12". For boats of 16' - 26' (5 - 7.5m).
<b>Item Code 0470918/M</b>	Complete kit with tabs 09"x 18". For boats of 22' - 30' (7 - 9m).
<b>Item Code 0470924/M</b>	Complete kit with tabs 09"x 24". For boats of 26' - 40' (8 - 12m).
<b>Item Code 0470930/M</b>	Complete kit with tabs 09"x 30". For boats of 30' - 50' (9 - 15m).
<b>Item Code 0470936/M</b>	Complete kit with tabs 09"x 36". For boats of 34' - 65' (10 - 20m).
<b>Item Code 0471212/M</b>	Complete kit with tabs 12"x 12". For boats of 17' - 30' (5 - 9m).
<b>Item Code 0471218/M</b>	Complete kit with tabs 12"x 18". For boats of 26' - 36' (8 - 11m).
<b>Item Code 0471224/M</b>	Complete kit with tabs 12"x 24". For boats of 30' - 44' (9 - 13m).
<b>Item Code 0471230/M</b>	Complete kit with tabs 12"x 30". For boats of 34' - 54' (10 - 16m).
<b>Item Code 0471236/M</b>	Complete kit with tabs 12"x 36". For boats of 38' - 69' (12 - 21m).
<b>Item Code 0471242/M</b>	Complete kit with tabs 12"x 42". For boats of 42' - 79' (13 - 24m).

\*24 V: Available upon request

Item Code explained: e.g. **047 12 24/M**

**12** = Trim tap depth 12"

**24** = Trim tab width at transom 24"

(1" = 2,54cm)

All kits have 1 actuator per trim tab.

Dims. control panel: (**Item Code 0470002**):

100 x 85mm (w x h).

These electric trim tab systems are also suitable as upgrade-kit for old hydraulic systems of Bennett® with 12" actuators. You just have to replace the old hydraulic actuators, control panel, hydraulic pump, hydraulic tubes and the upper actuator bracket.

The existing Bennett® trim tabs, the lower actuator bracket and bracket pin will remain.

<b>Item Code 0470002</b>	Control panel with trimtab indicator Black color. Dims. 100 x 85mm (wxh).
--------------------------	--



295 mm  
stroke = 57 mm

12" (300 mm)

## Electric Trim Tab systems with indicator



0470002

# SMART TABS™

## SX



SMART TAB  
SX105



SMART TABS  
SS



### Bigger SX - SMART TABS for boats up to 25' (7,6m)

SMART TABS utilize Nitrogen Gas filled Actuators to hold the trim plates down during low speed operation and allow the water to "automatically" push the plates up (horizontal) at higher speeds. The tabs remain under a load creating ride control like shock absorbers. No need to worry about tab position.

#### Features

- Tabs and actuators made of corrosion free molded composite materials
- Tabs have tracking ribs to improve handling at higher speeds
- Tab size 9,5" x 10" (241 x 254mm)
- Smoother and faster acceleration (great for skiing)
- 40% less Bow Rise and 35% lower on plane speed (great for tubing)
- More Top Speed and No Porpoising or Chine Walking
- Improves Handling and Smoother Ride in any water
- Improved fuel economy (up to 11% less)
- Assembly & Installation in Minutes

#### Complete sets:

- Boat length 21' - 25' => 150 - 190hp (4-Stroke)
- Boat length 21' - 25' => 175 - 220hp (2-Stroke)

**Item Code 084250** with 70Lb (32kg) actuators

- Boat length 21' - 25' => 200 - 250hp (4-Stroke)
- Boat length 21' - 25' => 220 - 250hp (2-Stroke)

**Item Code 084260** with 90Lb (41kg) actuators

Packed in carton box (no clamshell)

(1hp = 0,735kW - 1kW = 1,36hp)

#### Spare SX-cylinders (per piece):

**Item Code 084520** cylinder 20 Lb (green)

**Item Code 084530** cylinder 30 Lb (purple)

**Item Code 084540** cylinder 40 Lb (red)

**Item Code 084560** cylinder 60 Lb (blue)

**Item Code 084570** cylinder 70 Lb (yellow)

**Item Code 084580** cylinder 80 Lb (black)

**Item Code 084590** cylinder 90 Lb (white)

SMART TABS with Stainless Steel trim plates and Nitrogen Gas filled Actuators having the same features as the SX-Smart Tabs.

Tab size 12"x09" (305x229mm)

#### Complete sets:

- Boat length 12' - 14' => 40 - 50hp (4-Stroke)
- Boat length 14' - 16' => 50 - 80hp (2-Stroke)

**Item Code 084300** with 40lb (18kg) actuators

+ trimtabs 9x8"

- Boat length 15' - 17' => 60 - 100hp (4-Stroke)
- Boat length 16' - 18' => 60 - 150hp (2-Stroke)

**Item Code 084310** with 60lb (27kg) actuators

+ trimtabs 12x9"

- Boat length 18' - 22' => 150 - 240hp (2 or 4-Stroke)
- Boat length 18' - 22' => up to - V8 (inboard)

**Item Code 084320** with 80lb (36kg) actuators

+ trimtabs 12x9"

(1hp = 0,735kW - 1kW = 1,36hp)

#### Spare SX-cylinders (per piece):

**Item Code 084545** cylinder 40 Lb (red)

**Item Code 084565** cylinder 60 Lb (blue)

**Item Code 084585** cylinder 80 Lb (black)

The patented SMART TABS are a one of a kind trim and stabilizer system that automatically adjusts to the sea conditions, without the need for expensive electric or hydraulic hardware and switches. SMART TABS utilize Nitrogen Gas filled Actuators to hold the trim plates down during low speed operation and allow the water to "automatically" push the plates up (horizontal) at higher speeds. The tabs remain under a load creating ride control like shock absorbers. No need to worry about tab position.

The system constantly reacts to the water conditions, boat speed and balance providing a remarkable improvement on any boat.

**Features**

- Tabs and actuators made of corrosion free molded composite materials
- Tabs have tracking ribs to improve handling at higher speeds
- Tab size 9,5"x 10" (241 x 254mm)
- Smoother and faster acceleration (great for skiing) 40% less Bow Rise and 35% lower on plane speed (great for tubing)
- More Top Speed and No Porpoising or Chine Walking
- Improves Handling and Smoother Ride in any water
- Improved fuel economy (up to 11% less)
- Assembly & Installation in Minutes

**Complete sets:**

- Boat length 12-14' 40-50hp (4-Stroke)
- Boat length 14-16' 50-80hp (2-Stroke)

**Item Code 084200** with 40lb (18kg) actuators

- Boat length 15-17' 60-100hp (4-Stroke)
- Boat length 16-18' 60-150hp (2-Stroke)

**Item Code 084210** with 60lb (27kg) actuators

- Boat length 18-22' 150-240hp (2- & 4-Stroke)

**Item Code 084220** with 80lb (36kg) actuators

(1hp = 0,735kW - 1kW = 1,36hp)

**Spare SX-cylinders (per piece):**

**Item Code 084540** cylinder 40 Lb (red)

**Item Code 084560** cylinder 60 Lb (blue)

**Item Code 084580** cylinder 80 Lb (black)



SMART TABS SX95



**Item Code 913947**

Stainless steel 316 trim tabs with fixed bracket.

Suitable for boats up to 23'.

Angle of inclination ca. 13° positive.

**Note:**

**These trim tabs are being supplied per piece and not per set!**





**StingRay™  
Hydrofoil  
Stabilizers**



The StingRay™ Hydrofoil Stabilizer applies the laws of physics to provide the extra performance every boat needs. It's aerodynamic design creates a higher water pressure on the underside of the hydrofoil surface, which creates lift to bring the stern up and force the bow down. No other product improves performance so dramatically.

**Features:**

- On Plane in Less Time
- Fastest Hole Shot!
- Reduced Bow Rise
- Improved Top End Speed
- Eliminates Chinewalking
- Stops Porpoising
- Delivers True Stabilisation
- Saves Fuel 12 - 20%
- No-Drill™ Mounting

**StingRay™ Hydrofoil JR-XR4-1 Junior**

For Outboards from 25-75hp  
 Dims. 43,2 x 33 x 28cm (l x w x d).  
 Weight: 1,2kg  
 Slide width 167mm, H = max. 6mm  
**Item Code 084100**



**StingRay™ Hydrofoil SR-XR4-1 Senior**

For Outboards and Stern Drives from 75-300+hp  
 Dims. 58,4 x 45,7 x 30,5cm (L x w x d).  
 Weight: 2,6kg  
 Slide width 167mm, H = max. 5mm  
**Item Code 084111**



**StingRay™  
Hydrofoil  
StarFire**

**StingRay™ Hydrofoil StarFire**

The Hydrofoil for highest Top End Speed  
 For Outboards from 40-300hp  
 No-Drill™ Mounting but can be bolted  
 Dims. 54.6 x 51 x 5cm (L x w x d)  
 Weight: 1,36kg  
 Slide width 167mm, H = max. 5mm  
**Item Code 084150** black color



**NEW**

**StingRay™  
Classic PRO**

**Item Code 084160**

For outboard motors from 40 to 300hp.  
 Lift Level: 3  
 Installation through of drills (2-drill)

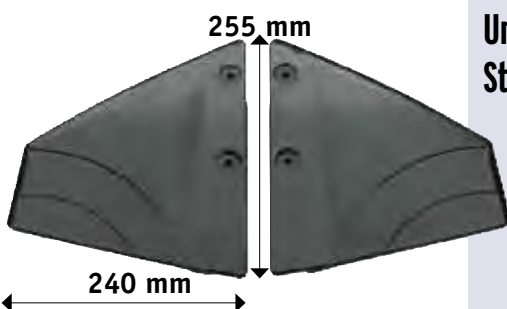
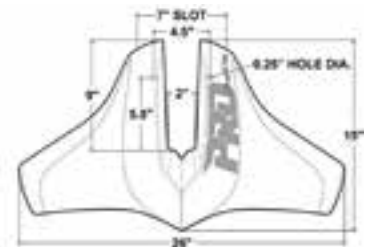

**Universal  
Stabilizer Tabs**

Universal Plastic Stabilizer Tabs for mounting on the lower unit of outboards. For faster planing while the boat stays longer in planing position with decreasing speed. Advantage: improved stability and better fuel efficiency. For outboards from 4 up to 50hp. Dims. largest width 240mm x largest length 255mm x height 37 mm, mounting holes 6-7mm and hole pitch 99 mm.  
**Item Code P0270088**

Mounting kit included.

Hi-Performance 2-stroke engine oil.  
Exceeds JASO, ISO, API & NMMA for advanced generation 2-cycle lubricants. Will not void your engine manufacturer's warranty.

**Item Code 6418-95002** Bottle 0,946 l  
**Item Code 6418-95003** Bottle 3,78 l

**„BLUE“ PREMIUM  
TC3-W3  
2-STROKE  
OUTBOARD  
ENGINE OIL**



Recommended for Mercury, Yamaha, Johnson-Evinrude, Suzuki, Honda etc. Meets and exceeds quality performance API SJ, CF-2, CH-4. Will not void your engine manufacturer's warranty.

**Item Code 6418-94202** Bottle 0,946 l

**10W-30  
4-STROKE  
MARINE  
OUTBOARD  
ENGINE OIL**



Recommended for Mercruiser, OMC and Volvo Penta. Meets and exceeds quality performance API SJ, CF-2, CH-4. Will not void your engine manufacturer's warranty.

**Item Code 6418-94002** Bottle 0,946 l

**25W-40  
4-STROKE  
MARINE  
STERN DRIVE  
ENGINE OIL**



Recommended for Volvo (VDS-3); Cummins (CES20076/77/78); Detroit Diesel (DDC93D214); Caterpillar (ECF-1 & 2). Meets Global DHD-1 specifications and the highest standards of diesel oil in the marine industry.

Increased detergency to fight soot and carbon deposits

**Item Code 6418-95532** Bottle 0,946 l  
**Item Code 6418-95533** Bottle 3,78 l

**15W-40  
API CI-4+  
DIESEL  
ENGINE OIL**



For high load operating conditions in both outboard and I/O lower units. Replaces Mercury (Quicksilver) Hi-Performance Blend, OMC (System Matched) Ultra-HPF Blend, Yamaha (Yamalube)LUB-GEARL-11-00 and Volvo Penta.

**Item Code 6418-96500** Tube 283,5 gr  
**Item Code 6418-96502** Bottle 0,946 l

**HIGH  
PERFORMANCE  
SYNTHETIC LOWER  
UNIT GEAR LUBE**



**Item Code 6418-9781** Sierra oil pump (ca. 1 l)  
**Item Code 6418-9794** GearLubeAdapterforSierraOilPump, for Nissan, Yamaha, Honda, Tohatsu.

**Item Code 6418-9795** Idem for Suzuki lower unit

**LUBE  
ACCESSORIES**



**Item Code P0218546** 4,0l (cylinder)  
**Item Code P0218547** 6,5l (cylinder)  
**Item Code P0218548** 6,0l (sphere)  
**Item Code P0218549** 2,0l (sphere)

**OIL & LIQUID  
EXTRACTION**





**Jerrycan's for  
fuel made of  
Polythene**

**Item Code 486505**

Jerrycan 5l with spout  
Dims.: 260 x 265 x 145mm (hwxwd)

**Item Code 486510**

Jerrycan 10l with spout  
Dims.: 260 x 265 x 145mm (hwxwd)



**Jerrycan / tank**

**This jerrycan can also be used as a tank.  
Made of Polythene.**

**Item Code 008029**

22l, with 2l Reserve  
405 x 330 x 240mm (hwxwd)



**Mobile  
fuel tank  
Caddy  
59l**

Mobile fuel tank made of high quality  
Polyethylene. Including double valve, hose (3 meters)  
and hand pump with holder.

**Item Code 486515**

Mobile fuel tank - Capacity: 59l

Double valve:  
no fuel in the hose during transport.  
dim. 390x390x900mm (lxwxh)

**NEW**

**Fuel Tanks made of High Density Polythene**

<b>Item Code 008010</b>	12L, with reserve. 410 x 250 x 200mm (lxwxh)
<b>Item Code 008025</b>	25L, with reserve, & outside fuel level reading. 500 x 320 x 230mm (lxwxh)
<b>Item Code 008026</b>	25L, with reserve, & mechanical fuel gauge in filler cap & fuel level outside reading 500 x 320 x 230mm (lxwxh)
<b>Item Code 000018M</b>	New filler cap with gauge (spare), L=160mm. For tank 008010.
<b>Item Code 000019M</b>	New filler cap with gauge (spare), L=200mm. For tanks 008025-26
<b>Item Code 000022</b>	Blind cap (± 2", with coarse thread)
<b>Item Code 008011</b>	Suction kit complete
<b>Item Code 482017</b>	Spare hose connection (1/4" x 8mm)

**Plastic Outboard Fuel Tanks**



**Fuel Tanks made of High Density Polythene**

<b>allpa Horizon 12L</b>	
<b>Item Code 008012</b>	12L, with reserve. 400 x 280 x 170mm (lxwxh)
<b>allpa Horizon 24L</b>	
<b>Item Code 008024</b>	24L, with reserve and outside fuel level reading. 460 x 340 x 230 (lxwxh)

**Plastic Outboard Fuel Tanks**



**40L Fuel tank with handles for easy carrying**  
**Made of Polyethene**

<b>Item Code 008040</b>	Complete with Connector Flange ( <b>Item Code 008250</b> ) suitable for mounting of a tank level sender. Dims: 500 x 400 x 280mm (lxwxh)
-------------------------	--

Connector Flange specifications: See page 110

**Fuel Tank with handles**



**Fuel tanks made of High Density Polythene.**

	Standard with pre-mounted flange & connectors
<b>Item Code 000042</b>	42L 500x350x300 (+20)mm (lxwxh)
<b>Item Code 000055</b>	55L 650x350x300 (+20)mm (lxwxh)
<b>Item Code 000070</b>	70L 800x350x300 (+20)mm (lxwxh)
<b>Item Code 008033</b>	33L 500x350x230 (+20)mm (lxwxh)
<b>Item Code 008043</b>	43L 650x350x230 (+20)mm (lxwxh)
<b>Item Code 008053</b>	53L 800x350x230 (+20)mm (lxwxh)
<b>Item Code 008080</b>	62L 660x300x410 (+25)mm (lxwxh)
<b>Item Code 008110</b>	91L 910x300x410 (+25)mm (lxwxh)
<b>Item Code 008102</b>	102L 800x400x400 (+25)mm (lxwxh)
<b>Item Code 008120</b>	120L 950x400x400 (+25)mm (lxwxh)
<b>Item Code 008140</b>	140L 1100x400x400 (+25)mm (lxwxh)

**Plastic Inboard Fuel Tanks**



<b>Item code 486590</b>	This anti-foam-overflow is connected directly to the deck entry. Excess fuel and foam are collected and returned to the fuel tank. This also is a simple fuel theft protection. Comes complete with rubber adapters to fit 38 or 50mm hose connections. The lower connection is 38 and 50mm.
-------------------------	--



**Deck entries: see page 111, 469 en 598!**

**Anti-Foam-Overflow**





21, 32 & 50l tanks (vertical)  
Ø Filling pipe 50 mm

### Stainless Steel Fuel Tanks with Flange & Connectors

return 1/4" inner thread

filling 1 1/2" outer thread (suitable for filling kit 008270)

supply 1/4" (10mm)

ventilation 3/8"(16/19mm)

blind cover tank gauge sender

Blind cap to close ventilation connection **Item code 008256**

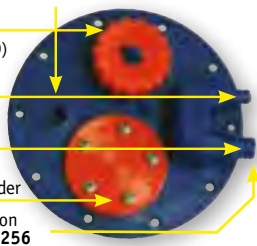

Stainless Steel Fuel Tanks with Flange & Connectors (except vertical 21, 32 & 50l Tanks), with Return- and Ventilation Connection. Complete with 1/4" Drain Plug. All Tanks have a blind cover for tank gauge sender (Teleflex/VDO mounting pattern) except 21l Tank. Material Thickness up Thru 90l Tank: 1mm. Material Thickness 120l Tank: 1,2mm. Tank of 50l and up are provided with baffles. Calculation of Tank Capacity is based on the Rectangular sizes without reckoning the radius!

<b>Item Code 020001</b>	21l horizontal	Dim. 30x35x20 (lxwxh)
<b>Item Code 020002</b>	21l vertical	Dim. 30x20x35 (lxwxh)
<b>Item Code 035001</b>	32l horizontal	Dim. 60x35x17 (lxwxh)
<b>Item Code 035002</b>	32l vertical	Dim. 60x17x35 (lxwxh)
<b>Item Code 050001</b>	50l horizontal	Dim. 70x35x20 (lxwxh)
<b>Item Code 050002</b>	50l vertical	Dim. 70x20x35 (lxwxh)
<b>Item Code 070000</b>	70l horizontal	Dim. 70x35x28 (lxwxh)
<b>Item Code 090000</b>	90l horizontal	Dim. 90x35x28 (lxwxh)
<b>Item Code 120000</b>	120l horizontal	Dim.120x35x28 (lxwxh)

<b>Item Code 008250</b>	Flange with connectors. Ø Flange: 175mm, Cut out size Ø120mm
<b>Item Code 482017</b>	Spare hose connection (1/4" x 8mm)
<b>Item Code 1004A6</b>	Spare hose connection (1/4" x 6mm)
<b>Item Code 008249</b>	Spare O-ring for flange

**This flange is already mounted as standard on most rigid stainless steel and Polythene Fuel Tanks.**



### S/S Tank fixing Braces

Set of two stainless steel fixing braces for s/s fuel tanks.

<b>Item Code 075035</b>	For 32l tanks	(L = 640mm)
<b>Item Code 075050</b>	For 21 & 50l tanks.	(L = 710mm)
<b>Item Code 075070</b>	For 70-90-120l tanks	(L = 885mm)



**NEW**

### Stainless Steel Ball Valves

Stainless Steel Ball Valves with full Flow. Suitable as shut-off valve for fuel systems.

<b>Item Code 001815A</b>	1/4"
<b>Item Code 001815B</b>	3/8"
<b>Item Code 001815C</b>	1/2"
<b>Item Code 001815G</b>	1 1/2"

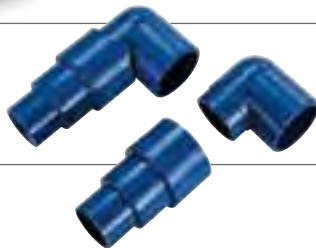

### Filler Kit for Fuel Tanks

<b>Item Code 008270</b>	Filler Kit for Fuel Tanks Fuel Hose Connection: 38-50-60mm. (straight & angled). Color Blue.
-------------------------	---



### Brass 3-Way Fuel Valve

3 Way fuel valve of moulded brass complete with flange with 2 fixing holes. Suitable to connect 2 tanks to a single feeding line.

<b>Item Code 482030</b>	Fuel hose connection 1/4" -10/12mm
<b>Item Code 482032</b>	Fuel hose connection 3/8" -12/15mm

Stroom erop:  
open  
Stroom eraf:  
dicht



310022

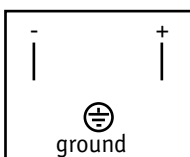

310090-93



310020

### Electric Fuel Line Valves

<b>Item Code 310020</b>	12V/12W 1/2" inner thread
<b>Item Code 310021</b>	24V/12W 1/2" inner thread
Inner flow Ø7mm. Flow capacity 80/100l/h. Made of bronze and stainless steel. With By-Pass function.	

<b>Item Code 310022</b>	12V/60W 1" inner thread
<b>Item Code 310023</b>	24V/60W 1" inner thread
Inner flow Ø25mm. Made of bronze and stainless steel. With By-Pass function.	

<b>Item Code 310090</b>	Nipple 1/2" x Ø 10mm hose
<b>Item Code 310091</b>	Nipple 1/2" x Ø 8mm copper
<b>Item Code 310092</b>	Nipple 1/2" x Ø 10mm copper
<b>Item Code 310093</b>	Nipple 1/2" x Ø 12mm copper



Deck fillers with color-coded international symbols with engraved lettering. Straight model with Ø38 mm hose connection. Build in depth is 90mm.

**Item Code 269030 Diesel with venting,**  
Ø38mm hose connection and engraved text in the stainless steel mounting rings

**Item Code 269031 Water with venting,**  
Ø38mm hose connection and engraved text in the stainless steel mounting rings

### Stainless Steel A316 Deck Entries



Deck fillers with color-coded international symbols with engraved lettering and separate key. Straight and 30° angled models with Ø38mm hose connection. Depth is 76mm.

0° Models		30° Models	
ØFlange 76mm		ØFlange 90mm	
<b>Item Code 078221</b>	<b>Water</b>	<b>Item Code 078715</b>	<b>Water</b>
<b>Item Code 078218</b>	<b>Waste</b>	<b>Item Code 078716</b>	<b>Waste</b>
<b>Item Code 078219</b>	<b>Gas</b>	<b>Item Code 078717</b>	<b>Gas</b>
<b>Item Code 078222</b>	<b>Diesel</b>	<b>Item Code 078713</b>	<b>Diesel</b>
<b>Item Code 078220</b>	<b>Fuel</b>	<b>Item Code 078718</b>	<b>Fuel</b>
<b>Item Code 078223</b>	<b>Oil</b>	<b>Item Code 078714</b>	<b>Oil</b>
<b>Item Code 078224</b>	<b>Petrol</b>	<b>Item Code 078719</b>	<b>Petrol</b>
<b>Item Code 078225</b>	Spare key HTH 30mm		
<b>Item Code 078227</b>	Spare Cap (1-1/4")		

### Stainless Steel A316 Deck Entries



**Stainless Steel Deck Entries** Housing out of plastic, the filler cap is Stainless Steel. (A)

<b>Item Code 482043</b>	<b>Fuel</b>	Ø38mm
<b>Item Code 482044</b>	<b>Fuel</b>	Ø50mm
<b>Item Code 482045</b>	<b>Water</b>	Ø38mm

**Plastic Deck Entries** Housing out of plastic with chrome plated lid. (B)

<b>Item Code 482046</b>	<b>Fuel</b>	Ø38mm
<b>Item Code 482047</b>	<b>Fuel</b>	Ø50mm
<b>Item Code 482048</b>	<b>Water</b>	Ø38mm

### Deck Entries

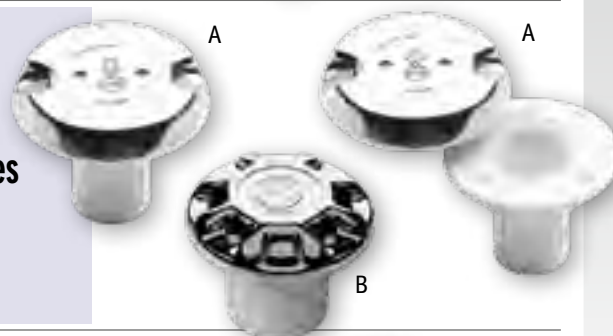

Deck Fillers with separate key  
Inner Thread 1-1/2". Flange Ø83mm. H=48mm,  
Cut-out size Ø54mm

**Item Code 001173 "Fuel"**  
**Item Code 001175 "Aqua"**

**Item Code 001174** Single key HTH 25mm

### Chromed Brass Deck Entries



Deck fillers with folding key  
Flange Ø89mm. H=81mm, Cut-out size Ø50mm

**Item Code 482040 "Diesel",** Ø50mm  
**Item Code 482041 "Water",** Ø35mm  
**Item Code 482042 "Fuel",** Ø50mm

### Chromed Brass Deck Entries



4 Pcs different Color Keys are included:  
Red/Gas, Green/Diesel, Blue/Water, Black/Waste  
6 Pcs Name Plates are included:  
Diesel, Fuel, Gas, Petrol, Waste, Water

**Item Code N2940006** Ø38mm  
**Item Code N2940007** Ø51mm

### Nylon Deck Entries with Color-Coded keys





### Tank Vents

- Item Code 001191** Ø16mm, straight
- Item Code 001190** Ø20mm, straight
- Item Code 001188/S** Ø16mm, 90° angled
- Item Code 482050** Ø16mm, flat, straight
- Item Code 482052** Ø19mm, flat, straight



Designed to be used with a Ø16mm (5/8") tank vent (001188/S). Eliminates the need to loop the vent hose  
 A=70, B=53, C=16, D=16.4, E=36 (mm)  
**Item Code 098150**

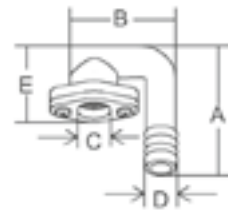

### Mechanical Tank Senders

- Item Code 008251** Tank depth 200mm (for tanks 008033/43/53)
- Item Code 008253** Tank depth 280mm (for tanks 000042/55/70)
- Item Code 008254** Tank depth 490mm (for tanks 008080/110)

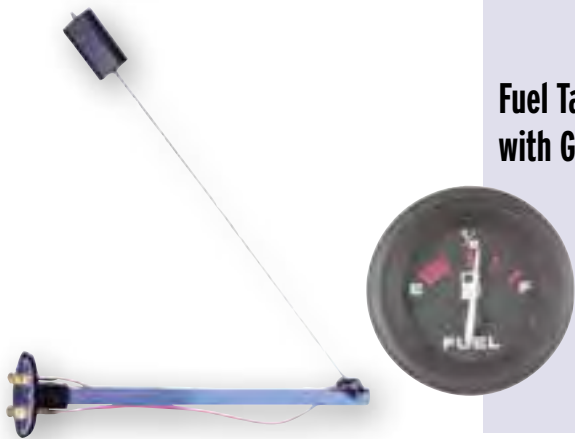

### Fuel Tank Sender with Gauge

Fuel Gauge Sender (240-33 Ohm).  
 5-Hole standard mounting pattern, arm right or left adjustable. Suitable for tanks with 4-24" (10-61 cm) depth.  
 New „VITON“ flange seal: suitable for all fuel types, worldwide.  
**Item Code 90424K** Fuel Gauge Sender  
**Item Code 57902E** Fuel Gauge

12/24V, 5-hole flange (Ø 54/70mm)  
 Fuel/Drinking Water senders have plastic floats. These floats cannot leak.  
 USA-Type for Teleflex-, Vetus-, Faria-gauges, etc. Special execution for VDO-gauges.

### Stainless Steel Tank Senders



Length	Fuel/Drinking water	
	USA 240-30 Ω	VDO 10-180 Ω
160mm	021810/T	021810/V
200mm	021811/T	021811/V
250mm	021812/T	021812/V
280mm	021813/T	021813/V
300mm	021814/T	021814/V
320mm	021815/T	021815/V
350mm	021816/T	021816/V
380mm	021817/T	021817/V
400mm	021818/T	021818/V
450mm	021819/T	021819/V
480mm	021820/T	021820/V
500mm	021821/T	021821/V



### Universal fuel in-line filters

- For hoses Ø6-8mm
- Petrol Engines:** **Item Code 000026** up to 2000 cc
  - Item Code 000028** up to 2000 cc, angled
  - Item Code 000030** up to 3500 cc
  - Diesel Engines:** **Item Code 000027** up to 2000 cc
  - Item Code 000029** up to 2000 cc, angled
  - Item Code 000031** up to 3500 cc
  - Item Code 000033** over 3500 cc

**Item Code 486410**

Fuel filter with settling, transparent bowl and bleeding screw and complete with interchangeable cartridge. For engines max 3.500cc. Max. allowed flow 50l/h. Incl. connection set Item code 486493 (2x 8mm, straight)

**Item Code 486420**

Fuel filter with settling, aluminum bowl and bleeding screw and Complete with interchangeable cartridge. For engines max 3.500cc. Max. allowed flow 50 l/h. Incl. connection set Item code 486493 (2x 8mm, straight)

**ISO 7840:2004, ISO 10088:2009**

**Item Code 486470**

Replacement Filter Element

**Item Code 486400**

1x Transparent and 1x aluminum bowl, bleeding screw and Interchangeable cartridges. For engines max 3.500cc. Max. allowed flow 50l/h. Excluding hose fittings. Incl. connection set Item code 486493 (2x 8mm, straight)

**Item Code 486401**

2x Aluminum bowl, bleeding screw and Interchangeable cartridges. For engines max 3.500cc. Max. allowed flow 50l/h. Excluding hose fittings. Incl. connection set Item code 486493 (2x 8mm, straight)

**ISO 7840:2004, ISO 10088:2009**

**allpa Fuel Filters (Diesel) with Water Separator**



For DIESEL

**allpa Double Fuel Filters (Diesel) with Water Separator**



For DIESEL

**Code 079001 Model 215R30**, Dims. 211x102 - Cap. 57l/u  
Connection M14 x 1-1/2, Service Elements R15P

**Code 079002 Model 230R30**, Dims. 229x102 - Cap. 114l/u  
Connection M14 x 1-1/2, Service Elements R20P

**Code 079003 Model 245R30**, Dims. 267x102 - Cap. 170l/u  
Connection M14 x 1-1/2, Service Elements R25P

**Spin On Filters - 200 Serie**



**Code 079085 Model 75/B3209**, Dims. 278x206 - Cap. 454l/u  
Connection M18 x 1-1/2, Service Elements S3209P

**Double Spin On filters**

**Code 079093 Model 110A**, Service Elements R11/30 micronP

**Code 079051 Model 215R**, Service Elements R15/30 micronP

**Code 079052 Model 230R**, Service Elements R20/30 micronP

**Code 079041 Model 220R**, Service Elements R24/30 micronP

**Code 079053 Model 245**, Service Elements R25/30 micronP

**Code 079046 Model 225R**, Service Elements R26/30 micronP

**Code 079056 Model 445R 645R**, Service Elements R45/30 micronP

**Code 079061 Model 460R 660R**, Service Elements R60/30 micronP

**Code 079060 Model 490R 690R**, Service Elements R90/30 micronP

**Code 079054 Model 4120R**, Service Elements R120/30 micronP

**Code 079088 Model 079085**, Service Elements S3209/30 micronP

**Code 079087 Model 079085**, Service Elements S3209P/30 micronP

**Code 079090 Model 660R**, Service Elements S3232/30 micronP

**Code 079095 Model 490R**, Service Elements S3227/30 micronP

**Code 079065 Model 660RAC**, Service Elements S3240/30 micronP

**Racor Spin On filters - Replacement elements**



**Code 079071 Model 500 Turbine**  
Service Elements 2010xM-OR/30 micronP

**Code 079073 Model 100 Turbine**  
Service Elements 2020xM-OR/30 micronP

**Code 079072 Model 900 Turbine**  
Service Elements 2040xM-OR/30 micronP

**Racor (Marine) Turbine Filters Replacement Elements**





### Sierra Fuel-Water Separator

Recommended for all 2- & 4-cycle gasoline engines\*

#### Fuel-Water Separator-Kit

- Item Code 6418-78521** Filter (21 micron) with aluminum bracket and 2x blind plug, without hose nipples
- Item Code 6418-7845** Filter element 21 micron
- Item Code 6418-7945** Filter element 10 micron

#### Fuel-Water Separator-Kit with aluminum bowl

- Item Code 6418-7951** Filter (10 micron) with aluminum bracket, aluminum bowl and 2x blind plug, without hose nipple
- Item Code 6418-7919** Filter element 10 micron
- Item Code 6418-7924** Spare aluminum bowl

#### Hose nipples

- Item Code 6418-8042** Straight Hose nipple 1/4" NPT x 1/4" (Ø6mm)
- Item Code 6418-8055** Straight Hose nipple 1/4" NPT x 5/16" (Ø8mm)
- Item Code 064302** 90° Hose nipple 1/4" x 3/8" hose (Ø10mm)
- Item Code 6418-4264** Blind plug 1/4" NPT

#### Features:

- Steel end caps on element. Heavy duty spring
- Powder coated outside, epoxy coated inside for corrosion protection
- Aluminium bracket with 1/4" NPT inlet/outlet.
- Meets OEM specifications.
- Will not separate 2 cycle oil from gasoline!
- Best flow rate of al major brands (max. 125 g.p.h./470 l/h)
- Removes 98,8% of emulsified water.
- Do not use with diesel

\*Not recommended for 1992 Gen II 4.3L/4.3LX Mercruiser with electric fuel pump and in-line fuel filter (OEM#35-805031T)



### Sierra Fuel Line Connector

- Code 064302** 90° Angled Fuel Fitting 1/4" NPT Thread 3/8" Hose Pillar
- Code 064307** 90° Angled Fuel Fitting. 3/8" NPT Thread 3/8" Hose Pillar. Replaces: OMC
- Code 064320** Fuel filter kit Inline complete with fittings 1/4", 5/16", 3/8" hose
- Code 064321** Set filter Elements with Seal rings for Code 064320
- Code 064322** Messing Fuel Tank Fitting 90° Universal connection (1/4" NPT) Replaces: Yamaha ABA-FBARB-90-DG
- Code 064323** Reduction Nipple, 1/8" x 1/4" NPT
- Code 064324** Fuel Tank Fitting 90°, 1/8" x 1/4" NPT
- Code 064325** Fuel Tank Fitting 90°, 1/4" NPT male/male



For PETROL

### Moeller fuel-water separator KIT

**Item Code 03331410**  
Filter (10 microns) with plastic bracket and transparent reservoir. Including straight hose nipple 3/8" (10mm) and 2x blind plug.

**Item Code 033336**  
Plastic Clear Reservoir



**Item Code 03331510**  
Filter cartridge 10 micron (323 l/u)











































For PETROL

### Moeller fuel-water separator KIT Bonus pack

**Item Code 03332210**  
2x Filter (10 microns) with 1x plastic bracket. Including straight hose nipple 3/8" (10mm) and 2x blind plug.



Engine	Plug motor side	Hose	Tank side plug	Tank Connector
MERCURY	≥1998  Item Code 064330 ≤1997 => Code 064309	3/8" - Ø10mm 	≥1998  Item Code 064331	≥1998  Item Code 064332
	 Item Code 064304  Item Code 064303	3/8" - Ø10mm 	 Item Code 064305	 Item Code 064303
EVINRUDE	 Item Code 064326	5/16" - Ø8mm 	 Item Code 064326	 Item Code 064301
EVINRUDE	 Item Code 064319	3/8" - Ø10mm 	 Item Code 064319	 Item Code 064301
YAMAHA & SELVA 4T	 Item Code 064308	1/4" - Ø6mm 	 Item Code 064308	 Item Code 064310
	 Item Code 064309	5/16" - Ø8mm 	 Item Code 064309	 Item Code 064310
	 Item Code 064314	3/8" - Ø8mm 	 Item Code 064314	 Item Code 064310
HONDA	 Item Code 064333	3/8" - Ø10mm 	 Item Code 064334	 Item Code 064335
SUZUKI	 Item Code 064300	5/16" - Ø8mm 	 Item Code 064300	 Item Code 064306
	 Item Code 064312	3/8" - Ø10mm 	 Item Code 064312	 Item Code 064336

Item Code 064311 Sierra Fuel Plug Adapter 1/4" NPT, Nissan/Suzuki, male

Item Code 064316 Sierra Fuel plug engine side Nissan/Tohatsu (Selva 2-stroke)  
(to be used with 064317)

Item Code 064317 Sierra Fuel Fitting Engine Side Nissan/Tohatsu (Metric Thread)

**NEW**





**Universal Fuel Line Assembly**

002007  
002008

**Single Primer Bulb**

- Item Code 002007 Primer Bulb with hose 2m.
- Item Code 002008 Primer Bulb with hose 3m.

- Item Code 006666 Primer Bulb, big size



006666



**Moeller Pump ball with hose**

**NEW**



- Item Code 03439510 Pump ball with hose 2m, 5/16"- Ø8mm

- Item Code 03338910 Pump ball with hose 2m, 3/8"- Ø10mm



**Fuel Hoses suitable for oil, petrol & diesel with approval**

**SAE J1527 B2 and ISO 8469 TYPE B Class Standard**

- Item Code 002000 8 x 13mm, Grey 25 Meters

Temperature range: -30°C to + 80°C

853852 and 855065 with CE-keur



**Fuel Hoses**

**Fuel Hoses suitable for oil, petrol & diesel**

- Item Code 002011 5 x 8mm Transparent
- Item Code 831017 10 x 17mm Black
- Item Code 831322 13 x 22mm Black
- Item Code 831623 16 x 23mm Black
- Item Code 831927 19 x 27mm Black

**Fuel Hoses suitable for oil, petrol & diesel with CE**

Standards: • SAE J 1527 • USCG A1 R1 • ISO 7840 A1 CE  
Approved: • CE • CE 0474 RINA • LLOYD'S REGISTER

- Item Code 002012 6 x 16mm – max 14bar
- Item Code 002013 8 x 17mm – max 14bar
- Item Code 002060 10 x 19mm – max 14bar
- Item Code 002014 16 x 26mm – max 10bar
- Item Code 852532 25 x 32mm – max 10bar
- Item Code 853245 32 x 44mm – max 10bar, with steel spiral inlay
- Item Code 853852 38 x 51mm – max 10bar, with steel spiral inlay
- Item Code 855065 51 x 64mm – max 10bar, with steel spiral inlay



CE

**Starter Rope**

- Item Code T0403000 Ø 3.5mm. Coil 100m

- Item Code T0405000 Ø 5.0mm. Coil 100m

<b>Item Code 002902</b>	Mariner-Mercury
<b>Item Code 002904</b>	Mariner-Suzuki *
<b>Item Code 002906</b>	Tohatsu/Mariner
<b>Item Code 002908</b>	Honda-OMC
<b>Item Code 002910</b>	OMC-Johnson/Evinrude
<b>Item Code 002912</b>	Yamaha
<b>Item Code 002914</b>	OMC *(old Mercury >1986)

### Security Stop Key's with coiled string



<b>Item Code L0610284</b>	Spiral lanyard with 7 keys for virtually all makes of outboard engines: Yamaha, Selva, Mariner, Mercury, Tohatsu, Suzuki, Johnson, Evinrude, Honda, OMC. Blister packed.
---------------------------	--

### Universal Kill Switch Key Set



<b>Item Code 078626</b>	Kill switch with coiled string. L=60mm, Ø28mm. For in- & outboards. 12/24V-5A.
<b>Item Code 078626/P</b>	Kill switch with coiled string. L=69mm, Ø28mm. For in- & outboards. 12V-10A. with float.

### Safety Switch



<b>Item Code 078626</b>	Killswitch with coiled string. L=60mm, Ø28mm. For in- & outboards. 12/24V-5A.
<b>Item Code 078626/P</b>	Kill switch with coiled string. L=69mm, Ø28mm. For in- & outboards. 12V-10A. with float.

### Safety Switch

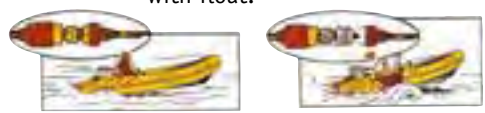

Excellent protection for Service cables & tubing for Outboard engines, against wear & tear. Complete with fittings. Colour grey with black fittings.

<b>Item Code 012100</b>	Small Model. Cut out size ø40mm, inside tube ø32mm. Tube length 800mm. Fitting comes with lock nut.
<b>Item Code 012101</b>	Large Model. Cut out size ø60mm, inside tube ø50mm. Tube length 800mm. Fitting flange to be screwed.
<b>Item Code 012103</b>	Large Model. Same as above but length is 1200mm.

### Cable & Wire Protection System

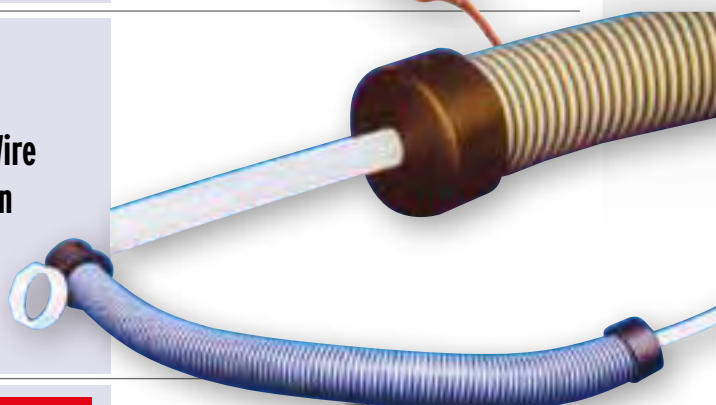

The new Shield Sternflex Hose is manufactured from polyethylene. It is resistant to abrasion, crushing and UV. This hose is primarily used as a cover for the harness and for the hoses on the bracket mounted on outboard engines. SternFlex is available in grey, white and black. Also available for our new Sternflex Hoses are matching Rigging Hose Flanges. Delivery per meter.

<b>Item Code 1161262000B</b>	Sternlex Black, Ø50mm
<b>Item Code 1161262000W</b>	Sternlex White, Ø50mm
<b>Item Code 1161262000G</b>	Sternlex Grey, Ø50mm

### Cable & Wire Protection System



<b>Item Code 64189761B</b>	UV Stabilized Black plastic flange
<b>Item Code 64189761W</b>	UV Stabilized White plastic flange
<b>Item Code 64189761G</b>	UV Stabilized Grey plastic flange



**Cable Steering Grommet of Polyurethane**

With Ring Ø105mm x Ø85mm H=68mm  
No PVC but flexible Polyurethane!

- Item Code 1643756** Black
- Item Code 1643754** White



**Small Cable Grommet**

**Item Code 001056**

With Ring, outer Ø89 mm, Cut out size Ø70 mm



**Cable Steering Grommet**

Without ring.  
Mounting hole Ø70mm.

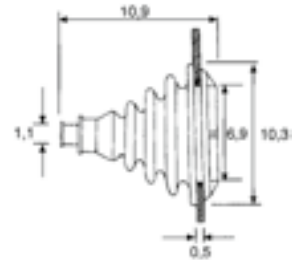

- Item Code 001066** Black
- Item Code 001066/G** Grey
- Item Code 001066/W** White



**Cable Steering Grommet & Ring**

**Item Code 001060**

Small Grommet & Ring  
Ø105mm x Ø71mm, H=70mm

**Item Code 001062**

Large Grommet & Ring  
Ø150mm x Ø118mm, H=120mm

**Item Code 001064**

Double Grommet & Ring  
Ø105mm x Ø72mm, H=52mm



**Cable Steering Grommet with Stainless Steel 316 Mounting Ring**

**Item Code 001058**

Small Grommet with Stainless Steel mounting ring  
Ø90mm x Ø58mm, H=10mm



**Fairlead Ring**

**Item Code 001055**

Diafragma model,  
Cut out size Ø59mm, outer Ø89mm



**Item Code 008580**

Protects inner side of transom only.

**Transom Protection Pad**



**Item Code N0009030**

Aluminium protection pad, protects inner side of transom only.

**Transom Protection Pad**



**Item Code 16195136**

Plastic Transom Protection Pad, white Tapered  
Dims. 450x360mm

**Transom Protection Pad**



**Item Code 16195139**

Plastic Transom Protection Pad, black Tapered  
Dims. 450x360mm

**Item Code 1645324**

Plastic Transom Protection Pad, White  
Dims. 450x360mm

**Transom Protection Pad**



**Item Code 1645327**

Plastic Transom Protection Pad, Black  
Dims. 450x360mm

**Item Code N0028040**

Flexible Protection Pad.  
For folding round transom edge, protects inside and outside.

**Transom Protection Pad**



**Item Code 004469**

For battery boxes & fuel tanks.  
Incl. strap.

**Plastic Mounting Tray**



**Item Code 004476**

For battery boxes and fuel tanks.  
Including strap. 485 x 340 x 35mm

**Rubber Mounting Tray**





### Universal Motor Flusher for Outboard's

Item Code	Model	Amm	Bmm	Cmm
078785	Square	295	16	125
078786	Round	270	16	90

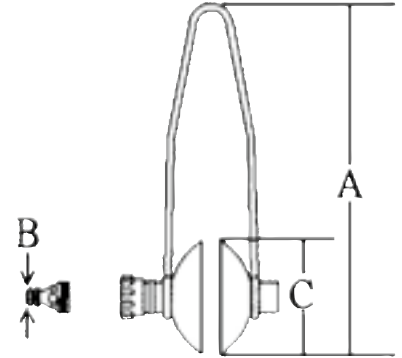

### Funnel

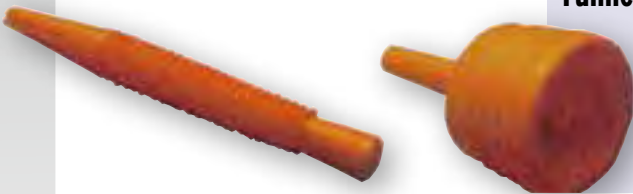

- Item Code P0000100** Funnel with filter & anti splash lip.
- Item Code P0000050** Flexible extension 340mm for funnel.



### Tiller Extension



- Item Code N4030070**  
Tiller Extension for Outboard's.  
Fixed model. Length is 700mm. With stop button.



### Tiller Extension

- Item Code N4130120**  
Tiller Extension for Outboard's. Telescopic Model.  
Length 600-1000mm. With stop button.



### Outboard Covers

- Made of strong PVC fabric
- Item Code 01100260** up to ±10hp 33 x 45 x 27cm
  - Item Code 01100380** up to ±20hp 34 x 58 x 33cm
  - Item Code 01100390** up to ±50hp 36 x 64 x 38cm

See Batteries - P 388-389

**Item Code N0180121**

Polypropylene fuel- & acid proof box with cover.  
With nylon strap. Dims. 285 x 192 x 200mm (box size).

**Battery Box  
"allpa S"**



**Item Code N0141250**

Polypropylene fuel- & acid proof box with cover.  
With nylon strap and adjustable partition.  
Dims. 410 x 200 x 200mm (box size).

**Battery Box  
"allpa M"**

**Item Code 480050**

Polypropylene fuel- & acid proof box with cover  
≥ 200 Ah  
Dims. 457 x 710 x 300mm (box size).

**XL Battery Box**



**Item Code 480055**

Polypropylene fuel- & acid proof box with cover  
Double ≥ 200 Ah  
Dims. 660 x 710 x 300mm (box size).

**XXL Battery Box**



**Item Code 480060**

Polypropylene fuel- & acid proof box with cover  
Suitable for 2 x 70Ah  
Dims. 270 x 520 x 270mm (box size).

**Battery Box**



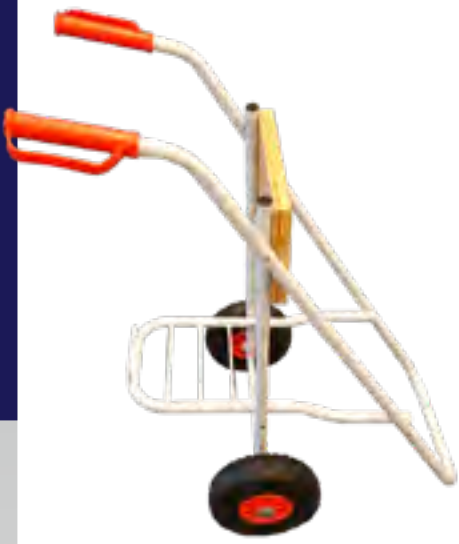

### Aluminum Trolley for Outboard Engine

**Item Code 269012**

**Weight Max. 100kg**

Extremely Light, strong and stable Trolley for Outboard Engine with aluminum frame and rubber tires. Equipped with a petrol tank holder.



### Stand for Outboard Engine

**Item Code 0090007**

Zinc steel frame, folding.  
Plank thickness 38mm.  
Height 90cm.  
Motor weight 40kg.



### Stand for Outboard Engine

**Item Code 00938008**

Zinc steel frame, folding. Plank thickness 38mm.  
Height 90cm. Motor weight max. 50kg.



### Trolley for Outboard Engine

**Item Code 00800012**

Zinc steel frame, folding. With holder for fuel tank.  
Plank thickness 38mm. Height 90cm,  
Motor weight max. 50kg.

**Item Code 069850**

For engines up to 35kg.  
Height adjustment 280mm, 5 positions.  
Plastic plank thickness 35mm. A=265mm, B=160mm,  
C=210mm, D=180mm, E=520mm, F=230mm, G=134mm  
up-185, down-235, middle-330mm

**Aluminum Motor Bracket**

**S/S Folding Motor Bracket**

**Item Code 069860 RVS**

For outboards up to 30kg.  
Height adjustment 370mm, 5 positions.  
Plank thickness 35mm.  
A=265mm, B=160mm, C=210mm, D=190mm, E=485mm,  
F=146mm, G=115mm  
up-185, down-235, middle-330mm

**Item Code 069861 Spare S/S spring**

**Item Code 069862 Locking kit**

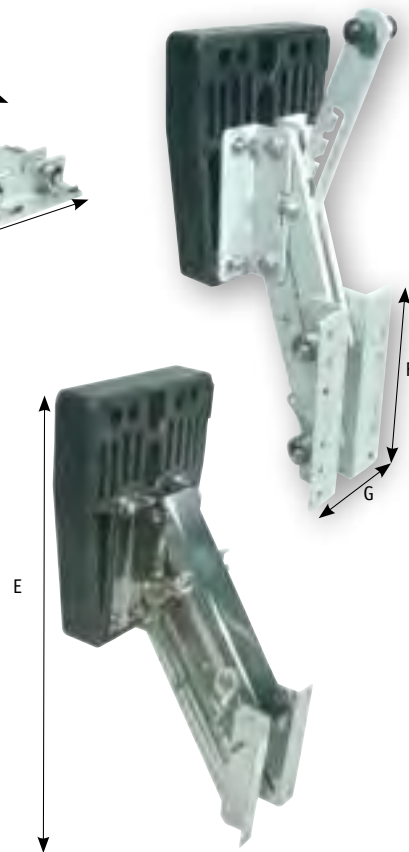
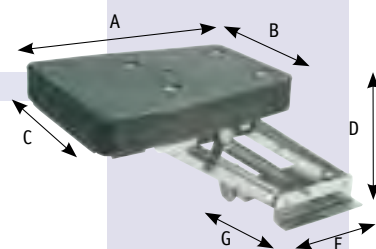

**Item Code 00500360 (Ref. 1)**

Aluminium, folding. Plank thickness 33mm. Motor weight max. 30 kg. A=220mm, B=130mm C=239mm, D=208mm

**Item Code 00500420 (Ref. 2)**

Aluminium, folding. Plank thickness 44mm. Motor weight max. 35kg. A=220mm, B=130mm C=265mm, D=208mm

**Item Code 00500480 (Ref. 3)**

Aluminium, folding. Plank thickness 54mm. Motor weight max. 40kg. For positive & negative transom. A=220mm, B=165mm C=300mm, D=258mm  
5 Positions from 7° to 35° positive or 7° to 35° negative

**Item Code 00500280 (Ref. 4)**

Mounting plate to make items 00500360 & 420 removable

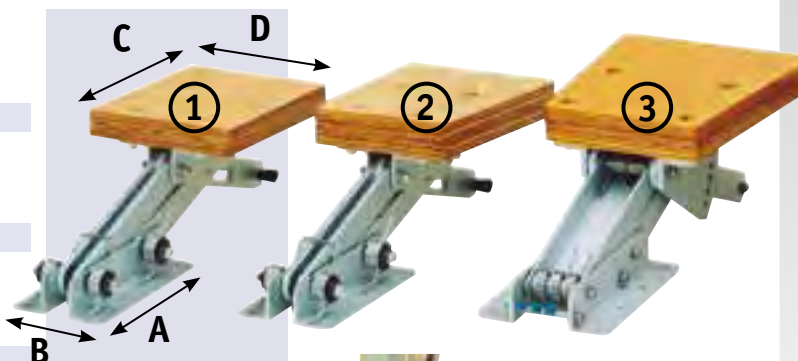

**Outboard Motor Brackets**

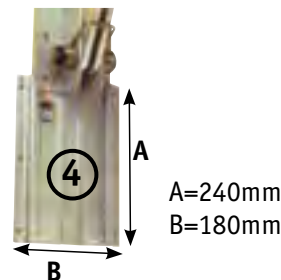

**Item Code 00570480 Strong double folding frame.**

For engines up to 50kg.  
Height adjustment 280mm, 5 positions. For positive and negative transoms. Plank thickness 35mm.  
A=220mm, B=264mm, C=300mm, D=300mm

**Aluminum Motor Bracket**

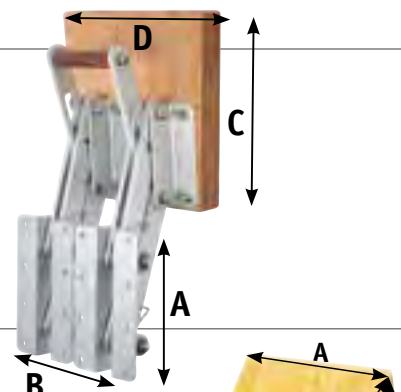

**Item Code 048239**

For outboards up to 35kg. Sliding bracket step free 380mm adjustable. For positive & negative transoms.  
Spare roller sheave: Item code 048239/R.  
A=220mm, B=295mm  
C=550mm, D=295mm  
E=235mm, F=185mm  
G=155mm

**Sliding Motor Bracket Stainless Steel**

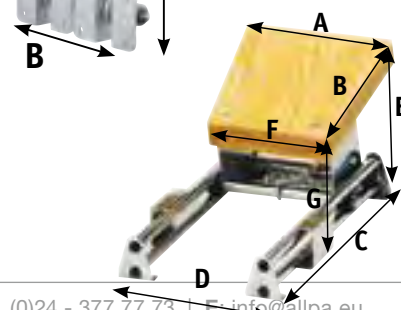



**Stainless Steel**

**Outboard Motor Lock**

**Item Code 048100**

Fits virtually every outboard. Made of high-polished stainless steel (AISI 316). Extremely secure due to solid welded ends and cylinder lock. Material thickness 2mm. Rattle free due to foam inlay's. Complete with floating key chain holder.

**Blister Packed**



**Padlock**

**Padlock made of Brass and Stainless Steel**

Item Code	Amm	Bmm	Cmm	Dmm
078890	30	22	13	5
078891	40	33	14	6
078892	50	40	16	8

**Blister packed**



**Padlock**

Item Code	A mm	B mm	C mm	D mm
024350	40	33	14	6

Brass Padlock with extra long stainless steel shackle  
Dims. 50x40mm

**Blister packed**



**Stainless Steel Padlock**

**S/S Padlock with S/S Shackle**

Item Code	Dims.
024355	30x22mm
024356	40x33mm
024357	50x40mm

**Blister packed**



**Robust lock with cable**

A robust lock and cable which can be delivered in 3 or 5 meters. Cable Ø15mm.

<b>Item Code 269065</b>	Lock with 3 meter cable
<b>Item Code 269066</b>	Lock with 5 meter cable

# SEASTAR JACKPLATE

## Manual Jackplates

### Features

The interlocking slide guides offer enhanced strength while providing smooth, bind-free travel.

The lead screw assembly sets the plate height and the Side Locks are used to hold the position.

The stainless steel lead screw is resistant to corrosion and pre-greased for smooth operation.

The maximum supported **engine weight of 265kg** (585 lbs) is capable of handling the most demanding outboard engine including the latest generation of 4-strokes.

Available in **4", 6", 8" or 10" Setbacks.**  
Max. travel: 76mm (3").

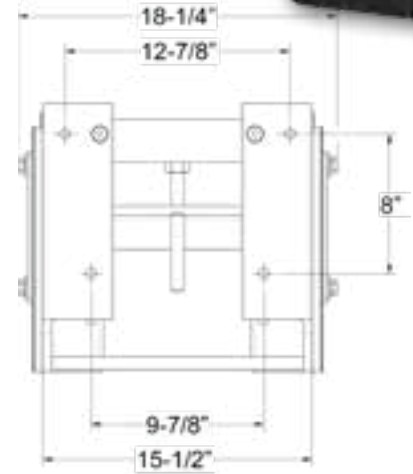
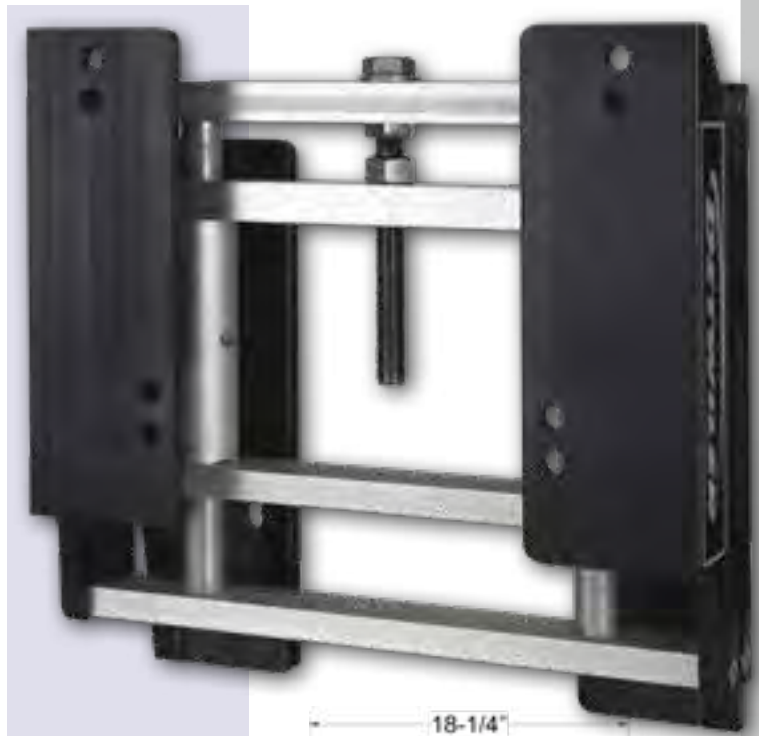

SeaStar Jackplates	Item Code
Manual Jackplate 4" Setback (15,00kg)	JP1040SS
Manual Jackplate 6" Setback (16,30kg)	JP1060SS
Manual Jackplate 8" Setback (16,30kg)	JP1080SS
Manual Jackplate 10" Setback (18,60kg)	JP1100SS

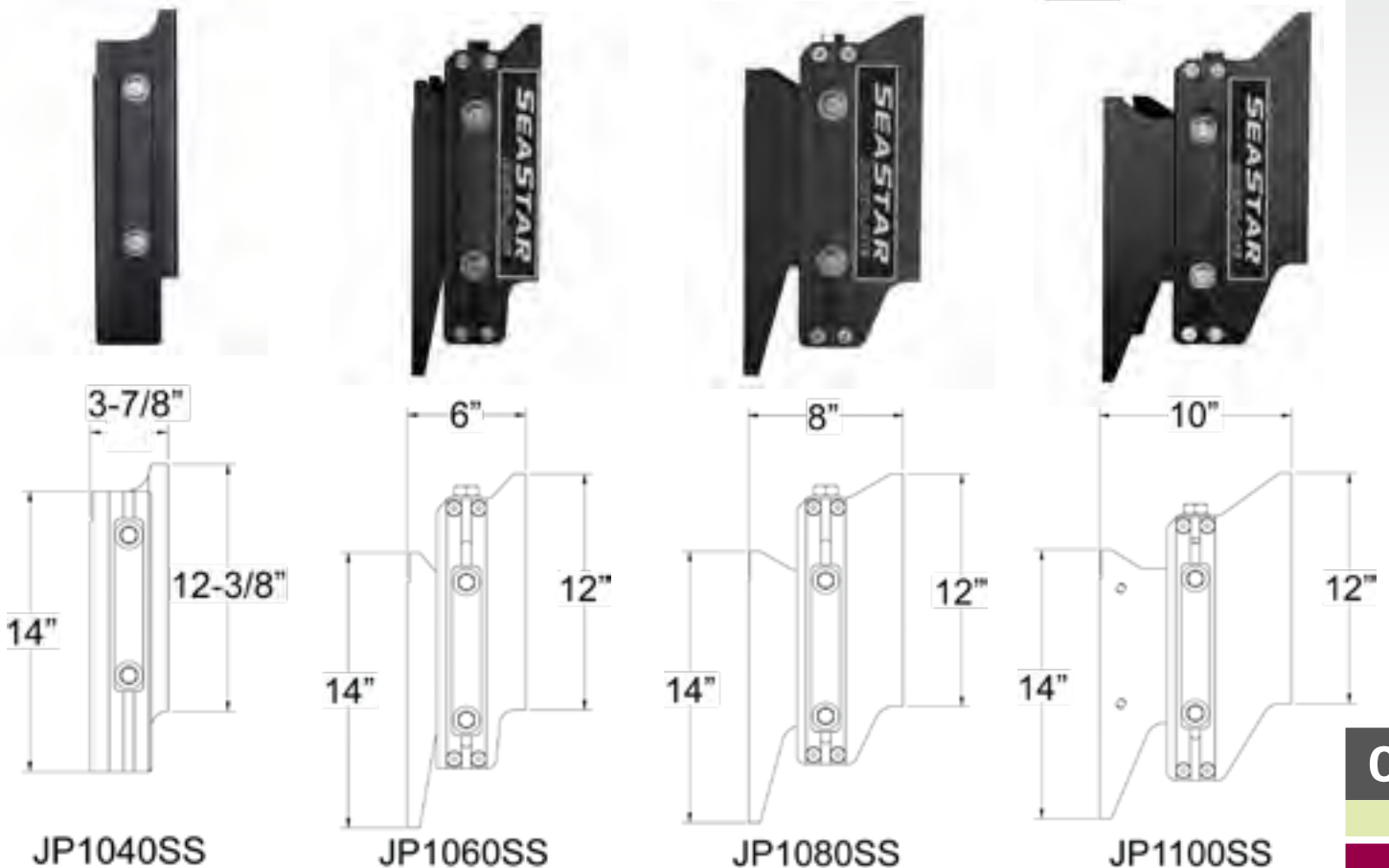

## Accessories for SeaStar hydraulic Jackplates

PT1000-2P



PT2000-2P



DK4220



DK4320



JC4010



DK6125  
DK6135  
DK6145  
DK6165

074971



DK3010



DK4020

# SEASTAR JACKPLATE

**Item Code PT1000-2P** Pro-Trim Switch, Single function

**Item Code PT2000-2P** Pro-Trim Switch, Dual function

**Item Code DK4220** SmartStick kit with gauge and harness

**Item Code DK4320** Kit with gauge and harness for 2nd helm

**Item Code JC4010** Pro-Tap Controller (Bay/Bass-Mode)

- Jackplate Synchronisation
- Jackplate Control with 2 memory presets
- Trim Control with 2 memory presets (1 engine)
- Tilt Protection (2 Engines with NMEA 2000)
- "Bump mode": 1 tap on ProTrim moves jackplate 1/4"

**Item Code DK6125** SS Bolts & washers, brass nylock nuts  
1/2"-13 UNC x 2-1/2" L (63mm)  
Set of 4 pieces

**Item Code DK6135** SS Bolts & washers, brass nylock nuts  
1/2"-13 UNC x 3-1/2" L (89mm)  
Set of 4 pieces

**Item Code DK6145** SS Bolts & washers, brass nylock nuts  
1/2"-13 UNC x 4-1/2" L (114mm)  
Set of 4 pieces

**Item Code DK6165** SS Bolts & washers, brass nylock nuts  
1/2"-13 UNC x 6-1/2" L (165mm)  
Set of 4 pieces

**Item Code 074971** SeaStar Stabilizer Clips (set 2 pc.)  
Helps keep engine centered during trailering.

**Item Code DK3010** Jackplate relays

**Item Code DK4020** Basic rocker switch  
Supplied with jackplates as standard.

**Item Code JC4110** Pro-Tap Controller & Smartstick kit  
(no gauge) (Bay/Bass-Mode)

**Item Code PTK5010** Trim harness, Pro-Tap, NMEA 2000

**Item Code PTK5020** Trim harness, Yamaha, 2-wire sender

**Item Code PTK5021** Trim harness, Yamaha, 3-wire sender

**Item Code PTK5040** Trim harness, Mercury, Smartcraft  
digital sender

**Item Code PTK5041** Trim harness, Mercury, Verado

**Item Code PTK5045** Trim harness, Mercury, V6, V8

**Item Code DK4850** Aluminum Anode Kit



# SEASTAR JACKPLATE Gen II

## Features

- The standard Jackplate is easily capable of handling up to 300HP engines with a max. weight of 283kg (625lbs).
- Utilizing high strength materials the SeaStar Xtreme Jackplates are easily capable of handling up to 400HP engines with a max. weight of 356kg (785lbs).
- **Rapid hydraulic response: 147mm travel in 8.5 seconds. Complete rigid engine support at full thrust.**
- Easily moves engine up or down at full thrust.
- Smooth operation with composite bushings. Easy wrench access to engine bolts from the side. Designed to maximize engine tilt when used with SeaStar steering cylinders.
- High visibility lift scale for quick glance operation.
- Environmentally sealed non-contact SmartStick available for precise height information.
- All hydraulic Jackplates come with basic rocker switch and harness and have an integrated circuit breaker.



Standaard Jackplates Outboards 300HP max	Item Code
Hydraulic Jackplate 4" Setback Standard (29,50kg)	JP5040R
Hydraulic Jackplate 6" Setback Standard (29,50kg)	JP5060R
Hydraulic Jackplate 8" Setback Standard (31,75kg)	JP5080R
Hydraulic Jackplate 10" Setback Standard (34,00kg)	JP5100R
Hydraulic Jackplate 12" Setback Standard (37,65kg)	JP5120R

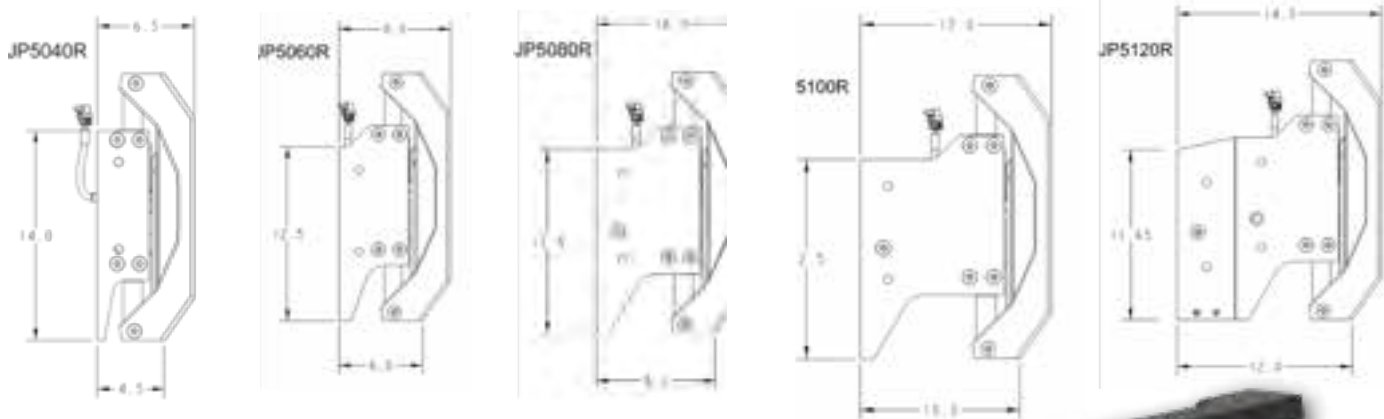

## SEASTAR™ XTREME JACKPLATE

Xtreme Jackplates Outboards 400HP max	Item Code
Hydraulic Jackplate 4" Setback Xtreme (29,50kg)	JP5040X
Hydraulic Jackplate 6" Setback Xtreme (29,50kg)	JP5060X
Hydraulic Jackplate 8" Setback Xtreme (29,50kg)	JP5080X
Hydraulic Jackplate 10" Setback Xtreme (34,00kg)	JP5100X
Hydraulic Jackplate 12" Setback Xtreme (37,65kg)	JP5120X



ALL WATER ANODES - NAVALLOY



High Performance Navalloy Anodes with Exclusive Patented Wear Indicator

10 times why Navalloy anodes?

- 1 Better protection than zinc because they generate a lower voltage
- 2 Longere life because they have more capacity for the same over all size
- 3 Suitable for any type of hull material: Aluminum, Steel and Glassfiber
- 4 Navalloy anodes will continue to work in any type of water: sea-, brackish- and freh water
- 5 Re-activated after exposure to air. No need to clean the anodes
- 6 RED SPOT wear indicator. When the RED SPOT appears than it is time to replace
- 7 Less expensive as zinc anodes
- 8 Navalloy anodes are lighter than zinc anodes
- 9 Navalloy anodes are 20 times more ECO-Friendly than Zinc anodes
- 10 Attractive packed with printed text in four languages and including fitting instructions and hardware



**Kits come with mounting material and instructions.**

Bombardier Aluminum Anode Kits					
017650A	OMC Cobra Kit				
Bombardier Aluminum Anodes					
017651A	Side Mounted		017654A	Front Gear Case	
017652A	Transom		017655A	Transom Mount	
017653A	Prop Shaft		017656A	Side Pocket Anode	
Honda Aluminum Anodes					
017657A	Trim Tab Anode		017659A	Trim Tab	
017658A	Side Pocket Anode				



Mercury Aluminum Anode Kits					
017604A	Alpha One Generation 1		017640A	Bravo 3 Retrofit	
017600A	Alpha One Generation 2		017660A	Verado 4/ Optimax	
017601A	Bravo 1		017661A	Verado 6	
017602A	Bravo 2/3		017662A	Alpha 1 Gen1 (No Power)	
017603A	Bravo 3 (2004+)				

Mercury Aluminum Anodes					
017663A	Alpha Cavitation Plate		017671A	Trim Tab Anode Flat	
017664A	Alpha Trim Cylinder		017672A	Gimbal Housing Bolt	
017665A	Alpha Bearing Carrier		017673A	Side Pocket Anode	
017666A	Trim Tab Anode		017674A	Outboard Power Trim	
017667A	Gimbal Housing Block		017675A	Manifold Anode	
017668A	Bravo Cavitation Plate		017676A	Trim Cylinder Anode	
017669A	Bravo Trim Cylinder		017645A	Prop Anode Bravo 3	
017670A	Bravo Bearing Carrier		017677A	Trim Tab Anode Flat (No Thread)	









Volvo Penta Aluminum Anode Kits					
017610A	Volvo 280		017614A	Volvo 290 Dual Prop	
017611A	Volvo 280 Dual Prop		017612A	Volvo SX	
017613A	Volvo 290		017616A	Volvo DP-S/SX-A	
Volvo Penta Aluminum Export Kits					
017678A	Volvo 280		017679A	Volvo 280	
Volvo Penta Aluminum Anodes					
017680A	Side Anode - SX, DP-X		017685A	Transom DPS-A/SX-A	
017681A	Anodic Bar		017686A	Gearhouse DPS-A/SX-A	
017682A	Anodic Bar		017687A	DPX Outdrive Cube	
017683A	Prop Ring - Duo Prop		017688A	Prop Ring -V18	
017684A	Gimbal Plate - SX		017689A	Transom Plate - SX	



Yamaha Aluminum Anode Kits					
017690A	Yamaha 200-250hp 4 Stroke		017691A	Yamaha 150 hp	
Yamaha Aluminum Anodes					
017692A	Trim Tab		017694A	Trim Tab 200-250hp 4 stroke	
017693A	Transom				
Rudder / Trim Tab Anodes					
017695A	48mm Rudder Trim Tab Double		017697A	95mm Rudder Trim Tab Double	
017696A	72mm Rudder Trim Tab Double		017698A	127mm Rudder Trim Tab Double	
Professional Hull Anodes					
017699A	0.9kg Pear Strap	 250x162mm x 46x80mm	017701A	0.4kg Disc Anode H = 33mm ø99 x ø38mm Hole ø14,3mm	 ø99mm H=33mm
017700A	1.5kg Hull Anode Pitch 200mm Hole ø12x20mm	 305x75x35			
Welding / Bolt Mount Anodes - HE Series					
017702A	140x100mm x 34x16mm Pitch 115mm Hole ø6x12mm		017705A	165mm x 88mm Pitch 187mm Hole ø9x19mm	
017703A	160x118mm x 45x25mm Pitch 137mm Hole ø6x12mm		017706A	210mm x 95mm Pitch 264mm Hole ø12x22mm	
017704A	144mm x 60mm Pitch 187mm Hole ø9x19mm				
Propeller Shaft Anodes					
017711A	Metric - 25mm		017713A	Metric - 40mm	
017712A	Metric - 30mm		017716A	Metric - 45mm	
017715A	Metric - 35mm		017714A	Metric - 50mm	





Grouper Cable L=4,5m. Do not connect to battery!			Bonding Kit Special anode for mounting in between two Stern Drives			
Z + A + M +	Code 017520 Code 017520A Code 017520M	2,69 kg 1,22 kg 0,95 kg		Z + A + M +	Code 017525 Code 017525A Code 017525M	

Mercruiser Anode Kits							
Z + A + M +	Code 017504 Code 017504A Code 017504M	Alpha 1 Gen 1 1983 - 1990		Z + A + M +	Code 017500 Code 017500A Code 017500M	Alpha 1 Gen 2 1991 - PRESENT	
Z + A + M +	Code 017501 Code 017501A Code 017501M	Bravo 1 1988 - PRESENT		Z + A + M +	Code 017502 Code 017502A Code 017502M	Bravo 2 1989 - PRESENT and Bravo 3 1989 - 2003	
Z + A + M +	Code 017503 Code 017503A Code 017503M	Bravo 3 2004 - PRESENT		<p>Z + : Zinc A + : Aluminum M+ : Magnesium</p> 			
						Navalloy: See page 134-136	









Volvo Penta Anode Kits							
Z + A + M +	Code 017510 Code 017510A Code 017510M	Volvo 280		Z + A + M +	Code 017511 Code 017511A Code 017511M	Volvo 280 Dual Prop	
Z + A + M +	Code 017513 Code 017513A Code 017513M	Volvo 290		Z + A + M +	Code 017514 Code 017514A Code 017514M	Volvo 290 Dual Prop	
Z + A + M +	Code 017515 Code 017515A Code 017515M	Volvo DPH		Z + A + M +	Code 017512 Code 017512A Code 017512M	Volvo SX	
Z + A + M +	Code 017516 Code 017516A Code 017516M	Volvo SX-A/DPS		Z + A + M +	Code 017517 Code 017517A Code 017517M	Volvo folding prop 3-blads. Motor D2-55 A,B,C,D,E,F	





Yanmar Anode Kit, divisible			Yanmar Anode Kit, non divisible			
Z + M +	Code 017518 Code 017518M	Yanmar Saildrive SD20, 30, 31 40, 50 & 60		Z + M +	Code 017140 Code 017140M	Yanmar Saildrive SD20, 30, 31 40, 50 & 60
Kits come complete with mounting material and instruction manual.				For mounting without adapter kit.		
<b>Note: S/S Adapter kit must be ordered extra: Item Code 017598</b>						







OMC/Johnson Evinrude							
Z + A + M +	<b>Code 017082</b> <b>Code 017082A</b> <b>Code 017082M</b>	<b>Waffle Bar</b> REF: 367		Z + A + M +	<b>Code 017085</b> <b>Code 017085A</b> <b>Code 017085M</b>	<b>Horseshoe</b> REF: 392462	
Z + A + M +	<b>Code 017086</b> <b>Code 017086A</b> <b>Code 017086M</b>	<b>Block</b> REF: 393023		Z + A + M +	<b>Code 017087</b> <b>Code 017087A</b> <b>Code 017087M</b>	<b>Block</b> REF: 397768	
Z + A + M +	<b>Code 017088</b> <b>Code 017088A</b> <b>Code 017088M</b>	<b>Block</b> REF: 398331		Z + A + M +	<b>Code 017090</b> <b>Code 017090A</b> <b>Code 017090M</b>	<b>Block</b> REF: 431708	
Z + A + M +	<b>Code 017094</b> <b>Code 017094A</b> <b>Code 017094M</b>	<b>Replaces: 433580Z</b> REF: 5007089		Z + A + M +	<b>Code 017065</b> <b>Code 017065A</b> <b>Code 017065M</b>	<b>Horseshoe</b> REF: 983494	
Z + A + M +	<b>Code 017067</b> <b>Code 017067A</b> <b>Code 017067M</b>	<b>Horseshoe</b> REF: 984513		Z + A + M +	<b>Code 017068</b> <b>Code 017068A</b> <b>Code 017068M</b>	<b>Block Bar</b> REF: 984547	

Honda							
Z + A + M +	<b>Code 017120</b> <b>Code 017120A</b> <b>Code 017120M</b>	<b>Small Bar 35-50HP</b> REF: 06411ZV5		Z + A + M +	<b>Code 017121</b> <b>Code 017121A</b> <b>Code 017121M</b>	<b>Large Bar 75-115HP</b> REF: 06411ZW1	
Z + A + M +	<b>Code 017122</b> <b>Code 017122A</b> <b>Code 017122M</b>	<b>Skeg</b> REF: 41107ZV500		Z + A + M +	<b>Code 017123</b> <b>Code 017123A</b> <b>Code 017123M</b>	<b>Skeg</b> REF: 41107ZW1B01	











Mercury - Mercruiser							
Z + A + M +	<b>Code 017001</b> <b>Code 017001A</b> <b>Code 017001M</b>	<b>Standaard Skeg</b> REF: 31640		Z + A + M +	<b>Code 017005</b> <b>Code 017005A</b> <b>Code 017005M</b>	<b>Cutdown Skeg</b> REF: 46399	
Z + A + M +	<b>Code 017007</b> <b>Code 017007A</b> <b>Code 017007M</b>	<b>REPLACES 76214</b> REF: 762145		Z + A + M +	<b>Code 017008</b> <b>Code 017008A</b> <b>Code 017008M</b>	<b>Bearing Carrier Anode Alpha 1</b> REF: 806105	
Z + A + M +	<b>Code 017013</b> <b>Code 017013A</b> <b>Code 017013M</b>	<b>Bearing Carrier Anode Bravo 2</b> REF: 806188		Z + A + M +	<b>Code 017006</b> <b>Code 017006A</b> <b>Code 017006M</b>	<b>Button</b> REF: 55989	
Z + A + M +	<b>Code 017009</b> <b>Code 017009A</b> <b>Code 017009M</b>	<b>Lift-Ram horseshoe Alpha 1 Gen 2</b> REF: 806189		Z + A + M +	<b>Code 017010</b> <b>Code 017010A</b> <b>Code 017010M</b>	<b>Lift-Ram horseshoe Bravo Gen 2</b> REF: 806190	
Z + A + M +	<b>Code 017021</b> <b>Code 017021A</b> <b>Code 017021M</b>	<b>Bar</b> REF: 818298		Z + A + M +	<b>Code 017011</b> <b>Code 017011A</b> <b>Code 017011M</b>	<b>Plate Alpha 1 Gen 2</b> REF: 821629	

Mercury - Mercruiser						
Z + A + M +	Code 017014 Code 017014A Code 017014M	REF: 43994 REF: 821631		Z + A + M +	Code 017012 Code 017012A Code 017012M	Bravo Plate Gen 2 REF: 821630 
Z + A + M +	Code 017023 Code 017023A Code 017023M	Wedge Gen 2 REF: 826134		Z + M +	Code 017260 Code 017260M	Prop nut assembly Alpha 1 and Bravo 1 Fine thread (3/4" NC10) 
Z + M +	Code 017265 Code 017265M	Prop nut assembly Alpha 1 and Bravo 1 		Z + M +	Code 017286 Code 017286M	Prop nut assembly Bravo 2 
Z + M +	Code 017240 Code 017240M	Prop nut assembly Bravo 3, 2003 and older 		Z + M +	Code 017245 Code 017245M	Prop nut Bravo 3, 2004 until today 

Suzuki						
Z + A + M +	Code 017130 Code 017130A Code 017130M	Standard Skeg REF: 5512587D00		Z + A + M +	Code 017131 Code 017131A Code 017131M	Cutdown Skeg REF: 551259630 
Z + A + M +	Code 017132 Code 017132A Code 017132M	Small block REF: 5532095310		Z + A + M +	Code 017133 Code 017133A Code 017133M	REF: 3C7602181 REF: 5532194900 

Volvo Penta						
Z + A + M +	Code 017043 Code 017043A Code 017043M	Large ring REF: 875815-3		Z + A + M +	Code 017045 Code 017045A Code 017045M	Volvo Sail Drive REF: 358407 
Z + A + M +	Code 017046 Code 017046A Code 017046M	Transom Shield for SXA/DPS REF: 3841427		Z + A + M +	Code 017030 Code 017030A Code 017030M	Gimbal Plate for SX drive REF: 3854130 
Z + A + M +	Code 017031 Code 017031A Code 017031M	Transom Plate for SX drive REF: 3855411		Z + A + M +	Code 017047 Code 017047A Code 017047M	Upper gear case for SXA/DPS REF: 3883728 
Z + A + M +	Code 017033 Code 017033A Code 017033M	Dogbone REF: 832598		Z + A + M +	Code 017035 Code 017035A Code 017035M	Saildrive ring REF: 851983 
Z + A + M +	Code 017036 Code 017036A Code 017036M	Bar REF: 852835		Z + A + M +	Code 017038 Code 017038A Code 017038M	Triangle voor 290, 290SP, SX and DP-X REF: 872793 
Z + A + M +	Code 017048 Code 017048A Code 017048M	HP transom shield for SXA/DP-X REF: 873395		Z + A + M +	Code 017037 Code 017037A Code 017037M	Bar DP-X drive REF: 872139 
Z + A + M +	Code 017042 Code 017042A Code 017042M	Saildrive ring REF: 875812		Z + A + M +	Code 017044 Code 017044A Code 017044M	Duo prop ring REF: 875821 



Yamaha							
Z + A + M +	<b>Code 017100</b> <b>Code 017100A</b> <b>Code 017100M</b>	<b>Cutdown skeg</b> REF: 6644537101		Z + A + M +	<b>Code 017101</b> <b>Code 017101A</b> <b>Code 017101M</b>	<b>Button</b> REF: 6884525101	
Z + A + M +	<b>Code 017102</b> <b>Code 017102A</b> <b>Code 017102M</b>	<b>Skeg</b> REF: 6884537102		Z + A + M +	<b>Code 017103</b> <b>Code 017103A</b> <b>Code 017103M</b>	<b>Small Block</b> REF: 6E04525111 650 x 250 x 25mm (lxbxh), øm5	
Z + A + M +	<b>Code 017110</b> <b>Code 017110A</b> <b>Code 017110M</b>	<b>Skeg</b> REF: 6K14537102		Z + A + M +	<b>Code 017111</b> <b>Code 017111A</b> <b>Code 017111M</b>	<b>Trib Tab</b> REF: 69L4537100	
Z + A + M +	<b>Code 017104</b> <b>Code 017104A</b> <b>Code 017104M</b>	<b>Small block</b> REF: 6E54525100		Z + A + M +	<b>Code 017105</b> <b>Code 017105A</b> <b>Code 017105M</b>	<b>Skeg</b> REF: 6E54537101	
Z + A + M +	<b>Code 017109</b> <b>Code 017109A</b> <b>Code 017109M</b>	<b>Skeg</b> REF: 6K14537100		Z + A + M +	<b>Code 017106</b> <b>Code 017106A</b> <b>Code 017106M</b>	<b>Handle Bar</b> REF: 6G54525101	
Z + A + M +	<b>Code 017107</b> <b>Code 017107A</b> <b>Code 017107M</b>	<b>Bar</b> REF: 6H14525102 203 x 36mm (lxb), steek 102mm					

## Bellows

### Volvo-penta

<b>Code 500505</b>	OE 876631-3, OE 875829-4, OE 875848-4	<b>A</b>
<b>Code 500505FL</b>	OE 875828-6, OE 876633-9	<b>B</b>
<b>Code 500510K</b>	OE 876294-0, OE 875256-0	<b>C</b>
<b>Code 500514K</b>	OE 3854127, OE 384148	<b>D</b>
<b>Code 500528K</b>	OE 3850426	<b>E</b>
<b>Code 500530</b>	OE 858955	<b>F</b>
<b>Code 500531</b>	OE 860396, OE 3858139	<b>G</b>
<b>Code 500533K</b>	OE 3860384, OE 3858139	<b>H</b>
<b>Code 500534</b>	OE 3852696	<b>I</b>

### Mercuriser

<b>Code 500507</b>	OE 32-44348T	<b>1</b>
<b>Code 500508</b>	OE 32-14358T	<b>2</b>
<b>Code 500509K</b>	OE 86840A3	<b>3</b>
<b>Code 500511</b>	OE 32-90949T	<b>4</b>
<b>Code 500512K</b>	OE 18654A1	<b>5</b>
<b>Code 500513K</b>	OE 74639, OE 74639A2	<b>6</b>
<b>Code 500515K</b>	OE 816431A1	<b>7</b>
<b>Code 500516K</b>	OE 60932A4	<b>8</b>
<b>Code 500520K</b>	OE 78458A1	<b>9</b>
<b>Code 500522K</b>	OE 36223A2	<b>10</b>
<b>Code 500523</b>	OE 70981A3	<b>11</b>
<b>Code 500524</b>	OE 53114A1	<b>12</b>
<b>Code 500532</b>	OE 32-807458T	<b>13</b>

### OMC Sterndrive/Cobra

<b>Code 500506</b>	OE 911826
<b>Code 500514K</b>	OE 987467, OE 983973
<b>Code 500521</b>	OE 912374-1
<b>Code 500527K</b>	OE 914036





**Zinc & Aluminum Hull Anodes for Welding**

Zinc Hull Anodes for Welding

Item Code	Dimensions (a x b x c x h)	Gewicht	Materiaal
077405	100x60x190x20	0,60 kg	Zinc
077415	110x60x190x28	1,00 kg	Zinc
077425	180x65x300x30	1,80 kg	Zinc
077435	200x70x300x25	2,20 kg	Zinc
077445	150x90x250x40	3,00 kg	Zinc

Aluminum Hull Anodes for Welding

Item Code	Dimensions (a x b x c x h)	Weight	Material
077005	110x60x190x28	0,60 kg	Aluminium
077015	180x65x300x30	0,90 kg	Aluminium
077025	200x95x300x25	1,40 kg	Aluminium
077035	290x80x390x40	2,20 kg	Aluminium

Earlier Series:

Item Code	Dimensions (a x b x c x h)	Weight	Material
077400	203x120x40x25	0,55 kg	Zinc
077410	260x178x60x30	1,13 kg	Zinc
077420	340x231x76x35	2,42 kg	Zinc
077000	203x120x40x25	0,25 kg	Aluminium
077010	260x178x60x30	0,55 kg	Aluminium
077020	340x231x76x35	1,00 kg	Aluminium



**Magnesium Hull Anodes for Welding**

Item Code	Dimensions (a x b x c x h)	Weight	Material
077935	110x60x190x28	0,30 kg	Magnesium
077936	180x65x300x30	0,75 kg	Magnesium
077937	290x80x390x40	1,30 kg	Magnesium

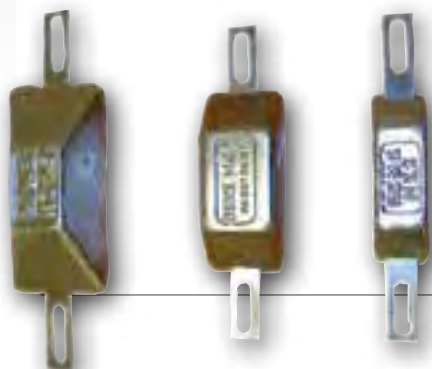

**Zinc Hull Anodes type HZ**

Item Code	Dimensions	Weight	Material
077450	165x30	0,2 kg	Zinc
077451	165x40	0,5 kg	Zinc
077452	200x60	1,0 kg	Zinc



**Propeller Anode**

Ø Shaft mm	Zinc	Aluminium
20	Code 465120	Code 017820A
25	Code 465125	Code 017825A
30	Code 465130	Code 017830A
35	Code 465135	Code 017835A
40	Code 465140	Code 017840A
45	Code 465145	Code 017845A
50	Code 465150	Code 017850A
55	Code 465155	Code 017855A
60	Code 465160	Code 017860A

Only the anode

Ø Shaft	Zinc	Aluminum	Magnesium
20mm	Code 077520	Code 077220	Code 077940
22mm	Code 077522	Code 077222	Code 077941
25mm	Code 077525	Code 077225	Code 077942
30mm	Code 077530	Code 077230	Code 077943
32mm	Code 077532	Code 077232	Code 077944
35mm	Code 077535	Code 077235	Code 077945
38mm	Code 077538	Code 077238	Code 077949
40mm	Code 077540	Code 077240	Code 077946
45mm	Code 077545	Code 077245	Code 077947
50mm	Code 077550	Code 077250	Code 077948
55mm	Code 077555	Code 077255	
60mm	Code 077560	Code 077260	

### Propeller Shaft Anodes Spherical



Ø Shaft	Zinc	Aluminum	Magnesium
20mm	Code 077619	Code 077319	
25mm	Code 077625	Code 077325	Code 077950
30mm	Code 077630	Code 077330	Code 077951
35mm	Code 077635	Code 077335	Code 077952
38mm	Code 077638		
40mm	Code 077640	Code 077340	Code 077953
45mm	Code 077645	Code 077345	
50mm	Code 077650	Code 077350	
55mm	Code 077655		
60mm	Code 077660		

### Propeller Shaft Anodes Ring shaped



Ø Shaft	Zinc	Aluminum	Magnesium
50	Code 077899		
70	Code 077900		Code 077960
90	Code 077901	Code 077190	Code 077961
110	Code 077903	Code 077191	
125	Code 077902		

### Rudder Anodes Single



Zinc	Aluminum	Magnesium
Code 077905 (Ø70mm)	Code 017696A (Ø72mm)	
Code 077906 (Ø90mm)	Code 017697A (Ø95mm)	
Code 077907 (Ø125mm)	Code 017698A (Ø127mm)	Code 077962 (Ø130mm)

### Rudder Anodes Double



### Anodes Bolt Mounting

Dims. l x w x h x pitch	Zinc	Aluminum	Magnesium
Model A 150x60x25x80	Code 077860	Code 077810	Code 077970
Model A 250x65x28x140	Code 077861	Code 077811	Code 077971
Model A 350x70x35x200	Code 077862	Code 077812	Code 077972
Model B 200x65x35	Code 077865	Code 077815	Code 077975
Model B 320x65x35x160	Code 077866	Code 077816	Code 077976
Model C Ø 80mm	Code 077920	Code 077800	Code 077980



## Impellers 1



allpa impellers with code 'G', 'GT' and 'GX' are including gasket!  
G: Gasket | T: Cap | X: Screw | C: Key. **Made in the EU**



See from p. 494, 498-501 for Johnson Impellers

	Item Code	Note	Ref.	No. of Vanes	Dimensions		
					A	B	C
	500100	GX	Jabsco: 4528-0001, Vetus: IMP00501, Volvo: 803729, 833550, JP-806B 358494, 876554-7, 21972908. Yanmar: 104211-42070, 104211-42071	6	9,54	39,6	18,94
	500101	GX	Jabsco: 653-0001, Yanmar: 128990-42200, Nanni: 434014, Westerbeke: 34440, JP-810B	6	12,17	50,8	22,1
	500131	X	Jabsco: 18777-0001, Solé 22.32111008R	6	10	39,6	19,2
	500146	X	Jabsco: 18653-0001, Vetus: IMP00701, JMP: 7070-1, DJ Pump: 08-39-0601	10	12,17	51,8	22
	500134	X	Eska	8	11,2	25,9	38,5
	500116	GX	Jabsco: 673-0001, Vetus: IMP00101, Volvo: 3580066, 3586497, 875808-8, 3593659, 21951344, 804696, 876690, 897055, JP-1026B	6	12,6	50,8	22,1
	500121	GX	Jabsco: 22405-0001, Vetus: IMP00601, Volvo: 875583-7, 3586496, 21951342, 833995, Nanni: 434013, JP-808B, Ruggerini 03.43917	6	12	39,6	19,2
	500156	GX	Jabsco: 18673-0001, JMP: 7071-01, Perkins: 24880194	10	12,66	51,8	22

## Impellers 2



allpa impellers with code 'G', 'GT' and 'GX' are including gasket!  
G: Gasket | T: Cap | X: Screw | C: Key. **Made in the EU**



	Item Code	Note	Ref.	No. of Vanes	Dimensions		
					A	B	C
	500107	GT	Jabsco: 1210-0001, 3085-0001, Vetus: IMP00201, Volvo: 3862567, 3855546, 3856039, 21951348, 875811-2, Yanmar: 129470-42530, 129470-42532, 129670-42531, 127610-42270, JP-1027B	12	14,29	57	31,6
	500114	T	Jabsco: 17937-0001, Vetus: IMP00301, Volvo: 3588475, Yanmar: 127610-42200, Sherwood: 18200K, Cummins: 879194186, Perkins: 0460024, 24880031	10	14,29	65	50,1
	500189	GT	Volvo: 21213660, 3862567, 21951348	12	14,29	57	32,05
	500106	GT	Jabsco: 920-0001, Vetus: IMP00301, Volvo: 3841697, 877061-2, 875593-6, 3841697, 21951356, Yanmar: 127610-42200, JP-1028B	8	14,29	65	50,2
	500155		Jabsco: 11979-0001, DJ Pump: 08-40-0801	8	14,29	58,65	36,65
	500161		Jabsco: 31130-0061, Yanmar: 119593-42200, 119593-42202, DJ Pump: 09-42-1001	10	14,29	65	68,2
	500124		Jabsco: 13554-0001, Yamaha: 6TA-12457-00, Yanmar: 119773-42600-01, JP-812B	12	14,29	57	48,2
	500177	GT	Jabsco: 17018-0001, 17018-0001B, Volvo: 3588474, 3593573, 3583602, 3819486, 3593573, 3588476, 3583602, 3819486, Caterpillar: 3N5895	8	16	65,2	75,65
	500178	G	Volvo: 3584350, 3588914, 3842786, 21213664, 21951352, 3593660, 2121794	12	14,29	57	48,2
	500162	G	Volvo: 876771, 21951358, 3887761, Yanmar: 119574-42550, 119574-42552, DJ pump: 09-44-1201	12	22,5	65,8	80
	500104	GT	Jabsco: 22120-0001	12	14,29	57	50,2



allpa impellers with code 'G', 'GT' and 'GX' are including gasket!  
G: Gasket | T: Cap | X: Screw | C: Key. **Made in the EU**



## Impellers 2

See from p. 494, 498-501 for Johnson Impellers

Item Code	Note	Ref.	No. of Vanes	Dimensions			
				A	B	C	
500135	T	Jabsco: 17935-0001, Volvo: 877066, 21951362, Caterpillar: 5N9360, Detroit diesel: 8924838	12	22,5	5	63,1	
500150		Jabsco: 13554-6001, DJ pump: 09-105-1201	12	14,29	57,15	48,25	
500115	T	Jabsco: 6760-0001, DJ pump: 086-0901, JMP: 8200-01	9	22,5	95	88,5	
500133	G	Jabsco: 18777-0001, Volvo: 834794, 876120	10	14,29	57,18	50,25	
500145	GT	Jabsco: 17936-0001, 21676-0001, Vetus: IMP00801, Volvo: 875814, 875697, 21951364, Caterpillar: 4L8470, Detroit diesel: 5196168, JP 09-814B	12	22,5	95	88,5	
500163	G	Jabsco: 17938-0001, Volvo: 3830459, DJ pump: 09-45-1201, JMP: 8326-01	12	22,5	95	95	
500144		Jabsco: 17240-0001, 18789-0001, DJ pump: 08-14-1001, 08-15-0901, JMP: 9001-01	9	22,5	117,6	88,5	
500105	GT	Jabsco: 836-0001, Vetus: IMP00901, Volvo: 807904, 875660-3, 875736-1, 21430184, 21730344, 21951360, Caterpillar: 1L4774, Cummins: 10556540, Detroit diesel: 5193553, JP-1029B	9	22,5	96	63,1	
500172		Jabsco: 50668, DEV4307	9	38,82	119,7	133	
500186	T	DJ Pump: 08-30-1201	12	22,5	96,5	130	



allpa impellers with code 'G', 'GT' and 'GX' are including gasket!  
G: Gasket | T: Cap | X: Screw | C: Key. **Made in the EU**



## Impellers 3

Item Code	Note	Ref.	No. of Vanes	Dimensions			
				A	B	C	
500322		Yamaha: 6L5-44352-00-00, Parsun: F2,6-030000100	6	10	36	14,5	
500302		Yamaha: 6G1-44352-00-00	6	11,9	40	18	
500127		Renault: 48300037, R48300055	6	10	50,8	22,1	
500319		Suzuki: 17461-93901, 17461-92D02, 17461-93903	6	12,2	42	20	
500350		OMC-Johnson-Evinrude: 277181, 434424	6	10,93	69	12,72	
500129		Jabsco: 22799-0001, Vetus: IMP00101, Yanmar: 104223-42091, 124223-42092, 128620-42092, 128620-42200, 128296-42070, DJ pump: 08-37-0601, JMP: 7052-01, JP-09-827	6	12,75	50,8	22,1	
500325		Mariner-Mercury-Mercruiser: 47-96305M, Yamaha: 6E0-44352-00-00, Parsun: F15-06050000	6	11	40	12,6	
500351		OMC-Johnson-Evinrude: 375638, 775518	6	12,75	69	12,72	
500369		OMC-Johnson-Evinrude: 382221	6	11	47,5	13,7	
500166	G	DJ pump: 08-32-1201, Sherwood: 10077K, Westerbeke: 33112, 11764, JMP: 7110-01, Onan: 132-0375	12	12,8	56,6	19,8	

## Impellers 3



allpa impellers with code 'G', 'GT' and 'GX' are including gasket!  
G: Gasket | T: Cap | X: Screw | C: Key. **Made in the EU**



See from p. 494, 498-501 for Johnson Impellers

	Item Code	Note	Ref.	No. of Vanes	Dimensions		
					A	B	C
	500324		Yamaha: 646-44352-01-00	6	11,15	47,5	13,7
	500363		Yamaha: 63V-44352-01-00, Selva: 63V-44352-01, Parsun: F4-03060000	6	12,85	53	14
	500354	G	OMC-Johnson-Evinrude: 389576, 436137	6	11,2	38,4	17,9
	500320		Yamaha: 682-44352-01-00, Mariner-Mercury-Mercruiser: 47-84027	6	13	40	22
	500368		Yamaha: 68T-44352-00-00, Selva: 68T-44352-00	6	11,6	53	14
	500347		Honda: 19210-ZW9-003, 19210-ZW9-013	6	13	45,6	14,8
	500329		Suzuki: 17461-93902	6	13,2	39,3	22
	500103	GT	Jabsco: 18838-0001, Volvo: 833512-5, 3854286, Yamaha: YSC-101-03-01-0C, Perkins: NA 900010, 24880178, 24880178, Sherwood: 9959K	12	15,9	62	31,7
	500383		Tohatsu: 334-65021-0, 334-65021-0M	8	13,97	40,8	23,4
	500102	T	Jabsco: 4598-0001, Volvo: 818680, DJ pump: 08-46-0801, JMP: 7410-01, Oberdorfer: 6603	8	15,9	65	50,2
	500384		Yamaha: 6L2-44352-00-00	6	13,97	51,2	19,05
	500120	GT	Jabsco: 18948-0001, Volvo: 835874, Yamaha: 6TA-12457-00, Sherwood: 10615K, Perkins: NA 900012, DJ pump: 08-20-1201	12	15,9	65,2	41,3
	500321		Mariner-Mercury-Mercruiser: 47-95611M, Yamaha: 662-44352-01-00	6	14	40	22
	500108	CGT	Jabsco: 4568-0001, Yanmar: 145410-46090, JP-801B, VP-3862465, 124310-46090, DJ pump: 08-22-1201, Oberdorfer: B6620	12	15,93	57	31,6
	500349		OMC-Johnson-Evinrude: 377178, 775519	6	14	69	12,72
	500160		Jabsco: 4599-0001GF, Volvo: PM14320/620	8	15,93	65,2	50,2
	500343		Honda: 19210-ZV4-651	6	14,1	41	28,55
	500398		Suzuki: 17461-93001, 17461-93004	6	15,25	70,5	12,1
	500165	G	Yanmar: 128620-42200, Sherwood: 9000K, Dj pump: 09-106-1201, JMP: 7172-0, Westerbeke: 302875	12	15,95	62,2	22,4
	500374		OMC-Johnson-Evinrude: 389983	6	15,94	51,2	19,05
	500170	CG	Volvo: 875575-3, 21951350, 831182	12	16	57	31,6
	500167	G	Jabsco: 18327-0001, Sherwood: 15000K, DJ pump: 08-36-1201, JMP: 7352-01	12	16	65	51,2
	500362	G	Suzuki: 17461-96301	6	17,1	67	16,5



allpa impellers with code 'G', 'GT' and 'GX' are including gasket!  
G: Gasket | T: Cap | X: Screw | C: Key. **Made in the EU**



## Impellers 3

See from p. 494, 498-501 for Johnson Impellers

Item Code	Note	Ref.	No. of Vanes	Dimensions			
				A	B	C	
500366		OMC-Johnson-Evinrude: 378891, 775521	6	16	69	12,72	
500361		Suzuki: 17461-94700	6	17,1	67	19	
500352		OMC-Johnson-Evinrude: 377230, 777213	6	16,04	69,8	22,1	
500399		Suzuki: 17461-96400, 17461-96402	6	17,2	67	16,16	
500385	G	Yamaha: 6H4-44352-02, Selva: 6H4-44352-02, Parsun: F25-04040000	6	16,1	51,2	19,05	
500339		Honda: 19210-ZV7-003	6	17,2	55,75	20,2	
500326		Mariner-Mercury-Mercruiser: 47-84797M, 47-84797, Yamaha: 689-44352-02-00	6	16,15	69,5	12,72	
500338		Honda: 19210-ZV5-003	6	17,2	55,75	20,2	
500348		Honda: 19210-ZW9-A31, 19210-ZW9-A32	6	16,20	45,6	14,8	
500379		Tohatsu: 3C8-65021-2, 3C8-65021-2M	6	17,2	50,4	20,2	
500122		Renault Couach: 48300008	8	17	65	48,6	
500382		Tohatsu: 345-65021-0, 3R0-650-210M	6	17,2	44,25	20,25	
500128		Renault Couach: R48300006, 48300007	8	17	66	32	
500353		OMC-Johnson-Evinrude: 390286	6	17,5	51,2	19,05	
500316		Yamaha: 697-44352-00-00, 6H3-44352-00-00, Selva: 6H3-44352-00, Mariner-Mercury-Mercruiser: 47-97108	6	18,05	51,80	19	
500397		Chrysler/Force: 47-F84064	12	20,8	56,6	19,8	
500306		OMC-Johnson-Evinrude: 385072	6	19,13	89	31,9	
500390		Chrysler/Force: 47-803630T, 47-F523065-1	6	21	57,2	29,6	
500307		OMC-Johnson-Evinrude: 382547	6	19,25	91,5	25,4	
500365		Suzuki: 17461-87E00, 17461-87E10, 17461-87E11	6	22,2	78,3	26	
500164	GT	Jabsco: 18598-0001, Sherwood: 17000K, Cummins: 3802444, 3897337, 3916852, 3925236, Caterpillar: 1W5664, DJ pump: 08-19-1201, JMP: 7600-01	12	20,1	84	73,5	
500356		OMC-Johnson-Evinrude: 397475, 777130	6	22,3	109,5	24,8	
500364		Yamaha: 67F-44352-00, Selva: 67F-44352-00-00	6	20	58,2	34,7	

## Impellers 3



allpa impellers with code 'G', 'GT' and 'GX' are including gasket!  
G: Gasket | T: Cap | X: Screw | C: Key. **Made in the EU**



See from p. 494, 498-501 for Johnson Impellers

	Item Code	Note	Ref.	No. of Vanes	Dimensions		
					A	B	C
	500305		OMC-Johnson-Evinrude: 389642, 777212	6	22,3	89	31,9
	500360		Suzuki: 17461-95300, 17461-95501	6	20	67,5	19
	500371		Yamaha: 6E5-44352-00-00, 6E5-44352-01-00	6	22,4	89	31
	500323		Yamaha: 688-44352-03-00	6	20,1	58	30
	500337		Honda: 19210-ZW1-B02, 19210-ZW-1-B04	6	23,35	87,8	31
	500388		Tohatsu: 3C7-65021-1, 3C7-65021-1M, 3B7-65021-2	6	20,3	65,75	35,2
	500393		Suzuki: 17461-93J00	5	24,3	87	39
	500367		Suzuki: 17461-94510, 17461-94511, 17461-90J00, 17461-90J01	6	24,4	86	31,7
	500391		Honda: 19210-ZY3-003	6	26	89,75	31,3
	500389	N	Yamaha: 6AW-44352-00	6	24,6	89	36

## Impellers 4



allpa impellers with code 'G', 'GT' and 'GX' are including gasket!  
G: Gasket | T: Cap | X: Screw | C: Key. **Made in the EU**



	Item Code	Note	Ref.	No. of Vanes	Dimensions		
					A	B	C
	500110		Jabsco: 7273-0001, 6303-0001, Oberdorfer: 6617	6	7,31	50,8	22,1
	500138		Jabsco: 6303-0001, JM: 7053-01, Oberdorfer: 6617	6	7,31	51,3	22
	500284	G	Honda: 19210-ZW1-003	6	7,4	35,4	12,8
	500232		Vetus IMP00401	6	8	44,6	13
	500113		Jabsco: 1411-0001, 1414-0001, Yanmar: 128176-42071 (1GM)	6	8	31,3	11,9
	500130		Jabsco: 1414-0001, 14609-0001, 14787-0001, JMP: 6000-01, Yanmar: 128170-42070	6	8	31,75	12
	500190	G	DJ Pump: 09-107-0601, JMP 7013-01, Kohler: 359978, Sherwood: 8000K, 29000K ONAN 0541-1524	6	12,2	40	19
	500328		Honda: 19210-ZV4-013	6	13,15	41	28,55
	500327		Honda: 19210-881-003, 19210-881-A02	8	13,15	41	23
	500148		Jabsco: 17954-0001, DJ Pump: 09-201-1001	10	16,85	65	50,7
	500109		Mariner-Mercury-Mercruiser: 47-59362T 1, Caterpillar: 7C-3286 47-59362Q01	8	16,85	66,5	50,6





allpa impellers with code 'G', 'GT' and 'GX' are including gasket!  
G: Gasket | T: Cap | X: Screw | C: Key. **Made in the EU**



## Impellers 5

See from p. 494, 498-501 for Johnson Impellers

Item Code	Note	Ref.	No. of Vanes	Dimensions			
				A	B	C	
500313	G	Chrysler-Force: 47-F694065, 47-803631T, Mariner-Mercury-Mercruiser: 47-65960, 47-89984T4, 47-F694065, 47-803631T, 47-30221	6	22,3	60	33,8	
500301	N	Honda: 19210-ZW1-003, 19210-ZW1-303, Mariner-Mercury-Mercruiser: 47-43026T2, 47-43026-2, 47-430262Q02	6	22,4	89	32,5	
500377		Mariner-Mercury-Mercruiser: 47-16154 B, 47-16154-3 Tohatsu: 369-65021-1, 369-65021-1M	6	10,25	33,6	14,2	
500358		OMC-Johnson-Evinrude: 387361	6	10,94	38,4	17,8	
500314		Mariner-Mercury-Mercruiser: 47-68988, 47-89980	6	11	32	14,35	
500332		OMC-Johnson-Evinrude: 433915, 433935	3	11,12	39	17,7	
500309		Mariner-Mercury-Mercruiser: 47-22748	6	11,6	32	14,40	
500310		Mariner-Mercury-Mercruiser: 47-65957, 47-89981	6	11,6	32	14,40	
500344		Mariner-Mercury-Mercruiser: 47-436065-2	6	12	40	18	
500355		OMC-Johnson-Evinrude: 386084	6	12,75	38,4	17,8	
500318		Mariner-Mercury-Mercruiser: 47-42038	6	13	58,8	11,7	
500311	G	Mariner-Mercury-Mercruiser: 47-89982, 47-65958	6	15,95	51,2	19,05	
500315		Mariner-Mercury-Mercruiser: 47-85089-3, 47-85089-10	6	16	73	12,6	
500357	G	OMC-Johnson-Evinrude: 388702	6	15,95	51,2	19,05	
500345		OMC-Johnson-Evinrude: 389589	6	16,04	69,20	22,25	
500312		Mariner-Mercury-Mercruiser: 47-20268, 47-65959, 47-89983T Suzuki: 17461-95201	6	19,13	51,8	19	
500378		Mariner-Mercury-Mercruiser: 47-19453T	6	19,25	78,2	25,15	



allpa impellers with code 'G', 'GT' and 'GX' are including gasket!  
G: Gasket | T: Cap | X: Screw | C: Key. **Made in the EU**



## Impellers 6

Item Code	Note	Ref.	No. of Vanes	Dimensions			
				A	B	C	
500334		Chrysler-Force: 47-F436065-2	6	12,85	57	14,8	
500342		Chrysler-Force: 47-F433065	6	15,96	57	15	
500335		Chrysler-Force: 47-F462065	10	14,35	57,5	15	
500333		-	6	14,5	56,6	15,1	

### Impellers 7



allpa impellers with code 'G', 'GT' and 'GX' are including gasket!  
G: Gasket | T: Cap | X: Screw | C: Key. **Made in the EU**



See from p. 494, 498-501 for Johnson Impellers

	Item Code	Note	Ref.	No. of Vanes	Dimensions		
					A	B	C
	500330		Chrysler-Force: 47-F525065	6	11	36,5	18,1

### Impellers 8



allpa impellers with code 'G', 'GT' and 'GX' are including gasket!  
G: Gasket | T: Cap | X: Screw | C: Key. **Made in the EU**



	Item Code	Note	Ref.	No. of Vanes	Dimensions		
					A	B	C
	500370	C	OMC-Johnson-Evinrude: 385289, 395289	6	15,94	51,2	19,05
	500346	C	OMC-Johnson-Evinrude: 396809, 777214	6	16,04	70	22,3
	500372	C	OMC-Johnson-Evinrude: 432941	3	19,15	91,3	25,4
	500373	C	OMC-Johnson-Evinrude: 437059, 438592	3	19,15	91,3	25,4
	500303	C	OMC-Johnson-Evinrude: 396725, 437080, 432954	6	19,15	91,5	25,4
	500308	CR	OMC-Johnson-Evinrude: 397131, 435821, 395864, 435748, 5001593	6	22,31	89	32,03

### Impellers 9



allpa impellers with code 'G', 'GT' and 'GX' are including gasket!  
G: Gasket | T: Cap | X: Screw | C: Key. **Made in the EU**



	Item Code	Note	Ref.	No. of Vanes	Dimensions		
					A	B	C
	500380		Volvo: 3555413-8	12	10	39,6	14,3
	500336		Suzuki: 17461-98501, 17461-98503, 17461-98502 4-5-6 pk	6	10	41	14
	500396		Mariner-Mercury-Mercuriser: 47-95289/2 OMC-Johnson-Evinrude: 114812 Tohatsu: 309-65021-1, 309-65021-1M	6	12	41	14

### Impellers 10



allpa impellers with code 'G', 'GT' and 'GX' are including gasket!  
G: Gasket | T: Cap | X: Screw | C: Key. **Made in the EU**



	Item Code	Note	Ref.	No. of Vanes	Dimensions		
					A	B	C
	500394		OMC-Johnson-Evinrude: 986465	10	12,7	58,5	21,5
	500317		OMC-Johnson-Evinrude: 983895	10	12,76	58,5	40,41

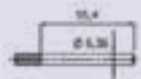

allpa impellers with code 'G', 'GT' and 'GX' are including gasket!  
G: Gasket | T: Cap | X: Screw | C: Key. **Made in the EU**



### Impellers 11

See from p. 494, 498-501 for Johnson Impellers



Item Code	Note	Ref.	No. of Vanes	Dimensions			
				A	B	C	
500258		Jabsco: 17255-0003	6	6,36	39,1	18,9	



allpa impellers with code 'G', 'GT' and 'GX' are including gasket!  
G: Gasket | T: Cap | X: Screw | C: Key. **Made in the EU**



### Impellers 12

Item Code	Note	Ref.	No. of Vanes	Dimensions			
				A	B	C	
500157		Jabsco: 50461-1001, DJ Pump: 008-1001	10	13,42	57,18	50,25	
500152		Jabsco: 17370-0001, DJ Pump: 088-1201, JMP: 8300-01	12	20,2	95	88,5	
500153		Jabsco: 18786-0001, JMP: 9000-01	9	20,2	117,6	88,5	



allpa impellers with code 'G', 'GT' and 'GX' are including gasket!  
G: Gasket | T: Cap | X: Screw | C: Key. **Made in the EU**



### Impellers 13







Item Code	Note	Ref.	No. of Vanes	Dimensions			
				A	B	C	
500159	G	Mariner-Mercury-Mercruiser: 47-862232A2, DJ Pump: 09-47-0801	8	11,4	66,5	50,6	



allpa impellers with code 'G', 'GT' and 'GX' are including gasket!  
G: Gasket | T: Cap | X: Screw | C: Key. **Made in the EU**



### Impellers 14

Item Code	Note	Ref.	No. of Vanes	Dimensions			
				A	B	C	
500177	GT	Jabsco: 17018-0001, Volvo: 3593573, 3588476, 3583602, 3819486	8	14,29	65,2	75,65	
500181	G	Cummins: 3974456, DJ Pump: 08-35-1201, Sherwood: 27000K	12	16,1	84	73	
500183	G	DJ Pump: 08-34-1201, Sherwood: 26000K	12	20	94,5	79,8	
500192	GX	Sherwood: 29000K	12	20	94,5	101,5	
500182	GX	Caterpillar: 1095324, Cummins: 4019403, DJ Pump: 08-33-1201, JMP: 8350-01, Sherwood 18000K	12	20,7	94,5	101,5	
500179	GX	DJ Pump: 09-49-1001, Sherwood: 22000K	10	20,7	114,3	109,5	

**Item Code 087500**  
Impuller (Impellerpuller)

**Impellerpuller**

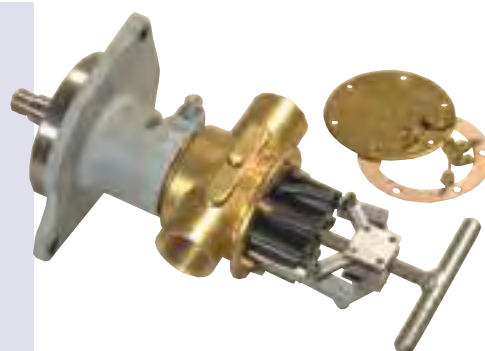

**JABSCO**

11979-0001	500155
1210-0001	500107
1210-0003	500207
13554-0001	500124
13554-6001	500150
1411-0001	500113
1414-0001	500113
1414-0001	500130
1414-0003	500230
14609-0001	500130
14787-0001	500130
14787-0003	500213
17018-0001	500187
17018-0001	500177
17018-0001B	500177
17240-0001	500144
17255-0003	500258
17370-0001	500152
17935-0001	500135
17936-0001	500145
17937-0001	500114
17937-0003	500214
17938-0001	500163
17954-0001	500148
18327-0001	500167
18653-0001	500146
18673-0001	500156
18777-0001	500133
18786-0001	500153
18789-0001	500144
18838-0001	500103
18948-0001	500120
18958-0001	500164
21676-0001	500145
22120-0001	500104
22405-0001	500121
22799-0001	500129
3085-0001	500107
31130-0061	500161
4528-0001	500100
4568-0001	500108
4568-0003	500208
4598-0001	500102
4598-0003	500202
4599-0001GF	500160
50461-1001	500157
50668	500172
6303-0001	500138
6303-0001	500110
6303-0003	500238
653-0001	500101
653-0003	500201
673-0001	500116
673-0003	500216
6760-0001	500115
7273-0001	500110
7273-0003	500210
836-0001	500105
836-0003	500205
920-0001	500106
920-0003	500206
DEV4307	500172

**OEM****HONDA**

19210-881-003	500327
19210-881-A02	500327
19210-ZV4-013	500328
19210-ZV4-651	500343
19210-ZV5-003	500338
19210-ZV7-003	500339
19210-ZW1-003	500301
19210-ZW1-303	500301
19210-ZW1-B02	500337
19210-ZW1-B04	500337
19210-ZW9-003	500347
19210-ZW9-013	500347
19210-ZW9-A31	500348
19210-ZW9-A32	500348
19210-ZY3-003	500391

**SUZUKI**

17461-87E00	500365
17461-87E10	500365
17461-87E11	500365
17461-90J00	500367
17461-90J01	500367
17461-92D02	500319
17461-93001	500398
17461-93004	500398
17461-93901	500319
17461-93902	500329
17461-93903	500319
17461-93J00	500393
17461-94510	500367
17461-94511	500367
17461-94700	500361
17461-95201	500312
17461-95300	500360
17461-95501	500360
17461-96301	500362
17461-96400	500399
17461-96402	500399
17461-98501	500336
17461-98502	500336
17461-98503	500336

**YANMAR**

104211-42070	500100
104211-42071	500100
104223-42091	500129
119574-42550	500162
119574-42552	500162
119593-42200	500161
119593-42202	500161
119773-42600-01	500124

**YAMAHA**

63V-44352-01-00	500363
646-44352-01-00	500324
662-44352-01-00	500321
67F-44352-00-00	500364
682-44352-01-00	500320
688-44352-03-00	500323
689-44352-02-00	500326
68T-44352-00-00	500368
697-44352-00-00	500316
6AW-44352-00	500389
6E0-44352-00-00	500325
6E5-44352-00-00	500371
6E5-44352-01-00	500371
6F5-44352-00-00	500352
6G1-44352-00-00	500302
6H3-44352-00-00	500316
6H4-44352-02-00	500385
6L2-44352-00-00	500384
6L5-44352-00-00	500322
6TA-12457-00	500120
6TA-12457-00	500124
6TA-12457-00	500120
YSC-101-03-01-0C	500103

**VETUS**

IMPO0101	500129
IMPO0101	500116
IMPO0201	500107
IMPO0301	500106
IMPO0301	500114
IMPO0401	500232
IMPO0501	500100
IMPO0601	500121
IMPO0701	500146
IMPO0801	500145
IMPO0901	500105

**NANNI**

434013	500121
434014	500101

for Info and Parts  
CHECK

[www.allpa-marine.com](http://www.allpa-marine.com)





***Don't be the same,  
be better!***



**allpa**  
marine equipment

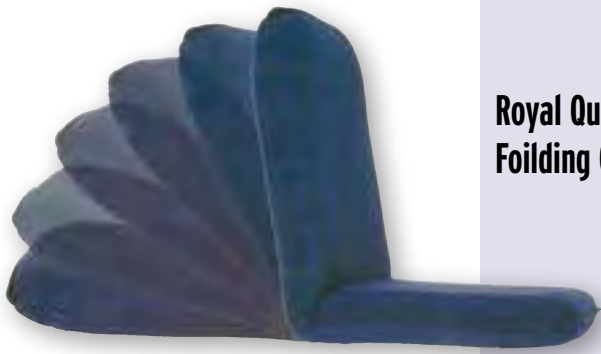

**Royal Queen  
Folding Chair**

6-Position Back Rest

**Item Code 069600**

Foldable chair / deck chair with 6 positions  
Color: dark blue  
Dims. unfolded (back flat): 850x420mm (lxw)  
Dims. folded (back upright): 500x420x450mm (hxwxd)  
Weight: ± 3 kg.

H	h	W	w	D	d	TR
500	-	420	-	450	-	-



**Skipper  
Folding Chair**

**Item Code 069201**

Folding chair model Skipper, color: grey  
Contemporary design. Standard 4 hole pattern  
Without pedestal. Folding height: 200mm.

**Item Code 069202**

Marine grade vinyl cushion set, color grey/dark blue.

H	h	W	w	D	d	TR
457	-	495	-	432	-	305



**Traveller  
Folding Chair**

**Item Code 069450**

Modern, comfortable and solid folding chair with fixed cushions. Chair color: light grey.

Cushions color; light grey/dark blue. Standard 4-hole pattern.  
Without pedestal  
Folding height 310mm

H	h	W	w	D	d	TR
360	-	510	-	460	-	340



**Kos Side  
Utility Seat**

**Item Code 069125**

Folding side utility seat, white marine grade vinyl with dark blue piping. Comes with gimbal for bulkhead mount.

H	h	W	w	D	d	TR
-	-	340	-	430	-	-

**Item Code 069500**

Folding chair model Coach. White with dark blue. Thick cushions of marine grade vinyl. Anodized aluminum hinges. Standard 4-hole pattern for universal mounting. Without pedestal. Folding height 240mm.

H	h	W	w	D	d	TR
460	-	420	-	400	360	-

**Item Code 069550** Replacement screw kit (4 pcs, ¼ x 2")

**Item Code 069552** Replacement hinge kit (l+r)

**Coach Folding Upholstered Boat Chair**



**Item Code 069501**

Folding chair model Coach de Luxe, navy. Thick cushions of marine grade vinyl. Anodized aluminum hinges. Standard 4-hole pattern for universal mounting. Without pedestal. Folding height 240mm.

H	h	W	w	D	d	TR
460	-	420	-	400	360	-

**Item Code 069550** Replacement screw kit (4 pcs, ¼ x 2")

**Item Code 069552** Replacement hinge kit (l+r)

**Coach de Luxe Folding Upholstered Boat Chair**



Folding bench Coach de Luxe Twin. Thick cushions of marine grade vinyl. Anodized aluminum hinges. Without pedestal

**Item Code 069221** Coach de Luxe Twin White

**Item Code 069222** Coach de Luxe Twin Navy

**Coach de Luxe Twin**

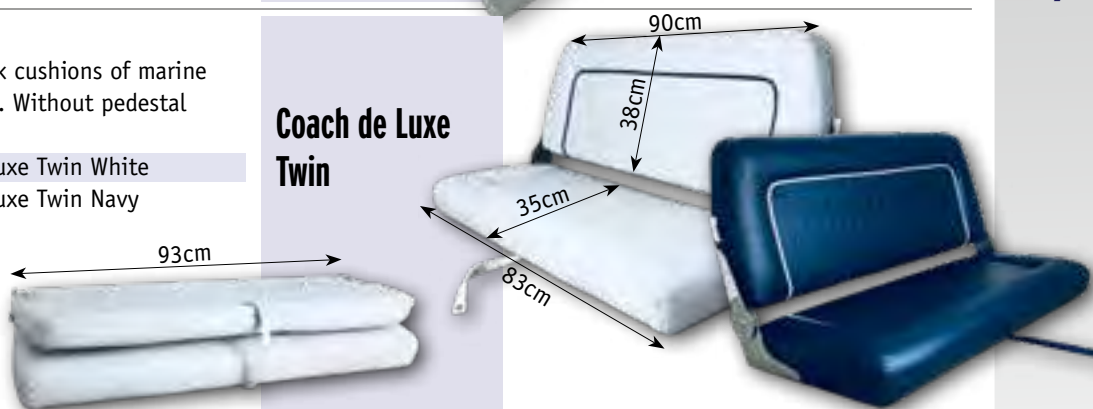

**Folding chair Corfu**

Thick cushions of marine grade vinyl and aluminum hinges. Standard 4-hole pattern. Without pedestal. Folding height 240mm.

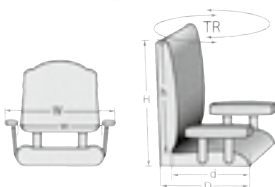

**Item Code 069120** Corfu, white

**Item Code 069122** Corfu, dark blue

**Item Code 069123** Corfu, grey

H	h	W	w	D	d	TR
460	-	420	-	460	360	-

**Corfu Folding Upholstered Boat Chair**



**Item Code 069126**

Boat Chair "Athene" with Reversible back seat, white marine grade vinyl. Convenient watching skiers or wake-boarders. Standard 4-hole pattern. Without pedestal.

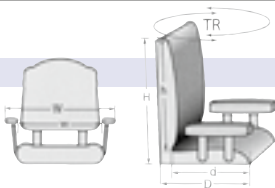

H	h	W	w	D	d	TR
546	-	533	-	559	-	-

**Athene "Flip-Back" Boat Chair**





**Twin  
"Flip-Back"  
Boat Chair**

**Item Code 069220**

Boat Chair Twin, light grey with dark grey marine grade vinyl. Without pedestal.

H	h	W	w	D	d	TR
520	-	440	-	560	430	620



**Sport Pro  
"Flip up"  
Boat Chair**

**Item Code 069270**

Boat Chair Sport Pro, white marine grade vinyl with "carbon" details. With "Thigh Rise" Flip Up or "Lean To" position when standing is necessary for steering. Good support due to bucket seat form. Without pedestal.

H	h	W	w	D	d	TR
630	-	530	-	590	-	-



**Ocean 51  
"Flip Up"  
Boat Chair**

**Item Code 069235**

Boat chair Ocean 51 with grey colored heavy duty water proof marine fabric with black "Alcantara". Front hinge converts the seat into a "Thigh Rise". Use as "Lean To" when standing while steering. Standard 4-hole pattern. Without pedestal.

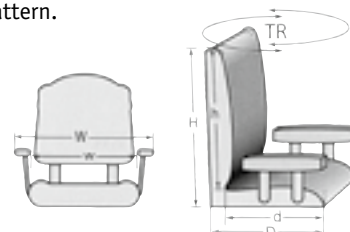

H	h	W	w	D	d	TR
410	-	440	-	540	430	-



**Race Pro  
"Flip-Up"  
Boat Chair**

**Boat Chair "Race Pro"**

Front hinge converts the seat into a "Thigh Rise". Use as "Lean To" when standing while steering. Standard 4-hole pattern. Without pedestal.

**Item Code 069237**

Race Pro - Color: Dark Blu with white stitching

**Item Code 069238**

Race Pro - Color: Charcoal-grey with white stitching

**Item Code 069184**

Special Slide for these chairs  
Adds 1-1/4" (32mm) to pedestal height.  
Large mounting plate 8 x 13" (203x330mm).  
For use with Ø 2-7/8" (73mm) pedestal.

H	h	W	w	D	d	TR
640	-	500	-	540	-	-



**Item Code 069215**

Boat Chair Royal, white marine grade vinyl. Comfortable chair with arm rests. Standard 4-hole pattern. Without pedestal.

H	h	W	w	D	d	TR
450	-	650	470	560	-	-

**ROYAL  
Boat Chair**



**Item Code 069112**

Bucket seat Kreta, white polythene with grey marine grade vinyl cushions. Standard (long) 4-hole pattern: Item Code 069403 Fixed, Item Code 069185 360°. See p. 156. Without pedestal.

H	h	W	w	D	d	TR
419	-	483	-	432	-	-

**Kreta  
Bucket Seat**



**Item Code 069129**

Boat Chair Naxus, white marine grade vinyl. With "Thigh Rise" Flip Up or "Lean To" position when standing is necessary for steering. Good support due to bucket seat form. Without pedestal. Must be mounted with universal track lock slide (p. 160).

H	h	W	w	D	d	TR
572	-	533	-	572	-	-

**Naxus  
"Flip up"  
Boat Chair**



**Item Code 069275**

Boat Chair Romeo, marine grade vinyl. With "Thigh Rise" Flip Up or "Lean To" position when standing is necessary for steering. Good support due to bucket seat form. Without pedestal.

H	h	W	w	D	d	TR
520	-	580	-	580	-	-

**Romeo  
"Flip up"  
Boat Chair**





### Royal de Luxe Helmsman Chair Package

#### Item Code 069227

Royal de Luxe Helmsman chair, black vinyl, with **fixed height** aluminum pedestal. Heavy Duty Pilot Seat System.

#### Package deal, complete set:

- Chair with reclining back (45°) back and flip up armrests.
- Aluminum polished fixed height pedestal 4" (Ø101,6mm) thick wall (5,4mm) and pressed base Ø305mm.
- Aluminum "Workhorse"- slide adjusts 152mm with 7x lock, rotating 360° with 3x heavy duty lock.
- Aluminum slide-out footrest, black polyboard platform, round pedestal mount.

**NEW**



### Mariner de Luxe Helmsman Chair Packages

#### Item Code 069145

Mariner de Luxe Helmsman chair, black vinyl with **fixed height** aluminum pedestal. Heavy Duty Pilot Seat System.

#### Package deal, complete set:

- Chair with reclining back (45°) back and flip up armrests.
- Aluminum polished fixed height pedestal 4" (Ø101,6mm) thick wall (5,4mm) and pressed base Ø305mm.
- Aluminum "Workhorse"- slide adjusts 152mm with 7x lock, rotating 360° with 3x heavy duty lock.
- Aluminum footrest with foldable platform, black coating, mounts to bottom of seat.

#### Item Code 069146

Mariner de Luxe Helmsman chair, black vinyl with **adjustable height** aluminum pedestal. Heavy Duty Pilot Seat System.

#### Package deal, complete set:

- Chair with reclining back (45°) back and flip up armrests.
- Aluminum polished pedestal 4" (Ø101,6mm), thick wall (5,4mm) with air-powered height adjustment 56-81cm, pressed base Ø305mm.
- Aluminum "Workhorse"- slide adjusts 152mm with 7x lock, rotating 360° with 3x heavy duty lock and pedestal height control.
- Aluminum footrest with foldable platform, black coating, mounts to bottom of seat.



### 4" Mainstay Separate parts

**Code 069494** Aluminum "Workhorse"- slide adjusts 152mm with 7x lock, rotating 360° with 3x heavy duty lock.

**Code 069381** Aluminum "Workhorse"- slide adjusts 152mm with 7x lock, rotating 360° with 3x heavy duty lock and pedestal height control.

**Code 069493** Aluminum polished fixed height pedestal 4" (Ø101,6mm), thick wall (5,4mm) and pressed base Ø305mm.

**Code 069397** Aluminum polished pedestal 4" (Ø101,6mm), thick wall (5,4mm) with air-powered height adjustment 56-81cm, pressed base Ø305mm.

**Code 069382** Aluminum slide-out footrest, black polyboard platform, round pedestal mount.

**Code 069396** Aluminum footrest with foldable platform, black coating, mounts to bottom of seat.

**Item Code 084780**

Allpa Swing Back Seat – 47 Litre storage. Durable Polyethylene construction, 47 liter insulated storage in base, Stainless steel swing arms, Marine grade vinyl upholstery, Internal drain.

**Item Code 084785**

Protective Cover, vinyl, khaki color (47l&66l)

D = 46cm  
W = 90cm  
H = 48cm  
OH = 81cm

**allpa  
Swing Back Seat  
47l**

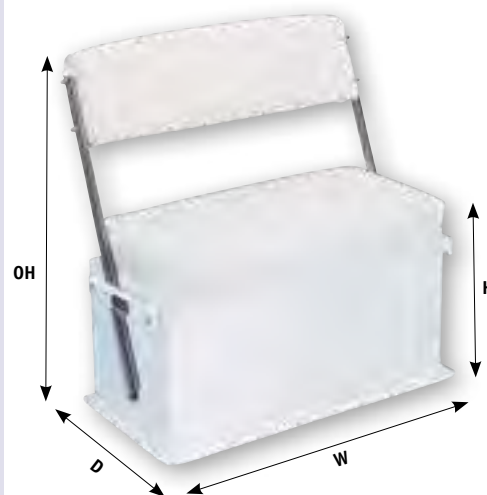

**Item Code 084800**

Allpa Swing Back Seat – 66 Litre storage. Durable Polyethylene construction, 66 liter insulated storage in base, Stainless steel swing arms, Marine grade vinyl upholstery, Internal drain.

**Item Code 084785**

Protective Cover, vinyl, khaki color (47l&66l)

D = 45cm  
W = 96,5cm  
H = 52cm  
OH = 85cm

**allpa  
Swing Back Seat  
66l**

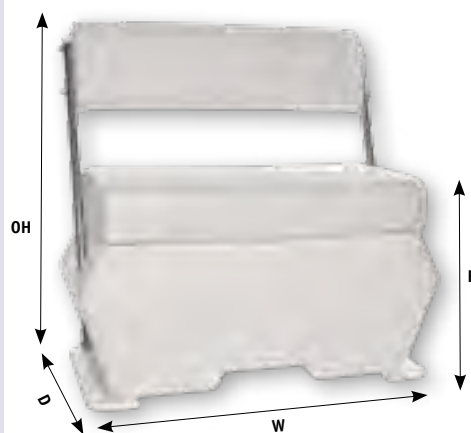

**Item Code 069231**

Reversible back seat with arm rest, white marine grade vinyl. With "Thigh Rise" Flip Up or "Lean To" position (1-side) when standing is necessary for steering. Convenient watching skiers or wake-boarders. Standard 4-hole pattern. Without pedestal.

H	h	W	w	D	d	TR
584	-	584	-	609	-	-

**Twin 46  
"Flip-Back "  
Boat Chair  
with arm rest**



**Item Code 069232**

Bench seating for two. Double Bucket seat with flip back feature with arm rests. White marine grade vinyl. Convenient watching skiers or wake-boarders. Suitable for pedestal or box style mounting. Without pedestals.

Standard 4-hole pattern: 5"x12" (2 times)

H	h	W	w	D	d	TR
533	-	1041	-	609	-	-

**Twin 46  
Double Bucket  
"Flip-Back "  
Boat Seat  
with arm rest**





**Folding Chair  
Skipper Standard**

**Item Code 069920**

Skipper folding boat chair, Gray/Charcoal. Molded seats with interlocking hinge for greater structural support. Extra wide seat with high quality upholstery for all day comfort. Standard 4-hole pattern. Complete with marine grade vinyl cushion set. Hight in folded position: 200mm

H	h	W	w	D	d	TR
460	-	510	-	430	-	-



**Skipper de Luxe  
Folding Chair**

**Item Code 069205**

Folding chair model Skipper-de Luxe  
Complete with marine grade vinyl cushion set

Color: grey//anthracite  
Standard 4-hole pattern. Without pedestal  
Folding height 200mm

H	h	W	w	D	d	TR
360	-	510	-	460	-	340



**Fish Pro  
Folding  
Chair**

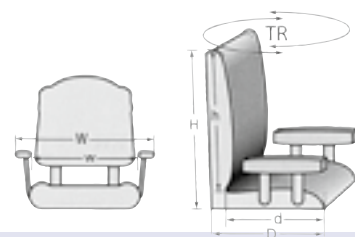

**Item Code 069260**

Fish Pro folding chair, black with grey marine grade vinyl.  
Comfortable fishing chair with perfect support.  
Without pedestal.

H	h	W	w	D	d	TR
660	-	480	-	540	-	-



**TEREC Folding  
Chair**

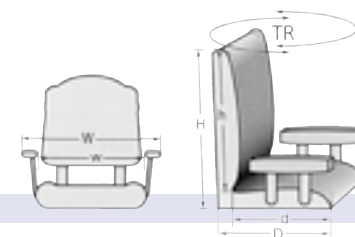

**Item Code 069261**

Folding chair TERC grey with anthracite.  
Very comfortable chair with an extremely stable frame.

H	h	W	w	D	d	TR
660	-	480	-	540	-	-

**Item Code 069506**

Premium Folding High Back Seat, Gray/Charcoal, High quality upholstery and cushions. Double stitch. Standard mounting pattern.

H	h	W	w	D	d	TR
600	-	450	-	540	-	-

**Fisherman Folding Chair**

**NEW**



**Item Code 069937**

Premium Folding High Back Seat, Gray/Charcoal, Pinchless High quality upholstery and cushions with rigid injection molded frame. Double stitch. Standard mounting pattern.

H	h	W	w	D	d	TR
610	-	410	-	390	-	-

**Fishmaster Folding Chair**

**NEW**



**Item Code 069449**

With this extremely compact damping system, an 8 cm spring travel is possible. The damping hardness is adjustable by the integrated handle. For more information and applications, please contact allpa.

**WAVE damping**



**Item Code 069469**

Easy to install and remove from boat. Bracket allows seat to slide side to side for comfort and convenience. Locking mechanism prevents tipping forward in sudden stop situations. Commonly used on Tiller style boats.

**Universal slide**

**NEW**





### Seat Swivel

**Item Code 069404**

360° swivel without lock made of black painted steel.  
Dims. 175 x 175 x 25mm.  
Standard 4-hole pattern.

**Item Code 069474**

As above but with lock.



### Removable Seat Bracket & Swivel

**Item Code 069437**

Removable seat bracket with non-locking seat swivel.  
Easy Click-system  
Black E-Coated steel. Dims. 175 x 175 x 25mm.



### Stainless Steel Seat Swivel

**Item Code 069180** 12-Way Locking Swivel

**Item Code 069181** Swivel without Lock

360° Swivels with nylon bushing instead of ball bearings.  
Great swiveling and better resistant against seawater.  
Standard 4-Hole mounting pattern. 3° Seat angle.

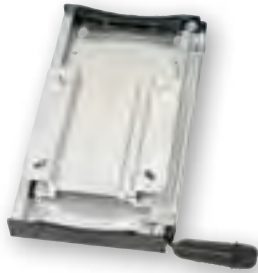

### Universal Track Lock Slide

**Item Code 069403**

12- Position track, 114 mm range aluminum & plastic slide.  
Fits every boat chair or pedestal. Also suitable for deck mount.  
Dims. 330x185x50mm (lxwxh).

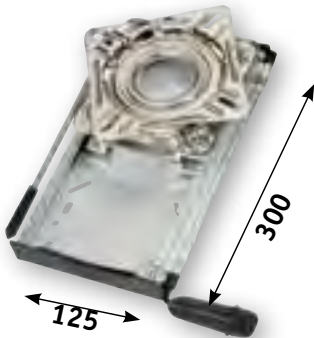

### Universal Track Lock Slide with Swivel

**Item Code 069185**

Exceeds ABYC H-31 Standard for Class AD or AP applications.  
360° Swivel with auto lock in forward position. 12-Position track, 114 mm Range. Stainless Steel swivel, aluminum & plastic slide. Dims. 330x185x76mm (lxwxh). 3° Seat angle.



### Deck Mount Slide

**Item Code 069183**

12-Position Track. Range 114mm. Anodised aluminum and plastic material. Dims. 330x185x138mm (lxwxh). 3° Seat angle.



### Adjustable boat chair clamp

**Item Code 069182**

Universal application for fishing boats ("Jon boats") and canoes. Clamp adjustable from 200-483mm.  
Coated steel bracket. Complete with 360° swivel.

**Item Code 069370**

Economy fixed height pedestal 7". E-Coated steel. Standard 4-hole pattern. Square base and seat mount. Dims. 178 x 178 x 178mm (lxwxh). Hole pitch 140mm.

**Economy Fixed Height 7" Pedestal**



**Item Code 069371**

Economy fixed height pedestal 13". E-Coated steel. Standard 4-hole pattern. Square base and seat mount. Dims. 178 x 178 x 330mm (lxwxh). Hole pitch 140mm.

**Economy Fixed Height 13" Pedestal**



**Item Code 069195**

Belle Chair Pedestal  
Height adjustment: 330-430mm, 5 positions.  
360° Swivel with 4 locks.  
ØBase: 254mm.

**Belle / Belle Deluxe Chair Pedestals**

**Item Code 069495**

Belle Deluxe Chair Pedestal  
Height adjustment: 310-450mm, 6 positions.  
360° Swivel.  
Polished aluminum base, Ø254mm.

**Item Code 069375**

Regatta aluminum Pedestal Ø2-7/8" (73mm).  
Extra low: Height 4-1/2" (114mm). Round Base Ø9" (229mm).  
Complete with Trac-Lock 360° Swivel with Lock.  
ABYC Class H-31 AD rated.

**Regatta Pedestal with Trac-Lock Swivel**

**Item Code 069376** Base only

**Item Code 069377** Swivel only



**Item Code 069938** 228-305mm, Ø229mm **NEW**

**Item Code 069190** 381-508mm, Ø 229mm

**Item Code 069191** 381-508mm, Ø 305mm

**Item Code 069480** 420-580mm, Ø 305mm (extra height)

Exceeds ABYC H-31 Standard for Class AD or AP Applications.  
Power Assisted Height Adjustment, complete with slide.  
Energy absorbing urethane joint between base and tube.  
360° Swivel with 1 lock. Convenient operating handles for height and slide adjustment. Anodised aluminum & stainless steel construction.  
(slide only: Item Code 069193)

**Mainstay Heavy Duty Adjustable Pedestal**



**Item Code 069101**

Exceeds ABYC H-31 Standard for Class AD or AP Applications.  
Complete with slide. Energy absorbing Urethane joint between base and tube. (Ø229mm). 360° Swivel with 1 lock.  
Anodised aluminum & stainless steel construction. H=460mm.

**Mainstay Heavy Duty Pedestal**



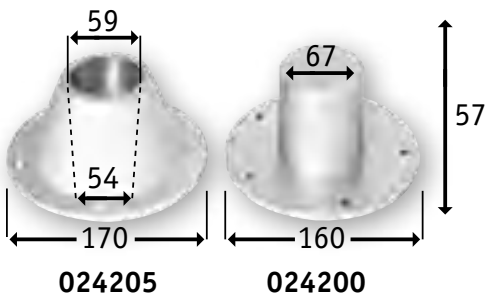

**Table Pedestal**

**Removable aluminum table pedestal**  
 Tube, base and table support

- Item Code 024200** Base (built in)
- Item Code 024205** Table support
- Item Code 024210** Pedestal 600mm, ø55mm
- Item Code 024215** Pedestal 700mm, ø55mm



**Orion Adjustable Table Pedestal With Slide**

**Item Code 069155**  
 With Gas Powered Cylinder.  
 Height Adjustment 355-675mm.  
 Base Ø305mm. 360° Swivel.  
 Requires 190mm under deck mounting space.  
 Anodised aluminum material.



**Twist Lock Table Pedestal**

**Item Code 069150** Table pedestal complete with base  
**Item Code 069151** Extra base  
 Placing or Removal in seconds. Very flat base:  
 no need to cut a hole in the deck. Features a locking table  
 mount assembly.  
 Height 686mm. Base Ø178mm, H=16mm,  
 Mounting Pattern 146mm. Adjustable 550-720mm,  
 6 steps. Anodised aluminum material.



**Tristar Adjustable Table Pedestal with flat base**

**Item Code 069194**  
 Very stable table pedestal of polished aluminum.  
 3-Stage air power adjustable from 335 to 714mm.  
 360° swiveling.  
 Table support head 320x320mm.  
 Base Ø12" (300mm) , tube Ø4" (102mm).  
 Lift pressure: 18kg.  
 Holding capacity: 82kg with clamps engaged.



### Plastic table with Thread-Lock Pedestal

Table Package Plastic table top with aluminum pedestal and surface mount base. Easy to install and to remove due to quick connect system. Height = 27" (686mm). Height with Table Top 750mm.

**Item Code 069192** Set with Round Table Top, Ø24" (610mm)

**Item Code 069446** Set with Oval Table Top, 18"x30"  
(457x762mm)

**Item Code 069447** Set with Rectangular Table Top, 16"x28"  
(406x711mm)

**Item Code 069151** Aluminum surface mount base, Ø230mm

### Plastic Table with Thread-Lock Pedestal

**Item Code 069492** "Party Platter" Table Package

Plastic table top with drink holders. With aluminum pedestal and surface mount base. Easy to install and to remove due to quick connect system. Table 450x390mm.

Height = 27" (686mm). Height with Table Top 750mm.

### Plastic Tables with Aluminum Pedestal and Base



Solid teak table tops

**Item Code 369001** 370 x 600mm.

Material thickness minimum 25mm

**Item Code 369002** 450 x 700mm.

Material thickness minimum 25mm

**Item Code 369003** 550 x 800mm.

Material thickness minimum 25mm

**Item Code 369005** Round Ø610.

Material thickness minimum 23mm

### Teak Table tops

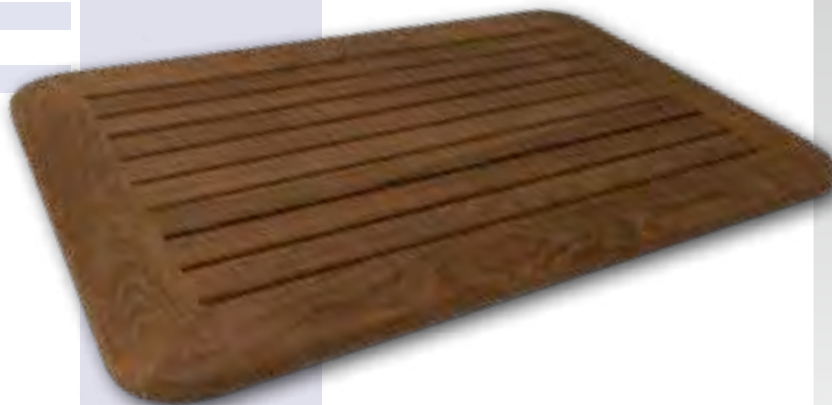

Thread-Lock Pedestal 27" (686mm) with aluminum pedestal and surface mount base. Easy to install and to remove due to quick connect system.

**Item Code 369091** Thread-Lock Pedestal 686mm,  
Teak table top 370 x 600mm

**Item Code 369092** Thread-Lock Pedestal 686mm,  
Teak table top 450 x 700mm

**Item Code 369093** Thread-Lock Pedestal 686mm,  
Teak table top 550 x 800mm

**Item Code 369095** Thread-Lock Pedestal 686mm,  
Teak table top Ø610mm

**Item Code 069151** Aluminum base surface  
mount Ø230mm

### Teak tables with pedestal and base



069176



069175



**Stand-Up  
Seat**

**Pro Stand-Up Bicycle Style Plastic Seat**

- Item Code 069175** Pro Stand-Up seat, grey color
- Item Code 069176** Pro Stand-Up seat, black color

**Control Post Seat**

From a completely flat position to 90° upright, the Control Post Seat adjusts in every direction. Suitable for King-Pin, Plug-In, Spring-Lock and Taper-Lock serie.

- Item Code 069465** King-Pin, charcoal grey seat
- Item Code 069466** Plug-In, charcoal grey seat
- Item Code 069467** Spring-Lock, charcoal grey seat
- Item Code 069468** Taper-Lock, charcoal grey seat

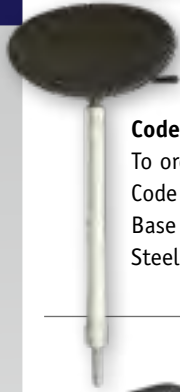

**Code 069465 (King-Pin)**  
To order separately:  
Code 069472 Built-in  
Base 178x178mm  
Steel, Satin Finish

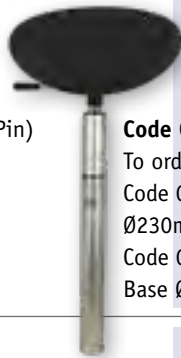

**Code 069466 (Plug-In)**  
To order separately:  
Code 069186 Built-in Base  
Ø230mm Aluminum  
Code 069424 Surface Mount  
Base Ø230mm Aluminum

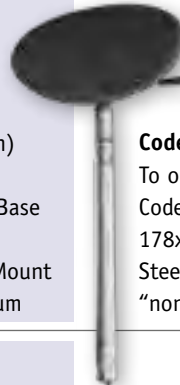

**Code 069467 (Spring-Lock)**  
To order separately:  
Code 069477 Built-In Base  
178x178mm  
Steel, Satin Finish  
"non locking"

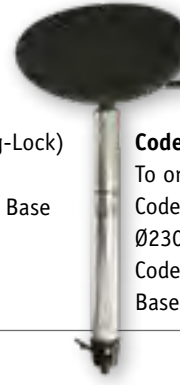

**Code 069468 (Taper-Lock)**  
To order separately:  
Code 069161 Built-In Base  
Ø230mm Aluminum  
Code 069162 Surface Mount  
Base Ø230mm Aluminum



069435



069470

**KingPin Hi-Lo 3-Piece Package, 13-1/2"**

**Item Code 069470**

Threaded KingPin Hi-Lo Set.

In the High position, the pedestal is a comfortable fishing seat. Remove the post and insert the seat mount into the base for the Low position. Post is 11", swivel adds 3-1/2" to the height.

This set consists of:

- Item Code 069471** Threaded fixed height Aluminum Post, satin finish
- Item Code 069435** Threaded Seat Mount with Spring, E-Coated Steel
- Item Code 069472** Threaded Square Stainless Steel base 7"x7" (178x178mm), satin finish  
Seat must be ordered extra.

069471



069473



069472

**KingPin Threaded Power-Rise Sit Down Pedestal 16" to 22", 360°**

**Item Code 069473**

Aluminum Pedestal 16" to 22-3/8" (406 to 568mm), satin finish. Base and seat must be ordered extra.

**Item Code 069472**

Threaded Square Stainless Steel Base 7"x7" (178x178mm), satin finish.



**Taper- Lock  
Serie**

**Taper-Lock Power-Rise Stand-Up Package 22-1/2" to 29-1/2", 360°**

**Item Code 069414**

Aluminum Pedestal 22-1/2" to 29-1/2" (571 to 749mm), satin finish. Complete with Quick-Tilt Seat Mount.

Tilts in 4 snap-in angles: 0°, 30°, 60°, 90°

Base and seat must be ordered extra.

**Taper-Lock Power-Rise Sit-Down Pedestal 13" to 19-1/8"**

**Item Code 069166**

Aluminum Power-Rise Sit-Down Pedestal 13" to 19-1/8" (330 to, 486mm), satin finish.

Base and seat must be ordered extra.

**Item Code 069161**

Aluminum Round Shaped In-Deck Taper-Lock Base Ø9" (229mm) satin finish. 8" (203mm) hole pattern. Requires 3-1/2" (89mm) hole in deck.

**Item Code 069162**

Aluminum Round Shaped Surface Mount Taper-Lock base Ø9" (229mm), satin finish. 8" (203mm) hole pattern.

**Plug-In Hi-Lo 3-onderdelen Package, 15"**

**Item Code 069187**

Unique "2-position" pedestal with plug-in feet.  
High position for fishing, low position for navigating.  
Complete with 360° swivel. H=381mm max., 70mm min.

Bicycle style seat needs to be ordered extra.



**Plug-In  
"HI-LO"  
pedestal-kit**

Complete aluminum telescopic plug-in pedestal kit with bicycle style seat, telescopic Ø60mm pedestal with gas power cylinder/shock absorber, 360° swivel and plug-in base.

**Item Code 069188-S**

Low pedestal kit  
Height adjustment 432-603mm (incl. seat)

**Item Code 069189-S**

High pedestal kit  
Height adjustment 635-800mm (incl. seat)

Separate parts:

- Item Code 069188** Low Pedestal, 362-533mm
- Item Code 069189** High Pedestal, 565-730mm
- Item Code 069175** Pro Fishing Bicycle Style Seat made of grey waterproof marine vinyl
- Item Code 069186** Aluminum Plug-In base Ø230mm Built-in depth 60mm, built-in Ø73mm
- Item Code 069424** Aluminum Plug-in base Ø230mm, surface mount



**Plug-In  
AIR RIDE  
Telescopic  
fishing chair and  
pedestal  
package**



**Item Code 069475**

Stainless Steel Polished Finish Spring-Lock Sit-Down Pedestal.  
Adjustable Height from 13-1/2" to 20" (343-508mm).  
3° Tilt cast aluminum swivel rotates 360°. AYBC Class H-31 B.  
A push of the button and the latch unlocks the post from the base.

**Item Code 069476**

Stainless Steel Polished Finish Spring-Lock Stand-Up Pedestal.  
Adjustable Height from 25-1/2" to 32-1/4" (648-820mm).  
3° Tilt cast aluminum swivel rotates 360°. AYBC Class H-31 B.  
A push of the button and the latch unlocks the post from the base.

**Base and Seat needs to be ordered extra:**

**Item Code 069175**

Pro Fishing Bicycle Style Seat made of grey waterproof marine vinyl.

**Item Code 069477**

Stainless Steel Satin Finish Non-Locking Square Base.  
7" x 7" (178x178mm).



**Spring-Lock  
Telescopic  
Pedestal**

069475

069476

069477



124501/11



124502/12



124503/13



124504/14



124505



124506/16



124500 (standard supply)

**Accessories**

**Ø 20MM:**

Item Code 124501 Nylon bushing

Item Code 124502 Nylon hinge end fitting, tube side

Item Code 124503 Nylon "row lock"- attachment Ø12mm

Item Code 124504 Nylon "row lock"- attachment (pin)  
Ø11,5mm, gap 5mm

Item Code 124505 Attachment for inflatable boat (Ø 20 and 25mm)

Item Code 124506 Nylon slide hinge fitting

**Ø 25MM:**

Item Code 124511 Nylon bushing

Item Code 124512 Nylon hinge end fitting, tube side

Item Code 124513 Nylon "row lock"- attachment Ø12,7mm

Item Code 124514 Nylon "row lock"- attachment (pin)  
Ø12mm, gap 7mm

Item Code 124505 Attachment for inflatable boat (Ø 20 and 25mm)

Item Code 124516 Nylon slide hinge fitting

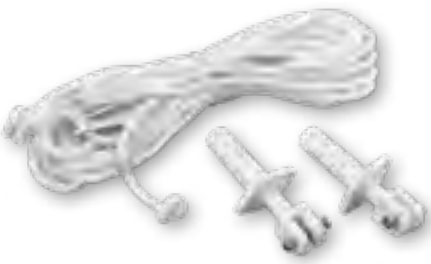

080126



080106  
Ø20 x Ø25mm



080109  
Ø11.7 x Ø16.7mm



art. 078980  
Also see page 283



art. 072660



080117



080107  
Ø25mm



080108  
Ø11.5mm



080120



080110  
Ø11mm

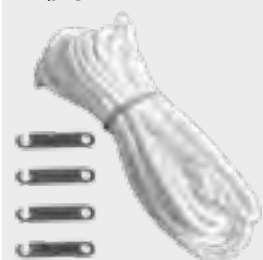

080128



080111  
(1x, L=1050mm)



072170  
73x48mm Lxb  
Ø18.7mm



080122 Ø22mm

080123 Ø25mm

080124 Ø30mm

080112  
(1x, L=1050mm)

080103  
(1x, L=1050mm)

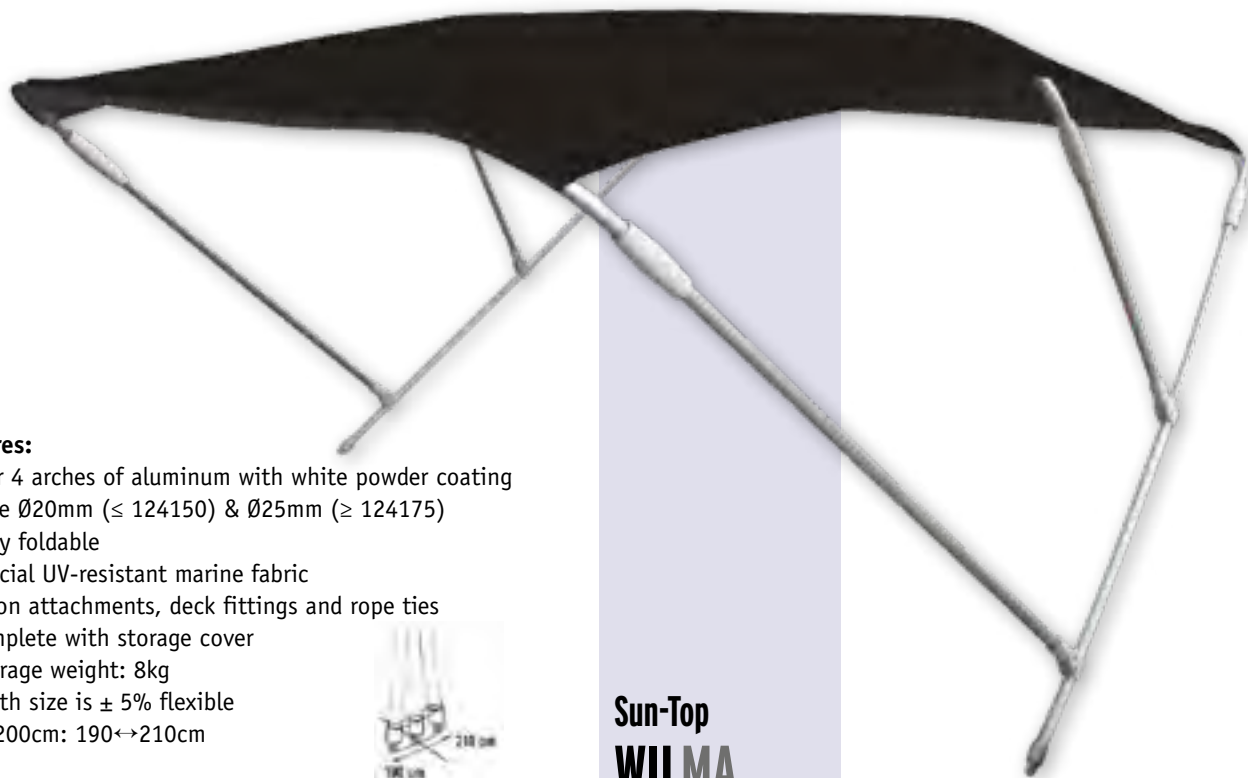

Sun-Top  
WILMA

Features:

- 3 or 4 arches of aluminum with white powder coating
- Tube Ø20mm (≤ 124150) & Ø25mm (≥ 124175)
- Fully foldable
- Special UV-resistant marine fabric
- Nylon attachments, deck fittings and rope ties
- Complete with storage cover
- Average weight: 8kg
- Width size is ± 5% flexible  
At 200cm: 190↔210cm



Item C. Navy	Item C. Black	Width cm	Height cm	Length cm	Arches
124110	124310	110	110	180	3 Ø20mm
124130	124330	130	110	180	3 Ø20mm
124150	124350	150	110	180	3 Ø20mm
124175	124375	175	150	255	4 Ø25mm
124200	124400	200	150	255	4 Ø25mm
124225	124425	225	140	255	4 Ø25mm
124240	124440	240	140	255	4 Ø25mm
124255	124455	255	140	255	4 Ø25mm
124270	124470	270	140	260	4 Ø25mm
124295	124495	295	130	260	4 Ø25mm



Pair of brackets for Sun-Top

- Item C. 124550 "WILMA - Ø20mm"
- Item C. 124555 "WILMA - Ø25mm"



124500 (standard supply)



Accessories



124501/11



124502/12



124503/13



124504/14



124505



124506/16

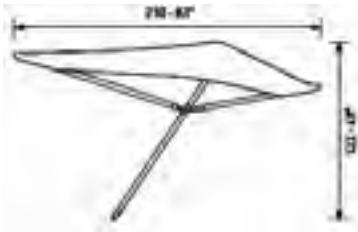

Sun-Top  
**ARIA**

Standard included:  
Item Code 080126  
Item Code 080117

**Features:**

- 3 Arches frame of AISI 316L stainless steel
- Tube Ø22 (≤ 080192) & Ø25mm (≥ 080193)
- New Design,
- Top cover made of Marine-Polacryl®, vinyl coated
- Joints and deck fittings of stainless steel
- Rope fixing ties with stretchers and fittings of stainless steel
- Complete with storage cover
- Folded dimensions: Width size x 15 x 126cm
- Average weight: 14kg
- Width size ± 5% flexible.  
At 200cm: 190↔210cm



080126



080117

Item C. <i>White</i>	Item C. <i>Navy</i>	Width cm	Height cm	Length cm
080190	080190/B	150	122	200
080191	080191/B	170	122	200
080192	080192/B	185	122	200
080193	080193/B	200	122	200
080194	080194/B	215	122	215
080195	080195/B	230	122	235
080196	080196/B	245	122	235



art. 078980

Also see page 283



art. 072660



080107  
Ø25mm

080106  
Ø20 x Ø25mm



080109  
Ø11.7 x Ø16.7mm



080120



080108  
Ø11.5mm



080110  
Ø11mm

**Additional accessories**



## Sun-Top BIMINOX

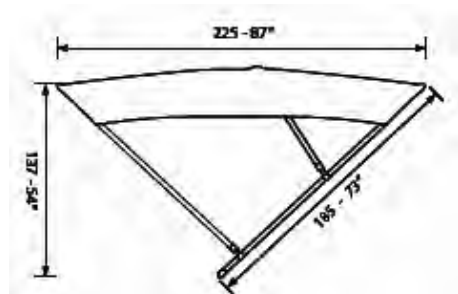

### Features:

- 3 Arches frame of AISI 316L stainless steel
- Ø 22mm Tubing
- Top cover made of Marine-Polacryl®, vinyl coated
- Joints and deck fittings of stainless steel
- Rope fixing ties with stretchers and fittings of stainless steel
- Complete with storage cover
- Folded dimensions: Width size x 15 x 175cm
- Average weight: 14kg
- Width size ± 5% flexible.  
At 200cm: 190↔210cm



Standard included:  
Item Code 080126  
Item Code 080117

Item C. Navy	Item C. Black	Width cm	Height cm	Length cm
080170	080170/Z	170	140	200
080171	080171/Z	185	140	200
080172	080172/Z	200	140	200
080173	080173/Z	215	140	215
080174	080174/Z	230	145	230
080175	080175/Z	245	145	245



080126



080117

Pair of brackets for Sun-Top  
Item Code 080116 "BIMINOX - Ø22mm"



080128

080112  
(1x, L=1050mm)



080103  
(1x, L=1050mm)



080111  
(1x, L=1050mm)



072170  
73x48mm lxb  
Ø18.7mm



080122 Ø22mm  
080123 Ø25mm  
080124 Ø30mm

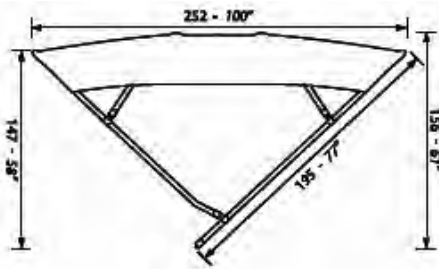

Sun-Top  
**FLYINOX**

**Features:**

- 4 Arches frame of AISI 316L stainless steel
- Ø 25mm Tubing
- Top cover made of Marine-Polacryl®, vinyl coated
- Joints and deck fittings of stainless steel
- Rope fixing ties with stretchers and fittings of stainless steel
- Complete with storage cover
- Folded dimensions: Width size x 20 x 200cm
- Average weight: 22kg
- Width size ± 5% flexible.  
At 200cm: 190↔210cm



**Standard included:**  
Item Code 080126  
Item Code 080119



080126



080119

Item C. <i>Beige</i>	Item C. <i>Navy</i>	Item C. <i>White</i>	Width cm	Height cm	Length cm
380380	380360	380370	170	156	252
380381	380361	380371	185	156	252
380382	380362	380372	200	156	252
380383	380363	380373	215	156	252
380384	380364	380374	230	156	252
380385	380365	380375	245	156	252
380386	380366	380376	255	156	252
380387	380367	380377	270	156	252
380388	380368	380378	285	156	252
380389	380369	380379	300	156	252



art. 078980  
Also see page 283



080117



080107  
Ø25mm

080106  
Ø20 x Ø25mm



080109  
Ø11.7 x Ø16.7mm



080108  
Ø11.5mm



080120



080110  
Ø11mm

**Additional accessories**



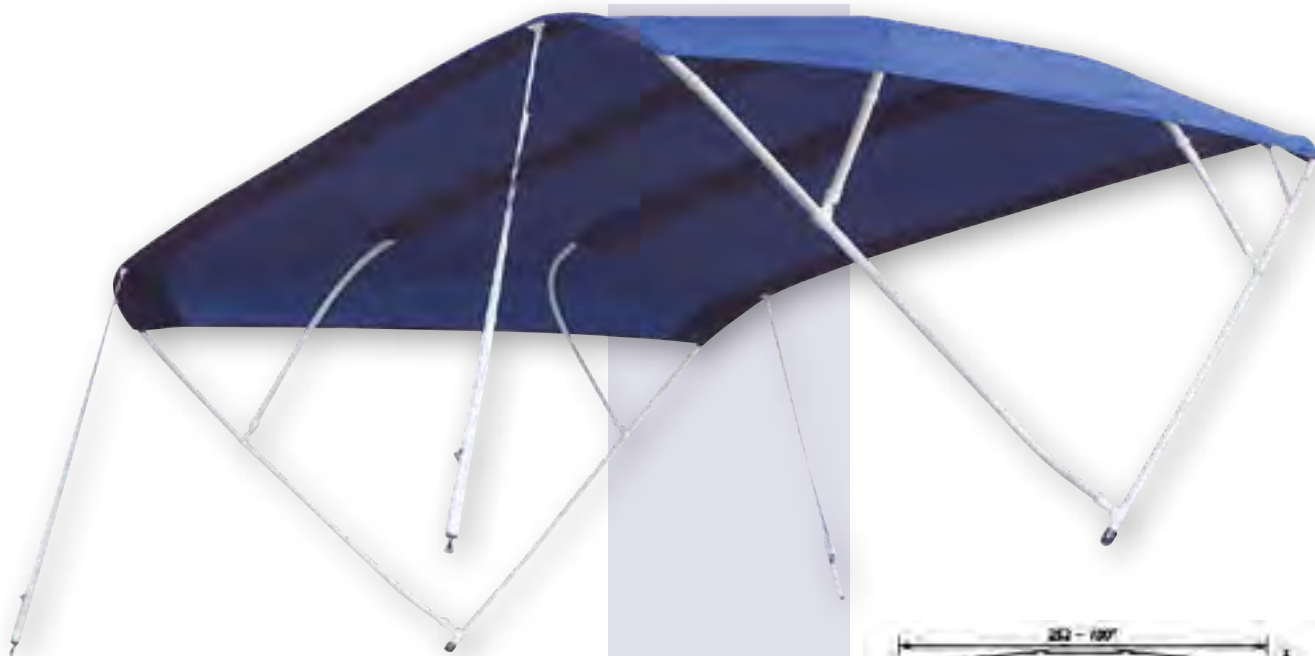

## Sun-Top SIXTY

### Features:

- 4 Arches frame of aluminum/magnesium alloy
- Ø 25mm Tubing
- Top cover made of Marine-Polacryl®, vinyl coated
- Joints and deck fittings of stainless steel
- Rope fixing ties with stretchers and fittings of stainless steel
- Complete with storage cover
- Folded dimensions: Width size x 30 x 200cm
- Average weight: 12kg
- Width size ± 5% flexible.  
At 200cm: 190↔210cm

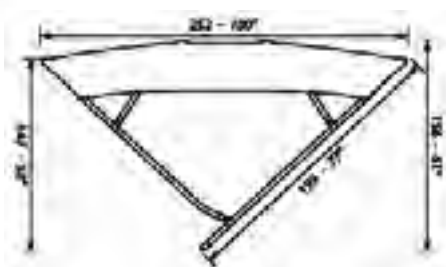

Standard included:  
Item Code 080126  
Item Code 080117

Item C. Navy	Item C. White	Width cm	Height cm	Length cm
080050	080050/W	175	156	252
080051	080051/W	200	156	252
080052	080052/W	230	156	252
080053	080053/W	245	156	252
080054	080054/W	255	156	252
080055	080055/W	270	156	252
080056	080056/W	300	156	252



080126



080117



### Pair of brackets for Sun-Top

Item Code 080125 "FLYINOX - Ø25mm"

Item Code 080115 "SIXTY - Ø25mm"



080128

080112  
(1x, L=1050mm)



080103  
(1x, L=1050mm)

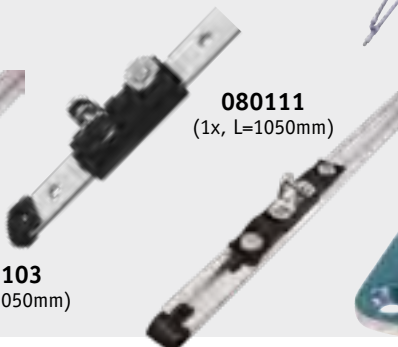

080111  
(1x, L=1050mm)



072170  
73x48mm lxb  
Ø18.7mm



080122 Ø22mm  
080123 Ø25mm  
080124 Ø30mm



**Pressure Gauge**

**Item Code 026051** Pressure Gauge for 026004 & 026006

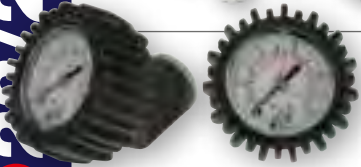

**Hand Pressure Gauge**

**Item Code 026055**  
Hand Gauge for checking the pressure of inflatable boats.



**Super Pumps for Rubber Boats**

Double action Pump. In order to reduce muscular strain, it is possible to switech from double to single action. Pumps are designed for inflating and deflating. Supplied with hose and 6 universal fittings. Pressure Gauge optional.

**Item Code 026004** Air Pump Super - Type 4-2 (4 Litre).  
**Item Code 026006** Air Pump Super- Type 6-3 (6 Litre).



**Electric Inflator**

**Item Code P0218544**  
Inflator 12V  
ABS Housing. With cigarette lighter plug and air hose adapters



**allpa XXL Electric Inflator 230V**

**Item Code 580500**  
Extremely powerful and fast air pump with a capacity of 3000 l/min. The pump blows and sucks.

Engine: 220/240V 1000W  
capacity: 3000 l/min  
Pressure: 3.6 psi



**Bravo BP Electric Inflator**

**Bravo BP Electric Inflator 12V without battery kit**

Item Code	580380
Piston flow rate	120 l/min
Max pressure	1 bar (14.5 psi)
Voltage/Ampere	12V/13A
Dims incl shoulder bag	21 x 20 x 13 cm
Air hose	1.70m

**Code 580330 Bravo BP Electric Inflator 12V complete with battery kit**

Suitable for dinghy, SUP, kites etc. Pump stops automatically when the preset pressure is reached. Complete with multiple connection nipples.



026052

Item Code	580348
Piston flow rate	125 l/min
Max pressure	1.5 bar (22 psi)
Voltage	12V or external battery (battery clamps included)
Dims incl shoulder bag	20 x 32 x 22 cm
Weight	6.65 kg

Suitable for dinghy, SUP, kites etc.

**GE20**  
**Electric pump**  
**12V**



Item Code	580344
Piston flow rate	160-450 l/min adjustable
Max pressure	0.95 bar (13.8 psi)
Voltage	12V
Dimension	29 x 10 x 15 cm
Weight	6.65 kg
Air hose	1.70m

Suitable for dinghy, SUP, kites etc. Pump stops automatically when the preset pressure is reached. Complete with multiple connection nipples.

**GE BTP**  
**Electric pump**  
**12V**



Item Code	580342
Piston flow rate	1000 l/min
Max pressure	0.25 bar (3.6 psi)
Voltage	12V
Dimension	31 x 18 x 19 cm
Weight	3.55 kg
Air hose	3 m

**Code 580343 to be permanently installed on board**

Suitable for dinghy, SUP, kites etc. Pump stops automatically when the preset pressure is reached. Complete with multiple connection nipples.

**Bravo Turbo Max**  
**Electric Inflator**  
**12V**



Item Code	580345
Piston flow rate	450 l/min
Max pressure	0.30 bar (4.4 psi)
Voltage	12V or external battery (battery clamps included)
Dimension	18 x 20 x 24 cm
Weight	1.9 kg
Air hose	3 m

Suitable for dinghy, SUP, kites etc. Pump stops automatically when the preset pressure is reached. Complete with multiple connection nipples.

**Bravo**  
**Super Turbo**  
**BST 300**  
**12V**



Item Code	580347
Piston flow rate	450 l/min
Max pressure	0.80 bar (11.6 psi)
Voltage	12V or external battery (battery clamps included)
Dimension	18 x 20 x 24 cm
Weight	1.9 kg
Air hose	3 m

Suitable for dinghy, SUP, kites etc. Pump stops automatically when the preset pressure is reached. Complete with multiple connection nipples.

**Bravo**  
**Super Turbo**  
**BST**  
**12V**





## 2-Components repair kits

### 2-Components repair kit for PVC boats

#### Item Code 061100

Kit consists of:

- 125 ml glue
- 10 ml of activating agent
- 10 ml cleaning agent
- 1 brush
- 1 piece of PVC material, round, light grey
- 1 set of protective gloves

### 2-Components repair kit for neoprene-hypalon boats

#### Item Code 061105

Kit consists of:

- 125 ml glue
- 10 ml of activating agent
- 1 piece of sandpaper
- 1 brush
- 1 piece of neoprene-hypalon material, round, light grey
- 1 set of protective gloves



## 2-Components PVC-glue

### 2-Components glue for PVC boats

#### Item Code 061120

Kit consists of:

- 500gr glue
- 30ml activator
- 1 set of protective gloves



## Snap Davits



#### Item Code 01700036

Snap Davits set for Tender. To be mounted on the bridge or directly on the transom. Release type fastener made of stainless steel. The counter brackets are made of **neoprene** and must be glued on the inflatable boat. Complete set. Suitable for PVC and Neoprene.



## Drain Socket

#### Item Code N1423

With non-return-valve  
Ø Internal 35mm, Ø External 38mm  
Hole pitch 52mm, width 63mm



## Large Drain Socket

#### Item Code N208

With non return valve  
Dims. Ø 66 x 92mm



## Expanding Drain Plug

#### Item Code 008567

Ø35mm. Fits Item Codes N1423 en Item Code 062042 (Plastic skin fitting)



## Rubber Drain Plug

#### Item Code 008570

Ø35mm. Fits Item Code N1423



## Nylon Hook

Item Code 004799 Nylon Hook for Inflatable Boat Cover

**Couple of Launching Wheels**

for Rubber Boats & Small Polyester Boats. New Stainless Steel Execution. With inflatable tyres. max. weight 150kg. Price per set.

**Item Code 069305**

Set launching wheels type "Ibis" (big), removable

Spare inner tube = **069310**

Complete wheel = **069306**

**Item Code 069355**

Set launching wheels type "Ibis II" (small), folding

Spare inner tube = **069360**

Complete wheel = **069356**

**Launching Wheels**



**Item Code 00804080**

Set double folding launching wheels. Stainless Steel AISI 316

H=790mm. Wheel Ø260mm. Weight 6,8kg

Max. load 180kg

**Launching Wheels double**



**Couple of wheels**

**made of Stainless Steel and synthetic rubber**

Easy lifting when seagoing as well as an easy and safe falling into position when re-entering

**Item Code 00836062** Price per set Max. Weight 100kg

Wheel ø360mm

(Spare wheel Item Code 069356)

**Item Code 00800080** Price per set (not folding)

Max. Weight 150kg, Wheel ø360mm

**Item Code 00836038** Max. Weight 100kg, for extended flaps

floor (p.e. Honda), Wheel ø260mm

**Item Code 00836080** Max. Weight 180kg with reinforcement

Wheel ø360mm

**Item Code 00804080** Launching Wheels folding

(3 positions) Solid plastic wheels,

Max. Weight 100kg 100x270mm (wxh).

Wheel Ø130mm

**Launching Wheels Special**



**Item Code 00836110**

To be attached to the bow grip on the boat. Made of zinc steel and comes with pneumatic tyres. A=360mm, B=490mm

Spare wheel with tyre = **01040000** C=940mm, D=1140mm

**Boat trolley**

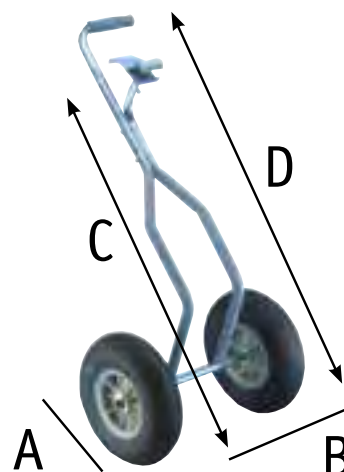



**Push-Push Inflatable Boat Valve**

**Item Code 026250**  
 Universal valve with „Push-push“ system: valve Remains open while deflating. Comes with bayonet connection fill adapters.  
 Dims.: outside 51 x 53 mm (W x H), inner Ø38 mm.



**Item Code 038702** valve for actual allpa and Lodestar boats 2014/15  
**Item Code 038702/W** valve for previous Allpa boats



**Item Code 038707**  
 Mounting key for inflatable boat valve. Suitable for all current allpa valves, also Lodestar, also valve item code 026250. Color black with 8 narrow notches.

**Item Code 038707/W**  
 Mounting key for inflatable boat valve for former allpa and Lodestar boats. Color gray with 6 wide notches.



**Item Code 038703** aluminum Oar (1x) L=168cm  
**Item Code 038715** aluminum Oar (1x) L=144cm



**Item Code 038704** repair kit PVC Boats, white  
**Item Code 038717** repair kit PVC Boats, dark blue



**Item Code 038705** adhesive tape for bench (white)  
**Item Code 038718** adhesive tape for bench (dark blue)

**Replacement parts allpa inflatable boats**

**Item Code 038706** oar locks (1x)  
**Item Code 038806** retaining Oar Lock Screw



**Item Code 038709** drain valve, ø22mm



**Item Code 038710** Aluminum bench L=100cm (easy to cut to measure if needed)  
**Item Code 038850** Aluminum bench L=85cm for 265, 295 & 330  
**Item Code 038853** Aluminum bench L=95cm for 350 & 390  
**Item Code 038854** Aluminum bench L=105cm for 420



**Item Code 038711** Air footpump  
**Item Code 038708** Air hose with quick connect fitting



Bag to fit under the seat of an inflatable boat. With seat cushion. Bag can be unzipped. Made of strong water-repellent material. Color: light grey

**Item Code 038855** Bag for bench length 75cm

**Item Code 038856** Bag for bench length 85cm

**Item Code 038857** Bag for bench length 95cm

**Item Code 038858** Bag for bench length 105cm

### Inflatable Boat Seat Bag



Bow Bag universal

Color: light grey

**Item Code 038885** Bow Bag for boat length 200-250cm

**Item Code 038886** Bow Bag for boat length 265-330cm

**Item Code 038887** Bow Bag for boat length 350-390cm

**Item Code 038888** Bow Bag for boat length 420cm

### Inflatable Boat Bow Bag



**Item Code 038960** Cover for boat length 230cm

**Item Code 038961** Cover for boat length 260/300cm

**Item Code 038962** Cover for boat length 340cm

Color: light gray

### Inflatable Boat Cover Heavy Duty



**Boat Cover Telescopic Support Pole** Prevents Flooding from Rain

**Item Code 1627497** Adjustable from 865 – 1515mm

**Item Code 080100** Adjustable from 900 – 1730mm can be stitched to the boat cover!

**Item Code 072009** Material: Aluminium, Anodized Tube

Tube Diameter: 25.4mm/28.8mm, Length: 790 - 1487mm

It features a top and base Solid Round Design which reduces skidding or movement of the pole

With webbing straps 2x10 M & plastic buckles

### Boat Cover Support Pole

072009

**NEW**

080100



Boat covers for a good protection of your boat.

Made of polyester 300D\* fabric with aluminum coating and D-rings for easy fixing.

Color Silver grey.

\* Size XXL is made of 600D polyester fabric with blue navy color.

Color Silver grey.

### Boat covers

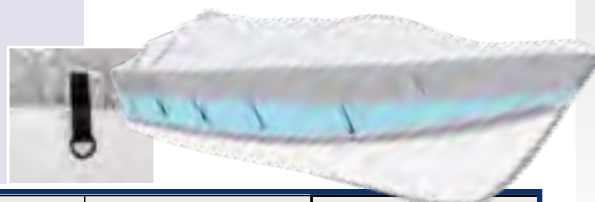

Item Code	Size	Boat length	Boat width	No. D-ring	Color
02224300	Tender	240-300	140	6	Silver grey
02230360	Tender	300-360	170	6	Silver grey
02218488	XXS	427-488	180	8	Silver grey
02222488	XS	427-488	229	10	Silver grey
02223488	S	488-564	239	10	Silver grey
02224579	M	518-579	244	10	Silver grey
02226610	L	550-610	265	10	Silver grey
02229650	XL	580-650	295	10	Silver grey
02238710	XXL	630-710	380	10	Blue Navy
02270780	Maxi	700-780	400	14	Blue Navy





	<b>SENS 240-alu</b>	<b>SENS 240-air</b>
	<b>Item Code 038435</b>	<b>Item Code 038436</b>
Floor Material	Aluminium	Air Deck-floor
Max hp	4hp	4hp
Capacity	350kg / 2 pers.	350kg / 2 pers.
Weight	38kg	34kg
Ø Tube	37cm	35cm
Air Chambers	3 + 1	3 + 1
Long / short shaft	short shaft	short shaft
Outside dims.	235 x 137cm	235 x 137cm
Inside dims.	151 x 60cm	151 x 60cm



**allpa**  
marine equipment

	<b>SENS 265-alu</b>	<b>SENS 265-air</b>
	<b>Item Code 038440</b>	<b>Item Code 038480</b>
Floor Material	Aluminium	Air Deck-floor
Max hp	10hp	10hp
Capacity	484kg / 3,5 pers.	484kg / 3,5 pers.
Weight	49kg	37kg
Ø Tube	42cm	42cm
Air Chambers	3 + 1	3 + 1
Long / short shaft	short shaft	short shaft
Outside dims.	270 x 153cm	270 x 153cm
Inside dims.	174 x 68cm	174 x 68cm



	<b>SENS 290-alu</b>
	<b>Item Code 038450</b>
Floor Material	Aluminium
Max hp	10hp
Capacity	510kg / 4 pers.
Weight	51kg
Ø Tube	42cm
Air Chambers	3 + 1
Long / short shaft	short shaft
Outside dims.	290 x 155cm
Inside dims.	185 x 68cm





<b>SENS 330-alu</b>	
<b>Item Code 038460</b>	
Floor Material	Aluminium
Max hp	15hp
Capacity	566kg / 4,5 pers.
Weight	54kg
Ø Tube	42cm
Air Chambers	3 + 1
Long / short shaft	short shaft
Outside dims.	325 x 155cm
Inside dims.	212 x 68cm



**allpa**  
marine equipment

### Accessoires



Bench  
038207



Steering console  
038206





NSA-230/260



Ultra Light Drop-Stitch	Ultra Light 195	Ultra Light 220	Ultra Light 250	Ultra Light 275
	Item Code 038029	Item Code 038032	Item Code 038035	Item Code 038037
Floor Material	Air Deck-floor	Air Deck-floor	Air Deck-floor	Air Deck-floor
Package size (cm)				
Boat	95 x 40 x 25	95 x 45 x 25	95 x 65 x 28	95 x 70 x 30
Max hp	4	5	5	8
Long / short shaft	short shaft	short shaft	short shaft	short shaft
Max. People	2	3	3 + 1	4
Air Chambers	3 + 1 + 1	3 + 1 + 1	3 + 1 + 1	3 + 1 + 1
Ø Air Chambers (cm)	41	41	41	41
Dimensions (cm) AxB	195 x 143	220 x 143	250 x 143	275 x 143
Weight (kg) C	20	22	25	27

NSA	NSA 230	NSA 260	NSA 290	NSA 300	NSA 340
	Item Code 038003	Item Code 038006	Item Code 038009	Item Code 038010	Item Code 038014
Floor Material	Air Deck-floor	Air Deck-floor	Air Deck-floor	Air Deck-floor	Air Deck-floor
Package size (cm)					
Boat	100 x 55 x 30	100 x 60 x 35	100 x 55 x 28	110 x 65 x 35	110 x 70 x 40
Max hp	5	6	10	15	20
Long / short shaft	short shaft	short shaft	short shaft	short shaft	short shaft
Max. People	3	3 + 1	4	5	6
Air Chambers	3 + 1 + 1	3 + 1 + 1	3 + 1 + 1	3 + 1 + 1	3 + 1 + 1
Ø Air Chambers (cm)	41	41	41	45	45
Dimensions (cm) AxB	230 x 143	260 x 143	290 x 145	300 x 170	340 x 170
Weight (kg) C	29	32	34	41	48

NS	NS 250	NS 290	NS 320
	Item Code 038040	Item Code 038042	Item Code 038045
Floor Material	Polyester floor	Polyester floor	Polyester floor
Package size (cm)			
Boat / Floor	100x60x40 / 75x50x12	100x60x40 / 82x60x12	100x65x40 / 88x60x12
Max hp	6	10	15
Long / short shaft	short shaft	short shaft	short shaft
Max. People	3	4	5
Air Chambers	3 + 1	3 + 1	3 + 1
Ø Air Chambers (cm)	41	41	41
Dimensions (cm) AxB	250 x 152	290 x 152	320 x 152
Weight (kg) C	45	49	55

Ultra Light

NSA-300/340

NS



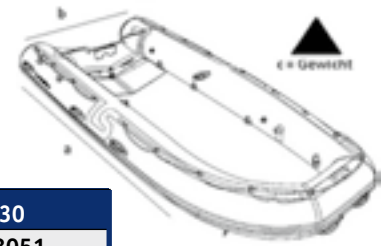

TriMAX 3D-V	TriMAX 3D-V 340	TriMAX 3D-V 380	TriMAX 3D-V 430
	<b>Item Code 038049</b>	<b>Item Code 038048</b>	<b>Item Code 038051</b>
Floor Material	3D-V air floor	3D-V air floor	3D-V air floor
Package size (cm)			
Boat	125 x 70 x 30	142 x 75 x 40	142 x 75 x 45
Max hp	20	30	50
Long / short shaft	short shaft	short shaft	short shaft
Max. People	6	8	10
Air Chambers	3 + 1 + 2	3 + 2 + 2	4 + 2 + 2
Ø Air Chambers (cm)	45	50	50
Dimensions (cm) AxB	340 x 170	380 x 200	430 x 200
Weight (kg) C	58	94	99

TriMAX ALU	TriMAX ALU 340	TriMAX ALU 380	TriMAX ALU 430
	<b>Item Code 038046</b>	<b>Item Code 038047</b>	<b>Item Code 038050</b>
Floor Material	Aluminum floor	Aluminum floor	Aluminum floor
Package size (cm)			
Boat / Floor	125x70x30 / 100x60x15	142x75x35 / 122x66x15	142x75x40 / 122x66x15
Max hp	20	30	50
Long / short shaft	short shaft	short shaft	short shaft
Max. People	6	8	10
Air Chambers	3 + 1 + 2	3 + 1 + 2	4 + 1 + 2
Ø Air Chambers (cm)	45	50	50
Dimensions (cm) AxB	340 x 170	380 x 200	430 x 200
Weight (kg) C	87	135	150

	RIB Light	RIB 260 Light	RIB 290 Light
		<b>Item Code 038055</b>	<b>Item Code 038060</b>
Floor Material		Polyester floor	Polyester floor
Package size (cm)			
Boat		215 x 100 x 45	240 x 105 x 45
Max hp		6	10
Long / short shaft		short shaft	short shaft
Max. People		3	4 + 1
Air Chambers		3	3
Ø Air Chambers (cm)		40	40
Dimensions (cm) AxB		260 x 154	295 x 154
Weight (kg) C		45	51

RIB Open	RIB 320 Open	RIB 350 Open	RIB 420 Open
	<b>Item Code 038062</b>	<b>Item Code 038065</b>	<b>Item Code 038067</b>
Floor Material	Polyester floor	Polyester floor	Polyester floor
Package size (cm)			
Boat	250 x 105 x 45	300 x 110 x 58	320 x 110 x 65
Max hp	20	30	40
Long / short shaft	short shaft	short shaft	long shaft
Max. People	4 + 1	6	7
Air Chambers	3	3	4
Ø Air Chambers (cm)	40	46	47
Dimensions (cm) AxB	320 x 159	350 x 170	420 x 180
Weight (kg) C	86	96	108





**allpa**  
marine equipment



## LEGEND

SI. = internal tank  
C. = Short shaft  
L. = Long shaft  
XL. = extra long shaft  
B. = Twist-grip

ST. = Control box  
DW. = Drive by Wire top mount  
E. = E-start  
T. = Tilt  
PT. = Power Trim

XSR = XSR engines have been specially developed by Selva Marine. These engines provide a torque boost compared to the base engines. Developed for better performance while maintaining efficiency and flexibility.

# Outboard Motors

## PORTABLE SERIES

	Guppy 2,5	Sea Bass 6	Ray 8	Piranha 9,9	Pike 9,9
Type	1-Cyl. 4-Stroke OHC	1-Cyl. 4-Stroke OHC	2-Cyl. 4-Stroke SOHC	1-Cyl. 4-Stroke OHC	2-Cyl. 4-Stroke SOHC
Displacement	87 cc	118 cc	197 cc	181 cc	212 cc
Bore x stroke	54 x 38 mm	56 x 48 mm	56 x 40 mm	66 x 53 mm	56 x 43 mm
Fuel system	carburetor	carburetor	carburetor	carburetor	carburetor
Power	2,5 hp / 1,84 kW	6 hp / 4,4 kW	8 hp / 5,9 kW	9,9 hp / 7,3 kW	9,9 hp / 7,3 kW
Max. number of revs.	4500 - 5500 rpm	5000 - 5500 rpm	4000 - 5000 rpm	5500 - 6000 rpm	5000 - 6000 rpm
Weight	13,5 kg	23 kg	37 kg	30,5 kg	39,9 kg
Starter	Manual	Manual	Manual / E-Start	Manual / E-Start	Manual / E-Start
Generator			12 V / 70 W	12 V / 70 W	12 V / 80 W
Control	Twist-grip	Twist-grip	Twist-grip / Control box	control box	Twist-grip / Control box
Direction reversal	A/R/360°	A/F/R/360°	A/F/R	A/F/R	A/F/R
Fuel tank	0,9 L internal	1,6 L internal	12 l separate	12 l separate	12 l separate
Shaft length	C.	C.	C. / L.	C. / L. / XL.	C. / L.
Transom height	381 mm	381 mm	381 / 508 mm	381 / 508 / 635 mm	381 / 508 mm
Version	Code				
		058397 SI.C.	058344 SI.C.	058405 C.	058365 C.
				058406 L.	058370 E.ST.L.
				058398 E.B.C.	058373 SAIL E.ST.XL.
				058399 E.B.L.	058407 C.
					058408 L.
					058409 E.ST.C.
					058412 E.ST.L.



## PORTABLE SERIES

## MID-RANGE SERIES

	Wahoo 15	Wahoo 15 XSR	Amberjack 15 XS	Aruana 15 XS
Type	2-Cyl. 4-Stroke SOHC	2-Cyl. 4-Stroke SOHC	2-Cyl. 4-Stroke SOHC	3-Cyl. 4-Stroke SOHC
Displacement	362 cc	362 cc	432 cc	747 cc
Bore x stroke	63 x 58,1 mm	63 x 58,1 mm	65 x 65,1 mm	65 x 75 mm
Fuel system	carburetor	carburetor	EFI	EFI
Power	15 hp / 11 kW	15 hp / 11 kW	15 hp / 11 kW	15 hp / 11 kW
Max. number of revs.	5000 - 6000 rpm	5000 - 6000 rpm	5000 - 6000 rpm	5000 - 6000 rpm
Weight	51,7 kg	51,7 kg	56 kg	99 kg
Starter	Manual / E-Start	Manual / E-Start	Manual / E-Start	E-Start
Generator	12 V / 120 W	12 V / 120 W	12 V / 190 W	12 V / 190 W
Control	Twist-grip / Control box	Twist-grip / Control box	Twist-grip / Control box	Control box
Direction reversal	A/F/R	A/F/R	A/F/R	A/F/R
Fuel tank	12 l separate	23 l separate	23 l separate	23 l separate
Shaft length	C. / L.	C. / L.	C. / L.	L.
Transom height	381 / 508 mm	381 / 508 mm	381 / 508 mm	508 mm
Version Code	058423 C.	058320 C.	058528 C.	058449
	058413 L.	058321 L.	058530 E.ST.L.PT	E.ST.L.PT
	058414 E.B.L.	058322 E.ST.C.		
	058415 E.ST.C.	058324 E.ST.L.T.		
	058424 E.ST.L.			



## MID-RANGE SERIES

	Wahoo 20	Amberjack 25	Aruana 40
Type	2-Cyl. 4-Stroke SOHC	2-Cyl. 4-Stroke SOHC	3-Cyl. 4-Stroke SOHC
Displacement	362 cc	432 cc	747 cc
Bore x stroke	63 x 58,1 mm	65 x 65,1 mm	65 x 75 mm
Fuel system	carburetor	EFI	EFI
Power	20 hp / 14,7 kW	25 hp / 18,4 kW	40 hp / 29,4 kW
Max. number of revs.	5000 - 6000 rpm	5000 - 6000 rpm	5000 - 6000 rpm
Weight	52,7 kg	56 kg	99 kg
Starter	Manual / E-Start	E-Start	E-Start
Generator	12 V / 120 W	12 V / 190 W	12 V / 190 W
Control	Twist-grip / Control box	Twist-grip / Control box	Twist-grip / Control box
Direction reversal	A/F/R	A/F/R	A/F/R
Fuel tank	12 l separate	23 l separate	23 l separate
Shaft length	C. / L.	C. / L.	L.
Transom height	381 / 508 mm	381 / 508 mm	508 mm
Instruments			Digital - Multi functional
Version	Code		
	058416 C.	058520 C.	058445 E.B.L.
	058417 L.	058521 L.	058446 E.ST.L.PT
	058418 E.ST.C.	058522 E.ST.C.	
	058426 E.ST.L.	058523 E.ST.L.	
	058427 E.ST.L.T.	058524 E.ST.L.PT.	



## MID-RANGE SERIES

	Dorado 50	Dorado 60	Dorado 60 XSR	Murena 70	
Type	4-Cyl. 4-Stroke SOHC	4-Cyl. 4-Stroke SOHC	4-Cyl. 4-Stroke SOHC	4-Cyl. 4-Stroke SOHC - 16V	
Displacement	996 cc	996 cc	996 cc	996 cc	
Bore x stroke	65 x 75 mm	65 x 75 mm	65 x 75 mm	65 x 75 mm	
Fuel system	EFI	EFI	EFI	EFI	
Power	50 hp / 36,8 kW	60 hp / 44,1 kW	60 hp / 44,1 kW	70 hp / 51,5 kW	
Max. number of revs.	5000 - 6000 rpm	5000 - 6000 rpm	5000 - 6000 rpm	5300 - 6300 rpm	
Weight	111 kg	111 kg	111 kg	119 kg	
Starter	E-Start	E-Start	E-Start	E-Start	
Generator	12 V / 200 W	12 V / 200 W	12 V / 200 W	12 V / 200 W	
Control	Control box	Control box	Control box	Control box	
Direction reversal	A/F/R	A/F/R	A/F/R	A/F/R	
Fuel tank	23 l separate	23 l separate	23 l separate	23 l separate	
Shaft length	L.	L.	L.	L.	
Transom height	508 mm	508 mm	508 mm	508 mm	
Instruments	Digital - Multi functional	Digital - Multi functional	Digital - Multi functional	Digital - Multi functional	
Version	Code	058455 E.ST.L.PT.	058465 E.ST.L.PT.	058466 E.ST.L.PT.	058470 E.ST.L.PT.





## LARGE-ENGINE SERIES

	Spearfish 100	Spearfish 100 XSR	Swordfish 115	Swordfish 115 XSR
Type	4-Cyl. 4-Stroke SOHC - 16V	4-Cyl. 4-Stroke SOHC - 16V	4-Cyl. 4-Stroke SOHC - 16V	4-Cyl. 4-Stroke SOHC - 16V
Displacement	1832 cc	1832 cc	1832 cc	1832 cc
Bore x stroke	81 x 88,9 mm	81 x 88,9 mm	81 x 88,9 mm	81 x 88,9 mm
Fuel system	EFI	EFI	EFI	EFI
Power	100 hp / 73,5 kW	100 hp / 73,5 kW	115 hp / 84,6 kW	115 hp / 84,6 kW
Max. number of revs.	5000 - 6000 rpm	5000 - 6000 rpm	5300 - 6300 rpm	5300 - 6300 rpm
Weight	162 kg	162 kg	173 kg	173 kg
Starter	E-Start	E-Start	E-Start	E-Start
Generator	12 V / 350 W	12 V / 350 W	12 V / 420 W	12 V / 420 W
Control	Control box	Control box	Control box	Control box
Direction reversal	A/F/R	A/F/R	A/F/R	A/F/R
Shaft length	L.	L.	L. / XL.	L. / XL.
Transom height	508 mm	508 mm	508 / 635 mm	508 / 635 mm
Instruments	Double digital - Multi functional	Double digital - Multi functional	Double digital - Multi functional	Double digital - Multi functional
Version	Code	Code	Code	Code
	058505 E.ST.L.PT.	058508 E.ST.L.PT.	058500 E.ST.L.PT. 058501 E.ST.XL.PT.	058502 E.ST.L.PT. 058503 E.ST.XL.PT.



## BIG-ENGINE SERIES

	Killer Whale 150	Killer Whale 150 XSR	Sei Whale 200
Type	4-Cyl. 4-Stroke SOHC - 16V	4-Cyl. 4-Stroke SOHC - 16V	4-Cyl. 4-Stroke - 16V - DOHC with VCT
Displacement	2670 cc	2670 cc	2785 cc
Bore x stroke	94 x 96,2 mm	94 x 96,2 mm	96 x 96,2 mm
Fuel system	EFI	EFI	EFI
Power	150 hp / 110,3 kW	150 hp / 110,3 kW	200 hp / 147,1 kW
Max. number of revs.	5000 - 6000 rpm	5000 - 6000 rpm	5000 - 6000 rpm
Weight	216 kg	216 kg	227 kg
Starter	E-start	E-start	E-start
Generator	12 V / 420 W	12 V / 420 W	12 V / 500 W
Control	controlbox	controlbox	Drive by wire electronic
Direction reversal	V/N/A	V/N/A	V/N/A electronic
Shaft length	L. / XL.	L. / XL.	XL.
Transom height	508 / 635 mm	508 / 635 mm	635 mm
Instruments	Double digital - Multi functional LAN	Double digital - Multi functional LAN	Double digital - Multi functional LAN
Version	Code		
	058490 E.ST.L.PT.	058493 E.ST.L.PT.	058510 E.ST.XL.PT.
	058492 E.ST.XL.PT.	058494 E.ST.XL.PT.	
	Twins counter rotating	Twins counter rotating	
	2x Code 058495 E.ST.L.PT.	2x Code 058497 E.ST.L.PT.	



ENGINE MODEL	DESCRIPTION	CODE	QTY	ENGINE MODEL	DESCRIPTION	CODE	QTY
Guppy 2,5	THERMOSTAT	ZS100110043	1	Dorado EFI 40XS/ 40XSR/50/ 50XSR/60/60XSR	THERMOSTAT	6G81241103	1
	ANODE	ZS100079329	1		ANODE	62Y1132500	1
	PLUG, SPARK (NGK CR6HSA)	ZS100080701	1		ANODE	6G81132500	4
	IMPELLER	ZS100080068	1		ANODE	65W4525100	3
Ray 8	THERMOSTAT	66M1241101	1		TAB-TRIM	67C4537100	1
	V-BELT	60RG624100	1		ANODE	67C4525100	1
	STRAINER 1	68T2425101	1		ELEMENT, FILTER	6D82456300	1
	PLUG, SPARK (NGK BR6HS-10)	9470200274	2		V-BELT	6C54624100	1
	ANODE	6G81132500	1		OIL CLEANER	5GH1344061	1
	ANODE	68T4525100	1		PLUG, SPARK (NGK DPR6EB)	9470200418	4
	IMPELLER	68T4435200	1		IMPELLER	6H34435200	1
	WATER PUMP REPAIR KIT	68TW007801	1		WATER PUMP REPAIR KIT	63DW007801	1
Pike 9,9	THERMOSTAT	66M1241101	1	Murena EFI 40XSR/70	THERMOSTAT	6G81241103	1
	V-BELT	68T4624100	1		ANODE	62Y1132500	1
	STRAINER 1	68T2425101	1		ANODE	6G81132500	3
	PLUG, SPARK (NGK BR6HS-10)	9470200274	2		ANODE	65W4525100	3
	ANODE	6G81132500	1		TAB-TRIM	67F4537100	1
	ANODE	68T4525100	1		ELEMENT, FILTER	6D82456300	1
	IMPELLER	68T4435200	1		V-BELT	6C54624100	1
WATER PUMP REPAIR KIT	68TW007801	1	OIL CLEANER		5GH1344061	1	
Wahoo 15/20	THERMOSTAT	6AH1241100	1		PLUG, SPARK (NGK LKR7E)	9470200429	4
	ANODE	6G81132500	4		IMPELLER	6H34435200	1
	ANODE	6E51132500	1		WATER PUMP REPAIR KIT	6CJW007800	1
	ANODE	65W4525100	1		Spearfish EFI 100/100XSR	THERMOSTAT	6FP1241100
	ANODE	6AH4525100	1	ANODE		6G81132500	4
	TAB-TRIM	6AH45371004D	1	ANODE		63P1132501	1
	IMPELLER	63V4435201	1	ANODE		63P1132521	1
	OIL CLEANER	5GH1344061	1	ANODE		6H14525103	1
	ELEMENT, FILTER	61N2456310	1	TAB-TRIM		6E54537101	1
	V BELT	6AH4624100	1	OIL CLEANER		5GH1344071	1
PLUG, SPARK (NGK DPR6EB)	9470200418	2	SPARK PLUG (NGK LKR6E 9N)	9470200440		4	
WATER PUMP REPAIR KIT	6AHW007801	1	V-BELT	6FPW462400		1	
Amberjack 25	THERMOSTAT	6FM1241100	1	ELEMENT, FILTER		6D82456300	1
	ANODE	6G81132500	4	IMPELLER		6E54435201	1
	ANODE	65W4525100	1	WATER PUMP REPAIR KIT		68VW007801	1
	TAB-TRIM	6644537101	1	Swordfish EFI 115/115XSR	THERMOSTAT	6EK1241100	1
	OIL CLEANER	5GH1344061	1		ANODE	6G81132500	3
	ELEMENT, FILTER	6D82456300	1		ANODE	63P1132501	1
	V-BELT	6FM4624100	1		ANODE	67F1132501	1
	PLUG, SPARK (NGK DPR6EB)	9470200418	2		ANODE	6EK1132500	1
	IMPELLER	6L24435200	1		ANODE	6H14525103	1
	WATER PUMP REPAIR KIT	6FMW007801	1		TAB-TRIM	6E54537101	1
Aruana EFI 40	THERMOSTAT	6G81241103	1		OIL CLEANER	5GH1344071	1
	OIL CLEANER	5GH1344061	1		SPARK PLUG (NGK LKR6E)	9470200437	4
	ANODE	6G81132500	4		V-BELT	6EKW462400	1
	ANODE (VERSION S)	6634525100	1		ELEMENT, FILTER	6D82456300	1
	ANODE	65W4525100	1		IMPELLER	6E54435201	1
	TAB-TRIM	67C4537100	1	WATER PUMP REPAIR KIT	68VW007800	1	
	ANODE	67C4525100	1	Naxos 9,9/15	THERMOSTAT	7515010	1
	ANODE	62Y1132500	1		SPARK PLUG (NGK B6H)	8570010	2
	PLUG, SPARK (NGK DPR6EB)	9470200418	3		IMPELLER	8095020	1
	V-BELT	6C54624100	1		ANODE	2504035	1
	ELEMENT, FILTER	6D82456300	1		ANODIC TRIM ZAMA	2500010	1
	IMPELLER	6H44435202	1		Antibes 25/30	THERMOSTAT	7515010
WATER PUMP REPAIR KIT	6BGW007800	1	SPARK PLUG (NGK B6H)			8570010	2
			WATER IMPELLER			8095050	1
			ANODE			2504020	1
			FUEL FILTER			7510510	1
			ANODIC TRIM			2500065	1



050500

050501



050502



050503



050510



050511



050520



050521



050530



050531



050532



050533



050560



050535



050540



050536



050537



050538



050585

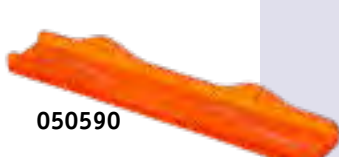

050590



050595

**allpa® Super Boat Trailer Rollers and Bow Stops**

**NON-MARKING!**

Our rollers do not leave the black scuff marks that black rubber rollers do. No more hard work cleaning the bottom of your boat.

- Guaranteed to outlast any other rollers on the market
- Will not mark your boat
- Won't flat spot
- Extremely cut resistant

**LONG LASTING**

allpa Super Trailer Rollers are made of polyurethane, to replace rubber and PVC rollers that need frequent replacement. Although they cost more initially, their long life makes them economical in the long run. Polyurethane is extremely cut and abrasion resistant. Won't split or crack, even in extreme cold.

**„V“ Bow Stops**

Item Code 050500	3" (75mm) / Hole 1/2" (13mm)
Item Code 050501	4" (100mm) / Hole 1/2" (13mm)

**V Rollers**

Item Code 050502	3" (75mm) / Hole 1/2" (13mm)
Item Code 050503	4" (100mm) / Hole 1/2" (13mm)

**Bow Roller Sets**

Ultimate Bow Stop, complete set with non-marking "Super Roller" bow stopper-roller, including mounting hardware:

Item Code 050510	3" (75mm) / Hole 1/2" (13mm)
Item Code 050511	4" (100mm) / Hole 1/2" (13mm)

**Keel Rollers**

Item Code 050520	4" (100mm) / Hole 5/8" (16mm)
Item Code 050521	5" (127mm) / Hole 5/8" (16mm)

**Keel roller, tapered, with sealed steel bushing**

Item Code	Length	Outer	Hole
050530	8" (200mm)	3-1/4" (82mm)	5/8" (16mm)
050531	10" (250mm)	3-1/4" (82mm)	5/8" (16mm)
050532	12" (300mm)	3-1/4" (82mm)	5/8" (16mm)
050533	18" (460mm)	3-1/4" (82mm)	5/8" (16mm)

**Self-centering Keel Roller - New!**

Item Code 050560	12" (300mm)
	2-3/4" (70mm)
	5/8" (16mm)

**Flat roller**

Item Code 050535	12" (300mm)
	Outer 2-1/2" (63mm)
	Hole 5/8" (16mm)

**Wobble roller, extra soft**

Item Code 050540	ø 3-1/2" (89mm)
	Outer (89mm)
	Hole (20mm)
	Internal depth both sides 32 mm

**End caps**

Item Code 050536	3" (76mm) / Hole 1/2" (13mm)
	for bow roller Item Code 050502

Item Code 050537	3-1/4" (82mm) / Hole 5/8" (16mm)
	for keel rollers

Item Code 050538	Ø2-1/2" (63,5mm) / Hole 5/8" (16mm)
------------------	-------------------------------------

**Pads**

Item Code 050585	1-1/2" x 12" (38 x 205mm)
------------------	---------------------------

Item Code 050590	2" x 12" (51 x 305mm)
------------------	-----------------------

Item Code 050595	3" x 12" (76 x 305mm)
------------------	-----------------------

### Zinc plated trailer winches with handle.

One speed.

**Item Code 078001** 3.1:1 Pull 360kg

**Item Code 078002** 4.1:1 Pull 635kg

Zinc plated trailer winch with removable handle. Two speed:

**Item Code 078003** 4:1 en 8:1 Pull 820kg

### Zinc Plated Trailer Winches 1 & 2 Speed



### Electric trailer winches with remote control.

Universal mounting. Can be operated manually as well.

1. **Item Code 449100** 12V. Max.40A/0.30kW. Incl. remote control. Pulling capacity: 2722 kg (trailer), 2268kg (water), 907 kg (sand) Steel wire 5.1mm x 9m, Dims. 240 x 254 x 190mm. Weight incl. mounting plate: 9.8kg. Rotates one side.

2. **Item Code 449105** 12V. Max.50A/0.48kW. Incl. remote control. Pulling capacity: 4082 kg (trailer), 3175 kg (water), 3161 kg (sand) Steel wire 5.6mm x 9m, Dims. 260 x 305 x 193mm.

Weight incl. mounting plate: 13kg. Rotates two sides.

### Electric Trailer Winch 0,30 kW/0,48kW



**Item Code 078010** 4500 x 50mm

**Item Code 078011** 6000 x 50mm

**Item Code 078012** 7500 x 50mm

### Trailer Winch Webbing with Hook

**Item Code 078050** 6000 x 50mm.

Breaking load 3000kg, safe working load 1500kg

### Webbing with hook and Tie Down Ratchet

**Item Code C3125250** 25 x 2500mm

### Adjustable belt with buckle

**Item Code 069158** Cast aluminum head with high-strength aluminum shaft. Supports the cantilevered weight of the motor. Stabilizes engine and steering mechanism when trailering. Varying adjustability. Includes 15"/ 38cm black EPDM rubber holding strap.

### Motor Support Kit

**NEW**



### Extra heavy keel rollers with nylon bushing

**Item Code 078030** L = 190mm. Hole = 16mm 1

**Item Code 078031** L = 305mm. Hole = 16mm 1

**Item Code 078032** L = 432mm. Hole = 16mm 1

**Item Code 078021** Keel Roller L = 102mm. Hole = 10mm 2

**Item Code 078022** Keel Roller L = 127mm. Hole = 16mm 2

**Item Code 078020** Bow Roller 76 x 76mm with nylon bushing Hole = 12mm 3

**Item Code 078035** Wobble Roller 108 x 102mm Hole = 19mm, extra soft. 4

**Item Code 078040** Flat Roller 286 x 64mm, Hole = 16mm 5

**Item Code 078045** End Cap, Outer Ø64mm 6

### Rubber Trailer Rollers





### Water Ski Rope

**Item Code X0025650** Wood Handle with soft plastic cover  
Braided Polythene with a float



### Water Ski Rope

**Item Code X0000600** one Aluminium Handle  
with soft sure grip cover

**Item Code X0000650** Two Aluminium Handles  
with soft sure grip cover

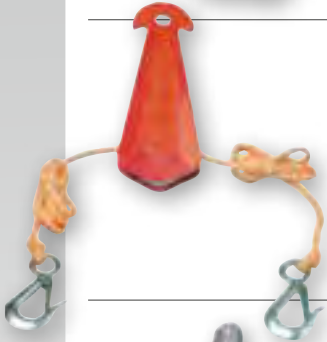

### Water Ski Triangle

**Item Code X0000500** Complete with two automatic  
diecast chromed bronze Snap Links



### Waterski Eye Tow Hook Stainless Steel 316

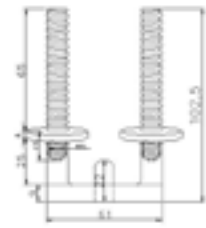
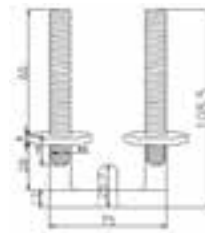

**Item Code 078395** Material Ø10mm, thread M10  
**Item Code 078396** Material Ø12mm, thread M10



### Universal Ski Mirror

**Item Code X0000265** Made of chromed ABS  
Adjustable Provides 180° Rear Vision  
C/w S.S. screws. Size 200x95mm



### Wooden Paddle

**Item Code R2600140**  
Varnished beech with wooden handle. L = 145cm.  
Shaft Ø 32x24mm. Grip Ø 52x24mm.



### Deck Wash Kit

**Item Code R3804230**  
4 Piece set composed of Boat Hook, Cotton Brush,  
Scrubbing Brush and Telescopic Handle. L = 1200-2100mm.



### Mooring Hook

**Item Code R3804150**  
Fits the Handle of the Deck Wash Kit.

**Item Code R0330180** L=1800mm

**Item Code R0330210** L=2100mm

Varnished Wood.

**Wooden Boat Hook with Chromed Brass Hook**



**Item Code 026000**

L = 1200-2100mm. Silver anodised aluminum pipe and nylon hook. **ø35mm**

**Telescopic Boat Hook Aluminum Extra Strong**



**Item Code R0030120**

L = 1300-2100mm. Long silver anodised aluminum pipe **ø30mm** and nylon hook.

**Telescopic Boat Hook**



**Item Code R0030060**

L = 600-1100mm. Short silver anodised aluminum pipe and nylon hook.

**Telescopic Boat Hook MINI**



**Item Code 026001**

L = 1100-2000mm. Silver anodised aluminum pipe with built-in Bilge Pump. Capacity: 15l/min. **ø35mm**

**Telescopic Boat Hook-Pump**



**Item Code R0025165**

L = 1650mm. Aluminum pipe, nylon hook. **ø25mm**

**Fixed Boat Hook**



**Item Code R0035165**

L = 1650mm. Aluminum pipe, nylon hook. **ø35mm**

**Fixed Boat Hook**



**Item Code R2025030**

Length 550-900mm  
Telescopic steering oar  
Made of aluminum pipe of **ø30mm** with plastic blade.

**Auxiliary Steering Oar**



**Item code 269040**

Made of anodised aluminum telescopic pipe with plastic blade and hook.  
Length 850 - 1650mm. Tube size **ø27mm**.

**Auxiliary Steering Oar**

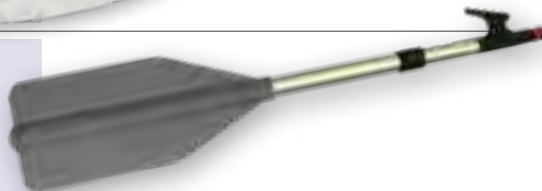

**Item Code 026200**

Made of anodised aluminum telescopic pipe with plastic blade and hook.  
Length 1650 - 2000mm. Tube size **ø30mm**.

**Auxiliary Steering Oar**



**Item Code 026165** Made of anodised aluminum pipe with plastic blade  
Length 1650 mm. Tube size **ø35mm**.

**Auxiliary Steering Oar**



# ALL-CLEAN CLEANING PRODUCTS



allpa  
**"BIG BRUSH"**  
Wash brush

**Item Code 061920** allpa "BIG BRUSH" Wash brush

The allpa-wash brush comes with a telescopic handle (115-185cm). Tube material thickness 0,8mm. The soft brush with rubber bumper is very suitable for washing of your boat. Thanks to the quick connect coupling this brush can easily be connected to a Gardena fitting.



allpa  
**Hand wash brush**

**Item Code 061940** allpa Hand wash brush

The allpa hand wash brush removes in an instant coarse and fine dirt of gelcoated or painted surfaces. The rubber handle has a perfect grip and the brush is made of splitted polyester fibres with which hard-to-reach spots can be thoroughly cleaned.



allpa  
**Dreadlock  
Sponge  
Washing Mitt**

**Item Code 061925** allpa Dreadlock Sponge Washing Mitt

Micro fibre non-abrasive washing mitt with Dreadlocks is ideal for quickly removing dirt from surfaces and will not leave any scratches. This washing mitt is perfect for thorough cleaning of gelcoated and painted surfaces, windows, floors and hard-to-reach spots.



allpa non-  
**abrasive Micro  
fibre and Insect  
Sponge**

**Item Code 061930** allpa non-abrasive Micro fibre and Insect Sponge Micro fibre sponge mitt with special non-abrasive side for scrubbing of stubborn dirt. These micro fibres have large absorbent capacity. The dry mitt is also very suitable to remove dust or polishing waxed surfaces.



allpa sponge

**Item Code 061935** allpa sponge

Light weighted strong washing sponge with a special non-abrasive scrubbing side. This sponge has a large absorbent capacity for a thorough cleaning of the boat.



# allpa Nautical Bucket "the Original"

**Item Code P002** PVC bucket 7,5L.  
With PVC handle

allpa  
Nautical Bucket  
"the Original"



**Item Code P001** Rubber bucket 7,5L. Extra heavy with  
galvanized handle and thimble.

Nautical  
Bucket



## allpa BOAT CLEANER

Concentrated product for cleaning of fiberglass or metal boats.

**Item Code 061900** Bottle 1 l

## allpa INFLATABLE BOATCLEANER

Concentrated product for cleaning of Hypalon and PVC inflatables.

**Item Code 061905** Bottle 1 l

## allpa MOTOR/BILGE CLEANER

Concentrated product for cleaning of engines and surfaces of stainless steel, chrome and plastic.

**Item Code 061910** Bottle 1 l

## allpa Boat CUSHION/BIMINI TOP CLEANER

Concentrated product for cleaning of vinyl, colorfast fabric, cushions and carpets.

**Item Code 061915** Bottle 1 l

All **allpa Cleaners** may be diluted with water in any proportion. Do not use undiluted!

Cleaning of painted surfaces requires treatment of several small parts. Not suitable for aluminum.

Dissolvability 1:100 - 1:5

**allpa Cleaners** effortlessly removes stains of animal, plant and mineral products, grease, oil, rust and other pollution.

**allpa Cleaners** could cause irritation of skin and/or mucous membranes when overdosed.

allpa  
Boat Cleaners

Very Strong  
Concentrated  
Special Cleaning  
Liquid



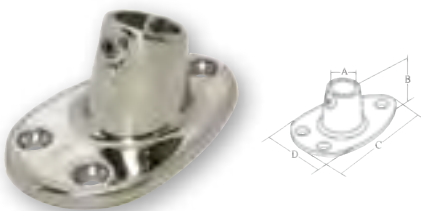

**Stainless Steel Flag Pole Base**

**Item Code 078755**

A = 19mm, B = 30mm,  
C = 84mm, D = 51mm



**Stainless Steel Flag Pole Base**

**Item Code 078760**

A = 25mm, B = 51mm, C = 65mm



**Flag Pole Base 45°**

**Item Code N2100110** Stainless Steel. 45° ID = 22mm. Base 44 x 78mm.

**Item Code N2100120** Stainless Steel. 45° ID = 22mm. Base Ø65mm



**Stainless Steel Flag Pole Base**

Heavy-Duty Flag Pole Base  
Stainless Steel 316 with securing,  
Ø25mm, L=450mm

**Item Code 913820** 90°, base Ø70mm

**Item Code 913821** 45°, base Ø70mm



**Stainless Steel Flag Pole Base**

Heavy-Duty Flag Pole Base  
Stainless Steel 316 with securing,  
Ø25mm, L=450mm

**Item Code 913825** 90°, base 81x42mm

**Item Code 913826** 45°, base 81x42mm



**Stainless Steel recessed Flag Pole Base**

Recessed Flag Pole Base out of Stainless Steel 316, suitable for Ø25mm Flag Poles.

**Item Code 269020** 45°, built-in depth: 5cm

Among other things suitable for flagpole  
Item Code 913817 (C) see page 193



**Flag Pole Bases**

**Item Code N2160000** Chromed brass 45°, Ø 22mm

**Item Code N2100140** Chromed brass 90°, Ø 22mm



**Stainless Steel Adjustable Base for Light Pole**

**Item Code 072645**

Ø19mm



**Stainless Steel Flag Pole Support**

**Item Code N2122020** With adjustable bracket for mounting on railing, stanchion or bulkhead 45°, Ø22mm

**Item Code 078750**

Removable Conical Pole and watertight Base with Closing Cap  
 A = 610mm, B = 19mm, C = 302mm, D = 250mm  
 Base dimensions: 75 x 45 x 70mm (lxwxh)



**Stainless Steel Flag Pole with Base**

*stainless steel*  
**316**

With Deck Mount Base

**Item Code 913807** L = 460mm, 30°Base

**Item Code 913810** L = 460mm, 90°Base

**Stainless Steel Conical Flag Pole**



Sturdy Flagpole Stainless Steel 316

**Item Code 913813** L=600, Ø25mm suitable for 30x45 Flag (A)

**Item Code 913811** L=1000, Ø25mm (B)

Flagpole with lock

**Item Code 913817** L=600mm for flagpole holder art. 269020 (C)

**Item Code 913816** L=1000mm for flagpole holder art. 269020 (C)

**Stainless Steel Flagpole**

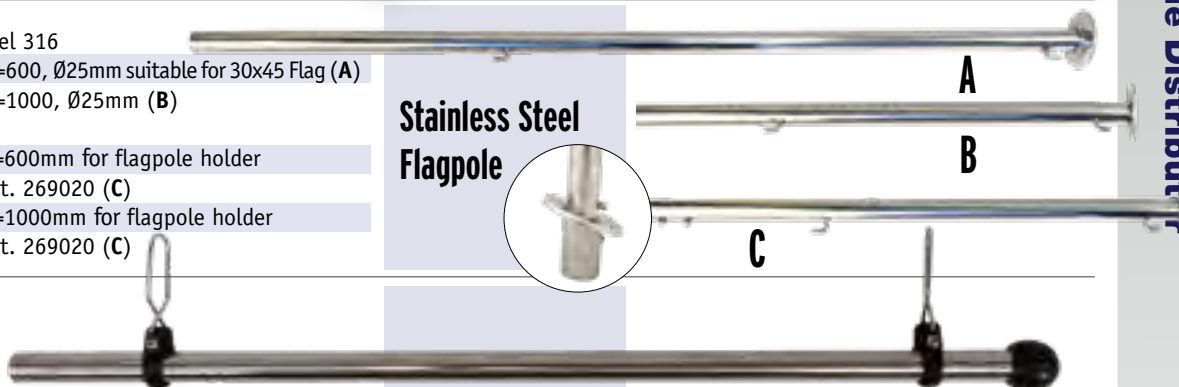

**Item Code 078745** With clips for easy mounting  
 A = 425 mm, B = 13mm

**Stainless Steel Pennant Bar**

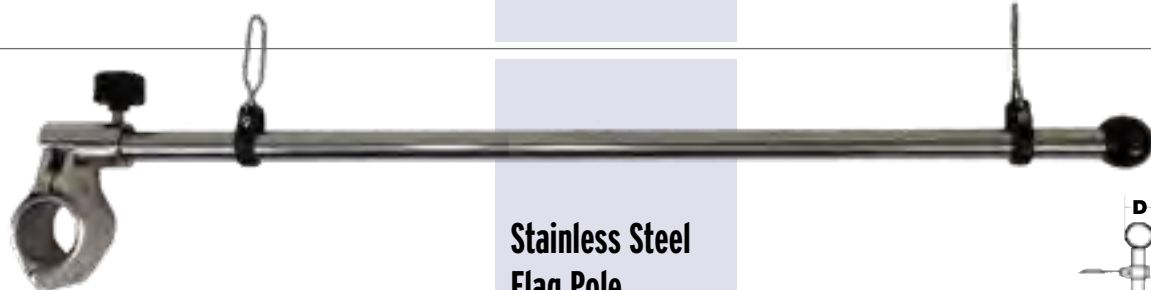

**Stainless Steel Flag Pole**

**Item Code 078390** Stainless Steel Flag Pole Railing Mount  
 A=450mm, B= 90mm,  
 C= 25mm, D= 12mm

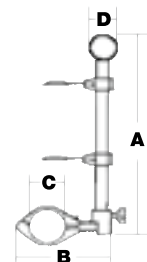

Varnished wood, Ø28 mm, base end Ø22 mm, with nylon cleat

**Item Code N2122060** L= 600mm

**Item Code N2122080** L= 800mm

**Wooden Flag Poles Renew**

Varnished wood, Ø28 mm, base end Ø22 mm, with nylon cleat

**Item Code N2128100** L=1000mm

**Item Code N2128125** L=1250mm



for Rubber Boats complete with Base

**Item Code N2140031** L = 400mm, bow mount

**Item Code N2140027** L = 400mm, transom mount

**Nylon Flag Pole**





Dutch Province Flags 20x30cm:	
Drenthe	Item Code DR2030
Flevoland	Item Code FL2030
Friesland	Item Code FR2030
Noord-Brabant	Item Code NB2030
Noord-Holland	Item Code NH2030
Overijssel	Item Code OV2030
Gelderland	Item Code GE2030
Groningen	Item Code GR2030
Limburg	Item Code LI2030
Zuid-Holland	Item Code ZH2030
Utrecht	Item Code UT2030
Zeeland	Item Code ZE2030
Geuzen Flag	Item Code GEU2030
Geuzen Flag	Item Code GEU3045

Swiss Canton Flags 20x30cm:	
Aargau	Item Code AA2030
Appenzell	Item Code AP2030
Basel Land	Item Code BL2030
Basel Stadt	Item Code BS2030
Bern	Item Code BE2030
Freiburg	Item Code FB2030
Genf	Item Code GEN2030
Glarus	Item Code GL2030
Graubunden	Item Code GB2030
Jura	Item Code JU2030
Luzern	Item Code LU2030
Neuemburg	Item Code NEU2030
Nidwalden	Item Code NI2030
Obwalden	Item Code OB2030
Schaffhausen	Item Code SHH2030
Schwyz	Item Code SZ2030
Solothurn	Item Code S02030
St. Gallen	Item Code ST2030
Tessin	Item Code TE2030
Thurgau	Item Code TH2030
Uri	Item Code URI2030
Waadt	Item Code WA2030
Wallis	Item Code WAL2030
Zürich	Item Code ZU2030
Zug	Item Code ZUG2030



German State Flags 20x30cm:	
Niedersachsen	Item Code NIE2030
Hesse	Item Code HE2030
Hamburg	Item Code HA2030
Bremen	Item Code BR2030
North Rhine-Westphalia	Item Code NRW2030
Rhineland-Palatinate	Item Code RP2030
Saxony	Item Code FS2030
Mecklenburg-Vorpommern	Item Code MV2030
Brandenburg	Item Code BB2030
Baden-Württemberg	Item Code BW2030
Saxony-Anhalt	Item Code SA2030
Saarland	Item Code SAA2030
Thuringia	Item Code TU2030
Schleswig-Holstein	Item Code SH2030
Bayern	Item Code BA2030
Berlin	Item Code BER2030

Austria State Flags 20x30cm:	
Burgland	Item Code BU2030
Oberösterreich	Item Code OO2030
Kärnten	Item Code KA2030
Niederösterreich	Item Code NO2030
Tirol	Item Code TIR2030
Steiermark	Item Code STM2030
Wien	Item Code WIE2030

Fun Flags 50x75cm:	
Pirate Flag	Item Code PIRAT5075
Wine Flag	Item Code WIJN5075
Beer Flag	Item Code BIER5075

National Flags with EU-insert 40x60cm:	
Europe - NL	Item Code EGNL4060
Europe - DE	Item Code EGBRD4060
Europe - BE	Item Code EGBLG4060

Yellow "Q" Flag:	
30x45cm	Item Code Q3045

Red Regatta Flag:	
30x45cm	Item Code B3045

International Signal Flag Set:	
20x30cm	Item Code 029145





Dutch Flags:	
20 x 30cm	Item Code NL2030
30 x 45cm	Item Code NL3045
40 x 60cm	Item Code NL4060
50 x 75cm	Item Code NL5075
70 x 100cm	Item Code NL70100

German Flags:	
20 x 30cm	Item Code BRD2030
30 x 45cm	Item Code BRD3045
40 x 60cm	Item Code BRD4060
50 x 75cm	Item Code BRD5075
70 x 100cm	Item Code BRD70100

Belgian Flags:	
20 x 30cm	Item Code BLG2030
30 x 45cm	Item Code BLG3045
40 x 60cm	Item Code BLG4060
50 x 75cm	Item Code BLG5075
70 x 100cm	Item Code BLG70100
100 x 150cm	Item Code BLG100150
150 x 225cm	Item Code BLG150225

Swiss Flags:	
20 x 30cm	Item Code CH2030
30 x 45cm	Item Code CH3045
40 x 60cm	Item Code CH4060
50 x 75cm	Item Code CH5075
70 x 100cm	Item Code CH70100

Austria Flags:	
20 x 30cm	Item Code AT2030
30 x 45cm	Item Code AT3045
40 x 60cm	Item Code AT4060
50 x 75cm	Item Code AT5075
70 x 100cm	Item Code AT70100

Guest Flags:	
Sweden 20 x 30cm	Item Code SE2030
Sweden 30 x 45cm	Item Code SE3045
Denmark 20 x 30cm	Item Code DK2030
Denmark 30 x 45cm	Item Code DK3045
Spain 20 x 30cm	Item Code ES2030
Spain 30 x 45cm	Item Code ES3045
Luxembourg 20 x 30cm	Item Code LUX2030

Dutch Flags:	
80 x 120cm	Item Code NL80120
100 x 150cm	Item Code NL100150
150 x 225cm	Item Code NL150225
200 x 300cm	Item Code NL200300
225 x 350cm	Item Code NL225350

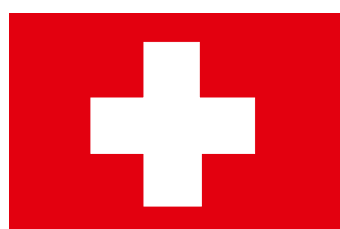

Guest Flags:	
France 20 x 30cm	Item Code FRA2030
France 30 x 45cm	Item Code FRA3045
Italy 20 x 30cm	Item Code IT2030
Italy 30 x 45cm	Item Code IT3045
Croatia 20 x 30cm	Item Code HR2030
Croatia 30 x 45cm	Item Code HR3045





### Bosun's Chair "ECO"

Bosun's Chair Model „ECO“  
Made of PVC coated cloth, dark blue color.  
Provided with tool pockets.

Dimensions 40 x 30 cm  
Weight 0,89kg  
Breaking load 1500kg

**Item Code 015175**



### Bosun's Chair "COMFORT NEW"

Bosun's Chair Model „COMFORT NEW“  
Made of PVC coated cloth with wrap-around back,  
anthracite color. Provided with two tool pockets and a storage  
pocket.

Dimensions 45 x 45 cm  
Weight 0,90kg  
Breaking load 1500kg

**Item Code 015186**



**NEW**

### Wide Opening Watertight Containers

**Item Code 486587** Opening Ø136mm,  
173x198mm (hxØ), 3.6l

**Item Code 486588** Opening Ø136mm,  
265x198mm (hxØ), 6l

**Item Code 486589** Opening Ø204mm,  
239x274mm (hxØ), 10l

**Item Code 486580** Ø250, H=200mm, 6l



**6l**

**Item Code 486582** Ø250, H=260mm, 8l



**8l**

**Item Code 486584** Ø250, H=380mm, 12l



**12l**

**Item Code 486586** Ø250, H=440mm, 15l



**15l**

**Watertight Containers**

**Item Code P001** Rubber bucket 7,5l. Extra heavy with galvanized handle and thimble.



**Nautical Bucket**

**Hand Suction Pumps with hose 800 mm**  
**Item Code P0250035** L = 350mm  
**Item Code P0250055** L = 550mm  
**Item Code P0250075** L = 750mm



**Hand Suction Pumps**

**Item Code P0000120** Bailer made of strong thermoplastic material



**Bailer**





**Item Code 015275**

White Plastic Pocket with Black Elastic Net.  
Size 270x115x32mm (lxwkd).  
Fixing with screws or adhesive tape.

**Plastic Pocket  
with Elastic Net**



**Item Code 015280**

Plastic Pocket.  
Size 370x185x100mm (lxwkd).  
Fixing with screws.

**Plastic Pocket**



**Item Code 015285**

Plastic Pocket with Elastic Net.  
Size 370x185x100mm (lxwkd).  
Fixing with screws.

**Plastic Pocket  
with Elastic Net**



**Item Code 015290**

Rectangular Elastic Net with Plastic Frame.  
Size 126x98mm (hwx).  
For small items like cellular phone.  
Fixing with screws or adhesive tape.

**Elastic  
Storage  
Net**



**Item Code 015295**

Rectangular Elastic Net with Plastic Frame.  
Size 180x365mm (hwx).  
For small items.  
Fixing with screws or adhesive tape.

**Elastic  
Storage  
Net**



**Item Code 015305**

„Welcome on Board“ Rug.  
Made of PVC. Blue color.  
Size 600x350mm (wxd)

**Rug**





**Drain Plug**

**Item Code 078710**

Stainless Steel Housing with Nylon Plug  
A = 39mm, B = 25mm, C = 12mm



**All Stainless Steel Drain Plug**

**Item Code 078705**

A = 54mm, B = 24mm, C = 12mm



**Adjustable Brass Snap Drain Plug**

**Item Code 269050** Adjustable Brass Snap Drain Plug - Ø 1" (25,4mm)

**Item Code 269051** Adjustable Brass Snap Drain Plug - Ø 1-1/4" (31,75mm)



**Nylon Drain Socket**

**Item Code 001420** Black Nylon

Dim	A	C	D	E
mm.	24,7	27	42,3	23,6

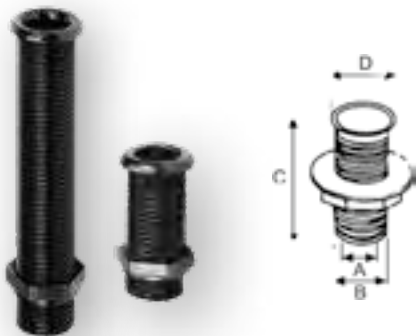

**Sleeves for expanding drain plug**

**Item Code 001421** Black Nylon, L = 62mm

**Item Code 001422** Black Nylon, C=155mm

A=22,67mm, B=30mm, D=39mm, diam. 22mm



**Expanding Drain Plug**

**Item Code 008566** Drain plug ø22mm

Fits drain plug sleeve code 001421/22

**Item Code 1645312** Drain plug ø40mm



**Adjustable expanding Drain Plug**

**Item Code 008569** Expanding drain plug ø 22mm

**Item Code 1643253**

Nylon skin fitting with anti-reflux flap.  
Thread diameter 55mm. Hose 50mm.  
Flange 75mm. Length 60mm.

**Skin fitting with anti-reflux flap**



**Item Code 1647088**

Nylon skin fitting with flap klep.  
Mounting 79mm. Hose 50mm.  
Max. flap diameter 130mm.

**Skin fitting with flap**



Pressable skin fitting

**Item Code 1610258** Thread diameter 1¼" Length 28 - 44mm  
Flange Size 57mm, Inner Size 30mm.

**Pressable skin fitting**

**Item Code 1610259** Thread diameter 1¼" Length 48 - 75mm  
Flange Size 54mm, Inner Size 30mm.



**Item Code 1670598**

Chrome skin fitting with plastic screw nut.  
Thread diameter 1".  
Hose 25mm.

**Chrome skin fitting**



**Item Code 008569** Matching Extending Drain Plug.

**Item Code 1645393** Anti-reflux flap for **160598**



**Item Code 1690373** PVC Ball Valve ½"

**Item Code 1690374** PVC Ball Valve ¾"

**Item Code 1690375** PVC Ball Valve 1"

**Item Code 1670979** PVC Ball Valve 1 ¼"

**Item Code 1670980** PVC Ball Valve 1 ½"

**Ball Valves**





Pump Hose

Pump hose siphoning liquid without electricity and sucking. Suitable for Petrol, Diesel and Water.

Item Code 1670002 Ø12.5 mm L=1600mm

Item Code 1670003 Ø25.0 mm L=1600mm



Stainless Steel Pull Ring

Item Code 048958

55 x 65mm

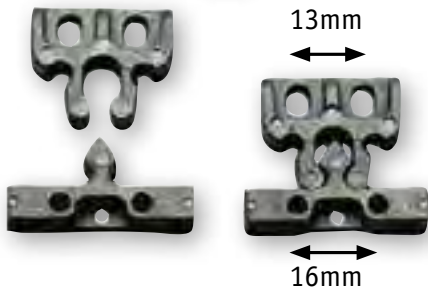

Door Fasteners Nylon

Item Code 004330/W

White

Item Code 004330/Z

Black



Rowlock Sockets

Black Nylon Ø17mm, open

Item Code N1624 Side Mounting Bracket

Item Code N1625 Universal Socket



Rowlocks

Item Code N7678

Black Nylon Ø51mm

Item Code N7679

Black Nylon Ø56mm

Hole Ø=14mm. Suitable to fix canvas covers.  
Skin pack card-board 12 pieces. Price per 12 pieces

Item Code A2214000 Blue

Item Code A2216000 White

### Plastic Grommets



Packing 50 pieces, price per piece

Code 004801 Ø4mm Code 004803 Ø8mm

Code 004802 Ø6mm Code 004804 Ø10mm

### White Nylon Snap Hooks



Item Code C2505015 Nylon, Color Rose, for 5mm cord

Item Code C2506015 Nylon, Color Lilac, for 6mm cord

Item Code C2508015 Nylon, Color Red, for 8mm cord

### "Olive" for shock cord



Black Nylon

Item Code 008440 Ø15mm

Item Code 008442 Ø20mm

Item Code 008445 Ø25mm

Item Code 008450 Ø30mm

Item Code 008451 Ø35mm

Item Code 008480 Ø40mm

Item Code 008481 Ø45mm

### Multipurpose Clips



for Inflatable Boat Cover

Item Code 004799

### Nylon Hook



Black Nylon Can be fitted to tubes due to special base

Item Code N4773

### Semi closed Hook



Black Nylon Can be fitted to tubes due to special base

Item Code N4771

### Multipurpose Hook (reefing)



Item Code 078610

Set of 2 pieces

A = 56mm, B = 16mm, C = 22-25mm

### Rubber Clip for Tubing



Black Nylon Can be fitted to tubes

Item Code N6178

Fairlead Ø10mm

Mounting hole distance 29mm

### Small Fairlead



Black Nylon

Item Code 003604 Ø6mm

Item Code 003603 Ø8mm

Item Code 003602 Ø12mm

### Deck Eyes



Made of Brass and Stainless Steel

Item Code A mm B mm C mm D mm

078890 30 22 13 5

078891 40 33 14 6

078892 50 40 16 8

### Marine Padlocks





### Black Cone

**Item Code 008004**

Black Nylon  
2-piece cone, 460 x 330mm



### Black Anchor Ball

**Item Code 008005**

2-piece, black Nylon  
Obligatory! Ø350mm



### Wind Indicators

Made of plastic and aluminum

**Item Code N2000090** large model, Ø8mm



### Wind Indicator

Made of stainless steel with red spy fabric

**Item Code 132001** Standard model 120 x 100mm



### Wind Sock

**Item Code N2006025**

Stainless Steel with nylon fabric. Dims. Ø 60 x 250mm

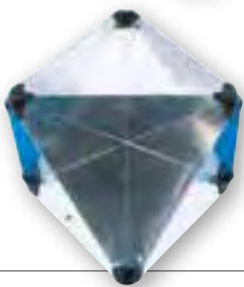

### Radar reflectors

**Item Code L3400041** Radar reflector, foldable, aluminum.  
Size 30cm (Standard). Weight 470 gr. Array: 8m<sup>2</sup>

**Item Code L3400043** Radar reflector, foldable, aluminum.  
Size 40cm (R.O.R.C.). Weight 900 gr. Array: 10m<sup>2</sup>

**Item Code L3400046** Radar reflector, foldable, aluminum.  
Size 46cm (I.O.R.). Weight 1100 gr. Array: 12m<sup>2</sup>



### Tubular Radar Reflector

L=585mm, ø50mm, Reflecting Area 2m<sup>2</sup>  
Weight 380 gram, Range: 2,5 Nautical Miles

**Item Code 072500** For Sailing Yachts  
With eyes for hoisting

**Item Code 072501** For Motor Yachts

**Item Code N6695/Z**

Black Nylon Rod Holder. Universal Mounting:  
Railing (25 mm), Deck or Side mount  
Max. 40mm Ø Rod, length 215mm

**Fishing Rod Holder**



Black Nylon Built-In Holders, with cover.

**ItemCode N6693/Z** Black, Max 40mm Ø Rod, L = 230mm

**ItemCode N6693/W** White, Max 40mm Ø Rod, L = 230mm

**Fishing Rod Holders**



**Item Code 078430**

Built in Rod Holder with Cover, Max 40mm Ø Rod, L = 240mm  
Flange 115x90mm, built-in size Ø 51mm

**Stainless Steel Fishing Rod Holder**



**Item Code 078432**

Side Mount  
Max 45mm Ø Rod, L = 260mm

**Stainless Steel Fishing Rod Holder**

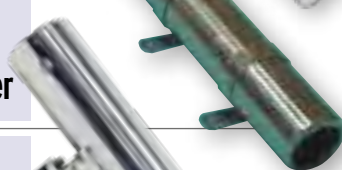

**Item Code 078431**

S/S Rod Holder for railing mounting.  
Railing Ø25-30mm. Length 215mm. Max Rod Ø 40mm.

**Stainless Steel Fishing Rod Holder**

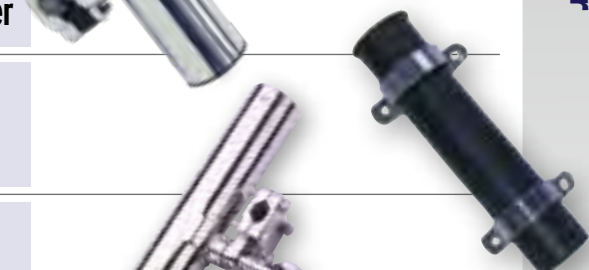

**Item Code 078433**

Black Nylon Rod Holder Side Mount  
Max. 41mm Ø Rod, length 230mm

**Fishing Rod Holder**



**Item Code M2680272**

S/S Rod Holder for railing mounting. Railing Ø 25mm.  
Length 250mm. Max Rod Ø40mm.

**Stainless Steel Fishing Rod Holder**



**Item Code 078434**

Side Mount  
Max. 38mm Ø Rods

**Fishing Rod Holder Three Rod Storage rack**



**Item Code M2654077** Plastic Fishing Rod Holder  
Deck mount

**Plastic Fishing Rod Holder**



**Item Code M2654078** Plastic Fishing Rod Holder  
Railing mount (Ø25mm)

**Plastic Fishing Rod Holder**



**Item Code M2654079** Plastic Fishing Rod Holder  
Side mount

**Plastic Fishing Rod Holder**





### Standard Sail Ties

Plastic Hook, sold as 4 per polybag

<b>Item Code C0404020</b>	Length 200mm
<b>Item Code C0404035</b>	Length 350mm
<b>Item Code C0404055</b>	Length 550mm



### Sail Lashes with Ball End

Model „EXTRA“ sold as 4 per carton

	ø mm	Length (mm)
<b>Item Code C0804030</b>	4	300
<b>Item Code C0804040</b>	4	400
<b>Item Code C0804050</b>	4	500
<b>Item Code C0804060</b>	4	600

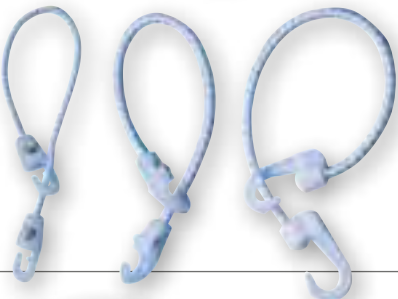

### Sail Ties

With plastic hooks  
4 per polybag

	ø mm	Length (mm)
<b>Item Code C0004020</b>	4	200
<b>Item Code C0004030</b>	4	300
<b>Item Code C0006030</b>	6	300
<b>Item Code C0008050</b>	8	500
<b>Item Code C0010100</b>	10	1000 per Unit

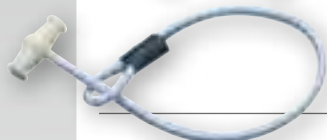

### Sail Ties with Toggles from Nylon

sold as 4 per carton

	ø mm	Length (mm)	Color
<b>Item Code C0206035</b>	6	350	white
<b>Item Code C0206055</b>	6	550	white



### Sail Ties with „Olive“

With lock-system, for an adjustable loop.  
Sold as 4 per carton.

	ø mm	Length (mm)
<b>Item Code C0705055</b>	5	550
<b>Item Code C0706075</b>	6	750
<b>Item Code C0708080</b>	8	800

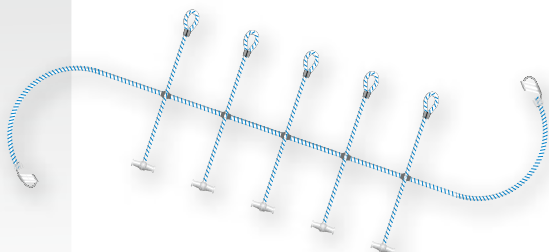

### Mainsail Centipede

Designed for lashing the mainsail to booms. Nylon belay pins with brass stops and stainless steel hooks on each end to attach to mast and boom end. Packaging unit: one in Polybag.

	ø mm	Length (mm)
<b>Item Code C0708180</b>	8	2000
<b>Item Code C0708280</b>	8	3000
<b>Item Code C0510300</b>	10	3000



### Sail Ties

Sail ties, sold as 50 per polybag

<b>Item Code C2505015</b>	Nylon, Color Pink, for 5mm cord
<b>Item Code C2506015</b>	Nylon, Color Purple, for 6mm cord
<b>Item Code C2508015</b>	Nylon, Color Red, for 8mm cord



### Shock Cord Hooks

Color black, sold as 50 per polybag

<b>Item Code C2805080</b>	ø 5-6mm
<b>Item Code C2608019</b>	ø 8mm



### Allround Hook with Clip

From very strong plastic.  
For bungee cords, to install securely in seconds.  
Sold as 50 per polybag

<b>Item Code C2506010</b>	ø 6mm
<b>Item Code C2508012</b>	ø 8mm



Meas. (mm):	∅	L	I	F	O
Item Code 340100	5	65	30	38	22
Item Code 340200	6	75	33	45	24
Item Code 340300	8	86	35	52	26
Item Code 340400	10	110	40	65	35
Item Code 340500	12	140	65	90	35

### U-Bolt from Stainless Steel (Shroud Plate)

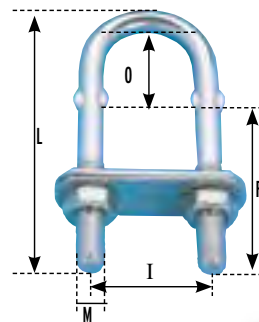

Meas. (mm):	∅ mm	∅ mm
Item Code 078530	3	Item Code 078535 10
Item Code 078531	4	Item Code 078536 12
Item Code 078532	5	Item Code 078537 14
Item Code 078533	6	Item Code 078538 16
Item Code 078534	8	

### Wire-Rope-Grip, long Stainless Steel



Meas. (mm):	∅	Width	∅hole
Item Code 210100	22	13,2	8,2
Item Code 210200	25	6,6	8,2
Item Code 210300	25	10	8,2
Item Code 210400	28,2	15	8,2
Item Code 210600	33,5	13	8,2
Item Code 210700	38,6	10	8,2
Item Code 210800	45	13,2	8,2
Item Code 210900	53	15,6	8,2
Item Code 211000	54,5	17	8,2

### Nylon sheaves



Meas. (mm): ∅	H1	H2	A	Meas. (mm): ∅	H1	H2	A		
470100	2	10	17	7	470700	8	29	45	18
470200	2.5	14	22	8	470800	10	37	58	24
470300	3	15	24	9	470900	12	47	70	29
470400	4	18	28	11	471000	14	55	82	33
470500	5	20	32	14	471600	16	65	91	36
470600	6	23	37	15					

### Stainless Steel Thimbles



M1105000 ∅ 5mm	M1116000 ∅16mm
M1106000 ∅ 6mm	M1119000 ∅19mm
M1108000 ∅ 8mm	M1120000 ∅20mm
M1110000 ∅10mm	M1124000 ∅24mm
M1112000 ∅12mm	
M1114000 ∅14mm	

### Nylon-Thimbles



**Item Code 078880**  
Fits all Denk Entries. Unbreakable  
L=98mm B=57mm

### Stainless Steel Universal Key for Deck Entries



**Item Code 078880**  
Designed to fit all deck plate caps  
L = 98mm, B = 57mm

### Universal Deck Plate key Stainless Steel



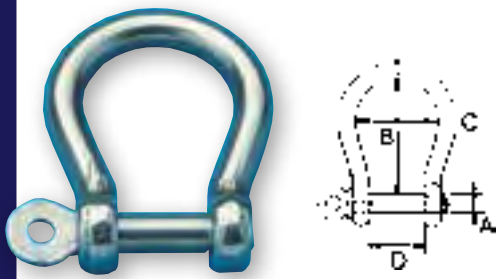

**Stainless Steel Bow Shackles**

Sizes (mm):	A	B	C	D	Breaking load
Item Code 281100	4	16	14	8	750kg
Item Code 281200	5	20	17	10	1200kg
Item Code 281300	6	24	21	12	1750kg
Item Code 281400	8	32	28	16	3000kg
Item Code 281500	10	40	34	20	5800kg
Item Code 281600	12	48	42	24	7000kg

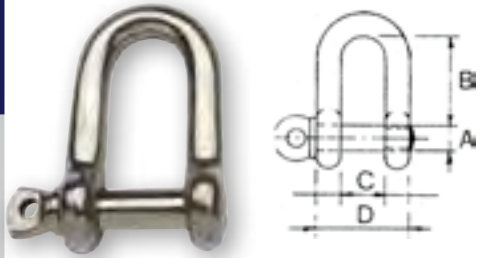

**Stainless Steel Shackles**

Sizes (mm):	A	B	C	D	Breaking load
Item Code 282100	5	20	10	20	1200kg
Item Code 282200	6	24	12	24	1750kg
Item Code 282300	8	32	16	32	3000kg
Item Code 282400	10	40	20	40	5800kg
Item Code 282500	12	48	24	48	7000kg

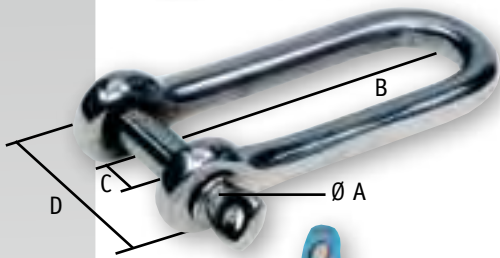

**Stainless Steel Shackles**

Sizes (mm):	A	B	C	D	
Item Code 072610	Ø6mm	Ø6	43	13	24
Item Code 072611	Ø8mm	Ø8	61	17	32
Item Code 072612	Ø10mm	Ø10	75	21	39

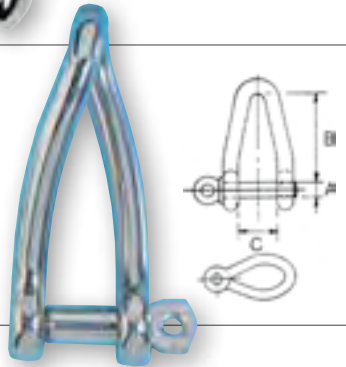

**Stainless Steel Shackles (twisted Form)**

Sizes (mm):	A	B	C	Breaking load
Item Code 283100	5	35	11	830kg
Item Code 283200	6	39	11	1180kg
Item Code 283300	8	53	17	2100kg
Item Code 283400	10	67	21	3260kg
Item Code 283500	12	83	26	4700kg

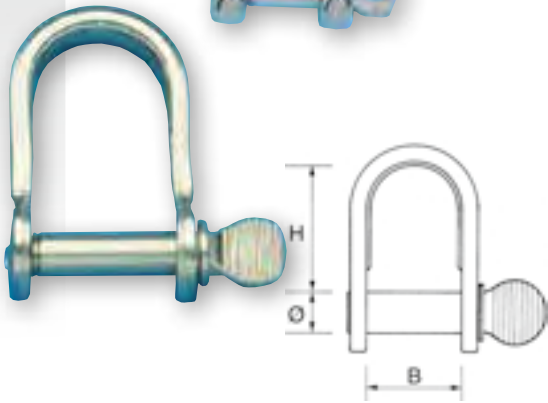

**Stainless Steel Shackles**

Sizes(mm):	Ø	B	H	Breaking load
Item Code 270100	4	10	15	550kg
Item Code 270200	4	12	24	550kg
Item Code 270300	5	12	17	1050kg
Item Code 270400	5	16	25	1050kg
Item Code 270500	5	14	40	1050kg
Item Code 270600	5	22	37	1050kg
Item Code 270700	6	16	21	2050kg
Item Code 270800	6	17	26	2050kg
Item Code 270900	6	14	28	2050kg

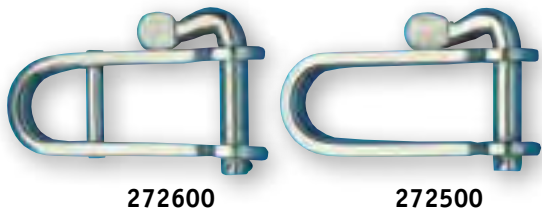

**Stainless Steel Halyard Shackles**

Sizes (mm):	Ø	B	H	Breaking load
Item Code 272500	5	14	40	1050kg
Item Code 272600	5	14	40	1050kg

272600

272500



**Stainless Steel Shackle (twisted Form)**

Sizes (mm):	Ø	B	H	Breaking load
Item Code 271100	5	12	37	1050kg

Sizes (mm):	Ø	H	Break load
290200	5	50	280kg
290300	6	60	320kg
290400	7	70	450kg
290500	8	80	800kg
290600	10	100	1200kg

**Stainless Steel Snap Hook**

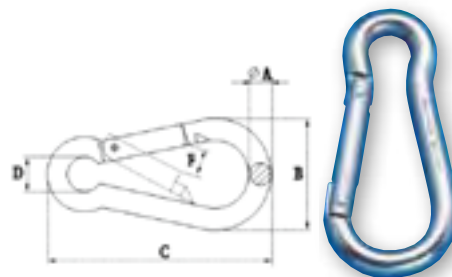

Sizes (mm):	Ø	H	Break load
291200	5	50	280kg
291300	6	60	320kg
291400	7	70	450kg
291500	8	80	800kg
291600	10	100	1200kg

**Stainless Steel Snap Hook with Eye**

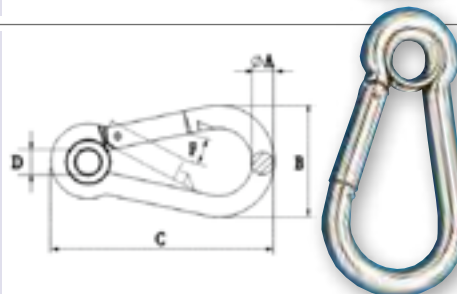

Item Code	Ø	L	Break load
292100	4mm	40mm	240kg
292200	5 mm	50mm	280kg
292300	6 mm	60mm	320kg
292400	7 mm	70mm	450kg
292500	8 mm	80mm	800kg
292600	9mm	90mm	1000kg
292700	10mm	100mm	1200kg
292800	11mm	120mm	1400kg
292900	12mm	140mm	1600kg

**Stainless Steel Snap Hook with screw opening**

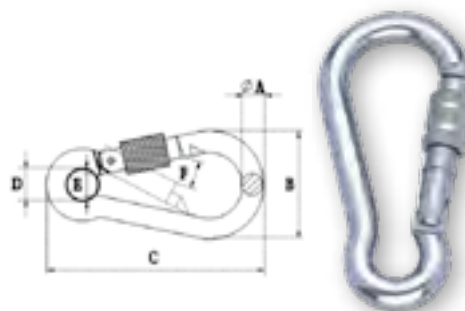

Item Code	Ø A	Ø B	Ø	L	Opening
294100	25	13	8	80	22mm
294200	31	17	10	100	24mm

**Stainless Steel Snap Hook with Assymetric Opening**

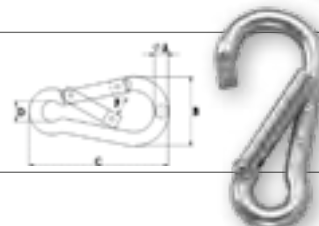

Item Code	Ø	L
294500	6mm	65mm
294600	8 mm	85mm
294700	10mm	100mm
294800	12mm	125mm

**Stainless Steel Snap Hook with Eye And Extra Large Opening**

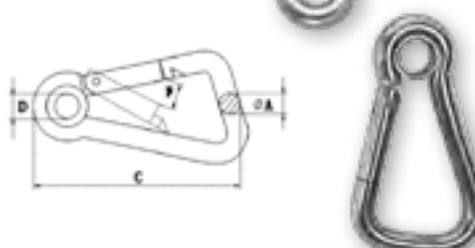

Item Code	Ø A	B	L	Break load
296100	12mm	9mm	52mm	1800kg
296200	16mm	12mm	66mm	2800kg
296300	22mm	6mm	96mm	3800kg

**Stainless Steel Snap Shackle with Fixed Eye**

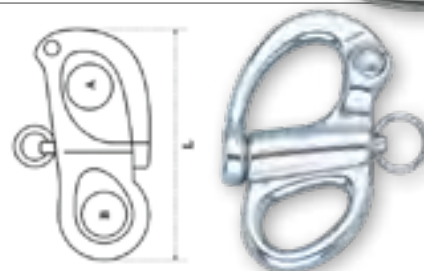

Item Code	Ø A	B
296500	16mm	83mm
296600	19mm	94mm
296700	22mm	113mm

**Stainless Steel Swivel Eye Snap**

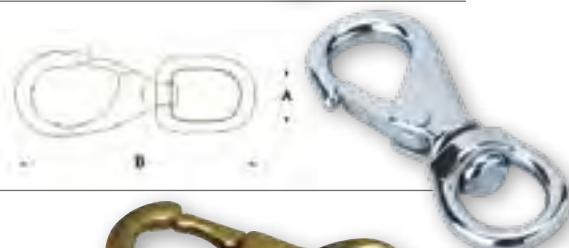

Item Code	Ø	L
297100	18mm	82mm

**Brass Eye Snap with Fixed Eye**



Item Code 072650	Snap Hooks 50mm
Item Code 072651	Snap Hooks 70mm
Item Code 072652	Snap Hooks 100mm

**Stainless Steel Snap Hooks**





**Brass Plated Eye Bolt**

Item Code 078420	M 6, stock length 60mm
Item Code 078421	M 8, stock length 100mm
Item Code 078422	M12, stock length 150mm

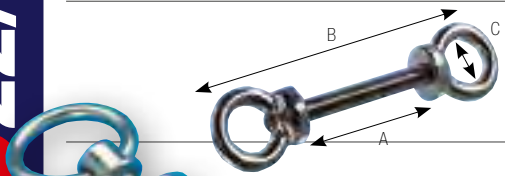

**Double Eye Bolt M8**

For hull thickness till 40mm chrome plated brass

Item Code 001111	A = 48mm
	B = 88mm
	C = 21mm

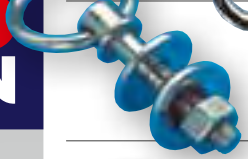

**Stainless Steel Eye Bolt with movable Ring**

Item Code 600100	M10, stock length 55mm
------------------	------------------------

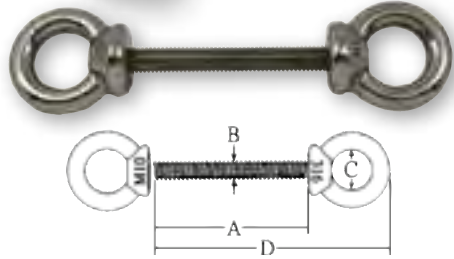

**Stainless Steel Double Eye Bolt**

Item Code	A mm	B mm	C mm	D mm
078735	80	8	17	116
078736	100	10	22	145

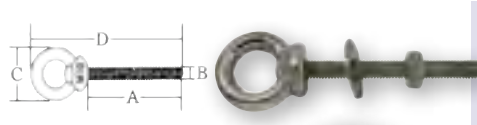

**Stainless Steel Eye Bolt**

Item Code	A mm	B mm	C mm	D mm
078730	100	8	33	136
078731	100	10	42	145
078732	120	12	56	177



**Stainless Steel Eye Nut**

Item Code	A mm	B mm	C mm	D mm
078720	33	36	8	8
078721	42	45	10	10
078722	56	57	12	12

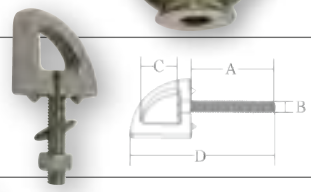

**Stainless Steel Screw Eye**

Item Code 078725  
Ideally for fastening your Dinghy!  
A = 102mm, B = 12mm, C = 23mm, D = 152mm



**Stainless Steel Bended eye plate**

Item Code 078515	39 x 51mm
------------------	-----------



**Stainless Steel Diamond-shaped Eye plate**

Item Code	ø (mm)	Size (mm)
078520	5	37 x 59
078521	6	40 x 64
078522	8	50 x 80



**Stainless Steel Bended Eye Plate**

Item Code 078510	42 x 46mm
------------------	-----------



**Boat docking ring**

Item Code 072615	Ring Ø8mm
Item Code 072616	Boat docking ring for jetty, Stainless Steel 316 , Ø8mm, base 50x40mm



**Stainless Steel Sheet Eye Strap**

Item Code	W	W1
024260	42	10
024261	45	13
024262	48	16

Dims: (mm):	∅ Stay	∅ thread	C	D	L1	L2	breaking load
364900	2,5	5	5	5	122	182	850kg
365000	3	6	6	8	145	190	1500kg
365100	4	8	8	12	190	265	2200kg
365200	5	9,5	8,5	13	215	280	3300kg
365300	6	12	12	16	260	375	5300kg
365400	7	14	12	16	285	400	6500kg
365500	8	16	14	21	320	460	8900kg

**Stainless Steel Double-Toggle Tubular Turnbuckles**



Dims: (mm):	∅ Stay	∅ Thread	C	D	L1	L2	Breaking load(kg)
375100	4	8	8	8	160	230	2200
375200	5	10	8	10	180	260	3300
375300	6	12	8,5	12	225	325	5300
375500	8	16	12	16	300	440	8900

**Stainless Steel Tubular Turnbuckle with fork**

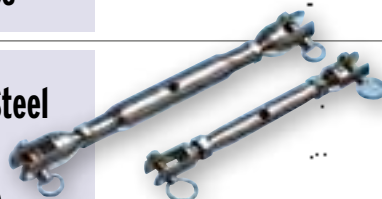

Dims: (mm):	∅	Length	Item Code	301000	6	20
Item Code 300100	5	10	Item Code 301100	6	22	
Item Code 300200	5	12	Item Code 301200	6	25	
Item Code 300300	5	15	Item Code 301300	7	15	
Item Code 300400	5	18	Item Code 301400	8	18	
Item Code 300500	5	20				
Item Code 300600	6	10	<b>Cotter Rings</b>			
Item Code 300700	6	12	Item Code 310100	∅ 13x1,0mm		
Item Code 300800	6	15	Item Code 310200	∅ 17x1,2mm		
Item Code 300900	6	18	Item Code 310300	∅ 18x1,5mm		

**Stainless Steel Key Bolts/ Cotter Rings**

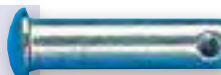

Dims: (mm):	Length	Bore
Item Code 370200 (A)	80	6
Item Code 370300 (B)	100	6
Item Code 370400 (C)	120	6
Item Code 370600 (D)	120	6
Item Code 370700 (E)	120	6

**Stainless Steel Tensioning Strips**

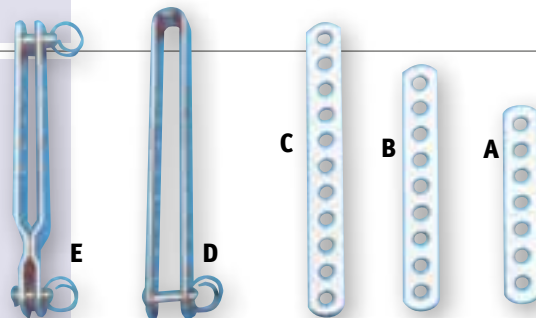

*stainless steel*  
**316**

Item Code 048050

H = 145mm, B = 115mm  
∅ base = 52mm, ∅ inside = 17x20mm

**Stainless Steel Cable Through Deck Lead**



with 2 or 3 wire holes. Diameter 25mm. Without base.  
Item Code 42193 H = 500mm, 2-holes (250 + 500mm)  
Item Code 42194 H = 550mm, 2-holes (275 + 550mm)  
Item Code 42197 H = 750mm, 3-holes (250 + 500 + 750mm)

∅ 8mm bore for locking screw, 35mm from base

**Stainless Steel Stanchions Tapered**



*stainless steel*  
**316**  
∅ 25mm  
Base dims. 64 x 90 x 58mm (lxwxh)  
Item Code 042185 Stanchion Base 85°  
Item Code 042190 Stanchion Base 90°

Bore: Pitch 60 x 35mm, ∅ M7

**Stainless Steel Stanchion Bases**





### Drop Fender

<b>Item Code 059641</b>	Silver	M1	Ø120x450mm
<b>Item Code 059642</b>	Silver	M2	Ø150x580mm
<b>Item Code 059643</b>	Silver	M3	Ø210x620mm
<b>Item Code 059644</b>	Silver	M4	Ø240x700mm
<b>Item Code 059645</b>	Silver	M5	Ø300x900mm

<b>Item Code 059651</b>	Dark Blue (Navy)	M1	Ø120x450mm
<b>Item Code 059652</b>	Dark Blue (Navy)	M2	Ø150x580mm
<b>Item Code 059653</b>	Dark Blue (Navy)	M3	Ø210x620mm
<b>Item Code 059654</b>	Dark Blue (Navy)	M4	Ø240x700mm
<b>Item Code 059655</b>	Dark Blue (Navy)	M5	Ø300x900mm

<b>Item Code 059661</b>	Black	M1	Ø120x450mm
<b>Item Code 059662</b>	Black	M2	Ø150x580mm
<b>Item Code 059663</b>	Black	M3	Ø210x620mm
<b>Item Code 059664</b>	Black	M4	Ø240x700mm
<b>Item Code 059665</b>	Black	M5	Ø300x900mm



### Fender „Orca“

<b>Item Code 059430</b>	White/Black	Size 1.	Ø100 x 450mm
<b>Item Code 059431</b>	White/Black	Size 2.	Ø140 x 530mm
<b>Item Code 059432</b>	White/Black	Size 3.	Ø200 x 630mm
<b>Item Code 059433</b>	White/Black	Size 4.	Ø300 x 800mm



### Fenders Drop Model "DUMPY"

<b>Item Code 059090</b>	White	Size 1.	Ø150 x 300mm
<b>Item Code 059091</b>	White	Size 2.	Ø180 x 360mm
<b>Item Code 059095</b>	Black	Size 1.	Ø150 x 300mm
<b>Item Code 059096</b>	Black	Size 2.	Ø180 x 360mm
<b>Item Code 059170</b>	Darkblue	Size 1.	Ø150 x 300mm
<b>Item Code 059171</b>	Darkblue	Size 2.	Ø180 x 360mm

**Item Code 059610** Spare Ball Valve (to be removed with M3 bolt or Parker-screw)

**Item Code 059612** Ball Valve Adapter – Inflating Pressure: 0,2bar (for all alpa fenders and buoy's)

**Item Code 269090** Valve Remover S.S. 316



<b>Item Code 059140</b>	Dark Blue (Navy)	M0	Ø 90x300mm
<b>Item Code 059141</b>	Dark Blue (Navy)	M1	Ø100x420mm
<b>Item Code 059142</b>	Dark Blue (Navy)	M2	Ø120x550mm
<b>Item Code 059143</b>	Dark Blue (Navy)	M3	Ø160x600mm
<b>Item Code 059144</b>	Dark Blue (Navy)	M4	Ø220x650mm
<b>Item Code 059145</b>	Dark Blue (Navy)	M5	Ø250x800mm
<b>Item Code 059146</b>	Dark Blue (Navy)	M6	Ø300x900mm

**Fender Comet  
Dark Blue  
(Navy)**



<b>Item Code 059160</b>	Silver	M0	Ø 90x300mm
<b>Item Code 059161</b>	Silver	M1	Ø100x420mm
<b>Item Code 059162</b>	Silver	M2	Ø120x550mm
<b>Item Code 059163</b>	Silver	M3	Ø160x600mm
<b>Item Code 059164</b>	Silver	M4	Ø220x650mm
<b>Item Code 059165</b>	Silver	M5	Ø250x800mm
<b>Item Code 059166</b>	Silver	M6	Ø300x900mm

**Fender Comet  
Silver**



<b>Item Code 059220</b>	Black	M0	Ø 90x300mm
<b>Item Code 059221</b>	Black	M1	Ø100x420mm
<b>Item Code 059222</b>	Black	M2	Ø120x550mm
<b>Item Code 059223</b>	Black	M3	Ø160x600mm
<b>Item Code 059224</b>	Black	M4	Ø220x650mm
<b>Item Code 059225</b>	Black	M5	Ø250x800mm
<b>Item Code 059226</b>	Black	M6	Ø300x900mm

**Fender Comet  
Black**



<b>Item Code 059200</b>	White	M0	Ø 90x300mm
<b>Item Code 059201</b>	White	M1	Ø100x420mm
<b>Item Code 059202</b>	White	M2	Ø120x550mm
<b>Item Code 059203</b>	White	M3	Ø160x600mm
<b>Item Code 059204</b>	White	M4	Ø220x650mm
<b>Item Code 059205</b>	White	M5	Ø250x800mm
<b>Item Code 059206</b>	White	M6	Ø300x900mm

**Fender Comet  
White**





### Solid Head Buoys

Item Code 059501	White	Size 1.	Ø350 x 480mm
Item Code 059502	White	Size 2.	Ø450 x 620mm
Item Code 059503	White	Size 3.	Ø550 x 730mm
Item Code 059504	White	Size 4.	Ø650 x 880mm

Item Code 059561	Dark Blue	Size 1.	Ø350 x 480mm
Item Code 059562	Dark Blue	Size 2.	Ø450 x 620mm
Item Code 059563	Dark Blue	Size 3.	Ø550 x 730mm
Item Code 059564	Dark Blue	Size 4.	Ø650 x 880mm

Item Code 059521	Black	Size 1.	Ø350 x 480mm
Item Code 059522	Black	Size 2.	Ø450 x 620mm
Item Code 059523	Black	Size 3.	Ø550 x 730mm
Item Code 059524	Black	Size 4.	Ø650 x 880mm

Item Code 059531	Yellow	Size 1.	Ø350 x 480mm
Item Code 059532	Yellow	Size 2.	Ø450 x 620mm
Item Code 059533	Yellow	Size 3.	Ø550 x 730mm
Item Code 059534	Yellow	Size 4.	Ø650 x 880mm

Item Code 059541	Orange	Size 1.	Ø350 x 480mm
Item Code 059542	Orange	Size 2.	Ø450 x 620mm
Item Code 059543	Orange	Size 3.	Ø550 x 730mm
Item Code 059544	Orange	Size 4.	Ø650 x 880mm

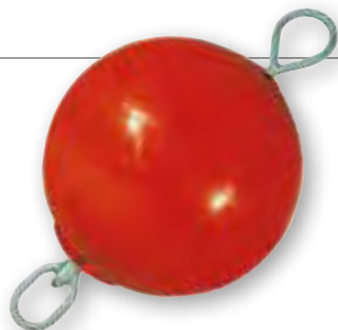

### Anchor Buoys

With through going zinc bar  
With nylon bearings and 2 Eyes

Item Code 059801	Yellow	Size 1.	Ø400 x 760mm
Item Code 059802	Yellow	Size 2.	Ø500 x 860mm
Item Code 059803	Yellow	Size 3.	Ø600 x 980mm

Item Code 059811	Red	Size 1.	Ø400 x 760mm
Item Code 059812	Red	Size 2.	Ø500 x 860mm
Item Code 059813	Red	Size 3.	Ø600 x 980mm

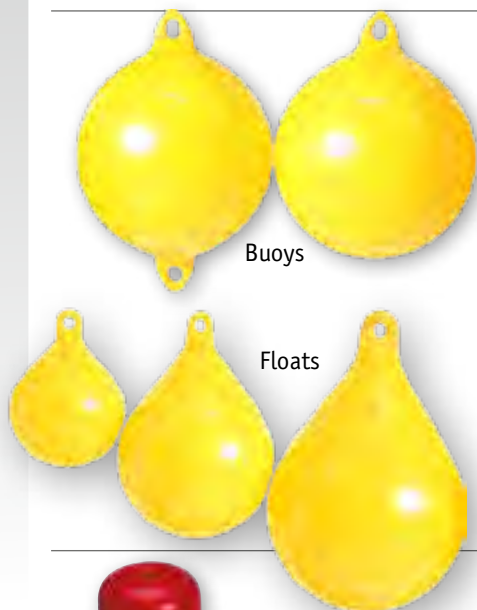

### Anchor Buoys (Marker Buoys)

Item Code 059080	Buoy Yellow	Size 1.	Ø350 x 400mm, 1 Eye
Item Code 059085	Buoy Yellow	Size 2.	Ø350 x 460mm, 2 Eyes

Item Code 059081	Buoy Red	Size 1.	Ø350 x 400mm, 1 Eye
Item Code 059086	Buoy Red	Size 2.	Ø350 x 460mm, 2 Eyes

Item Code 059060	Float Yellow	Size 1.	Ø150 x 200mm, 1 Eye
Item Code 059065	Float Yellow	Size 2.	Ø210 x 280mm, 1 Eye
Item Code 059070	Float Yellow	Size 3.	Ø260 x 360mm, 1 Eye

Item Code 059062	Float Red	Size 1.	Ø150 x 200mm, 1 Eye
Item Code 059068	Float Red	Size 2.	Ø210 x 280mm, 1 Eye
Item Code 059072	Float Red	Size 3.	Ø=260x360mm, 1 Eye



### Marker Float

#### Item Code N1800013

Red/White Plastic, 140 x 60mm,  
Hole Ø14mm. Also for swimming-pools.



### Bow Fender

Item Code 059030	White, 80 x 700mm
------------------	-------------------

Item Code 059035	Blue, 80 x 700mm
------------------	------------------

Item Code 059037	Black, 80 x 700mm
------------------	-------------------



<b>Item Code 059110</b> White	330 x 90mm
<b>Item Code 059115</b> Blue	330 x 90mm
<b>Item Code 059120</b> Black	330 x 90mm
<b>Item Code 059125</b> Darkblue	330 x 90mm

### Annular Fenders



Ladder Fender - 2-steps, 25 x 12 x 55cm – 3,0kg

<b>Item Code 059694</b> Dark Blue (navy)
<b>Item Code 059695</b> Black
<b>Item Code 059701</b> Blue

### Ladder Fenders



Ladder Fender - 3-steps, 25 x 12 x 75cm – 4,0kg

<b>Item Code 059696</b> Dark Blue (navy)
<b>Item Code 059697</b> Black
<b>Item Code 059702</b> Blue

Ladder Fender - 4-steps, 25 x 12 x 95cm – 5,0kg

<b>Item Code 059703</b> Blue
------------------------------

May be used as a bathing ladder.

Black Item Code	Dark Blue Item Code	Ø mm	Length m
020806	020906	6	2
020808	020908	8	2



### 16-Plait Mooring Ropes Handmade T16 + Splice

Landfasting of 100% Polyester (PES high strength).  
Split according to U.S. guidelines, preserving the force.  
Minimal water absorption of water, extremely UV resistant.

Black Item Code	Dark Blue Item Code	White Item Code	Ø mm	Length m	Ultimate Strength kg
020508	020608	020708	8	6.5	1870
020510	020610	020710	10	6.5	2240
020512	020612	020712	12	10	3410
020514	020614	020714	14	12	4350



3-Strand twisted polypropylene rope with eye splice

Black Item Code	Dark Blue Item Code	Ø	Length
60080451	60080452	8mm	4.5m
61004501	61004502	10mm	4.5m
61206501	61206502	12mm	6.5m
61410001	61410002	14mm	10m

### Mooring Rope



3-Strand twisted polypropylene rope with eye splice

Black Item Code	Dark Blue Item Code	Ø	Length
60080201	60080202	8mm	2m

### Fender Rope

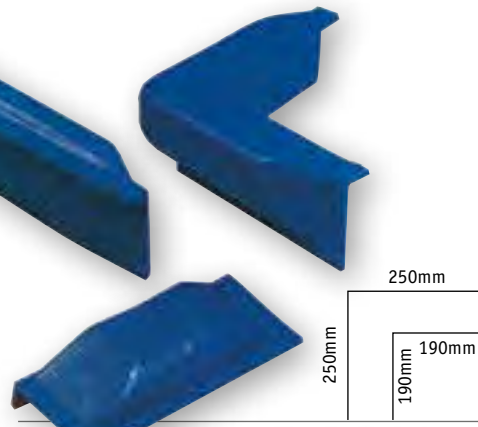

**Jetty Fenders**

Jetty Fender - straight, 60 x 500mm  
**Item Code 059040** Blue  
**Item Code 059041** Black  
**Item Code 059042** Dark Blue (navy)

Jetty Fender - straight, mini, 60 x 250mm  
**Item Code 059050** Blue

Jetty Fender - 90°, 60 x 500mm  
**Item Code 059045** Blue  
**Item Code 059046** Black  
**Item Code 059047** Dark Blue (navy)



**Multi Fenders**

Multi Fender, 60 x 30 x 8cm – 3,0kg  
 To apply in many different ways.  
 Connectable.



**Item Code 059704** Dark Blue (navy)  
**Item Code 059705** White  
**Item Code 059706** Black

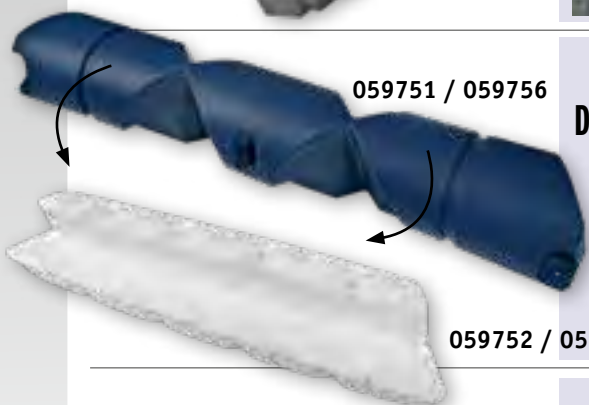

**Dock Fenders**

Dock Fender - 90°-mount, 100 x 19 x 19cm – 3,6kg  
**Item Code 059751** White  
**Item Code 059756** Dark Blue (navy)

Dock fender - straight, 110 x 24 x 24cm – 6,0kg  
**Item Code 059752** White  
**Item Code 059757** Dark Blue (navy)



**Block Fenders**

Block Fender - Size-1, 50 x12 x 7cm – 1,4kg  
**Item Code 059709** Dark Blue (navy)  
**Item Code 059710** Black  
**Item Code 059711** White

Block Fender - Size-2, 100 x12 x 7cm – 1,8kg  
**Item Code 059712** White  
**Item Code 059713** Dark Blue (navy)  
**Item Code 059714** Black



**Stainless Steel Fender Hook (AISI 316)**

Easy fixing and remaining  
 • Stainless steel base ø 40mm  
 • Eye ø15mm  
 • Supplied per pair  
 • For fenders of 10-25cm  
**Item Code 078783** Set of 2 x hook + 2 x base



**Spring Loaded Stainless Steel Fender Hook**

**Item Code 078773**  
 Spring loaded fender hook  
 3-Positions: open, line locked and closed  
 Practically flush when closed  
 Dims.: bore ø35mm, depth ± 60mm, outer ø47mm

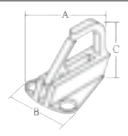

**Stainless Steel Fender Snap Hook**

**Item Code 078775**  
 Max. Rope ø15mm  
 Packing & Price per Pair. A = 42mm, B = 29mm, C = 33mm

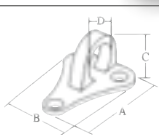

**Stainless Steel Fender Eye**

Packing & Price per Pair.  

Item Code	A mm	B mm	C mm	Rope Ø
<b>078780</b>	33	29	21	10mm
<b>078781</b>	50	34	29	17mm

Oblique Model for 2 Fenders

*stainless steel*  
outer dimensions  
**316**

	A	B	C	
<b>Item Code 048730L</b> Port	540	285	190mm	(Comet 3)
<b>Item Code 048730R</b> Starboard	540	285	190mm	(Comet 3)
<b>Item Code 048740L</b> Port	650	330	240mm	(Comet 4)
<b>Item Code 048740R</b> Starboard	650	330	240mm	(Comet 4)
<b>Item Code 048750L</b> Port	830	415	275mm	(Comet 5)
<b>Item Code 048750R</b> Starboard	830	415	275mm	(Comet 5)
<b>Item Code 048760L</b> Port	970	480	325mm	(Comet 6)
<b>Item Code 048760R</b> Starboard	970	480	325mm	(Comet 6)

Complete with Mounting Hardware for 25 and 30mm Tube  
All our baskets are fixed, not folding and therefor very sturdy

### Stainless Steel Fender Baskets

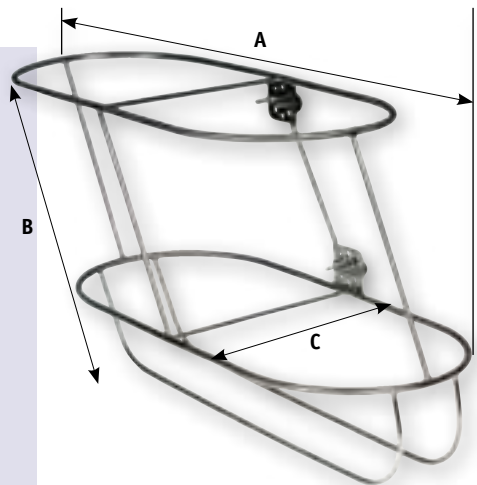

Upright model for 2 fenders

outer dimensions

	A	B	C	
<b>Item Code 048731</b>	375	320	190mm	(Comet 3)
<b>Item Code 048741</b>	475	320	240mm	(Comet 4)
<b>Item Code 048751</b>	540	430	275mm	(Comet 5)
<b>Item Code 048761</b>	640	465	325mm	(Comet 6)

Complete with Mounting Hardware for 25 and 30mm Tube  
All our baskets are fixed, not folding and therefor very sturdy

### Stainless Steel Fender Baskets

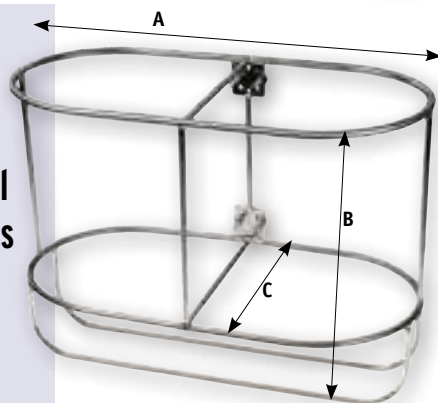

Upright Model for 1 Fender

A B

<b>Item Code 048631</b>	175	375mm	(Comet 3)
<b>Item Code 048641</b>	235	415mm	(Comet 4)
<b>Item Code 048651</b>	240	560mm	(Comet 5)
<b>Item Code 048661</b>	320	585mm	(Comet 6)

All our baskets are fixed, not folding and therefor very sturdy

**Item Code 048790** Optional Adapter for 25 and 30mm Tube  
also for the above baskets

### Stainless Steel Fender Baskets

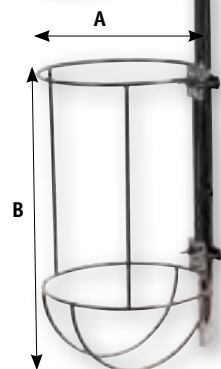

### 4U Fender hooks

Set of **4U fender hooks** for the railing.  
(Set = for a fender) Stainless steel 316.  
For the convenience of keeping the gangway free.

	Ø Railingsize
<b>Item Code 269080</b>	22mm
<b>Item Code 269081</b>	25mm
<b>Item Code 269082</b>	30mm

Ø Railingsize





**Vertical Windlass**



**Features**

- Luxury Stainless Steel 316 base
- Independent gypsy and drum operation
- Rope and chain combination gypsy
- Manual chain release
- Heavy Duty rated IP66 vertical electric motor
- Aluminum anodized gearhouse
- Manual override

**CAPSTAN IZMIR**  
For Boats up to 56' (17m)

Zadar Dimensions mm	A	B	C	D	E	F	G
Model 500W	90	75,5	18/40	265	90	175	122
Model 800W	90	75,5	18/40	265	90	175	122

Corse Dimensions mm	D	E	F	G	H	I	J	L
Model 500W	18/35	111	221	75,5	43	82	175	122
Model 700W	18/35	111	221	75,5	43	82	175	122

Izmir Dimensions mm	A	B	C	D	E	F
Model 800W	139	126	18/40	265	90	80

Low Profile	Zadar	Zadar	Corse	Corse	Capstan Izmir	Capstan Izmir
Motor	500W	800W	500W	700W	800W	800W
Voltage	12V	12V	12V	12V	12V	24V
Max. Linear Load	670kg	800kg	650kg	750kg	800kg	810kg
Lift Working Load	90kg	100kg	90kg	100kg	100kg	100kg
Amps. Work Load	60A	90A	60A	90A	90A	45A
Line Speed	23m/min	25m/min	23m/min	25m/min	25m/min	25m/min
Weight	12kg	13kg	9kg	10kg	11kg	11kg
Control Box	Included	Included	Included	Included	Included	Included
6mm, ISO 4565/DIN 766 10-12mm, 3-strand	Code 72802		Code 72812			
8mm, ISO 4565/DIN 766 12mm, 3-strand		Code 72804		Code 72814		
					Code 72819	Code 72820

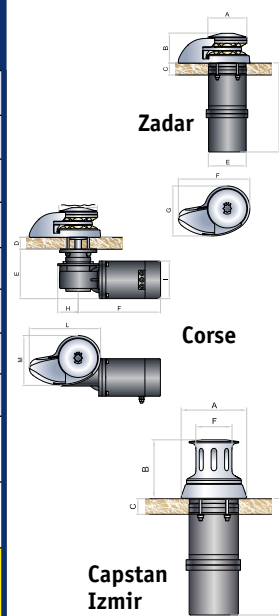

**Saint-Tropez**  
– Horizontal Windlass  
for Boats up to 33' (10m)



**Saint-Tropez Horizontal Windlass**

**Features**

- Luxury Stainless Steel 316 base
- Special waterproof Stainless Steel Ball Bearings
- Independent gypsy and drum operation
- Rope and chain combination gypsy
- Manual chain release
- Heavy Duty rated IP66 vertical electric motor
- Aluminum anodized gearhouse

Low Profile	Saint-Tropez	Saint-Tropez
Motor	500W	800W
Voltage	12V	12V
Max. Linear Load	670kg	800kg
Lift Working Load	90kg	100kg
Amps. Work Load	60A	90A
Line Speed	25m/min	28m/min
Weight	11kg	11kg
Control Box	Included	Included
6mm, ISO 4565/DIN 766 10-12mm, 3-strand	Code 72822	
8mm, ISO 4565/DIN 766 12mm, 3-strand		Code 72825



**Features Vertical Windlass SX-Serie**

- Compact round model
- Independent operation of chain drive and story head
- Manual freewheel chain
- Magnet chain counter installed as standard
- Heavy duty IP67 engine
- Anodized aluminum gearbox
- Stainless steel 316

**SX1 – Vertical windlass for boats 20-30' (6-9 m)**

SX1	SX1	SX1
Motor	<b>500W</b>	<b>800W</b>
Power supply	<b>12V</b>	<b>12V</b>
Maximum pull	630kg	700kg
Working load (amp)	95A	100A
Line speed	23m/min	25m/min
Max. line speed	26m/min	28m/min
Weight	11kg	13kg
Weight with drum	12kg	14kg
Control box	Included	Included
<b>Low Profile</b>		
6mm, ISO 4565/DIN 766	<b>Code 70710</b>	<b>Code 70715</b>
8mm, ISO 4565/DIN 766		<b>Code 70718</b>

**SX2 – Vertical windlass for boats 25-45' (7.5-13 m)**

SX2	SX2	SX2
Motor	<b>1000W</b>	<b>1500W</b>
Power supply	<b>12V</b>	<b>24V</b>
Maximum pull	1000kg	1500kg
Max. Workload	150kg	175kg
Working load (amp)	135A	75A
Line speed	20m/min	19m/min
Max. line speed	40m/min	40m/min
Weight	19kg	24kg
Weight with drum	20kg	25kg
Control box	Included	Included
<b>Low Profile</b>		
8mm, ISO 4565/DIN 766	<b>Code 70720</b>	<b>Code 70725</b>
<b>With drum</b>		
8mm, ISO 4565/DIN 766	<b>Code 70723</b>	<b>Code 70728</b>

**Vertical Windlass SX-Serie**



**SX3 – Vertical windlass for boats 50-60' (15-18 m)**

SX3	SX3	SX3
Motor	<b>1500W</b>	<b>1700W</b>
Power supply	<b>12V</b>	<b>24V</b>
Maximum pull	1000kg	1500kg
Max. Workload	150kg	
Working load (amp)	135A	75A
Line speed	20m/min	19m/min
Max. line speed	40m/min	40m/min
Weight	19kg	24kg
Weight with drum	20kg	25kg
Control box	Included	Included
<b>Low Profile</b>		
10mm, ISO 4565	<b>Code 70730</b>	
12mm, ISO 4565		<b>Code 70735</b>
<b>With drum</b>		
10mm, DIN 766		<b>Code 70737</b>
12mm, ISO 4565/ 13mm, DIN 766		<b>Code 70738</b>

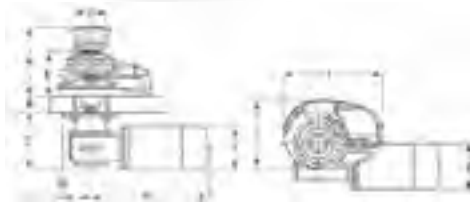

**X1  
Vertical  
Windlass**

X1-Dimensions mm	A	B	C	D	E	F	G	H	I	J	L
Model 500W	130	10-30	111	Ø 60	84	183	55	225	127	Ø 82	85
Model 800W	130	10-30	111	Ø 60	84	183	55	229	127	Ø 95	92

**X1 - Vertical Windlass for Boats 20-30' (6-9m)**

**Main features**

- Luxury chrome bronze base and drum
- Independent Gypsy & drum operation
- Rope and chain combination Gypsy
- Manual chain release
- Chain Counter pre-setting as standard
- Heavy duty rated IP67 motor
- Anodized aluminum gearbox

Motor Size	500W	800W
Power Supply	12V	12V
Max. Linear Load	630kg	700kg
Max. Lift Load	345kg	380kg
Lift Working Load	95kg	100kg
Amps Work Load	60A	110A
Line Speed	23m/min	25m/min
Max Line Speed	26m/min	28m/min
Net Weight Low Profile	11kg	13kg
Net Weight with Drum	12kg	14kg
Control Box	Included	Included
<b>X1</b>	<b>Low Profile</b>	
6mm, ISO 4565/DIN 766 10-12mm, 3-strand	<b>Code 72206</b>	<b>Code 72256</b>
8mm, ISO 4565/DIN 766 12mm, 3-strand	<b>Code 72228</b>	<b>Code 72278</b>
<b>X1</b>	<b>With Drum</b>	
6mm, ISO 4565/DIN 766 10-12mm, 3-strand	<b>Code 72216</b>	<b>Code 72266</b>
8mm, ISO 4565/DIN 766 12mm, 3-strand	<b>Code 72238</b>	<b>Code 72288</b>

**Accessories: See page 227-231**

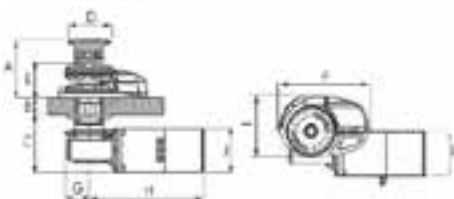

**X2  
Vertical  
Windlass**

X2-Dimensions mm	A	B	C	D	E	F	G	H	I	J	L
Model 800W	153	25-40	150	Ø 76	94	232	62	244	162	Ø 94	120
Model 1000W	153	25-40	150	Ø 76	94	232	62	250	162	Ø 114	138

**X2 - Vertical Windlass for Boats 25-45' (7,5-13m)**

**Main features**

- Luxury chrome bronze base and drum
- Independent Gypsy & drum operation
- Rope and chain combination Gypsy
- Manual chain release
- Heavy duty rated IP67 motor
- Anodized aluminum gearbox

Motor Size	800W	1000W	1000W
Power Supply	12V	12V	24V
Max. Linear Load	850kg	1000kg	1060kg
Max. Lift Load	460kg	500kg	530kg
Lift Working Load	115kg	150kg	160kg
Amps Work Load	110A	117A	59A
Line Speed	30m/min	25m/min	25m/min
Max Line Speed	35m/min	45m/min	45m/min
Net Weight Low Profile	21kg	23kg	23kg
Net Weight with Drum	23kg	24kg	24kg
Control Box	Included	Included	Included
<b>X2</b>	<b>Low Profile</b>		
6mm, ISO 4565/DIN 766	<b>Code 72301</b>	<b>Code 72321</b>	
8mm, ISO 4565/DIN 766	<b>Code 72302</b>	<b>Code 72322</b>	<b>Code 72342</b>
14mm, 3-strand		<b>Code 72323</b>	<b>Code 72343</b>
10mm, DIN 766			
<b>X2</b>	<b>With Drum</b>		
6mm, ISO 4565/DIN 766	<b>Code 72311</b>	<b>Code 72331</b>	
8mm, ISO 4565/DIN 766	<b>Code 72312</b>	<b>Code 72332</b>	<b>Code 72352</b>
14mm, 3-strand			
10mm, DIN 766		<b>Code 72333</b>	<b>Code 72353</b>

### Vertical Windlass X3 for Boats 50-60' (15-18m)

#### Main features

- Luxury chrome bronze base and drum
- Special watertight stainless steel ball bearing in the base
- Independent Gypsy and drum operation
- Chain Counter presetting as standard
- Rope and chain combination Gypsy
- Manual chain release and Manual override
- Rope chain combination Gypsy
- Heavy duty rated IP66 electric motor (X3)

Motor Size	<b>1700W</b>	<b>1700W</b>
Power Supply	<b>12V</b>	<b>24V</b>
Max. Linear Load	1600kg	1695kg
Max. Lift Load	800kg	850kg
Lift Working Load	200kg	215kg
Amps Work Load	135A	68A
Line Speed	15m/min	15m/min
Max Line Speed	32m/min	32m/min
Net Weight Low Profile	35kg	35kg
Net Weight with Drum	38kg	38kg
Control Box	Included	Included
<b>X3</b>	<b>Low Profile</b>	
8mm, ISO 4565/DIN 766, 14mm, 3-strand	<b>Code 72401</b>	
10mm, DIN 766, 16mm, 3-strand	<b>Code 72402</b>	<b>Code 72422</b>
12mm, ISO 4565/13mm, DIN 766	<b>Code 72403</b>	<b>Code 72423</b>
18mm, 3-strand		
<b>X3</b>	<b>With Drum</b>	
8mm, ISO 4565/DIN 766, 14mm, 3-strand	<b>Code 72411</b>	<b>Code 72431</b>
10mm, DIN766, 16mm, 3-strand	<b>Code 72412</b>	<b>Code 72432</b>
12mm, ISO 4565/13mm, DIN 766	<b>Code 72413</b>	<b>Code 72433</b>
18mm, 3-strand		



### X3 Vertical Windlass

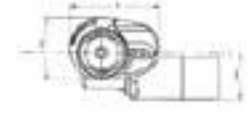
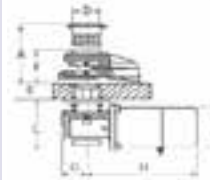

X3-Dimensions mm	A	B	C	D	E	F	G	H	I	J	L
Model 1700W	195	50-70	165	Ø 92	110	270	80	300	192	Ø 126	135

### X4 - Vertical Windlass for Boats 60-80' (18-24m)

#### Main features

- Luxury chrome bronze base and drum
- Special watertight stainless steel ball bearing in the base
- Independent Gypsy and drum operation
- Chain Counter presetting as standard
- Manual chain release
- Manual override
- Heavy duty rated IP44 electric motor (X4)

Motor Size	<b>2300W</b>	<b>2700W</b>
Power Supply	<b>24V</b>	<b>24V</b>
Max. Linear Load	2000kg	2400kg
Max. Lift Load	1000kg	1200kg
Lift Working Load	545kg	650kg
Amps Work Load	190A	200A
Line Speed	12m/min	15m/min
Max Line Speed	27m/min	29m/min
Net Weight Low Profile	72kg	75kg
Net Weight with Drum	82kg	85kg
Control Box	Included	Included
<b>X4</b>	<b>Low Profile</b>	
12mm, ISO 4565/13mm, DIN 766 ccw (counter clock wise)	<b>Code 72501</b>	<b>Code 72521</b>
<b>X4</b>	<b>With Drum</b>	
12mm, ISO 4565/13mm, DIN 766 cw (clock wise)	<b>Code 72511</b>	<b>Code 72531</b>
14mm cw (clock wise)		<b>Code 72532</b>
12mm, ISO 4565/13mm, DIN 766 ccw (counter clock wise)	<b>Code 72512</b>	



Accessories: See page 227-231



### X4 Vertical Windlass

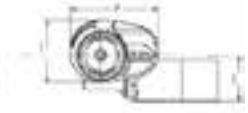

X4-Dimensions mm	A	B	C	D	E	F	G	H	I	J	k	l
Model 2300W	285	60-130	200	Ø125	150	380	140	445	220	Ø127	240	190
Model 2700W	285	60-130	200	Ø125	150	380	140	445	220	Ø127	240	190



**X5  
Vertical  
Windlass**

**X5 - Vertical Windlass for Boats 85-95' (25-29m)**

**Main features**

- Luxury stainless steel base and drum
- Independent Gypsy and drum operation
- Manual chain release
- Manual override
- Chain counter pre-setting as standard
- Heavy duty rated IP44 electric motor
- Anodized marine aluminum gearbox

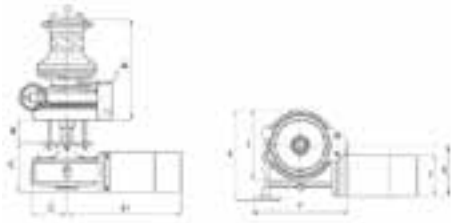

Motor Size	<b>3000W</b>	<b>Hydraulic</b>
Power Supply	<b>24V</b>	-
Max. Linear Load	2800kg	2500kg
Max. Lift Load	1400kg	1250kg
Lift Working Load	760kg	680kg
Amps Work Load	250A	-
Line Speed	12m/min	16m/min
Max Line Speed	30m/min	16m/min
Weight	100kg	55kg
Hydraulic Pressure	-	200bar
Hydraulic Flow	-	32l/min
Control Box	Included	Included
<b>X5</b>	<b>With Drum</b>	
12mm, ISO 4565/ 13mm, DIN 766	<b>Code 72611</b>	<b>Code 72621</b>
14mm	<b>Code 72612</b>	<b>Code 72622</b>

X5-Dimensions mm	A	B	C	D	E	F	G	I	J	K	L
Model 3000W	385	60-90	200	Ø132	332	140	445	264	Ø152	339	190

**Accessories: See page 227-231**



**T500-T700-  
T1000-T1500-  
T1700 - Capstans**

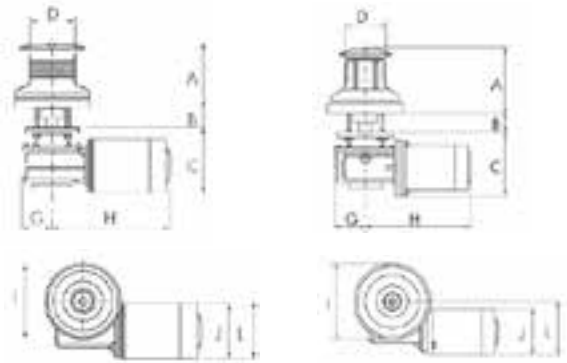

	<b>T500</b>		<b>T700</b>		<b>T1000</b>		<b>T1500</b>		<b>T1700</b>		
<b>Motor Size</b>	<b>500W</b>		<b>700W</b>		<b>1000W</b>		<b>1500W</b>		<b>1700W</b>		
<b>Power Supply</b>	<b>12V</b>	<b>12V</b>	<b>24V</b>	<b>12V</b>	<b>24V</b>	<b>12V</b>	<b>24V</b>	<b>12V</b>	<b>24V</b>	<b>12V</b>	<b>24V</b>
Max. Linear Load	670kg	850kg	900kg	1000kg	1060kg	1200kg	1270kg	1600kg	1695kg		
Max. Lift Load	335kg	460kg	490kg	500kg	530kg	600kg	635kg	800kg	850kg		
Lift Working Load	85kg	115kg	125kg	150kg	160kg	165kg	165kg	200kg	215kg		
Amps Work Load	60A	110A	55A	117A	59A	130A	65A	135A	68A		
Line Speed	20m/min	25m/min	25m/min	25m/min	25m/min	20m/min	20m/min	16m/min	16m/min		
Max Line Speed	25m/min	30m/min	30m/min	35m/min	35m/min	35m/min	35m/min	32m/min	32m/min		
Net Weight with Drum	11kg	15kg	15kg	21kg	21kg	27kg	27kg	30kg	30kg		
Control Box	Included	Included	Included	Included	Included	Included	Included	Included	Included		
<b>Item Code</b>	<b>71715</b>	<b>71720</b>	<b>71722</b>	<b>71725</b>	<b>71728</b>	<b>71730</b>	<b>71732</b>	<b>71735</b>	<b>71737</b>		

Capstan Dimensions (mm)	A	B	C	D	G	H	I	J	L	Length
Model T500	95	18-30	110	Ø 60	45	225	Ø115	Ø 82	85	30-40' (9-12m)
Model T700	140	20-40	140	Ø 92	65	240	Ø155	Ø 94	120	40-50' (12-15m)
Model T1000	140	20-40	140	Ø 92	65	242	Ø155	Ø114	120	45-55' (14-17m)
Model T1500	168	50-70	165	Ø104	80	270	Ø195	Ø114	134	55-65' (17-20m)
Model T1700	168	50-70	165	Ø104	80	300	Ø195	Ø126	134	65-75' (20-23m)

**T500-T700-T1000-T1500-T1700 - Capstans**

**Features**

- Luxury chrome bronze base and drum
- Heavy duty rated IP66 electric motor
- Anodized marine aluminum gearbox





**Horizontal Windlass ROYAL for Boats 25-40' (7,5-12m)**

**Main features**

- Dual Action Manual Windlass
- Marine aluminum anodized body
- Available in white polyester Coating
- Independent Gypsy and drum operation
- Manual chain release
- Manual override

Motor Size	Manual
Power Supply	-
Max. Linear Load	400kg
Max. Lift Load	200kg
Lift Working Load	50kg
Amps Work Load	-
Line Speed	-
Max. Line Speed	-
Weight	10kg
<b>ROYAL</b>	
6mm, ISO 4565 / DIN 766	<b>Code 70206</b>
8mm, ISO 4565 / DIN 766	<b>Code 70208</b>
10mm, DIN 766	<b>Code 70210</b>

Item Code 70250 spare handle  
Item Code 70251 spare 3-Spoke nut

**Horizontal Windlass ROYAL**

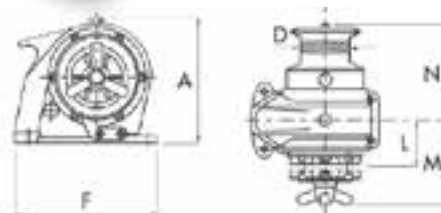

ROYAL	A	D	F	L	M	N
Dimensions mm	192	Ø 85	222	80	145	167

**Horizontal Windlass DORADO for Boats 20-35' (6-11m)**

**Main features**

- Marine aluminum anodized body
- Manual chain release
- Rope chain management by the spring load arm
- Heavy duty rated IP66 electric motor

Motor Size	<b>500W</b>	<b>800W</b>
Power Supply	<b>12V</b>	<b>12V</b>
Max. Linear Load	630kg	900kg
Max. Lift Load	345kg	490kg
Lift Working Load	95kg	125kg
Amps Work Load	60A	110A
Line Speed	23m/min	25m/min
Max. Line Speed	25m/min	27m/min
Weight	10kg	11kg
Control Box	Included	Included
<b>DORADO</b>		
6mm, ISO 4565 / DIN 766	<b>Code 70356</b>	<b>Code 70359</b>
10-12mm, 3-strand		
8mm, ISO 4565 / DIN 766	<b>Code 70357</b>	<b>Code 70358</b>
12mm, 3-strand		

DORADO Dimensions mm	Model	A	C	F	J	L	M	N
	500W	130	150	200	Ø 82	48	98	53
	800W	130	150	200	Ø 94	48	98	53



**Accessories: See page 227-231**

**Horizontal Windlass DORADO**

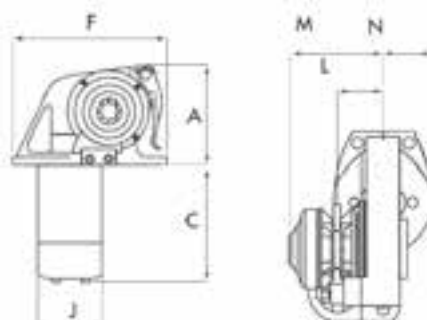



**Horizontale Windlass LION-1000 for Boats 25-35' (8-12m)**

**Main features**

- Marine aluminum anodized body
- Manual chain release
- Manual override
- Chain Counter Presetting as standard
- Rope chain management by the spring load arm
- Heavy duty rated IP66 electric motor

**Horizontal Windlass LION**

Motor Size	<b>700W</b>
Power Supply	<b>12V</b>
Max. Linear Load	575kg
Max. Lift Load	290kg
Lift Working Load	115kg
Amps Work Load	60A
Line Speed	23m/min
Max Line Speed	26m/min
Net Weight	11kg
Control Box	Included
<b>LION without automatic FREEFALL</b>	
6mm, ISO 4565/DIN 766	<b>Code 70470</b>
8mm, ISO 4565/DIN 766	<b>Code 70472</b>
<b>LION with automatic FREEFALL</b>	
6mm, ISO 4565/DIN 766	<b>Code 70474</b>
8mm, ISO 4565/DIN 766	<b>Code 70476</b>

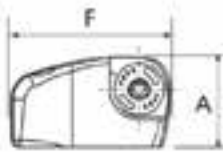
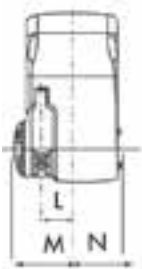

LION Dimensions mm Model 700W	A	F	L	M+N
	153	272	50	168

Accessories: See page 227-231



**Horizontale Windlass KOBRA for Boats 25-35' (7,5-11m)**

**Main features**

- Marine aluminum anodized body
- Independent Gypsy and drum operation
- Manual chain release
- Manual override
- Heavy duty rated IP66 electric motor

**Horizontal Windlass KOBRA**

Motor Size	1000W	1000W
Power Supply	12V	24V
Max. Linear Load	1250kg	1325kg
Max. Lift Load	625kg	665kg
Lift Working Load	160kg	170kg
Amps Work Load	117A	59A
Line Speed	25m/min	25m/min
Max Line Speed	35m/min	35m/min
Net Weight	21kg	21kg
Control Box	Included	Included
<b>KOBRA</b>		
8mm, ISO 4565/DIN 766	<b>Code 71328</b>	<b>Code 71388</b>
10mm, DIN 766	<b>Code 71330</b>	<b>Code 71340</b>

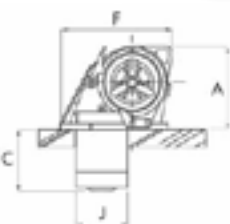

KOBRA Dimensions mm Model 1000W	A	C	F	D	J	L	M	N
	184	136	222	Ø 85	Ø114	83	147	172



**Horizontal Windlass CAYMAN  
for Boats 35-45' (11-14m)**

**Main features**

- Marine aluminum anodized body
- Independent Gypsy and drum operation
- Manual chain release
- Manual override
- Heavy duty rated IP66 electric motor

Motor Size	<b>1000W</b>	<b>1000W</b>
Power Supply	<b>12V</b>	<b>24V</b>
Max. Linear Load	1300kg	1375
Max. Lift Load	650kg	690kg
Lift Working Load	165kg	175kg
Amps Work Load	117A	59A
Line Speed	25m/min	25m/min
Max Line Speed	35m/min	35m/min
Net Weight	25kg	25kg
Control Box	Included	Included
<b>CAYMAN</b>		
8mm, ISO 4565 / DIN 766	<b>Code 70928</b>	<b>Code 70938</b>
10mm, DIN 766	<b>Code 70930</b>	<b>Code 70940</b>



**Horizontal  
Windlass  
CAYMAN**

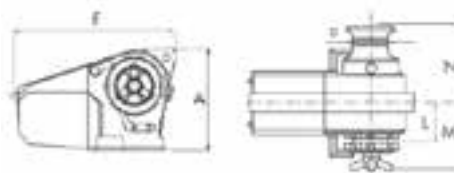

CAYMAN	A	D	F	L	M	N
Dimensions mm	230	Ø 85	370	85	150	175



**Accessories: See page 227-231**

**Horizontal Windlass TIGRES  
for Boats 40-55' (12-15m)**

**Main features**

- Marine aluminum anodized body
- Independent Gypsy and drum operation
- Manual chain release
- Manual override
- Heavy duty rated IP66 electric motor

Motor Size	<b>1500W</b>	<b>1500W</b>
Power Supply	<b>12V</b>	<b>24V</b>
Max. Linear Load	1500kg	1590kg
Max. Lift Load	750kg	795kg
Lift Working Load	190kg	200kg
Amps Work Load	130A	65A
Line Speed	20m/min	20m/min
Max Line Speed	35m/min	32m/min
Net Weight	28kg	28kg
Control Box	Included	Included
<b>TIGRES</b>		
10mm, DIN 766	<b>Code 71030</b>	<b>Code 71040</b>
12mm, ISO 4565 / DIN 766	<b>Code 71032</b>	<b>Code 71042</b>



**Horizontal  
Windlass  
TIGRES**

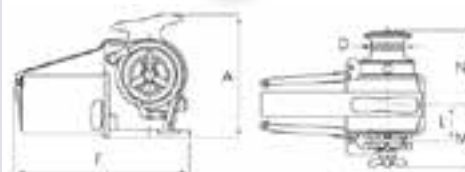

TIGRES	A	D	F	L	M	N
Dimensions mm	290	Ø 85	415	90	155	185



**Horizontal Windlass FALKON**

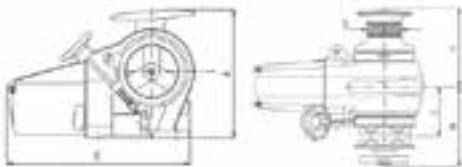

FALKON Dimensions mm Model 1700W	A	D	F	L	M	N
	345	Ø104	510	147	240	235

**Horizontal Windlass FALKON for Boats 40-55' (12-17m)**

**Main features**

- Marine aluminum anodized body
- Independent Gypsy and drum operation
- Manual chain release
- Manual override
- Heavy duty rated IP66 electric motor

Motor Size	<b>1700W</b>	<b>1700W</b>
Power Supply	<b>12V</b>	<b>24V</b>
Max. Linear Load	1700kg	1800kg
Max. Lift Load	850kg	900kg
Lift Working Load	215kg	225kg
Amps Work Load	135A	68A
Line Speed	16m/min	16m/min
Max Line Speed	32m/min	32m/min
Net Weight	55kg	55kg
Control Box	Included	Included
<b>FALKON</b>		
10mm, DIN 766	<b>Code 71130</b>	<b>Code 71140</b>
12mm, ISO 4565 / 13mm, DIN 766	<b>Code 71132</b>	<b>Code 71142</b>

Accessories: See page 227-231



**Horizontal Windlass TITAN-B**

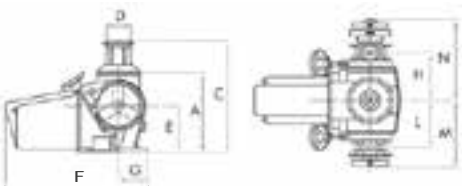

TITAN B Dimensions mm Model 2300W	A	C	F	D	L	M	N
	320	465	590	Ø 104	105	270	330

**Horizontal Windlass TITAN B for Boats 65-85' (20-26m)**

**Main features**

- Marine aluminum anodized body
- Independent Gypsy and drum operation
- Manual chain release
- Manual override
- Heavy duty rated IP66 electric motor

Motor Size	<b>2300W</b>
Power Supply	<b>24V</b>
Max. Linear Load	2700kg
Max. Lift Load	1500kg
Lift Working Load	430kg
Amps Work Load	140A
Line Speed	10m/min
Max Line Speed	16m/min
Net Weight	115kg
Control Box	Included
<b>TITAN-B</b>	
12mm, ISO 4565 / 13mm, DIN 766	<b>Code 71232</b>

**Remote Control Model THETIS 1002**

**Main features**

- hand Held Control
- Rechargeable Battery
- 4m Flex. Cable (3 Pole)
- Reversed Polarity Protection
- Parallel Connection
- Soft Rubber Case

Type	Wire
Number of Buttons	2
Voltage	10-30Vdc
Operative Temperature	-10°/+60°C
IP-Protection	IP67
Power Consumption	Max. 50mA
Weight	380gr
Dimensions	155x65x45mm
<b>THETIS 1002</b>	<b>Code 71980</b>



**Remote Control Model THETIS 5003 with Chain Counter**

**Main features**

- Hand Held Remote Control Chain Counter with LCD Display
- Switch On Button
- Automatic Release Function
- Reversed Polarity Protection
- 4m Flex. Cable (6 Pole)
- 5-Language Menu
- Display shows: Up Alarm – Speed – Amp. Draw – Release Chain – Voltage
- 8-Backlight Levels
- 8-Contrast Levels
- Sensor Detect Function
- Parallel Connection
- Soft Rubber Case

Type	Wire
Number of Buttons	3
Voltage	10-30Vdc
Operative Temperature	-10°/+60°C
IP-Protection	IP67
Power Consumption	Max. 50mA
Weight	450gr
Dimensions	155x65x45mm
<b>THETIS 5003</b>	<b>Code 71984</b>



**Remote Radio Control Model THETIS 7003 with Chain Counter**

**Main features**

- Radio Windlass Control with Chain Counter and LCD Display
- Rechargeable lithium-ion Battery with 12V Adapter
- Switch On Button
- Reversed Polarity Protection
- 5-Language Menu
- Display shows: Up Alarm - Speed - Amp. Draw - Release Chain - Voltage
- 8-Backlight Levels
- 8-Contrast Levels
- Sensor Detect Function
- Parallel Connection
- Soft Rubber Case

Type	Remote
Number of buttons	3
Frequency	868-870MHz
Range	20-30m
Voltage	10-30 Vdc
Operative Temperature	0°/+70°C
IP-Protection	IP66
Power Consumption@ no load	Max. 50mA
Weight Transmitter	100gr
Dim. Transmitter	145x 50x20mm (lxwxh)
Weight Receiver	350gr
Dimensions Receiver	150x110x75mm (lxwxh)
Max. chain length	999m of 999'
<b>THETIS 7003</b>	<b>Code 71986</b>



**Remote Control Model IRIS 2 with Chain Counter**

**Main features**

- Cockpit / Fly Bridge Chain Counter with LCD Display
- Switch On Button
- Automatic Release Function
- Reversed Polarity Protection
- 5-Language Menu
- Display shows Up alarm – Speed – Amp. Draw – Release Chain – Voltage
- 8-Backlight Levels
- 8-Contrast Levels
- Sensor Detect Function
- Parallel Connection

Type	Built-in
Number of Buttons	3
Voltage	10-30Vdc
Operative Temperature	-10°/+60°C
IP-Protection	IP67
Power Consumption	5mA-40mA
Weight	250gr
Dimensions	110x105x15mm
<b>IRIS 2</b>	<b>Code 71988</b>





### Lofrans Remote Control EV040

De magneetsensorkit wordt meestal geleverd bij de ankerlier. Indien dit niet het geval is dan bestel art. 149108

#### Remote Radio Control Model EV040 with Chain Counter

##### Main features

- Radio Windlass Control with Chain Counter and LCD Display
- Rechargeable lithium-ion Battery with 12V Adapter
- Switch On Button
- Reversed Polarity Protection
- 5-Language Menu
- Display shows:  
Up Alarm - Speed - Amp. Draw - Release Chain - Voltage
- 8-Backlight Levels
- 8-Contrast Levels
- Sensor Detect Function
- Parallel Connection
- Soft Rubber Case

Type	Remote
Number of buttons	3
Frequency	868-870MHz
Range	20-30m
Voltage	10-30 Vdc
Operative Temperature	0°/+70°C
IP-Protection	IP66
Power Consumption@ no load	Max. 50mA
Weight Transmitter	100gr
Dim. Transmitter	145x 50x20mm (lwxhx)
Weight Receiver	350gr
Dimensions Receiver	150x110x75mm (lwxhx)
Max. chain length	999m of 999'
<b>EV040</b>	<b>Code 149004</b>



### Radio Remote Control

#### Item Code 149002

Radio remote control for windlasses, bow- and stern thrusters, cranes and gangways.

- Protection IP67
- 2 Channels
- 433mHz or 868mHz
- Dims. 98x52x26mm (lwxhx)



### Thermal Circuit Breakers

Type	Automatic	Automatic
Ampere	35A	70A
Windlass Motors 12V	250/400W	700W
Windlass Motors 24V	700W	1000-1500W
<b>Circuit Breakers</b>	<b>Code 71800</b>	<b>Code 71804</b>



### Remote Control

Description	UP	DOWN
Color	RED	GREY
Voltage	10-30Vdc	10-30Vdc
Operative Temp.	-10°/+60°C	-10°/+60°C
IP-Protection	IP67	IP67
Max. Amps	5A	5A
Construction	Plastic	Plastic
Dimensions	-	-
Foot Switch	<b>Code 180003</b>	<b>Code 180002</b>



### Remote control „Storm“

The Storm-6 remote control can handle up to 8 transmission channels. Frequency mode 2400 Mhz, 12-24V. Ideal for long-range use, it allows the management of complex applications such as davits and gangways.

#### Item Code 149009

Transmitter	Storm TX-6	Receiver	RX
Number of buttons	8	Number of relays	11
Battery	2x1.5V AAA/LR03	Voltage	12-24V DC
Aan/uit-knop	Ja	Digital ports	8
Dimensions	66 x114 x 37,5mm	Dimensions	120x117x51mm
Weight	135gr	Weight	400gr
Protection	IP-67	Protection	IP66
Output power: <10mW / Range: 60m in open air			
Current consumption receiver 0,02A (12V) – 0,03A (24V)			
Radio communication: Simplex. / Max. number of registered transmitter: 8			
Frequency: 2405-2480 Mhz - 16 channels			
Antenna receiver: internal. / Prepared for external antenna (RP-SMA connector)			
Temperature range: -20 to +55 °C			





Lofrans Remote Control



**Radio Remote Control**

**Main features**

- Radio Remote Control
- Digital recognition avoids accidental activation of other System
- Zero power consumption when in standby mode (transmitter)
- Easy to install and set up, simple to use
- Transmitter handles up to 8 channels
- Receiver handles 4 channels
- Set (Item Code 71983) comes with Transmitter & Receiver
- Soft Rubber Case

	Transmitter	Receiver
Type	Remote	-
Number of Buttons	8	-
Number of Channels	8	4
Voltage	2x3V(CR2430)	
Lithium Batteries	12 or 24Vdc	
Operative Temperature	-15°/+55°C	-15°/+55°C
Frequency	868 Mhz	868 Mhz
IP-Protection	IP67	
Max. Amps	5A	
Weight	80gr	110g
Dimensions	114x60x22mm	125x78x21mm
Range	20-30m	20-30m
<b>Radio Remote Control</b>	<b>Item Code 71983</b>	
<b>Extra Receiver</b>	<b>Item Code 71990</b>	



Lofrans Remote Control



**Foot Switches**

**Main features**

- Stainless Steel base • Composite grey Cover
- Special Marine Grade Rubber UV-Resistant Button

Description	UP	DOWN	WASH DOWN
Color	RED	BLACK	BLUE
Voltage	10-30Vdc	10-30Vdc	10-30Vdc
Operative Temp.	-10°/+60°C	-10°/+60°C	-10°/+60°C
IP-Protection	IP67	IP67	IP67
Max. Amps	5A	5A	5A
Weight	100gr	100gr	100gr
Dimensions	80x95x20mm	80x95x20mm	80x95x20mm
<b>Foot Switch</b>	<b>Code 71979</b>	<b>Code 71978</b>	<b>Code 71977</b>

251035/R

Lofrans Remote Control



251035/N



449900



180002



180003

Description	SET UP/DOWN	UP	DOWN	UP	DOWN
Color	BLACK	RED	GREY	RED	GREY
Voltage	10-30Vdc	10-30Vdc	10-30Vdc	10-30Vdc	10-30Vdc
Operative Temperature	-10°/+60°C	-10°/+60°C	-10°/+60°C	-10°/+60°C	-10°/+60°C
IP-Protection	IP67	IP67	IP67	IP67	IP67
Max. Amps	5A	5A	5A	5A	5A
Construction	Plastic/ Stainless	Stainless Steel	Stainless Steel	Plastic	Plastic
Dimensions	Ø75/H=85mm	Ø79/Pitch 65mm	Ø79/Pitch 65mm	-	-
<b>Foot Switch</b>	<b>Code 449900</b>	<b>Code 251035/R</b>	<b>Code 251035/N</b>	<b>Code 180003</b>	<b>Code 180002</b>



Type	Toggle Switch	Toggle Switch
Positions	Up-Off-Down	Up-Off-Down
Voltage	10-30Vdc	12 & 24Vdc
Operative Temperature	-10°/+60°C	-10°/+60°C
Max. Power	-	2500W/12&24V
Max. Contacts Amps	5A	-
<b>Control Switch</b>	<b>Code 71803</b>	<b>Code 449910</b>

### allpa/Lofrans Control Switches



Type	Automatic	Automatic	Automatic
Ampere	35A	70A	100A
Windlass Motors 12V	250/400W	700W	1000/1200W
Windlass Motors 24V	700W	1000-1500W	2000W
<b>Circuit Breakers</b>	<b>Code 71800</b>	<b>Code 71804</b>	<b>Code 71805</b>



### Lofrans Thermal Circuit Breakers



Type	Automatic	Automatic	Automatic	Automatic	Automatic
Ampere	60A	80A	100A	135A	175A
Windlass Motors 12V	300-700W	700-900W	900/1000W	1000/1700W	1500/2000W
Windlass Motors 24V	500-1000W	700-1000W	1000-1700W	1500-2000W	2500-3000W
<b>Circuit Breakers</b>	<b>Code 449920</b>	<b>Code 449925</b>	<b>Code 449930</b>	<b>Code 449935</b>	<b>Code 449940</b>

### allpa Thermal Circuit Breakers



No. of Terminals	3	3	3	4	4	4
Power	12V	24V	24V	12V	12V	24V
Windlass Motors	500-1700W	500-1700W	1700-2300W	500-1000W	1000-1700W	500/1700W
<b>Control Boxes</b>	<b>Code 71790</b>	<b>Code 71791</b>	<b>Code 71792</b>	<b>Code 71795</b>	<b>Code 71793</b>	<b>Code 71794</b>

### Lofrans Solenoid Control Boxes



## Lofrans Gypsies & Maintenance Kits

Model Windlass	X1	X2	X3	X4	X5	ATLAS	ROYAL	DORADO	KOBRA	CAYMAN	TIGRES	FALKON
Code maintenance kit	71770	71771	71772	n.n.b	n.n.b.	71773	71774	71775	71776	71776	71777	71778
Gypsy 6mm, ISO 4565/ DIN 766	71860	71406	-	-	-	71432	71436	71442	71436	71436	71436	-
Gypsy 8mm, ISO 4565/ DIN 766	71402	71408	71972	71420	-	71434	71438	71444	71438	71438	71438	71420
Gypsy 10mm, DIN 766	-	71410	049989	71422	-	-	71439	-	71439	71439	71439	71422
Gypsy 10mm, ISO 4565	-	-	71412	71424	-	-	71440	-	71440	71440	71440	71424
Gypsy 12mm, ISO 4565/13mm, DIN 766	-	-	71967	71426	71430	-	-	-	-	-	71966	71426
Gypsy 13mm, DIN 764	-	-	-	-	-	-	-	-	-	-	-	71427
Gypsy 14mm	-	-	-	71428	-	-	-	-	-	-	-	71428
Chain sensor kit	149108	149108	149108	149108	149108	149108	149108	149108	149108	149108	149108	149108

### Schelde Anchors



### Schelde Anchor

Anchor with great holding power, easy to use.

Galvanized	
Code 072804	4kg
Code 072806	6kg
Code 072810	10kg
Code 072816	16kg
Code 072820	20kg
Code 072825	25kg
Code 072832	32kg
Code 072840	40kg

Stainless Steel	
Code 072854	4kg
Code 072856	6kg
Code 072860	10kg
Code 072866	16kg
Code 072870	20kg



### Floating Anchor



### Floating Anchor

Floating anchor made of nylon. Easy to store.

Item Code 015060 Ø 60cm for boats till 8m  
Item Code 015080 Ø 80cm for boats till 12m

### GUARDIAN Anchors



### Guardian UTILITY ANCHORS

### GUARDIAN Anchors by Fortress®.

Guardian Lightweight Anchors are manufactured from hardened Aluminum-Magnesium Alloy, makes them stronger and lighter than competitive steel anchors.

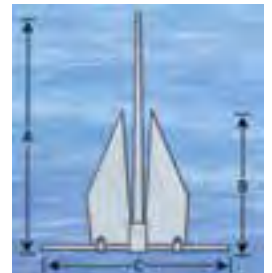

	Guardian		Dims (mm)			Boat Length	Hard sand	Soft mud
			A	B	C			
Code 072450	G-5	1,1 kg	483	179	406	4-5m	476kg	95kg
Code 072451	G-7	1,3 kg	599	330	457	5-7m	782kg	156kg
Code 072452	G-11	2,2 kg	635	381	508	7-8m	1.021kg	204kg
Code 072453	G-16	3,8 kg	737	432	584	8-10m	1.463kg	293kg
Code 072454	G-23	5,9 kg	838	483	686	10-12m	2.211kg	442kg
Code 072455	G-37	8,1 kg	965	559	787	12-14m	3.402kg	680kg

### Fortress® Anchors

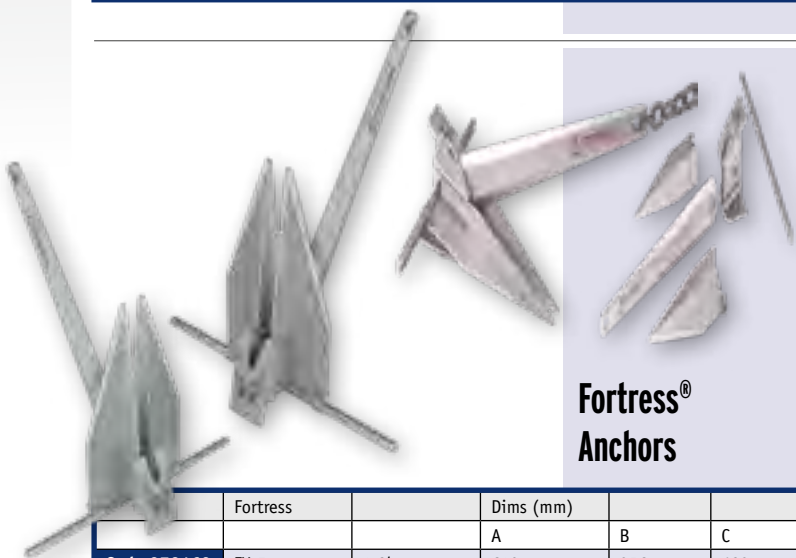

### FORTRESS MARINE ANCHORS

### FORTRESS® adjustable aluminium anchors.

Lightweight adjustable aluminum Anchors, non magnetic and corrosion proof. Adjustable fluke angle from 32° to 45° increases holding power in soft mud up to 400%!

Carrier bags available. FORTRESS Anchors are Type Approved by the American Bureau of Shipping (ABS).



	Fortress		Dims (mm)			Boat Length	Hard sand	Soft mud		Replaces Steel Anchors
			A	B	C			32°	45°	
Code 072460	FX-7	1,8kg	610	356	483	5-8m	1.270kg	381kg	191kg	3-4kg
Code 072461	FX-11	3,2kg	686	406	559	8-10m	1.633kg	490kg	245kg	5-6kg
Code 072462	FX-16	4,5kg	787	457	635	10-12m	2.268kg	680kg	340kg	6-8kg
Code 072463	FX-23	6,8kg	914	533	737	12-14m	3.629kg	1.089kg	544kg	9-13kg
Code 072464	FX-37	9,5kg	1016	610	813	14-15m	5.443kg	1.633kg	816kg	15-23kg
Code 072465	FX-55	14,4kg	1168	686	940	16-18m	7.258kg	2.177kg	1.089kg	23-29kg
Code 072466	FX-85	21,2kg	1295	762	1041	18-21m	9.536kg	2.858kg	1.429kg	31-41kg
Code 072467	FX-125	31,1kg	1422	838	1143	21-46m	12.247kg	3.674kg	1.837kg	45-77kg

Code	L (cm)	B (cm)	D (cm)	H (cm)
048816	56	39	15	34
048820	56	39	15	36
048825	56	39	15	37
048830	56	39	15	37
048835	56	39	15	38
048840	56	40	15	42

- Item Code 048816 16kg For boats up to ± 3800kg
- Item Code 048820 20kg For boats up to ± 4500kg
- Item Code 048825 25kg For boats up to ± 9000kg
- Item Code 048830 30kg For boats up to ± 12000kg
- Item Code 048835 35kg For boats up to ± 18000kg
- Item Code 048840 40kg For boats up to ± 25000kg

**Pool Anchors  
Made of High  
Polished  
Stainless Steel**

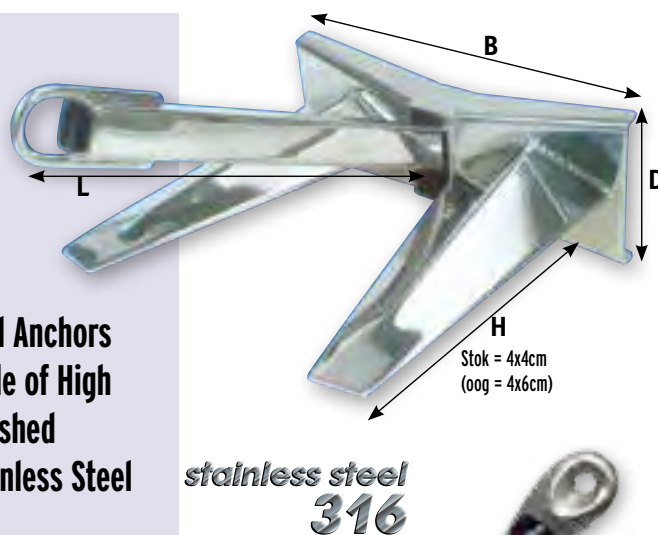

**Folding Grapnels. Zinc Steel**

- Item Code 916001 1,5kg
- Item Code 916002 2,5kg
- Item Code 916003 3,2kg
- Item Code 916004 4,0kg
- Item Code 916006 6,0kg
- Item Code 916008 8,0kg
- Item Code 916010 10,0kg
- Item Code 916012 12,0kg
- Item Code 916015 15,0kg

**Folding Grapnels**



**Zinc Steel**

- Item Code 020050 5,0kg
- Item Code 020075 7,0kg
- Item Code 020090 9,0kg
- Item Code 020120 12,0kg
- Item Code 020160 16,0kg
- Item Code 020210 21,0kg
- Item Code 020270 27,0kg
- Item Code 020350 35,0kg



**Plough Anchors  
Type CQR**



**Zinc Steel**

	A	B	C	D
Item Code 010025 2.5kg	435mm	365mm	70mm	100mm
Item Code 010040 4.0kg	480mm	425mm	70mm	100mm
Item Code 010060 6.0kg	495mm	455mm	90mm	125mm
Item Code 010080 8.0kg	580mm	465mm	95mm	125mm
Item Code 010100 10.0kg	590mm	520mm	116mm	130mm
Item Code 010120 12.0kg	670mm	605mm	120mm	130mm
Item Code 010150 15.0kg	765mm	625mm	120mm	130mm
Item Code 010200 20.0kg	870mm	675mm	130mm	160mm
Item Code 010250 25.0kg	893mm	760mm	130mm	160mm

**"DANFORTH"-  
Type Anchors**

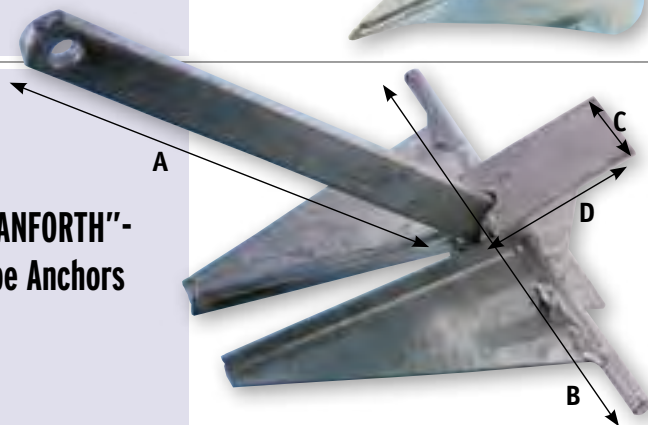

	L
Item Code 072305 5,0kg	470mm
Item Code 072307 7,5kg	530mm
Item Code 072310 10,0kg	600mm
Item Code 072313 13,0kg	600mm
Item Code 072315 15,0kg	670mm
Item Code 072320 20,0kg	715mm
Item Code 072330 30,0kg	815mm
Item Code 072340 40,0kg	915mm

**Stainless Steel  
Anchors**



	L
Item Code 072405 5,0kg	420mm
Item Code 072407 7,5kg	470mm
Item Code 072410 10,0kg	530mm
Item Code 072415 15,0kg	610mm
Item Code 072420 20,0kg	580mm
Item Code 072440 40,0kg	830mm

**Zinc Steel  
Anchors**

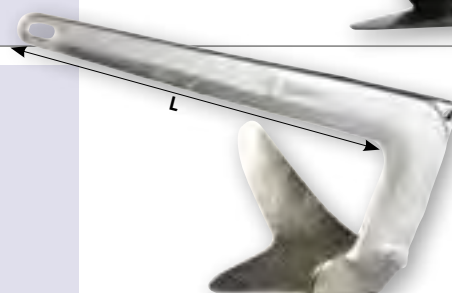

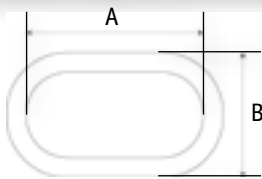
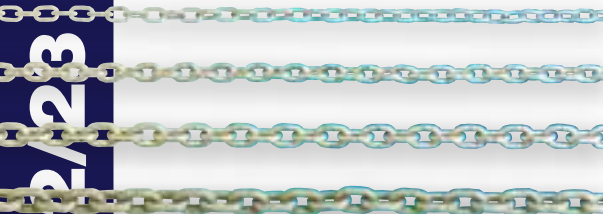

**Galvanized Anchor Chain DIN766**

Item Code	001006	001008	001010	001013	001012-ISO
	6mm	8mm	10mm	13mm	12mm
Working load	450kg	800kg	1250kg	1900kg	1900kg
Weight kg/m	0.80kg	1.40kg	2.20kg	3.03kg	3.03kg
Length per kg	1.25m	0.68m	0.46m	0.33m	0.33m
Supplied per	50m	50m	50m	50m	50m
A (mm)	18,5	24	28	36	36
B (mm)	20	26	34	44	40

**Stainless Steel Anchor Chain DIN766**

Item Code	024006	024008	024010
	6mm	8mm	10mm
Working load	1400kg	2500kg	3400kg
Weight kg/m	0.80kg	1.40kg	2.20kg
Length per kg	1.25m	0.68m	0.46m
Supplied per	50m	50m	50m
A (mm)	18,5	24	28
B (mm)	20	27	34



**Chain Connector**

Emergency chain connector, galvanized

- Item Code 024370** 6mm
- Item Code 024371** 8mm
- Item Code 024372** 10mm
- Item Code 024373** 12mm



**Leaded Anchor Rope**

Braided polyester anchor rope with leaded part. With S/S thimble and splice. Kink-free, pre-stretched and resistant against sunlight. Supplied on reel. Color: dark blue.

- Item Code 61030005** Leaded anchor rope 10mm x 30m  
Leaded part 10m. Weight 3.9kg. Breaking load: 800kg
- Item Code 61235005** Leaded anchor rope 12mm x 35m  
Leaded part 10m. Weight 5.6kg. Breaking load: 1150kg
- Item Code 61440005** Leaded anchor rope 14mm x 40m  
Leaded part 10m. Weight 8.7kg. Breaking load: 1650kg
- Item Code 61650005** Leaded anchor rope 16mm x 50m  
Leaded part 10m. Weight 13.6kg. Breaking load: 2100kg



**Anchor Rope**

Standard length 30m Braided (not twisted) polyester, white, with thimble & splice Packing per piece

- Item Code 60830000** 8mm Breaking load: 800kg
- Item Code 61030000** 10mm Breaking load: 1200kg
- Item Code 61230000** 12mm Breaking load: 1900kg
- Item Code 61430000** 14mm Breaking load: 2500kg

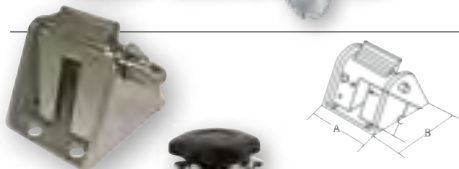

**Stainless Steel Chain Stopper**

**Item Code 078740**  
No chain tension on windlass With foot pedal for easy and safe release of the anchor chain  
Dims. A = 68mm, B = 79mm, C = 40mm, D = 14mm

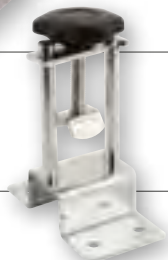

**Anchor Blockage**

**Item Code 489007** 138 x 70 x 172mm (lxbxh)



**Spare Rollers For S/S Anchor Bow  
Rollers for chain & rope**

- Item Code 489020** Ø=54mm, B=48mm
- Item Code 489021** Ø=54mm, B=62mm
- Item Code 489022** Ø=70mm, B=62mm

**Item Code 072600** for chain 6-8mm  
**Item Code 072601** for chain 10-13mm

### Stainless Steel Anchor Chain Guider Pipe



**Item Code 072635** Through deck lead

### Stainless Steel Through Deck Lead for Ropes etc.

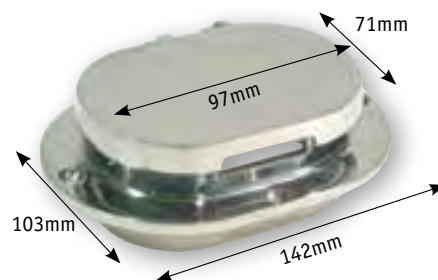

Item Code	A	B	C	Material thickness	Weight	Anchor size
	mm	mm	mm	mm	kg	kg
<b>489051</b>	150	50	65	2	0.4	7.5
<b>489052</b>	200	50	65	2	0.5	7.5
<b>489053</b>	250	50	65	2	0.6	10

*stainless steel*  
**316**

### Universal Anchor Bow Rollers Stainless Steel

Suitable for all types of anchors



Item Code	A	B	C	Material thickness	Weight	Anchor size
	mm	mm	mm	mm	kg	kg
<b>489054</b>	300	80	80	3	2.5	10
<b>489055</b>	400	80	80	3	2.8	15
<b>489056</b>	550	80	80	3	3.4	20

*stainless steel*  
**316**

### Anchor Bow Rollers Stainless Steel

Suitable for sand anchors:  
CQR, Delta, SOC

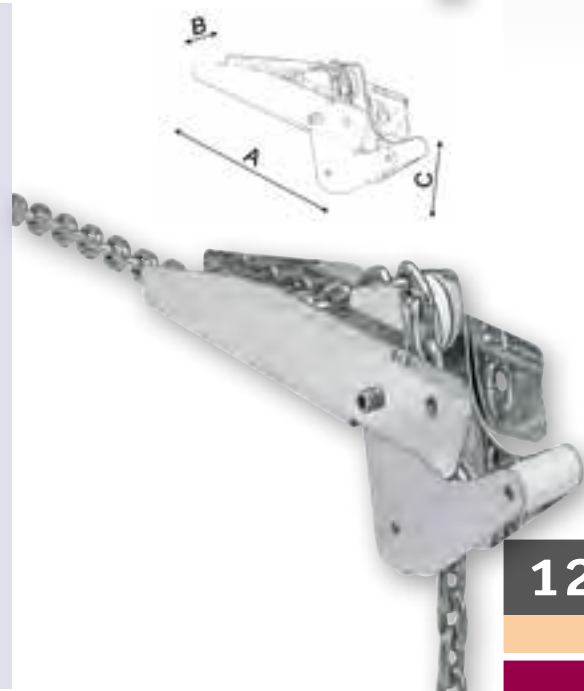

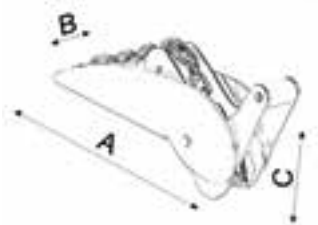

**Anchor Bow Rollers  
Stainless Steel**  
Anchor Bow Rollers  
Stainless Steel

Item Code	A	B	C	Material Thickness	Weight	Anchor size
	mm	mm	mm	mm	kg	kg
489070	330	70	117	4	3	10
489071	400	70	117	4	4.5	15
489072	495	90	150	5	6.5	20
489073	595	90	150	5	7.5	30
489074	695	90	150	5	8	30

*stainless steel*  
**316**

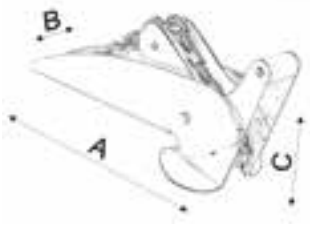

**Anchor Bow Rollers  
Stainless Steel**  
Suitable for sand and rock anchors: Bruce, Trefoil, CQR, SOC, Delta, Brittany & Danforth

Item Code	A	B	C	Material Thickness	Weight	Anchor size
	mm	mm	mm	mm	kg	kg
489080	330	71	100	4	3.7	20
489081	440	71	100	4	3.9	20
489082	490	71	100	4	4.4	20
489083	540	90	100	5	6.4	30
489084	600	90	100	5	6.8	30
489085	650	90	100	5	7	30

*stainless steel*  
**316**



**Stainless Steel Revolving Anchor Joint Model "FORCE"**

This anchor joint revolves automatically on the right side when it is pulled in the stem of the hawse-hole. The fork side is connected to the anchor chain. The opposite side is connected with a shackle to the anchor.

**Item Code 024020** for chain Ø6-8mm, breaking load: 3000kg  
**Item Code 024021** for chain Ø8-10mm, breaking load: 6000kg

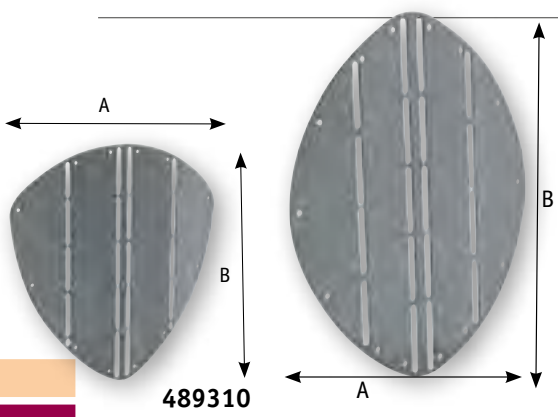

**Stainless Steel Bow Protector**

Highly polished stainless steel bow protector. Available in two models. Protects the bow against the anchor. Simply to mould by hand on every kind of bow thanks to the split cuts in the stainless steel plate. Easy to fix, light weighted and hard protection! Patented model. Material thickness 1.5mm.

**Item Code 489300** Bow protector ellipse shape, A x B 265 x 345mm, weight 0,71kg  
**Item Code 489310** Bow protector triangle shape, A x B 350 x 345mm, weight 0,95kg



**Item Code 008005**  
 Approved black nylon 2-piece anchor ball.  
 Dims.: Ø350mm. Weight 500 gr.

**Black Anchor Ball**

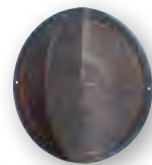

**Item Code N6200500**  
 Soft plastic container for winch handle or small grapnel anchor  
 Soft plastic, white. Dims.: Inside 7x7cm, L = 30cm  
 Suitable for grapnel anchor 1,5 kg (Item Code 916001)

**Plastic Sleeve**



**Item Code 078380** Fixed Link, small  
**Item Code 078381** Fixed Link, large  
**Item Code 078382** Swivelling Link, small  
**Item Code 078383** Swivelling Link, large  
**Item Code 078384** Swivelling Link, large  
**Item Code 078385** Swivelling Link, double

**Stainless Steel Chain Links**



Item Code	A mm	B mm	C mm	D mm	E mm	Max. load
078380	78	15	9	37	25	850kg
078381	90	22	13	43	28	1350kg
078382	84	15	9	36	25	850kg
078383	115	18	14	48	28	1350kg
078384	151	26	17	53	42	1700kg
078385	118	14	9	38	22	850kg

Zinc Steel Mooring Pins with Ring  
**Item Code 072690** L=285mm, Ø12mm  
**Item Code 072691** L=315mm, Ø15mm  
**Item Code 072692** L=350mm, Ø20mm

**Mooring Pin**



**Item Code 048501** Zinc Steel Mooring Pin Mooring Pin  
 With ring. T-Shape, L= 500mm

**Item Code 048503** Length = 490mm,  
 Spiral ø75mm, Rod ø12mm  
 Spiral length 420mm.

**Item Code 269045** Removable stainless steel Mooring hook  
 CITO S.S. 316



**S.S. Mooring hook CITO**



**Item Code 059080** Yellow Size 1. Ø350 x 400mm, 1 eye  
**Item Code 059085** Yellow Size 2. Ø350 x 460mm, 2 eyes  
**Item Code 059081** Orange Size 1. Ø350 x 400mm, 1 eye  
**Item Code 059086** Orange Size 2. Ø350 x 460mm, 2 eyes

**Anchor (Marker) Buoys**



**Item Code 059060** Yellow Size 1. Ø150 x 200mm  
**Item Code 059065** Yellow Size 2. Ø210 x 280mm  
**Item Code 059070** Yellow Size 3. Ø260 x 360mm  
**Item Code 059062** Orange Size 1. Ø150 x 200mm  
**Item Code 059068** Orange Size 2. Ø210 x 280mm  
**Item Code 059072** Orange Size 3. Ø260 x 360mm

**Marker Floats**



## 16-Plait Mooring Ropes Handmade T16 + Splice

Mooring Ropes in PES HT (high strength) sealed according to the American system which allows maintaining unaltered the ultimate strength of the rope.

### Technical Specifications

- Double braid manufacturing:
- Core of High Tenacity Polyester with 12 Spindle.
- Covering of PES HT 16 Spindle.

### Shock Absorption:

- 12% at 1/3 ultimate strength (recommended working load)
- 23% to breaking point



Black Item Code	Dark Blue Item Code	White Item Code	Ø mm	Length m	Ultimate Strength kg
020508	020608	020708	8	6.5	1870
020510	020610	020710	10	6.5	2240
020512	020612	020712	12	10	3410
020514	020614	020714	14	12	4350
020516	020616		16	14	4900
020518	020618		18	15	5100

## 16-Plait Fender Ropes Handmade T16 + Splice

Black Item Code	Dark Blue Item Code	Ø mm	Length m
020806	020906	6	2
020808	020908	8	2
020810	020910	10	3
020812	020912	12	3

2 Piece packing





**Leaded Anchor Rope**

Braided polyester anchor rope with leaded part. With stainless steel thimble and pressed sleeve.  
Kink-free, pre-stretched and extremely UV-resistant.  
Supplied on reel.

**Leaded Anchor Rope**



Dark Blue Item Code	Diam.	Reel	Leaded Part	Weight	Breaking Load
61030005	10mm	30m	10m	3.9kg	800kg
61235005	12mm	35m	12m	5.6kg	1150kg
61440005	14mm	40m	15m	8.7kg	1650kg
61650005	16mm	50m	20m	13.6kg	2100kg

**Anchor Rope**

Braided polyester anchor rope with thimble and sewn splice

**Anchor Rope**



White Item Code	Diam.	Length	Breaking Load
60830000	8mm	30m	800kg
61030000	10mm	30m	1200kg
61230000	12mm	30m	1900kg
61430000	14mm	30m	2500kg

**Mooring Rope**

3-Strand twisted polypropylene rope with eye splice

**Mooring Rope**

Black Item Code	Dark Blue Item Code	Diam.	Length
60080451	60080452	8mm	4.5m
61004501	61004502	10mm	4.5m
61206501	61206502	12mm	6.5m
61410001	61410002	14mm	10m

**Fender Rope**

3-Strand twisted polypropylene rope with eye splice

**Fender Rope**

Black Item Code	Dark Blue Item Code	Diam.	Length
60080201	60080202	8mm	2m

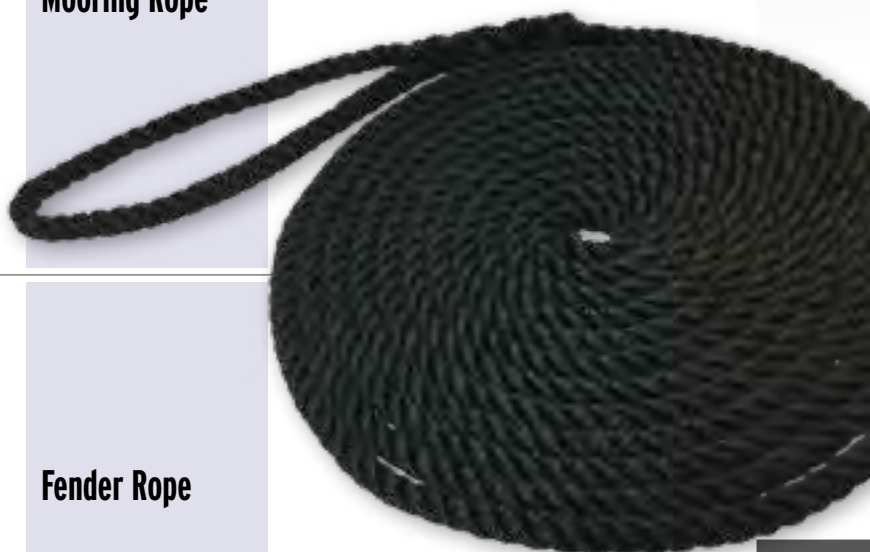

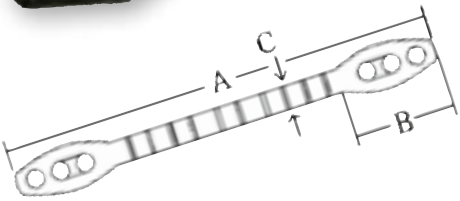

**Mooring Rubber**

Item Code	A mm	B mm	C mm	Rope Ø
078770	430	81	25	6~12mm
078771	490	112	28	14~18mm



**Stainless Steel Mooring Spring**

Strong and durable stainless steel spring with plastic anti-squeak inserts

Item Code	Ø	L	Boat max.	kg
024250	5mm	300mm	6m	1000
024251	6mm	300mm	8m	2400
024252	7mm	400mm	10m	4000
024253	9mm	470mm	12m	8000
024254	11mm	470mm	14-15m	13000

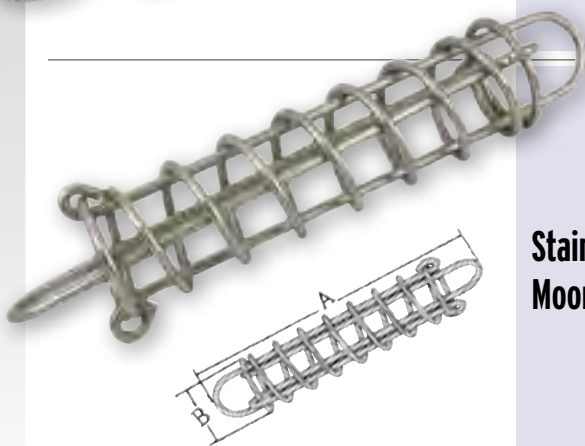

**Stainless Steel Mooring Spring**

*stainless steel*  
**316**

Item Code	A mm	B mm	Wire
078765	260	50	5mm
078766	325	60	5mm
078767	380	62	6mm

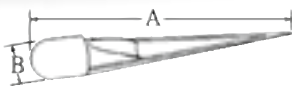

**Marline Spike Stainless Steel**

Item Code	A mm	B mm	Point mm
078875	174	23	1
078876	283	31	1.5
078877	386	45	2.0



**Net for Bow Rail**

Made of Polyester Fibre. Size of Meshes 25mm. The length shown in this catalogue is in relation to a height of about 200mm. The net can be extended to a height of 600mm while consequently the length will be reduced.

Item Code Z000080	Roll 30m
Item Code Z0000250	Roll 100m

## 3-Strand Twisted 100% Polyester - HT



3-Strand Twisted 100% Polyester. Soft, very strong, very high wear resistance. Permanently flexible. Easy to splice. Perfectly suitable as mooring rope, towing rope, or anchor rope.

### Description:

- 3-Strand Twisted
- 100% Polyester HT

### Shock Absorption:

- 15% at 1/3 of Breaking Load
- 25% at 1/1 of Breaking Load

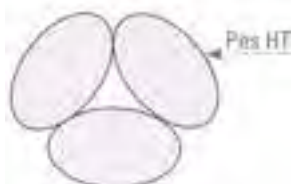

### Sinking line



Black Item Code	Dark Blue Item Code	White (blue tracer) Item Code	Diameter	Reel	Breaking Load
AL0108/ZL	AL0108/B	AL0108/L	8mm	200m	1400kg
AL0110/ZL	AL0110/B	AL0110/L	10mm	200m	2000kg
AL0112/ZL	AL0112/B	AL0112/L	12mm	200m	2600kg
AL0114/ZL	AL0114/B	AL0114/L	14mm	170m	3600kg
AL0116/ZL	AL0116/B	AL0116/L	16mm	140m	5000kg
AL0112/ZL-eco	-	AL0112/L-eco	12mm	200m	2500kg

## 3-Strand twisted Manilla 100%



3-Strand Twisted Manilla Polypropylene. Soft, very strong, very high wear resistance. Permanently flexible. Easy to splice. Perfectly suitable as mooring rope, towing rope, anchor rope et cetera.

### Description:

- 3-Strand Twisted
- 100% Polypropylene

### Shock Absorption:

- 16% at 1/3 of Breaking Load
- 28% at 1/1 of Breaking Load



### Floating line

Manilla Item Code	Diameter	Reel	Breaking Load
AL0806	6mm	220m	550kg
AL0808	8mm	220m	960kg
AL0810	10mm	220m	1420kg
AL0812	12mm	220m	2000kg
AL0814	14mm	220m	2800kg
AL0816	16mm	220m	3500kg
AL0818	18mm	220m	4400kg

# 16-strand Double Braided Mooring Rope T16HT



16-strand polyester rope of high quality thanks to the double braid manufacturing . This allows extremely rapid splice. This rope offers minimal water absorption, is extremely UV-resistant and very long wearing. Most suitable for mooring or anchor rope.

**Description:**

- Double braid manufacturing:
- Core of High Tenacity Polyester with HT 12 Spindle
- Cover of PES HT 16 Spindle

**Shock Absorption:**

- 12% at 1/3 of breaking load
- 23% at 1/1 of breaking load

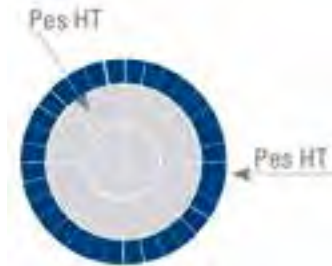

**Sinking line**

Black Item Code	Dark Blue Item Code	Grey Item Code	White (black tracer thread) Item Code	Diameter	Reel	Breaking Load
AL1608/Z	AL1608/B	AL1608/G	AL1608/W	8mm	200m	1600kg
AL1610/Z	AL1610/B	AL1610/G	AL1610/W	10mm	200m	2500kg
AL1612/Z	AL1612/B	AL1612/G	AL1612/W	12mm	200m	2900kg
AL1614/Z	AL1614/B	AL1614/G	AL1614/W	14mm	150m	3700kg
AL1616/Z	AL1616/B	AL1616/G	AL1616/W	16mm	100m	4900kg
AL1618/Z	AL1618/B	AL1618/G	AL1618/W	18mm	100m	5300kg



## Braided Polyester Sheet & Halyard Line „Easy“

Universal braid in Polyester high tenacity made with " light system technology ". Unlike to other standard multiuse braids , this is made in Polyester high tenacity , with a special light core that permit to maintain a very flexible and soft line .



**Sinking line**

White (blue tracer thread) Item Code	Diameter	Reel	Breaking Load
AL1706	6mm	200m	660kg
AL1708	8mm	200m	1050kg
AL1710	10mm	200m	1350kg
AL1712	12mm	200m	1780kg
AL1714	14mm	200m	2250kg
AL1716	16mm	200m	2800kg

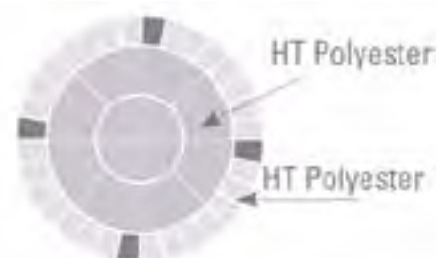

## Double Braided Sheet in White with tracer thread - HT4



Universal Sheet- and Trim line for average load. Double braided 100% polyester.

### Description:

- Core material 100% in PES HT
- Cover material 100% PES HT

### Elongation:

- 7% at 1/3 of breaking load
- 13% at 1/1 of breaking load

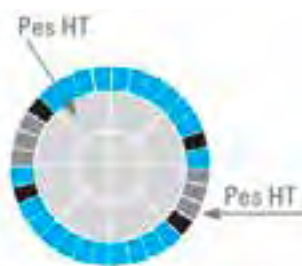

White red/black tracer thread Item Code	White green/black tracer thread Item Code	White blue/black tracer thread Item Code	White yellow/black tracer thread Item Code	Diameter	Reel	Breaking Load
AL1806/RO	AL1806/GR	AL1806/BL	AL1806/GE	6mm	200m	1100kg
AL1808/RO	AL1808/GR	AL1808/BL	AL1808/GE	8mm	200m	1650kg
AL1810/RO	AL1810/GR	AL1810/BL	AL1810/GE	10mm	200m	2700kg
AL1812/RO	AL1812/GR	AL1812/BL	AL1812/GE	12mm	200m	3200kg

## Double Braided Sheet in Full Color - HT4

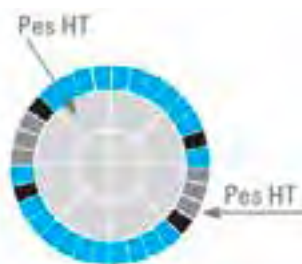

Red, grey tracer thread Item Code	Blue, grey tracer thread Item Code	Green, grey tracer thread Item Code	Yellow, grey tracer thread Item Code	Diameter	Reel	Breaking Load
AL1906/RO	AL1906/BL	AL1906/GR	AL1906/GE	6mm	200m	1100kg
AL1908/RO	AL1908/BL	AL1908/GR	AL1908/GE	8mm	200m	1650kg
AL1910/RO	AL1910/BL	AL1910/GR	AL1910/GE	10mm	200m	2700kg
AL1912/RO	AL1912/BL	AL1912/GR	AL1912/GE	12mm	200m	3200kg

## Double Braided Sheet in Mixed Colors - HT4

Mix grey/red Item Code	Mix gray/blue Item Code	Mix gray/black Item Code	Diameter	Reel	Breaking Load
AL2006/GR	AL2006/GB	AL2006/GZ	6mm	200m	800kg
AL2008/GR	AL2008/GB	AL2008/GZ	8mm	200m	1600kg
AL2010/GR	AL2010/GB	AL2010/GZ	10mm	200m	2500kg
AL2012/GR	AL2012/GB	AL2012/GZ	12mm	200m	3500kg
AL2014/GR	AL2014/GB	AL2014/GZ	14mm	150m	4500kg

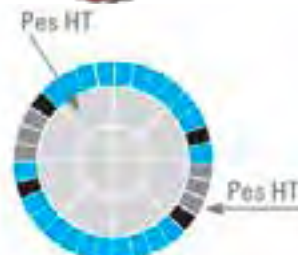

# Double braided sheet - HT13



High quality strong double braided 100% polyester sheet- & trim line and halyard. Very high wear resistant, kink free and easy to splice.

**Description:**

**Sinking line**

- Core Material 100% PES HT
- Cover Material 100% PES HT

**Elongation:**

- 6% at 1/3 of breaking load
- 12% at 1/1 of breaking load

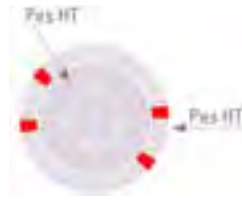

White, red tracer thread <b>Item Code</b>	White, green tracer thread <b>Item Code</b>	White, blue tracer thread <b>Item Code</b>	White, black tracer thread <b>Item Code</b>	Diameter	Reel	Breaking Load
<b>AL2106/R</b>	<b>AL2106/G</b>	<b>AL2106/B</b>	<b>AL2106/Z</b>	6mm	200m	800kg
<b>AL2108/R</b>	<b>AL2108/G</b>	<b>AL2108/B</b>	<b>AL2108/Z</b>	8mm	200m	1600kg
<b>AL2110/R</b>	<b>AL2110/G</b>	<b>AL2110/B</b>	<b>AL2110/Z</b>	10mm	200m	2500kg
<b>AL2112/R</b>	<b>AL2112/G</b>	<b>AL2112/B</b>	<b>AL2112/Z</b>	12mm	200m	3500kg
<b>AL2114/R</b>	<b>AL2114/G</b>	<b>AL2114/B</b>	<b>AL2114/Z</b>	14mm	170m	4500kg



# Braided Polyester (PA) HT-12

Indispensable as flags line, string, whipping yarn et cetera

**Description:**

Core material 100% of linear Polyester HT  
Cover material 100% Polyester HT



White <b>Item Code</b>	Black <b>Item Code</b>	Diameter	Reel	Breaking Load
<b>AL2201</b>	<b>AL2201/Z</b>	1mm	200m	60kg
<b>AL2202</b>	<b>AL2202/Z</b>	2mm	200m	100kg
<b>AL2203</b>	<b>AL2203/Z</b>	3mm	200m	300kg
<b>AL2204</b>	<b>AL2204/Z</b>	4mm	200m	500kg
<b>AL2205</b>	<b>AL2205/Z</b>	5mm	200m	600kg
<b>AL2206</b>	<b>AL2206/Z</b>	6mm	200m	700kg



# Shock Cord

High Quality Multifilament Shock Cord with Polyester Cover

White Blue tracer thread <b>Item Code</b>	Yellow <b>Item Code</b>	Red <b>Item Code</b>	Blue <b>Item Code</b>	Black <b>Item Code</b>	Diameter	Reel
<b>AL1004/T</b>	<b>AL1004/G</b>	<b>AL1004/R</b>	<b>AL1004/B</b>	<b>AL1004/Z</b>	4mm	100m
<b>AL1006/T</b>	<b>AL1006/G</b>	<b>AL1006/R</b>	<b>AL1006/B</b>	<b>AL1006/Z</b>	6mm	100m
<b>AL1008/T</b>	<b>AL1008/G</b>	<b>AL1008/R</b>	<b>AL1008/B</b>	<b>AL1008/Z</b>	8mm	100m
<b>AL1010/T</b>	<b>AL1010/G</b>	<b>AL1010/R</b>	<b>AL1010/B</b>	<b>AL1010/Z</b>	10mm	100m

**Item Code 05045** 12V-20A

**Item Code 05046** 24V-10A

1-Tone, high quality chromed brass horn Ø 200 mm with new type support. Italian design.

Complete with compressor and mounting kit.

Approved by: RINA, LLOYD'S REGISTER MCA, BUREAU VERITAS and NMMA.

According to international regulations COLREG 1972 IMO Klasse IV.

123dB (1/3 oct.), 630 Hz. L=449mm.

For vessels between 12m and 20m in length.

**Boat Horn**



**Item Code 05052**

1-Tone, "Duck" horn, electro-magnetic 12V-5A

Horn, support and membrane all off stainless steel.

Electric cable integrated. 114dB(A), 570Hz, L=250mm

**Boat Horn**



**Item Code 05062** 12V-16A

**Item Code 05063** 24V-8A

1-Tone, white plastic (ABS) horn with compressor

116dB(A), 420Hz, L=250mm

**Boat Horn**



**Item Code 05082** Electronic Whistle with loudspeaker, 12V-3A.

**Item Code 05084** Electronic Whistle with loudspeaker, 24V-1,5A.

Approved electronic whistle complete with loudspeaker, built in membrane control panel and electronic controller.

New ultrasonic heating system for improved acoustic membrane performance.

Meets COLREG 1972 IMO class IV international regulations with RINA, LLOYD'S REGISTER MCA, BUREAU VERITAS, NMMA and BSH homologations. Including mounting kit.

For vessels between 12m and 20m in length.

12V-3A, 122dB (1/3 oct.), 675Hz. Dims. 249x237mm.

Suitable for one loudspeaker only.

**Electronic Whistle with Loudspeaker**



**Item Code 05080**

Waterproof (IP67) loudspeaker with stainless steel bracket.

Suitable as speaker for radio, VHF, stereo hailers and fog horns.

8 Ohm/20W. Dims. 154x121x132mm (LxHxW),

**Loudspeaker**





**Item Code P0215017** 1-Tone Horn, chromed plastic with stainless steel base and housing, 12V-5A, 105dB(A), 610Hz, L=229mm

**Item Code P0215018** 1-Tone Horn, chromed plastic with stainless steel base and housing, 12V-5A, 105dB(A), 550Hz, L=292mm

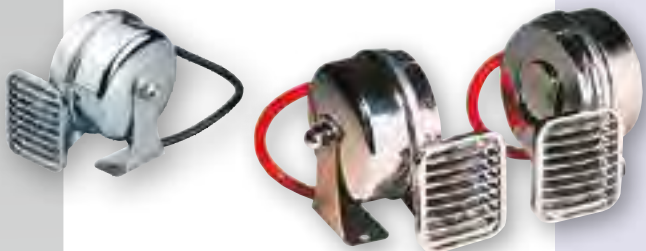

**Item Code 05010** 1-Tone Horn, stainless steel + ABS, 12V-5A, 108dB(A), 410Hz, 105x100x105mm

**Item Code 05011** Like 05010 but 490 Hz.

**Item Code 05012** 2-Tone Horn, stainless steel + ABS, 12 V-10 A, 110dB(A), 410/490 Hz. 105x100x105 mm (x2)



**Item Code 05112** 1-Tone Horn, chromed plastic, with compressor 12V-18A, 108dB(A), 326Hz, L=390mm

## Boat Horns



**Item Code 05025** Single Tone Horn, stainless steel 12V-5A, 112dB(A), 370Hz, L=400mm

**Item Code 05024** Like 05025 but 320 Hz

**Item Code 05022** 2- Tone Horn, stainless steel 12V-10A, 115dB(A), 320/370Hz, L=400/470mm, Combination **Item Code 05024+05025**



**Item Code 05102** 12V-18A

**Item Code 05103** 24V-9A

Single Tone Horn, stainless steel , with compressor, 111dB(A), 228Hz, L=500mm



**Item Code 078150** 12V

**Item Code 078155** 24V

Single Tone Horn, stainless steel, L=400 mm, D=102 mm, H=127mm, 115 dB(a) ± 5, 380 Hz ± 15

*stainless steel*  
**316**



**Item Code 078151** 12V

**Item Code 078156** 24V

2-Tone Horn, stainless steel, L=470mm, D=102 mm, H=127mm, 105 dB(a) ± 5, 400 Hz & 380 Hz ± 15



**Item Code 000500**

Chromed Brass Horn with plastic Cover  
Single Tone, 12V - 4.5A,  
110dB (A), 420Hz Dims. 100 x 155 x 70mm

**Electromagnetic Boat Horn**



**Item Code 05042**

Built-in Horn with white plastic grill and Stainless Steel Mounting Bracket. Single Tone, 12V, Dims. 140 x 110 x 80mm

**Electromagnetic Boat Horn**



**Item Code 05043**

Built-in Horn with Chromed plastic grill and Stainless Steel Mounting Bracket. Single Tone, 12V, Dims. 140 x 110 x 80mm

New gashorn with inflammable HFO 1234ZE gas.  
Meets European Norm N517/2014

**Gashorn**



**Item Code 05305** Gashorn complete with aerosol

**Item Code 05309** Extra aerosol

**Item Code L0032042** Stainless steel horn, L=178mm

**Fog-Horn**

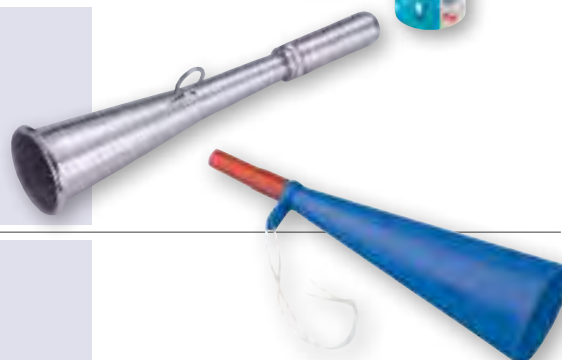

**Item Code L0030200** Plastic Horn, blue/orange

**Fog-Horn**

Item Code	Model	A mm	B mm	C mm	Volt
078660	Single	61	50	82	12V 2A
078661	Twin	220	50	82	12V 4A

**Mini Electromagnetic Boat Horns Stainless Steel**



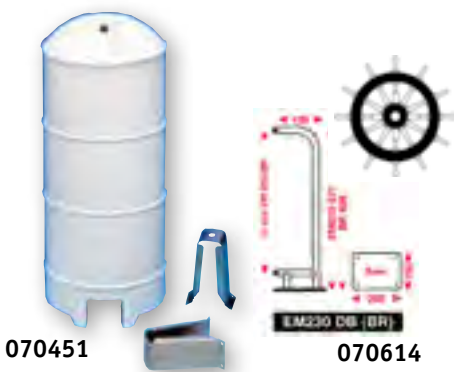

070451

070614

**ECHOMAX EM230 BR**

Best performing passive Radar Reflector for sailing yachts, RIB's and motor boats. Fits mast brackets of Firdell Blipper 210-7. Deck or mast Mount or with mast halyard. Peak @± 3°-24m². Polyethylene housing. Other colors available. Dims.: H=610mm, D=245mm. Weight 2,5kg  
**Item Code 070451** Echomax EM230 BR, cpl./w. mast brackets (070615)

**Item Code 070614** Deck bracket EM230 (BR) DB



070411

070612

070615

**ECHOMAX EM230 MIDI + MIDI BASEMOUNT**

Smallest passive Radar Reflector of the 230-series for sailing yachts, RIB's and motor cruisers. Peak @± 3°-20m². Polyethylene housing. Dims.: H=450mm, D=245mm. Weight 1,9kg

**Item Code 070411** Echomax EM230 Midi, cpl./w. mast brackets (070615)

**Item Code 070612** Deck bracket EM230M DB

**ECHOMAX EM230 MIDI BASEMOUNT** As EM230 MIDI, but base mount for radar bracket or roof. Peak @±3°-20m².

Dims.: H=428mm, D=245mm, Dbase=138mm. Weight 2,3kg

**Item Code. 070421** (not shown)



070401

**ECHOMAX EM180**

The ideal, passive Radar Reflector for small boats.

Deck or mast Mount or with mast halyard.

Peak @± 3°-8,1m². Polyethylene housing.

Dims.: H=470mm, D=197mm. Weight 1,4kg

**Item Code 070401** EM180 cpl./w. mast brackets (070605)



**ECHOMAX EM230i Inflatable**

**ECHOMAX 230i – Inflatable Radar Reflector**

Dupont® metalized, lacquered and spunbonded fabric array with PVC case; folds down neatly to pocket size and is an ideal addition to the grab bag for emergency use.

QinetiQ recorded an astonishing 20m² peak exceeding the RORC requirements by nearly two fold.

Can be mounted from halyard. Optional three piece glass fibre rod kit for dinghy or liferaft use.

@+/-3°-20m² peak. Exceeds 10m² WCC : IASF : ORC & RORC - requirement. Dims.: H = 750mm, D = 300mm. Weight 0,413kg

**Item Code 070455** ECHOMAX 230i Inflatable

**Item Code 070655** 3-Deluge montageset

**ECHOMAX Active X-Band & XS-Dual Band Radar Target Enhancer**

These Active-X & XS-Band Radar Target Enhancer (RTE) receive a signal from transmitting radar, amplify and return a stronger signal. This increases the likelihood of detection of small vessels with no radar fitted.

**Specificaties:**

**ACTIVE X Band**

• Frequency: X-Band 9.3–9.5GHz

- Position accuracy: < 1m
- Dims. antenna: L=478mm, ø40mm
- Consumption stand by: <15mA
- Consumption transmitting: X-Band 190mA
- Dims. Control panel: 92x51x38

**ACTIVE XS Dual Band**

- Frequency: X-Band 9.3–9.5GHz
- Frequency: S-Band 2.9–3.1GHz
- Position accuracy: < 1m
- Dims. Antenna: L=685mm, ø40mm
- Consumption stand by: <23mA

Exceeds new ISO 8729-2, 07-2009 performance requirements by far.

**Active X:**

(ISO Standard 7,5m2)

- 0°: • 111,36m²
- ±10°: • 78,96m²
- ±20°: • 20,80m²

**Active XS/X Band:**

(ISO Standard 7,5m2)

- 118,33m²
- 65,07m²
- 19,49m²

**Active XS/S Band:**

(ISO Standard 0,5m2)

- 15,75m²
- 16,20m²
- 13,40m²

**ISO Norm @ 0° Heel:**

7,5m2 X-Band/0,5m²S-Band

**Unique Quadruple Alarm Facility:**

- Green LED illuminates when being painted by X-Band radar (X & XS)
- Yellow LED illuminates when being painted by S-Band radar (XS)
- Switchable buzzer goes when being painted by radar (X & XS)
- Volt free relay contact for switching up to 8A horns, deck lights etcetera (X & XS)

**Code 070501** ACTIVE X-Band with standard control panel (without base or bracket)

**Code 070503** ACTIVE XS Dual-Band with standard control panel (without base or bracket)

**Code 070508** ACTIVE XS Dual-Band with watertight control panel (without base or bracket)

**Code 070509** Waterproof (IP68) control panel for ACTIVE X & XS

**Code 078550** Stainless steel mast base

**Code 070505** Stainless steel offset mast bracket

**Code 070506** Stainless steel "Ocean" offset mast bracket

Scope of delivery: Antenna, 24m cable und and control panel



070505

070506

078550

070509

070503

070501

**Item Code 008005** Approved black nylon 2-piece anchor ball.  
Dims.: Ø350mm. Weight 500 gr.

**Black Anchor Ball  
& Black Cone**



**Item Code 008004** Approved black nylon 2-piece cone.  
For sailing boats with auxiliary engine.  
Height: 470mm, weight 360 gr.

**Item Code L3400041** Radar reflector, foldable, aluminum.  
Size 30cm (Standard). Weight 470 gr. Array: 8m2

**Folding  
Radar Reflector**



**Item Code L3400043** Radar reflector, foldable, aluminum.  
Size 40cm (R.O.R.C.). Weight 900 gr. Array: 10m2

**Item Code L3400046** Radar reflector, foldable, aluminum.  
Size 46cm (I.O.R.). Weight 1100 gr. Array: 12m2

Tubular reflector. L=585mm, Ø50mm. Array 2m2.  
Weight 380 gr., range: 2,5 nautical miles.

**Tubular  
Radar Reflector**

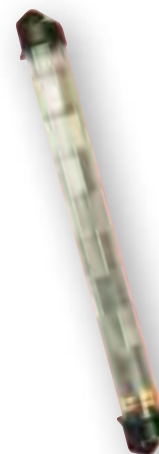

**Item Code 072500** with eyes for hoisting

**Item Code 072501** bracket mount

**Item Code L3401012** Radarreflector, foldable, aluminum.  
Dims. 30cm. Weight 770 gr. Array: 12,5m2. Range 12 nautical miles.

**Folding  
Radar Reflector  
& Brackets**



**Item Code L3403150** Reflector holder pole for life rafts. 150cm.  
Type A

**Item Code L3402012** Sailboat version fixation.  
Type B

**Item Code L3403012** Motorboat bracket.  
Type C

**Item Code L3404012** Clamp for Ø22-28mm tube.  
Type D

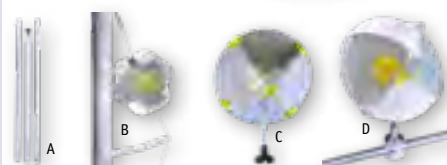

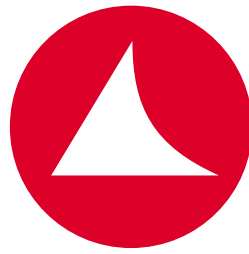

**allpa**  
marine equipment



**Dutch LIFE-SAVING**



**allpa Dutch life-saving soft (A)**

Code	Size	Weight	Chest size	Buoyancy
131104	XXXS	4/15 kg	50/60 cm	>35 N
131115	XXS	15/30 kg	60/70 cm	>40 N
131130	XS	30/40 kg	70/80 cm	>50 N
131140	S	40/50 kg	80/90 cm	>60 N
131150	M	50/70 kg	90/100 cm	>80 N
131170	L	70/80 kg	100/110 cm	>100 N
131180	XL	80/90 kg	110/120 cm	>100 N
131190	XXL	>90 kg	120/130 cm	>100 N

Particularly comfortable life jacket. Solas reflective stripes, handles, cross strap and signal whistle.  
Polyester cover, polyethylene filling material.  
**Conform CE ISO 12402-4**

**allpa Norman (B)**

Code	Size	Buoyancy
031701	ONE SIZE	100 N
<b>Conform CE ISO 12402-4</b>		

**allpa safety bag (C)**

Code	Size	Buoyancy
031702	ONE SIZE	100 N
<b>Conform CE ISO 12402-4</b>		
Bag included 4x 031702		



# Dutch LIFE-SAVING



A

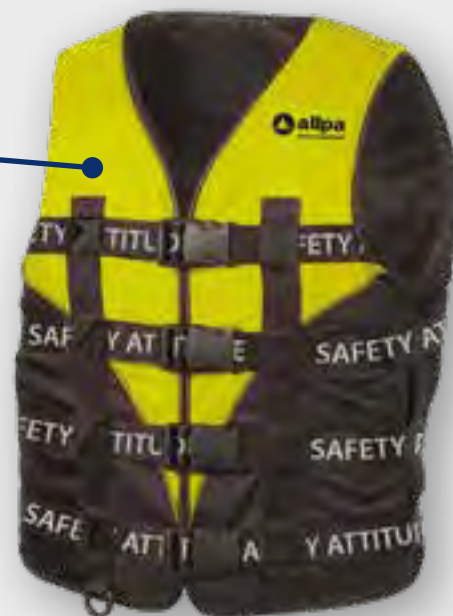

B



C



**allpa Dutch life-saving storm (A)**

Code	Size	Weight	Chest size	Buoyancy
031660	S	25/40 kg	65/80 cm	>40 N
031661	M	40/70 kg	80/100 cm	>45 N
031662	L	70/80 kg	100/110 cm	>50 N

Lightweight all-round water sports vest.  
Adjustable belt with buckle.  
Conform CE ISO 12402-5

**allpa Dutch life-saving racing (B)**

Code	Size	Weight	Chest size	Buoyancy
031671	M	40/70 kg	80/100 cm	>45 N
031672	L	70/80 kg	100/110 cm	>50 N
031673	XL	>80 kg	110/125 cm	>50 N

Racing water sports vest with high freedom of movement.  
With 4 adjustable belts.  
Conform CE ISO 12402-5

**allpa Dutch life-saving sport (C)**

Code	Size	Weight	Chest size	Buoyancy
031665	S	25/40 kg	65/80 cm	>40 N
031666	M	40/70 kg	80/100 cm	>45 N
031667	L	70/80 kg	100/110 cm	>50 N
031668	XL	>80 kg	110/125 cm	>50 N

Comfortable water sports vest with high freedom of movement. With 3 adjustable belts.  
Conform CE ISO 12402-5

# Dutch LIFE-SAVING

# NEOPREEN SERIES

**NEW**



## First automatic neoprene life jacket!

- Extremely light < 1kg!
- The machine is high and slanted posted what the portability especially in women extreme improved.



### allpa Dutch life-saving impact (A)

Code	Size	Weight	Chest size	Buoyancy
031656	JN/S	40/70 kg	86/100 cm	>45 N
031657	M/L	70/80 kg	100/110 cm	>50 N
031658	XL/XXL	>80 kg	110/125 cm	>50 N

Material CR neoprene with PVC foam cluster. Extremely comfortable water sports vest with maximum protection.  
Conform CE ISO 12402-5

### allpa Dutch life-saving neopreen 180 N (B)

Code	Size	Weight	Chest size	Buoyancy
031236	UNISEX	>40 kg	86/124 cm	180 N

Adjustable safety harness certified according to ISO 12401. Adjustable and detachable crotch strap. Sprayhood according to ISO rules. Solas reflective stripes and ISO certified whistle  
Conform CE ISO 12402-3;ISO 12401

# Dutch LIFE-SAVING

# LAKE SERIES

**NEW**

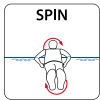

### allpa Dutch life-saving antares 150 & 275 N (A)

Code	Size	Weight	Buoyancy
031203/A	ADULT	>40 kg	160 N
031219/A	ADULT	>40 kg	300 N

Adjustable and detachable crotch strap. Solas reflective stripes and ISO certified whistle.  
Conform CE ISO 12402-3;ISO 12401-2

### allpa Dutch life-saving skipper 150 N (B)

Code	Size	Weight	Buoyancy
031229	ADULT	>40 kg	150 N

Adjustable and detachable crotch strap. Solas reflective stripes and ISO certified whistle.  
Conform CE ISO 12402-3

# Dutch LIFE-SAVING



# OCEAN SERIES

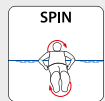

**NEW**



allpa Dutch life-saving ocean series 160 & 290 N

Code	Size	Weight	Chest size	Buoyancy	Conform
031238	ADULT	>50 kg	86/124 cm	160 N	ISO12402-3;ISO 12401
031239	ADULT	>50 kg	86/124 cm	290 N	ISO12402-2;ISO 12401

Harness with new locking system, certified according to ISO 12401 and D-ring.  
Includes spray hood, automatic emergency lighting, crotch strap and floating blade.

# Dutch LIFE-SAVING



**NEW**



**NEW**

**allpa Dutch life-saving dog & cat vest**

Code	Size	Weight
031636	S	<10 kg
031637	M	10-20 kg
031638	L	>20 kg

Equipped with sturdy handles. Easy to put on, waistbands with clip closure.

**allpa Dutch life-saving water sports helmet**

Code	Size	Colour
031687	S	Black
031688	M	Black
031689	L	Black



# Dutch LIFE-SAVING



031020



031021

**Replacement Kits Halkey Roberts (HK)**

Code	Model	Size	
031020	V9000	33 g	CO2 cylinder, clip and HR melting tablet
031021	V9000	60 g	CO2 cylinder, clip and HR melting tablet



031022

**Replacement Kits United Moulders (UML)**

Code	Model	Size	
031022	MK5	33 g	CO2 cylinder, clip and UML melting tablet
031023	MK5	60 g	CO2 cylinder, clip and UML melting tablet



031023

Oil-resistant polystyrene core Covered by entirely welded PVC.  
Color white with red bands. Complete with line.  
Buoyancy-Test: 18kg - 180Nm

**Item Code N1455030** 550 x 300mm  
**Item Code N1465040** 650 x 400mm

### Annular Lifebuoy



Meets SOLAS 74(83) Res. IMO A689(17).  
With 4 retro-reflective tapes. Made of blow pressed polyethylene Filled with expanded polyurethane.  
Color orange. Complete with line.  
Outer Ø75mm. Inner Ø45mm. Weight: 2,5kg

**Item Code N1475045**

### Annular Lifebuoy "Taurus"



Made of soft cellular foam with  
PVC coated nylon zipped cover.

**Item Code N1555001** Orange

### Horseshoe Lifebuoy "Commodore"



Complete with approved rescue light and bracket

**Item Code N1515377**

### Horseshoe Lifebuoy "Ares"



Kit consists of:

- Horseshoe lifebuoy
- Rescue light
- 30 m rescue rope
- Watertight case with boat hooking system

**Item Code N1660004**

### Safety Kit "Polaris"





### Lifebuoy Holder

**Item Code 048047**

Simple Stainless Steel Holder  
Railing (Ø25mm) or Bulkhead mount

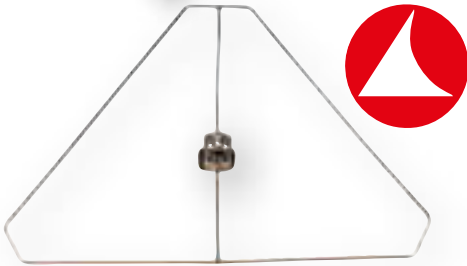

### Holder for Horseshoe Lifebuoy

**Item Code N1700545**

Stainless steel holder for horseshoe lifebuoy



### Life Buoy Holders

**Item Code N1725320**

Stainless steel Railing (Ø25mm) or  
Bulkhead mount with shock cord and nylon snap hook

**Item Code N1725520**

Same as above but with nylon holder  
for Lifebuoy light.



### Floating Rope for Annular Lifebuoy

**Item Code 001100**

Floating braided rope with nylon snap hook. L = 30m, orange.

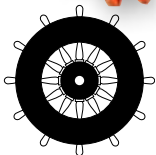

wheelmark



### Lifebuoy Lights

**Item Code L1900960**

Floating Lifebuoy Light with nylon bracket (L1944035)  
Approved by EU Marine Dir.96/98EC-98/85EC.

**Item Code L1944035**

Nylon bracket for Life Buoy light  
For tube Ø22-25mm.



### Emergency Plugs

**Item Code 078790**

10 Piece Set of conical wooden plugs  
from 5 to 28mm diameter.

**Item Code T0206230**

Kit including 23m, Ø6mm polypropylene floating rope. Weight 680gr.

**Item Code T0200230** Stainless Steel bracket

**Security Line**



**Item Code T0208022**

Compact model in container with boat hooking device. Including 30m, Ø8mm floating rope. Breaking load 400kg. Dims. 400x220x120mm. CE-approval EN-89/686-EEC Chest size Ø80-120cm

**Man Overboard Rescue System**



**Item Code B1400051**

Comfort Safety harness model with vest and stainless steel buckles. Breaking load 2000kg. Chest size Ø80-120cm

**Safety Harness Comfort "Tango"**



**Item Code S1630005**

Ladder made of nylon belt with plastic steps. Supplied with nylon bag and grab loop

**Emergency Laddy**

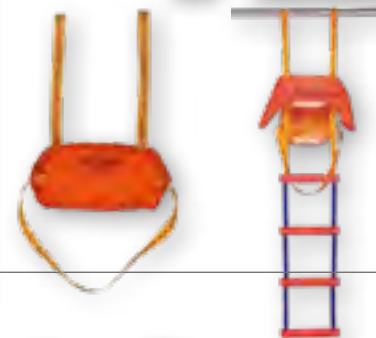

**Item Code B1480120**

Safety Harness model made of high tenacity polyester belt. With quick fastening stainless steel buckle CE-approval EN-89/686 EEC Breaking load 2000kg Chest size Ø80-120cm

**Safety Harness "Olympia"**



Life line models 2000kg with stainless steel snap hooks complying with rules 89/686 EEC - EN 1095\* Breaking load 2000kg

**Item Code B1402200** with 1 snap hook. L=200cm (\*Non-CE)

**Item Code B1420002** Model "Hercules-I" (CE-EN 1095) with 2 snap hooks. L=190cm

**Item Code B1420003** Model "Hercules-II" (CE-EN 1095) with 3 snap hooks. L=200+100cm

**Item Code B1402077** Model "Mystic-II" (CE-EN 1095) with 2 snap hooks. Elastic belt, L=100 to 190cm

**Item Code B1403077** Model "Mystic-III" (CE-EN 1095) with 3 snap hooks. Elastic belt, L=100 to 190cm + 100cm non elastic part

**Life Lines for Safety Harness**





**allpa  
Hand Bearing  
Compass  
"ORION"**

**Item Code 035200**

- 48mm, 10 Degree Direct Reading Dial
- Sapphire Jewel & Hardened Steel Pivot Dial Movement
- Floating
- Shockproof
- Color blue with light yellow, fluorescent card
- Movable Bezel with Heading Indicator



**allpa  
Deck/Binnacle  
Mount Compass  
"SCOUT"**

**Item Code 035210**

- 65mm, 5 Degree Direct Reading Dial
- Sapphire Jewel & Hardened Steel Pivot Dial Movement
- Color Black with Black Card
- Antiglare Dome



**allpa  
Bulkhead Mount  
Compass  
"ADVENTURE"**

**Item Code 035220**

- 80mm, 5 Degree Direct Reading Dial
- Sapphire Jewel & Hardened Steel Pivot Dial Movement
- Complete Internal Gimbal System
- Color Black with Black Card
- Antiglare Dome
- Standard 12V Lighting
- Standard Clinometer
- MED-Certified according directive 96/98CE-Mod.B



**allpa  
Bulkhead Mount  
Compass  
"PEGASUS"**

**Item Code 035270** allpa Bulkhead Mount Compass "Pegasus"  
**Item Code 035275** protective cover

- 100mm, 5 Degree Direct Reading Dial
- Sapphire Jewel & Hardened Steel Pivot Dial Movement
- Complete Internal Gimbal System
- Color White with Black Card
- Antiglare Dome
- Standard 12V Lighting
- Standard Clinometer



**allpa  
Flush Mount  
Compass  
"TACTICA"**

**Item Code 035280**

- 80mm, 5 Degree Flat Dial
- Sapphire Jewel & Hardened Steel Pivot Dial Movement
- Complete Internal Gimbal System
- Color Black with Tactical Card
- Antiglare Dome
- Standard Clinometer

**Item Code 035230**

- 70mm, 5 Degree Flat Dial
- Sapphire Jewel & Hardened Steel Pivot Dial Movement
- Complete Internal Gimbal System
- Color Black with Blue Card
- Standard 12V Lighting
- Antiglare Dome
- Built in Compensators
- Repairable
- MED-Certified according directive 96/98CE-Mod.B

**allpa  
Flush Mount  
Compass  
"eXtreme"**

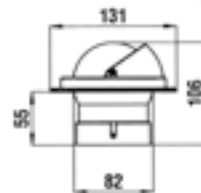
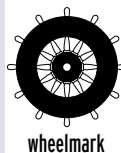

**Item Code 035240**

- 70mm, 5 Degree Flat Dial
- Sapphire Jewel & Hardened Steel Pivot Dial Movement
- Complete Internal Gimbal System
- Color Black with Blue Card
- Standard 12V Lighting
- Antiglare Dome
- Built in Compensators
- Repairable
- MED-Certified according directive 96/98CE-Mod.B

**allpa  
Bracket Mount  
Compass  
"eXtreme"**

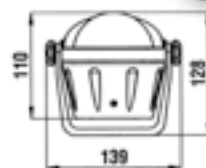
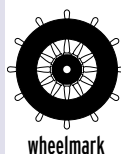

**Item Code 035260** Black with blue card

**Item Code 035265** Black with black card

- 100mm, 5 Degree Flat Dial
- Sapphire Jewel & Hardened Steel Pivot Dial Movement
- Complete Internal Gimbal System
- Standard 12-24V Lighting
- Antiglare Dome
- Built in Compensators
- Repairable
- MED-Certified according directive 96/98CE-Mod.B

**allpa  
Flush Mount  
Compass  
eXtreme"**

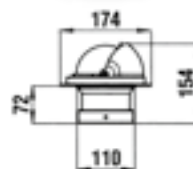

**Item Code 035250**

- 80mm, 5 Degree Flat Dial
- Sapphire Jewel & Hardened Steel Pivot Dial Movement
- Complete Internal Gimbal System
- Color Black with Blue Card
- Standard 12V Lighting
- Antiglare Dome
- Built in Compensators
- Repairable
- MED-Certified according directive 96/98CE-Mod.B

**allpa  
Flush Mount  
Compass  
"eXtreme"**

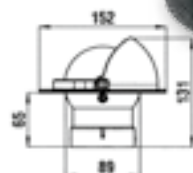
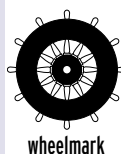



**Ritchie SportAbout**

- Item Code 067011** Hand bearing compass yellow
- Easy-to-Read 2" Direct-Reading Dial
  - Hardened Steel Pivot and Sapphire Jewel Movement
  - Built-in Roller Diaphragm for Extended Temperature Operating Range
  - International Safety Yellow
  - Silicon Impact Resistant Case with Neck Lanyard
  - QuickSight™ V-Notch and Lubber Line for Easy Heading Alignment
  - Non-Electric Chem Sticks Provide 18 hours of Night Lighting
  - Dims. 65 x 36mm (l x h)
  - Exclusive 5-Year Ritchie Warranty

New Holder for Deck Mounting Ritchie SportAbout Compasses on Small Boats

**Item Code 067015** white    **Item Code 067016** black



**Ritchie Sport**

- Item Code 067010** Model X-10M
- Easy-to-Install with Two-Sided, Self-Adhesive Mounting Pad (included)
  - Reversible Bracket Adjusts through 300°
  - 2" Direct-Reading, High-Visibility Dial
  - Hardened Steel Pivot and Sapphire Jewel Movement
  - Built-in Compensators
  - Internal Green Night Lighting (12V)
  - Exclusive 5-Year Ritchie Warranty



**Ritchie Sport Dash Mount Compasses**

**Item Code 067116** X-21 WW  
**Item Code 067117** X-21 BU

- 1-7/8" Direct-Reading Dial
- Hardened Steel Pivot and Sapphire Jewel Movement
- Exclusive Built-in Green NiteVu Lighting (12V)
- Easily Installed, Fits Standard 2-1/16" (52mm) Instrument Hole
- Adjustable 45° to Match Dash Angles
- Same Style and Dimensions as Teleflex Instruments
- Exclusive 5-Year Ritchie Warranty



**Ritchie WetNotes**

- Item Code 067210** Model W-50
- Ideal for Work or Play Outdoors...Boaters, Divers, Naturalists, Campers, Engineers
  - Size 4-1/2" x 7-1/4" (114 x 184mm)
  - Completely Waterproof, for Use Under Water
  - 45 Pages
  - Uses Regular Soft Lead Pencil (included)
  - Opens Flat for Easy Writing
  - Plastic Ring Allows Easy Removal of Pages
  - Tough International Safety Yellow Vinyl Cover

**Even Under Water !**



- Item Code 067090** Model DNP-200  
Stainless Steel
- Item Code 067091** Model DNB-200 Bl
- Item Code 067092** Model DNW-200 White

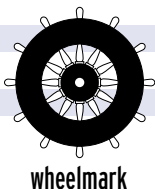

Ritchie Navigator™

### Deck/Binnacle Mounts with 4-1/2" Dials

- Ideal for both Power and Sail Boats
- Fits all popular Sailboat Steering Pedestals
- Large 5 Degree 4-1/2" PowerDamp Flat Card
- Scientifically Matched Sapphire Jewel & Hardened Steel Pivot Dial Movement
- Exclusive Built-in Green NiteVu Lighting (12V)
- Built-in Compensators
- Movable Sun Shield
- Choice of Brushed Stainless Steel or Black or White Binnacles
- 45° Lubber Lines
- Exclusive 5-Year Ritchie Warranty



067090



067091



067092



- Item Code 067093** Model FN-201 Black
- Item Code 067094** Model FNW-201 White

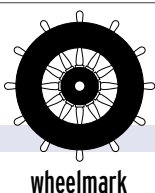

Ritchie Navigator™

### Flush Mount Compasses

- Ideal for both Power and Sail Boats
- Large 5 Degree 4-1/2" PowerDamp Flat Card
- Scientifically Matched Sapphire Jewel & Hardened Steel Pivot Dial Movement
- Exclusive Built-in Green NiteVu Lighting (12V)
- Movable Sun Shield
- 45° Lubber Lines
- Exclusive 5-Year Ritchie Warranty



067093



067094

- Item Code 067061** XP-98W Tactical Compass, white  
For sailboats up to 24'

RITCHIE TACTICIAN

### Small Sailboat Racing Compass

- High-Visibility Blue 3" Dial with extra large numerals
- Combi Dial with Tactical Quadrants show Wind Shifts and Headers
- CourseMinder™ Movable Bezel & Heading Indicator Locks-in Rhumb or Lay Lines
- 45° Lubber Lines and extra 90° Lubber Lines
- Forward Lubber Line to Steer Magnetic Courses
- 25° Heel Angle
- Easy to Install - Twist On/Off for easy Removal
- Sapphire Jewel & Hardened Steel Pivot Dial Movement
- Exclusive 5-Year Ritchie Warranty



- Item Code 067106** XP-99W Canoe Compass, white

RITCHIE KAYAKER

### Special Canoe Compass

- CourseMinder™ Movable Bezel & Heading Indicator
- Extended Temperature Operating Range
- Sapphire Jewel & Hardened Steel Pivot Dial Movement
- 3" (76mm) Combi Dial
- Exclusive 5-Year Ritchie Warranty



067030



067031

**RITCHIE EXPLORER**

**Dash Mount  
Compasses**

**Item Code 067030** V-57.2 Black

**Item Code 067031** V-57W.2 White

- 2-3/4" Direct-Reading Dial
- Adjustable 45° to Match Dash Angles
- Sapphire Jewel & Hardened Steel Pivot Dial Movement
- Built-in Compensators
- Exclusive Built-in NiteVu Lighting
- Exclusive 5-Year Ritchie Warranty
- Easily Installed, Fits 3" Instrument Hole

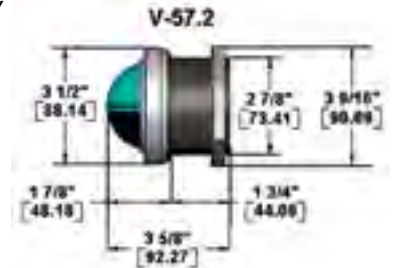

067032



067034



067033



**RITCHIE EXPLORER**

**Item Code 067032** RA-93 Ritchie Angler

**Item Code 067033** S-53 Black

**Item Code 067034** S-53G Grey

- For small Power-Boats
- 2-3/4" Direct Reading Dials
- Compact Low-Profile Design, with Push Button Removal
- Sapphire Jewel & Hardened Steel Pivot Dial Movement
- Movable Sun Shield
- Built-in Compensators
- Exclusive Built-in NiteVu Lighting
- Exclusive 5-Year Ritchie Warranty

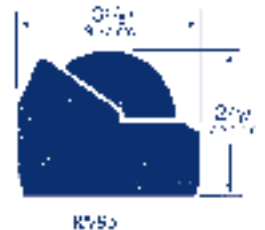

067035



067036



067037



**RITCHIE EXPLORER**

**Item Code 067035** RA-91 Ritchie Angler

**Item Code 067036** B-51 Black

**Item Code 067037** B-51G Grey

- Perfectly suitable for small Power and Sail Boats
- 2-3/4" Direct-Reading Dial
- Adjustable Bracket Mount with Thumb Screws
- Easy Removal
- Sapphire Jewel & Hardened Steel Pivot Dial Movement
- Movable Sun Shield
- Built-in Compensators
- Exclusive Built-in NiteVu Lighting
- Exclusive 5-Year Ritchie Warranty

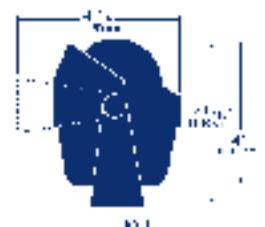

RITECHIE **EXPLORER**

**Item Code 067039** F-50 Flush Mount, Black

**Item Code 067040** F-50W Flush Mount, White

- Perfect for small Power- and Sail Boats
- 2-3/4" Easy-to-Read Direct Reading Dial
- Sapphire Jewel & Hardened Steel Pivot Dial Movement
- Movable Sun Shield
- Built-in Compensators
- Exclusive Built-in NiteVu Lighting
- Exclusive 5-Year Ritchie Warranty

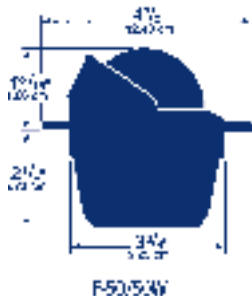

067040



067039

**Item Code 067072** HELMSMAN HV-76 Flat Card

**Item Code 067095** NAVIGATOR BN-202 Combi Dial

- For Power- and Sail Boats
- 3-3/4" Power Damp or Direct Reading Dial for Helmsman
- 4-1/2" CombiDial for Navigator
- Sapphire Jewel & Steel Hardened Pivot Dial Movement
- Built-in Compensators
- Exclusive Built-in NiteVu Lighting
- BN-202 with Built-in Clinometer
- 45° Lubber Lines
- Internal Gimbal Systems for Maximum Stability During Adverse Pitch and Roll Conditions
- Exclusive 5-Year Ritchie Warranty
- HV-76/77: Mounting Hole 127mm
- BN-202: Mounting Hole 146mm



Ritchie  
Helmsman and  
Navigator  
Bulkhead  
Mount  
Compasses

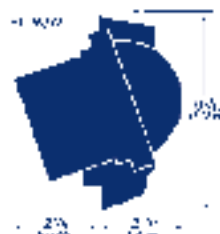

067072



067095

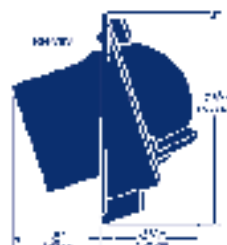

**Item Code 067085** Ritchie Venture SR-2

Bulkhead mount. For sailboats only. Suitable for boats from 16' up to 36'. Fits cutout Plastimo Contest compass. Direct Reading CombiDial 3-3/4"(94mm) with 45° lubber lines. Built-in green LED night lighting, 12 V. Compensator SR-CM2 may be purchased if needed. Clinometer 2 x 45° included but separately supplied. Max. mounting angle 40°. Mounting hole 118-122mm. Comes complete with protective cover.

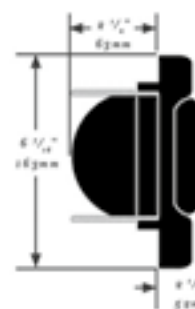

067085



067070

067071

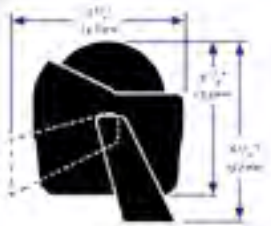

Ritchie Helmsman™

### Bracket Mount Compasses

**Item Code 067070** HB-740 Flat Card

**Item Code 067071** HB-741 Direct Read

- For Power- and Sail Boats
- 3-3/4" PowerDamp® or Combi Damp™ Dials
- Sapphire Jewel & Hardened Steel Pivot Dial Movement
- Built-in Compensators
- Exclusive Built-in NiteVu Lighting
- Movable Sun Shield
- 45° Lubber Lines
- Exclusive 5-Year Ritchie Warranty



067076/77



067078/79

Ritchie Helmsman™

### Flush Mount Compasses

**Item Code 067076** HF-742 Black, Flat Card

**Item Code 067077** HF-742W White, Flat Card

**Item Code 067078** HF-743 Black, Direct Read

**Item Code 067079** HF-743W White, Direct Read

**Item Code 067182** H-ABLK adapter flange, black\*

**Item Code 067183** H-ABHT adapter flange, white\*

\* Adapter from old (HF-73) to new (HF-743)

- For today's most Popular Size Power- and Sail Boats
- 3-3/4" PowerDamp® or CombiDamp™ Dials
- Sapphire Jewel & Hardened Steel Pivot Dial Movement
- Built-in Compensators
- Movable Sun Shield
- 45° Lubber Lines
- Exclusive 5-Year Ritchie Warranty
- Dims. Ø152mm, H =56mm, Built-in depth 63mm, Mounting Hole Ø121mm

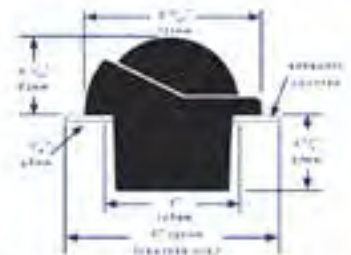

**Deck/Binnacle & Bracket Mount Compasses**

**Item Code 067050** B-80 BracketMount, Flat Card

**Item Code 067051** B-81 BracketMount, Direct Read

- For Power- and Sail Boats
- 3" PowerDamp® or CombiDamp™ Dials
- Sapphire Jewel & Hardened Steel Pivot Dial Movement
- Built-in Compensators
- Exclusive Built-in NiteVu Lighting
- Movable Sun Shield
- 45° Lubber Lines
- Exclusive 5Year Ritchie Warranty

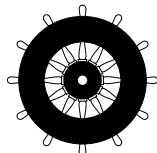

wheelmark: B-81

**Ritchie Voyager**

067050/51



**Item Code 067058** RU-90 black

- For small Sail Boats
- 3" PowerDamp® Dials
- Sapphire Jewel & Hardened Steel Pivot Dial Movement
- Built-in Compensators
- Internal Gimbal Systems for Maximum Stability During Adverse Pitch and Roll Conditions
- 45° Lubber Lines
- Movable Sun Shield
- Exclusive 5-Year Ritchie Warranty
- Mounting Hole Ø10,5mm

**Ritchie VOYAGER  
Flush Mount  
Compasses**

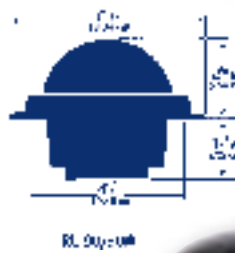

067058

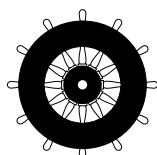

wheelmark: F-83

**Flush mount Compasses**

**Item Code 067054** Model F-82 Black, Flat Card

**Item Code 067055** Model F-82W White, Flat Card

**Item Code 067056** Model F-83 Black, Direct Read

**Item Code 067057** Model F-83W White, Direct Read

- For Power- and Sail Boats
- 3" PowerDamp® or CombiDamp™ Dials
- Sapphire Jewel & Hardened Steel Pivot Dial Movement
- Built-in Compensators
- Exclusive Built-in NiteVu Lighting
- Movable Sun Shield
- 45° Lubber Lines
- Exclusive 5-Year Ritchie Warranty
- Mounting Hole F-83: Ø10,67mm

**Ritchie Voyager**

067054/55



067056/57



**THE GLOBEMASTER**

- Absolute Top Quality!
- Over 150 Years of Personal Craftsmanship
- Choice of 2° or 5° Dials, 5" or 6" Models
- Available with Polished Stainless Steel, Black or Polished Brass Finish
- Ideal either for Power- or Sail Boats
- High Tech, Optically Clear and Scratch Resistant Polymer Dome providing a Clear and Accurate Magnification of the Dial
- 90° Lubber Line
- Extra 45° Lubber Lines for Sail Boat Executions
- Sapphire Jewel & Hardened Steel Pivot Dial Movement
- Internal Gimbal Systems for Maximum Stability during Adverse Pitch and Roll
- 12V Night Lighting on all Models (also in 24 or 32V available)
- High-Strength Glass Reinforced Polymer Bowl and Housing for 5" Models
- Brass Bowl and Housing for 6" Models
- Reliable throughout Extreme Temperature Ranges
- Built-in Compensators
- 100% Repairable
- Exclusive 5-Year Ritchie Warranty
- All Ritchie Globemaster Compasses are individually custom assembled to order Please specify when ordering:  
Dial 2 or 5° (G-2, G-2-P, G-5)  
Voltage 12, 24 or 32V  
Sail Boat Execution = "E"  
Finish: B=Black, P=Stainless Steel, X=Brass  
Delivery Time: 2-3 Weeks
- Compasses from ItemCode 067370 up to 067399 come standard with a Hood

**Traditional Binnacle & Flush Mount Compasses**



067350

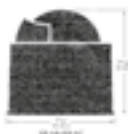

067360



067365



067371



067381



067391



067396



Item C.	Model	ø Dial	Application	Mounting	Finish
067350	SP-5B	5"	Power&Sail	Binnacle	Black
067360	SP-5C	5"	Power&Sail	Binnacle	StainlessSteel
067365	FB-500	5"	Power Boat	Flush	Black
067366	SF-500	5"	Sail Boat	Flush	Black
067367	FB-600	6"	Power Boat	Flush	Black
067368	SF-600	6"	Sail Boat	Flush	Black
067370	FD-500-B	5"	Power Boat	Flush	Black
067371	FD-500-P	5"	Power Boat	Flush	Stainless Steel
067372	FD-500-X	5"	Power Boat	Flush	Brass
067373	FD-500-EB	5"	Sail Boat	Flush	Black
067374	FD-500-EP	5"	Sail Boat	Flush	Stainless Steel
067375	FD-500-EX	5"	Sail Boat	Flush	Brass
067380	FD-600-B	6"	Power Boat	Flush	Black
067381	FD-600-P	6"	Power Boat	Flush	Stainless Steel
067382	FD-600-X	6"	Power Boat	Flush	Brass
067383	FD-600-EB	6"	Sail Boat	Flush	Black
067384	FD-600-EP	6"	Sail Boat	Flush	Stainless Steel
067385	FD-600-EX	6"	Sail Boat	Flush	Brass
067387	D-515-B	5"	Power Boat	Binnacle	Black
067388	D-515-P	5"	Power Boat	Binnacle	StainlessSteel
067389	D-515-X	5"	Power Boat	Binnacle	Brass
067390	D-515-EB	5"	Sail Boat	Binnacle	Black
067391	D-515-EP	5"	Sail Boat	Binnacle	StainlessSteel
067392	D-515-EX	5"	Sail Boat	Binnacle	Brass
067394	D-615-B	6"	Power Boat	Binnacle	Black
067395	D-615-P	6"	Power Boat	Binnacle	StainlessSteel
067396	D-615-X	6"	Power Boat	Binnacle	Brass
067397	D-615-EB	6"	Sail Boat	Binnacle	Black
067398	D-615-EP	6"	Sail Boat	Binnacle	StainlessSteel
067399	D-615-EX	6"	Sail Boat	Binnacle	Brass

<b>Item Code 067018</b>	SS-1002	black
<b>Item Code 067019</b>	SS-1002W	white
<b>Item Code 067182</b>	adapter ring	black
<b>Item Code 067183</b>	adapter ring	white

- For High Speed Boats, Offshore Racers and Multi Hull Sail Boats
- 94mm(3-3/4") Blue dial with large white numerals
- Low-viscosity –liquid for superfast response
- Sapphire Jewel & Hardened Steel Pivot Dial Movement
- Built-in Compensators
- Built-in NiteVu Lighting
- Exclusive 5-Year Ritchie Warranty
- Mounting Hole  $\varnothing$ 121mm

RITCHEY **SUPERSPORT**

### Flush Mount Compasses



067019



067018

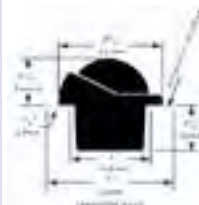

<b>Item Code 067021</b>	SS-2000	black
<b>Item Code 067024</b>	SS-2000W	white

- For High Speed Boats, Offshore Racers and Multi Hull Sail Boats
- 114mm(4-1/2") Blue dial with large white numerals
- Low-viscosity –liquid for superfast response
- Sapphire Jewel & Hardened Steel Pivot Dial Movement
- Built-in Compensators
- Built-in NiteVu Lighting
- Exclusive 5-Year Ritchie Warranty
- Mounting Hole  $\varnothing$ 130mm

RITCHEY **SUPERSPORT**

### Flush Mount Compasses



067024



067021

<b>Item Code 067022</b>	SS-5000	black
<b>Item Code 067025</b>	SS-5000W	white

- For High Speed Boats, Offshore Racers and Multi Hull Sail Boats
- 127mm (5") Blue dial with large white numerals
- Low-viscosity –liquid for superfast response
- Sapphire Jewel & Hardened Steel Pivot Dial Movement
- Built-in Compensators
- Built-in NiteVu Lighting
- Exclusive 5-Year Ritchie Warranty
- Mounting Hole  $\varnothing$ 159mm

RITCHEY **SUPERSPORT**

### Flush Mount Compasses



067025



067022

<b>Item Code 067161</b>	HC-80 Internal Cover HV-76/77 Helmsman
<b>Item Code 067162</b>	NC-20 Internal Cover BN-202 Navigator
<b>Item Code 067180</b>	N-LB Bulkhead Levelling Block 7° Teak BN-202 Navigator
<b>Item Code 067181</b>	H-LB Bulkhead Levelling Block 7° Teak HV-76/77 Helmsman
<b>Item Code 067163</b>	V-80-C Cover F-82, B-80, D-84/85 Voyager
<b>Item Code 067164</b>	V-81-C Cover RU-90 Voyager
<b>Item Code 067166</b>	H-71-C Cover HB-70/71, HF-72/73 & HD-74/75 Helmsman, SuperSport
<b>Item Code 067168</b>	Model N-203-C Cover FN-201/203, DN-200, SS-2000 Navigator, SuperSport
<b>Item Code 067169</b>	BN-C Cover BN-202 Navigator
<b>Item Code 067170</b>	LL-C Cover SS-5000 SuperSport
<b>Item Code 067172</b>	Cover HF-79 Helmsman Performer

### Protective Covers for Ritchie Compasses



13



067302/303



**RIEGLER GLOBEMASTER**

**Steel Boat & Commercial Boat Compasses Shock Mount Models**

- Special antivibration mounts
- Special model for steel boats
- Choice of 12, 24 and 32V green night lighting
- Exclusive 5-Year Ritchie Warranty

These Ritchie compasses are custom built: Delivery time: 2-3 weeks  
Please specify when ordering: Dial 5 or 6" (2 or 5°), 12, 24 or 32V and Sail Boat or Power Boat application.

Finish: B = Black, C = Chrome, X = Brass

**Item Code 067300 Model B-453 5"** (spec. for steel boats)

**Item Code 067301 Model B-463 6"** (spec. for steel boats)

**Item Code 067302 Model C-453 5"**

**Item Code 067303 Model C-463 6"**



067300/301



067312/322



**RIEGLER GLOBEMASTER**

**Binnacle Mount**

- Suitable for steel boats!

These Ritchie compasses are custom built: Delivery time: 2-3 weeks

Please specify when ordering: Dial 5 or 6" (2 or 5°), 12, 24 or 32V and Sail Boat or Power Boat application.

- Exclusive 5-Year Ritchie Warranty

Compasses from Item Code 067310 up to 067322 come with a hood with

the same finish as the binnacle.

Finish: B = Black, C = Chrome, X = Brass

**Item Code 067310 Model D-5-S-B 5"** Black

**Item Code 067311 Model D-5-S-C 5"** Chrome

**Item Code 067312 Model D-5-S-X 5"** Brass

**Item Code 067320 Model D-6-S-B 6"** Black

**Item Code 067321 Model D-6-S-C 6"** Chrome

**Item Code 067322 Model D-6-S-X 6"** Brass

**Item Code 067305 Model YB-500 5"** Black



067305/306



**Ritchie Helmsman™**

**Steel Boat & Commercial Boat Compass Model HB 845**

- 95mm (5°) Power Damp Dial
- Exclusive 5-Year Ritchie Warranty

**Item Code 067304 Compass Model HB-845**

**Item Code 067226 Resistor for use with 24V**





**Item Code 139040**

Plexiglass Course Plotter

**Breton Course Plotter**

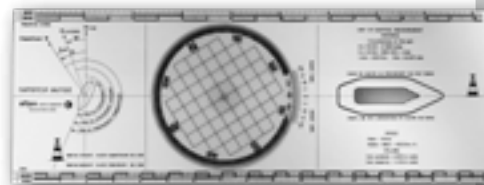

**Item Code 139043**

Plexiglass Parallel Ruler. L=300mm

**Jointed Parallel Ruler**



**Item Code 139045**

Plexiglass Protractor, 150mm

**Protractor 180°**



**Item Code 139044**

Plexiglass Square, 250mm, with handle

**Set Square**



**Item Code 139041**

L = 180mm Single Hand Dividers made of aluminum

**Dividers with fixed point**



**Item Code 139042**

L = 180mm





### First Aid Box

**Item Code 082180**

Small First Aid Box for Boat, Car, Caravan

**Item Code 082185**

First Aid Box type "B" Standard contents  
Complete with mounting bracket

**Item Code 082190**

First Aid Box type "A" Comprehensive contents  
Complete with mounting bracket



### Fire Blanket

**Item Code 082170**

Made of two sided coated fibre-glass fabric.

With mounting bracket.

Suitable for covering objects on fire. Dims. 90 x 90 cm.

Not suitable for frying fires.



### Discharge Opening For Fire Extinguisher

**Item Code 078945**

Fire extinguisher discharge opening with breakable glass.

Dims. 50 x 70 x 29mm

Mounting: 4 x M6



### Spray Foam Extinguisher ECOCOLD

**Item Code 082101**

Spray Foam Extinguisher 2l

Dims. Ø110, H=285mm (H=405mm incl. handle)

Frost Proof till -10C°

Fire Classes A+B+F

Incl. Bracket

**Item Code 082107**

Spray Foam Extinguisher 2l

Dims. Ø160, H=415mm (H=560mm incl. handle)

Frost Proof till -10C°

Fire Classes A+B+F

Incl. Bracket



### Dry Powder Extinguishers (permanent under pressure)

**Item Code 082116**

Dry Powder Extinguisher 1kg.

Dims. 350 x 85mm (H x Ø). Fire Class A,B,C.

**Item Code 082121** Dry Powder Extinguisher 2kg.

Dims. 395 x 110mm (H x Ø). Fire Class A,B,C.

The 1 & 2kg Powder Extinguisher come with solid mounting bracket. Horizontal & vertical mount.



### Built-in Box with Cover for Fire Extinguishers

**Item Code 484210**

Plastic Box with transparent Cover

Dims. 430x180x110 (lxwxh)

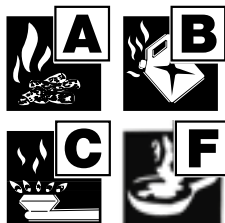

### Fire Classes

**Fire Class A** Ordinary Combustible Solids: Wood, Paper, Cloth, Plastics, Rubber, Coal, Carbon based compounds et cetera

**Fire Class B** Flammable & Combustible Liquids: Petrol, Oil, Paint, Thinners, Kerosene, Alcohol, et cetera

**Fire Class C** Flammable Gases: L.P.G., Butane, Acetylene, Hydrogen, Natural Gas and Methane et cetera

**Fire Class F** Boiling Oil and Fat like deep fat fryers

**Item Code 078884**

Nylon, Folding and adjustable. Cromed

**Item Code 078885**

Nylon, Folding and adjustable. Color white

A = 94mm, B = 98mm, C = 103mm

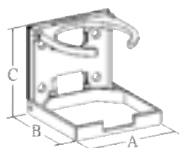

**Drink Holder**



**Item Code N0154097**

Drink holder, stainless steel 304

H=89mm, Ø67 to 87.3mm

**Drink Holder**



**Item Code N0154102**

Drink Holder Nylon, black

Inner Diameter: 76mm

Comes with three mounting adaptors

**Drink Holder**



**Item Code N0154096**

Drink holder, ring, stainless steel 316

H=63.5mm, Ø97x105mm

**Drink Holder**



**Item Code N0154095**

Drink holder, UV-stabilized plastic with rail mount bracket

**Drink Holder**



**Item Code N0154098**

Drink holder stainless steel 304

Folding, spring loaded 102x98mm (LxW)

**Drink Holder**



**Item Code 078887**

Drink holder, folding with stainless steel cover plastic spring grip  
Dims. 95 x 94 x 94 x 70mm (AxBxCxD)

**Drink Holder**



stainless steel  
316



**Stainless Steel  
Bollard**

Bolt mount from below

<b>Item Code 048300</b>	M8, H = 90mm, Ø50mm
<b>Item Code 048320</b>	M10, H = 120mm, Ø60mm
<b>Item Code 048340</b>	M12, H = 145mm, Ø70mm

stainless steel  
316



**Stainless Steel  
Bollards with  
Base or for  
Welding**

Bollards with Base (thickness 2mm)

<b>Item Code 048310</b>	Base dims. 90x90mm, H = 90mm, D=50mm
<b>Item Code 048330</b>	Base dims. 95x120mm, H= 120mm, D=60mm
<b>Item Code 048350</b>	Base dims. 120x150mm, H= 145mm, D=70mm

Bollards for welding

<b>Item Code 048305</b>	H = 90mm, D = 50mm
<b>Item Code 048325</b>	H = 120mm, D = 60mm
<b>Item Code 048345</b>	H = 145mm, D = 70mm
<b>Item Code 048480</b>	H = 195mm, D = 100mm, length of stock 1x75mm, 1 x35mm
<b>Item Code 048490</b>	H = 195mm, D = 100mm, length of stock 2x75mm

stainless steel  
316



**Stainless Steel  
Cross Bollards**

**Item Code 390500**

Base 160 x 55mm, Ø30mm, Stock 210mm, H = 95mm, M8

**Item Code 390501**

Base 200 x 60mm, Ø40mm, Stock 250mm, H= 100mm, M10

**Item Code 390502**

Base 240 x 80mm, Ø50mm, Stock 300mm, H= 110mm, M10

stainless steel  
316

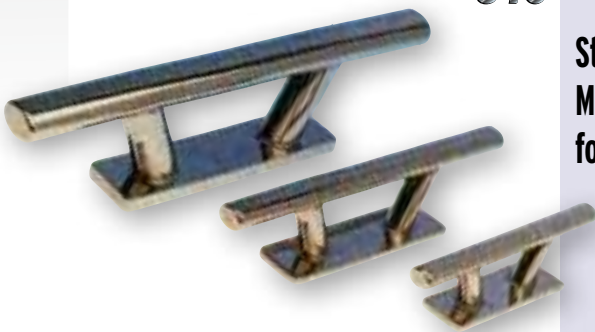

**Stainless Steel  
Mooring Cleats  
for Bolting**

**Item Code 048400** L=145mm, H= 45mm, Base dims: L=90mm, B=30mm, Hole centre distance 55mm

**Item Code 048410** L=205mm, H= 50mm, Base dims: L=120mm, B=35mm, Hole centre distance 65mm

**Item Code 048420** L=280mm, H= 75mm, Base dims: L=160mm, B=38mm, Hole centre distance 95mm

**Item Code 048430** L=320mm, H= 80mm, Base dims: L=170mm, B=38mm, Hole centre distance 105mm

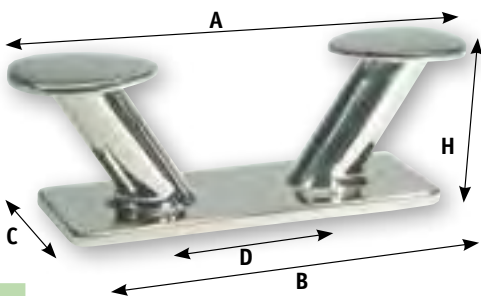

**Stainless Steel  
Horn Bollard**

stainless steel  
316

	A	B	C	D	H
<b>Item Code 072605</b>	240mm	188mm	70mm	90mm	80mm
<b>Item Code 072606</b>	300mm	254mm	80mm	130mm	100mm
<b>Item Code 072607</b>	350mm	298mm	90mm	170mm	110mm

- Item Code 209600 L = 60mm, B= 19mm
- Item Code 209800 L = 80mm, B= 22mm
- Item Code 209001 L = 110mm, B= 28mm
- Item Code 209005 L = 145mm, B= 35mm
- Item Code 209010 L = 180mm, B= 45mm
- Item Code 209015 L = 220mm, B= 52mm



Nylon Cleats

B= hole spacing

- Item Code 209602 L = 60mm, B = 19mm
- Item Code 209801 L = 80mm, B = 22mm
- Item Code 209002 L = 110mm, B = 28mm
- Item Code 209006 L = 145mm, B = 35mm
- Item Code 209011 L = 180mm, B = 45mm
- Item Code 209016 L = 220mm, B = 52mm

Nylon Cleats

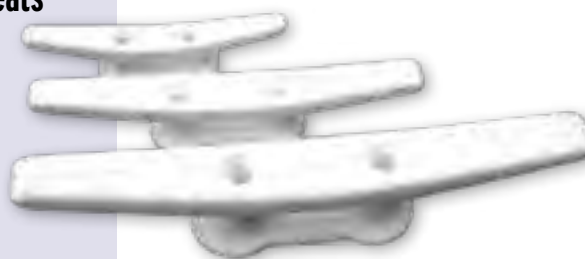

- Item Code 006150 L = 120mm per pair
- Item Code 006151 L = 150mm per pair

Nylon Fairleads



- Item Code 078401 L = 100mm, H = 25mm, Weight 110g, Hole centre distance 38mm
- Item Code 078402 L = 150mm, H = 30mm, Weight 220g, Hole centre distance 57mm
- Item Code 078403 L = 200mm, H = 35mm, Weight 320g, Hole centre distance 75mm
- Item Code 078404 L = 250mm, H = 45mm, Weight 650g, Hole centre distance 95mm
- Item Code 078405 L = 300mm, H = 53mm, Weight 1100g, Hole centre distance 100mm

Stainless Steel Mooring Cleats

stainless steel  
316

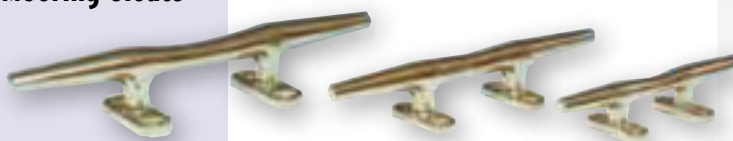

polished, stainless steel

Item Code	A	B	C	D	E	F	ØM
078830	200	34	120	55	67	34	10
078831	250	42	150	72	83	41	10

Stainless Steel Mooring Cleats



Item Code	A mm	B mm	C mm	D mm	ØM
078835	152	19	64	38	6
078836	203	25	83	51	8
078837	254	31	105	62	10

Stainless Steel Mooring Cleats





stainless steel  
316

### Stainless Steel Fairleads

**Item Code 613800** Right, L = 115mm, B = 27mm, H = 30mm

**Item Code 613801** Left, L = 115mm, B = 27mm, H = 30mm



078415  
078416

### Stainless Steel Fairleads

**Item Code 078410** L = 130mm, Ø max.= 16mm,  
Price per piece

**Item Code 078411** L = 150mm, Ø max.= 19mm,  
Price per piece

**Item Code 078415** L = 110mm, Ø max.= 13mm, Bow mount,  
Price per pair

**Item Code 078416** L = 150mm, Ø max.= 19mm, Bow mount,  
Price per pair

078410  
078411

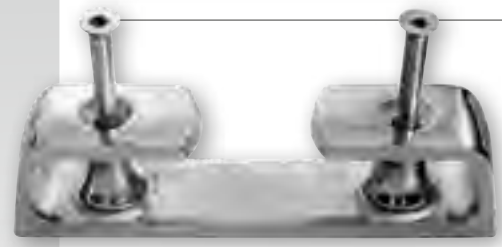

### Stainless Steel Fairlead Roller

Item Code	Max rope Ø	Base	Height
024285	16-22mm	40x205	55mm
024286	24-30mm	45x260	75mm



### Stainless Steel Mooring Cleats

		mounting holes	HtH
<b>Code N3081004</b>	L=102mm (4")	M6	31x40mm
<b>Code N3081005</b>	L=127mm (5")	M6	31x40mm
<b>Code N3081006</b>	L=152mm (6")	M6	40x40mm
<b>Code N3081008</b>	L=203mm (8")	M6	56x40mm
<b>Code N3081012</b>	L=305mm (12")	M8	73x48mm

## allpa



### Roller cleat

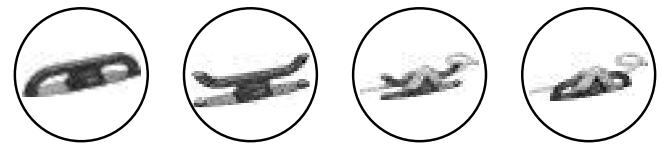

Roller is a folding cleat with rotating horns: with a simple gesture of your hand, you can open or close roller even with the line on, just by turning one of the horns. The horn can only be rotated inward. In this way, Roller can act as a footrest (outward rotation is locked). Available in 4 sizes and 2 finishes: silver or black anodized. Mounting screws included.

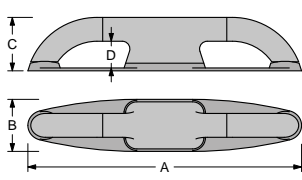

Item Code	A	B	C	D	SWL (kg)	Weight	Screws (mm)	Boat
<b>54RC230*</b>	232mm	46mm	46mm	21mm	2000kg	0,44kg	2 x Ø10 + 2 x Ø6	36 ft
<b>54RC290*</b>	287mm	55mm	56mm	28mm	4000kg	0,77kg	2 x Ø14 + 2 x Ø6	46 ft
<b>54RC350*</b>	346mm	64mm	65mm	31mm	7500kg	1,33kg	4 x Ø12 + 2 x Ø6	58 ft
<b>54RC420*</b>	418mm	76mm	77mm	36mm	11500kg	2,30kg	4 x Ø15 + 2 x Ø8	70 ft

\* For black finishing add `B` and for silver add `SI` to the item code.

**Item Code 078917** L=154,8 - B=54,7 - H=13,5 (mm)  
Hole center distance 85,5 - 2 x Ø8 (mm)

### Stainless Steel Foldaway Cleat



**Item Code 078918** L=202,0 - B=72,6 - H=15,0 (mm)  
Hole center distance 114,0 - 2 x Ø10 + 1 x Ø5,5 (mm)

Nice, rounded shape. No drainage required

Item Code	L	B	H1	H2	Mounting
078955	151	25	21	37	3 x M8 x 50 (mm)
078956	240	34	33	54	3 x M10 x 56 (mm)
078957	254	43	37	60	3 x M12 x 59 (mm)

### Stainless Steel X-Folding Cleat

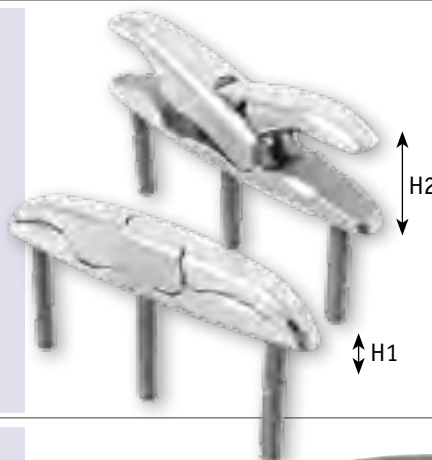

**Item Code 072250**

This cleat is simply pressed by hand to countersink it in the deck. Supplied with plastic adapter to discharge rain and seawater.

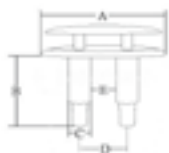

A = 126mm, B = 64mm, C = 22mm, D = 46mm, E = 22mm

### Stainless Steel Pop-Out Cleat



Stainless Steel A316 Spring loaded pop-out cleat. Drain barbs are already cast in. Aluminum backing plate and Nylock nuts included. Plastic drain adapter included.

Item Code	Model	A	B	C	D	E	F mm
078840	4 1/2"	124	81	23	98	21	14
078841	6"	165	93	23	128	35	18
078842	8"	212	118	32	152	26	24

### Stainless Steel Pop-Out Cleat

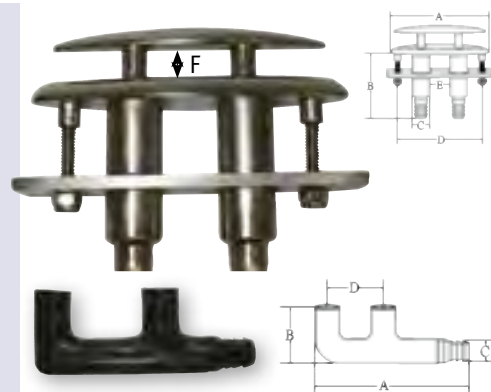

Stainless Steel A316 Full body pull up cleat that covers entire cleat base when stowed. Anti-rattle design.

Item Code	A	B	C	D	E	F mm
078950	108	28	50	45	19	19
078951	146	34	60	57	22	25
078952	202	37	70	70	25	31
078953	250	46	94	87	31	38

### Stainless Steel Pop-Out Cleat

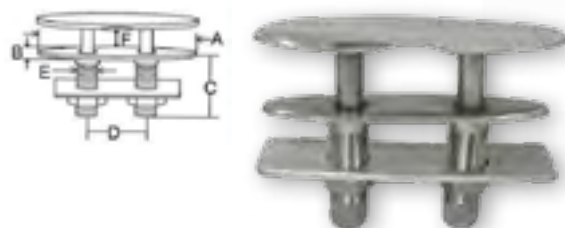

**Item Code 209150** L = 90mm, max. rope Ø10mm  
**Item Code 209151** L = 130mm, max. rope Ø14mm  
**Item Code 209152** L = 170mm, max. rope Ø18mm

### Aluminum Clam Cleats

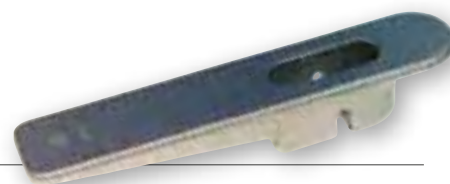

**Item Code N3100215** L = 215mm

Chrome-plated brass. With wooden stick.  
heart-heart = 9cm and 11.5cm

### Cross Bollards







**Stainless Steel with brandy-coloured leather cover**

- Item Code 73106859** L = 280mm
- Item Code 73106860** L = 380mm
- Item Code 73106861** L = 430mm
- Item Code 73106862** L = 585mm

L = Heart to Heart  
 Ø foot 57mm



With removable mounting plates.

*stainless steel*  
**316**

**Stainless Steel Grab Rails with Leather Covering**



Ø20mm, H = 55mm

- Item Code 613126** L = 400mm
- Item Code 613127** L = 600mm
- Item Code 613128** L = 800mm
- Item Code 613129** L = 1000mm, with centre support
- Item Code 613130** L = 1200mm, with centre support

**Stainless Steel Grab Rails**

*stainless steel*  
**316**



Stainless Steel A316 grab rails with mounting studs.  
 Ø22m, H = 55mm

- Item Code 024300** L= 300mm, M8 studs
- Item Code 024301** L= 450mm, M10 studs
- Item Code 024302** L= 610mm, M10 studs

**Stainless Steel Grab Rails**

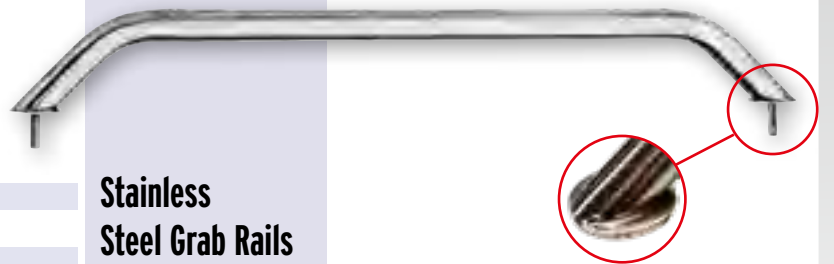

Stainless Steel A316 grab rails with mounting studs.  
 Ø25m, H = 55mm, M8 studs.

- Item Code 024305** L= 300mm, M8 studs
- Item Code 024306** L= 400mm, M8 studs
- Item Code 024307** L= 500mm, M8 studs

**Stainless Steel Grab Rails**



Die Cast Stainless Steel A316 handle for M8 mounting

- Item Code 024310** L = 170mm, H = 40mm

**Stainless Steel Handle**



Die Cast Stainless Steel A316 handle for M8 mounting

- Item Code 024315** L = 300mm, H = 50mm

*stainless steel*  
**316**

**Stainless Steel Handle**





## Stainless Steel 316 Gas Spring

- High quality stainless steel 316
- Diameter Cylinder Ø18mm
- Diameter Rod Ø8mm
- Temperature range: -20°C to + 70°C

Available with Balljoint or Eye Nut

Item Code	Stainless Steel Gas Spring	Mounting	Capacity
<b>M3718250</b>	Length 170-250mm	Eye Nut	18kg
<b>M3718251</b>	Length 170-250mm	Balljoint	18kg
<b>M3620501</b>	Length 290-500mm	Eye Nut	20kg
<b>M3620502</b>	Length 290-500mm	Balljoint	20kg
<b>M3725355</b>	Length 225-355mm	Eye Nut	25kg
<b>M3725356</b>	Length 225-355mm	Balljoint	25kg
<b>M3730600</b>	Length 350-600mm	Eye Nut	30kg
<b>M3730601</b>	Length 350-600mm	Balljoint	30kg
<b>M3638350</b>	Length 320-550mm	Eye Nut	35kg
<b>M3638351</b>	Length 320-550mm	Balljoint	35kg
<b>M3640500</b>	Length 290-500mm	Eye Nut	40kg
<b>M3640501</b>	Length 290-500mm	Balljoint	40kg
<b>M3650600</b>	Length 350-600mm	Eye Nut	50kg
<b>M3650601</b>	Length 350-600mm	Balljoint	50kg
<b>M3638500</b>	Length 320-550mm	Eye Nut	64kg
<b>M3638501</b>	Length 320-550mm	Balljoint	64kg
<b>64GS62920</b>	Stainless Steel 10mm Balljoint M8 with thread. (Set of 2)		
<b>269000</b>	Spare Stainless Steel Connector 316 10mm M8 for Gas Spring (Set of 2)		
<b>269001</b>	Spare Stainless Steel Eye Nut 316 M8 for Gas Spring (Set of 2)		



64GS62920



269001



269000

NAUTALIFT™ GAS LIFT SUPPORTS AND ACCESSORIES

- Marine Grade Gas Filled Supports
- Annealed steel rods, nitride coated for corrosion resistance
- Engineered polymer rod ends
- Bronze bushings
- Multi-lobe internal seal
- Exact fit OEM replacement - used by leading boatbuilders for over 20 years.

NAUTALIFT™  
GAS LIFT  
SUPPORTS

Item Code	Nautalift	Mounting	Capacity
64GS62640	Length 178-254mm	Balljoint	18kg
64GS62670	Length 216-305mm	Balljoint	14kg
64GS62690	Length 241-381mm	Balljoint	14kg
64GS62740	Length 279-432mm	Balljoint	18kg
64GS62800	Length 305-508mm	Balljoint	27kg
64GS62850	Stainless Steel Bracket 10mm Ballstud Length 57mm (Set of 2)		
64GS62870	Stainless Steel Bracket 90° 10mm Ballstud Length 51mm (Set of 2)		
64GS62900	Stainless Steel Bracket 90° 10mm Ballstud Length 51mm (Set of 2)		
64GS62920	Stainless Steel Ballstud 10mm with 5/16-18 thread (Set of 2)		
64GS62890	Balljoint Nautalift with thread (Set of 2)		



64GS62850



64GS62870



64GS62900



64GS62920



64GS62890



Item Code 024320 L = 220mm, Ø10,6mm

Item Code 024321 L = 270mm, Ø14,4mm

Stainless Steel Hatch  
Spring Opening Stay



Item Code 078850

A-max = 430mm, A-min = 300mm, B = 13mm

Stainless Steel Hatch  
Spring Opening  
Stay

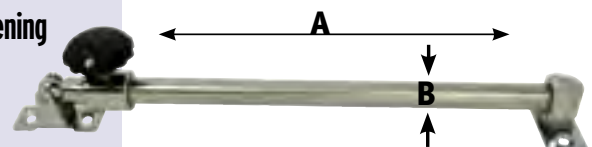



*stainless steel*  
**316**  
**T-Fitting**

<b>Item Code 072120</b>	T-Fitting, Left, 60°.	Tube Ø22,25mm
<b>Item Code 072121</b>	T-Fitting, Left, 60°.	Tube Ø25,4mm
<b>Item Code 072125</b>	T-Fitting, Right, 60°.	Tube Ø22,25mm
<b>Item Code 072126</b>	T-Fitting, Right, 60°.	Tube Ø25,4mm
<b>Item Code 072130</b>	T-Fitting, Universal, 60°.	Tube Ø22,25mm
<b>Item Code 072131</b>	T-Fitting, Universal, 60°.	Tube Ø25,4mm
<b>Item Code 072135</b>	T-Fitting, Universal, 90°.	Tube Ø22,25mm
<b>Item Code 072136</b>	T-Fitting, Universal, 90°.	Tube Ø25,4mm



**Grab Rail Fittings  
Stainless Steel**

<b>Item Code 072140</b>	90°-Fitting, Tube Ø22,25mm
<b>Item Code 072141</b>	90°-Fitting, Tube Ø25,4mm



**Spray-hood Fittings  
Stainless Steel**

<b>Item Code 072150</b>	Centre Piece. For Tube Ø22,25mm, Connection 6,3mm
<b>Item Code 072151</b>	Centre Piece. For Tube Ø25,4mm, Connection 6,3mm



**Spray-hood Fittings  
Stainless Steel**

<b>Item Code 072145</b>	End fitting. For Tube Ø22,25mm, Connection 6,3mm
<b>Item Code 072146</b>	End fitting. For Tube Ø25,4mm, Connection 6,3mm



**Sprayhood  
Fittings  
Stainless Steel**

Stainless Steel A316 Insert Eye for sprayhood tube.

<b>Item Code 078960</b>	End fitting for 7/8" tube (22,25mm), A= 18,8mm, B = 30mm, C = 8mm
<b>Item Code 078961</b>	End fitting for 1" tube (25,4mm), A= 21,5mm, B = 30mm, C = 8mm



**"quick release"  
Sprayhood  
Fittings**

<b>Item Code 072175</b>	Ø22mm Stainless Steel Sprayhood quick release fitting
<b>Item Code 072176</b>	Ø25mm Stainless Steel Sprayhood quick release fitting



*stainless steel*  
**316**  
**Sprayhood  
Fittings  
Stainless Steel**

Stainless Steel A316 Hinge Jaw Slide. Captured pin design prevents the two halves from separating.

Item Code	A	B	C
<b>078965</b>	A = 22,25mm, B = 28,6mm, C = 66,7mm		
<b>078966</b>	A = 25,40mm, B = 28,6mm, C = 66,7mm		
<b>078967</b>	A = 31,75mm, B = 28,6mm, C = 73,0mm		



**Sprayhood  
Fittings  
Stainless Steel**

Removable, Stainless Steel A316 Deck Hinge Ball Style Top Cap. Ball joint allows 30° side travel and 190° forward and backward movement.

Item Code	A	B	C	D
<b>078970</b>	22,4	82	30	42
<b>078971</b>	25,6	82	30	42
<b>078972</b>	Spare Locking Pin (Kit)			

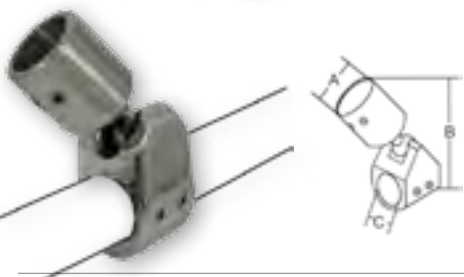

*stainless steel*  
**316**  
**Sprayhood  
Fittings  
Stainless Steel**

Stainless Steel A316 Jaw Slide Ball Style Top Cap. Ball joint allows 30° side travel and 190° forward and backward movement.

Item Code	A	B	C
<b>078975</b>	22,4	97	22,25 (mm)
<b>078976</b>	25,6	97	25,4 (mm)

**Item Code 072160** Deck Mounted Angled Feet  
with screw 6,3mm, Base 22x51mm

**Spray-hood Fittings  
Stainless Steel**

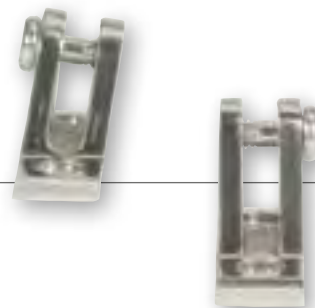

**Item Code 072155** Deck Mounted Straight Feet with screw  
6,3mm, Base 22x51mm

**Spray-hood Fittings  
Stainless Steel**

**Item Code 072660**  
with Adjustable Fixed Positioning  
26 x 69mm. Mounting Ø6mm

*stainless steel*  
**316**  
**Deck Mounted  
Hinge Bracket**

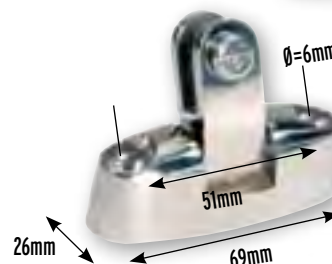

Stainless Steel A316 Removable Deck Hinge.  
Push release button to remove bimini top assembly.

**Sprayhood  
Fittings  
Stainless Steel**

Item Code	A	B	C	D
078980	75	35	43	8 (mm)



**Item Code 072100** Deck Socket 90°, Square Base  
Tube Ø22,25mm, Base 76 x 43

**Guard Railing  
Fittings  
Stainless Steel**

**Item Code 072101** Deck Socket 90°, Square Base  
Tube Ø25,4mm, Base 81 x 48mm

*stainless steel*  
**316**

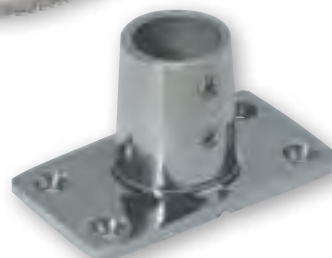

**Item Code 072105** Deck Socket, 90° Round Base  
Tube Ø22,25mm, Base Ø66mm

*stainless steel*  
**316**  
**Guard Railing  
Fittings  
Stainless Steel**

**Item Code 072106** Deck Socket, 90° Round Base  
Tube Ø25,4mm, Base Ø71mm



**Item Code 072110** Deck Socket 60°, Square Base  
Tube Ø22,25mm, Base 76 x 43mm

**Guard Railing  
Fittings  
Stainless Steel**

**Item Code 072111** Deck Socket 60°, Square Base  
Tube Ø25,4mm, Base 81 x 48mm

*stainless steel*  
**316**



**Item Code 072115** Deck Socket 60° Round Base  
Tube Ø22,25mm, base Ø66mm

**Guard Railing  
Fittings  
Stainless Steel**

**Item Code 072116** Deck Socket 60°, Round Base  
Tube Ø25,4mm, base Ø71mm

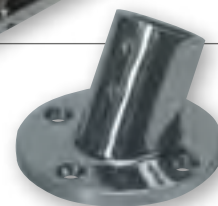

**Item Code 495005** Open T-Fitting 90°  
For Tube Ø22mm, with plastic insert

**Open T-Fitting  
Stainless Steel**



**Item Code 495009** L= 50mm, For Tube Ø22mm  
Hole pitch 32mm

**Windscreen Bracket  
Stainless Steel**





stainless steel  
316

**Grab Rail End Fitting**

Item Code N0980121 Grab Rail End Fitting 1" (25,4mm).



**Grab Rail Fittings  
Stainless Steel**

Item Code 072205 End Fitting 60°  
Tube Ø22,25mm, Height 49mm  
Item Code 072206 End Fitting 60°  
Tube Ø25,4mm, Height 57mm

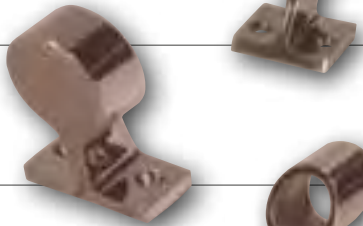

**Grab Rail Fittings  
Stainless Steel**

Item Code 072215 End Fitting 120°  
Tube Ø22,25mm, Height 37mm  
Item Code 072216 End Fitting 120°  
Tube Ø25,4mm, Height 56mm

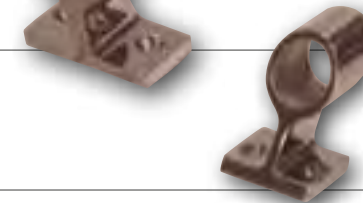

**Grab Rail Fittings  
Stainless Steel**

Item Code 072210 End Fitting 60°  
Tube Ø22,25mm, Height 49mm  
Item Code 072211 End Fitting 60°  
Tube Ø25,4mm, Height 57mm



**Tubing for Spray  
Hoods, Guard Railing  
& Grab Rails**

Item Code 495BUIS S/S. 60°, tube Ø22,25mm,  
H= 49mm, Hole Ø5mm, hole pitch 26mm  
Item Code 495BUIS1 S/S. 60°, tube Ø25,4mm,  
H= 57mm, Hole Ø5mm, hole pitch 27mm

stainless steel  
316



**Spray-hood Fittings  
Stainless Steel**

Item Code 072165 Side Mounted Feet  
with screw 5mm, Base 22x51mm,  
2xØ5mm



**Spray-hood Fittings  
Stainless Steel**

Item Code 072170 Side Mounted Feet, extra heavy  
Base 72 x 47mm, M5 screw  
4xØ6mm



**Swivel Webbing  
Buckle Kit  
for Sun Top**

Stainless Steel A316 Buckle, Pad Eye, Swivel Pin and Snaphook  
with 25x2300mm nylon webbing. Breaking load 400kg.

Item Code 098100



**Webbing  
with Buckle**

Stainless Steel A316 Buckle with 25x2300mm nylon webbing.  
Breaking load 400kg.

Item Code 098101 Set of 2.



**Battery Box or  
Fuel Tank Hold  
Down Strap Kit**

Stainless Steel A316 Buckle and Strap Holder with  
25x2300mm nylon webbing. Breaking load 400kg.

Item Code 098102

Stainless Steel A316 Spring Loaded Cam Latch.

**Item Code 098105**

**Compression Fastener**

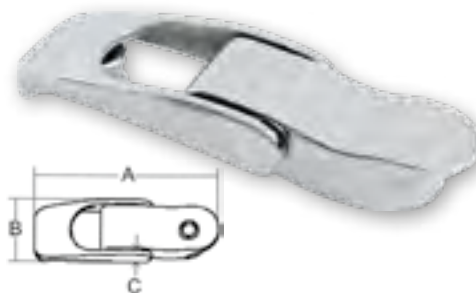

Stainless Steel A316 Cam Over latch.  
Elongated wire loop is tensioned when latched.

**Item Code 098107**

**Cam Over Latch**

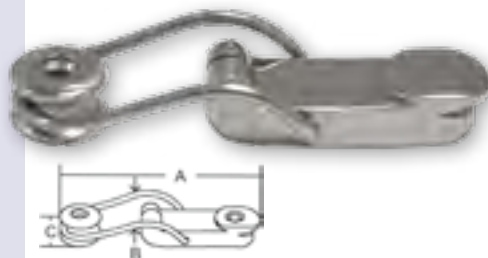

Stainless Steel A316 Anti-Rattle Door Fastener

**Item Code 024325** 70 x 18mm  
(minimum length x cam width)

**Item Code 495018** 120 x 26mm  
(minimum length x cam width)

**Anti-Rattle Door Fastener**



**Item Code 078440**  
S/S Swivel hasp, L x B = 66 x 30mm

*stainless steel 316*  
**Stainless Steel Swivel Hasp**



**Item Code 078860**  
A = 100mm, B = 46mm, C = 75mm

**Stainless Steel Anti-Rattle Door Fastener**

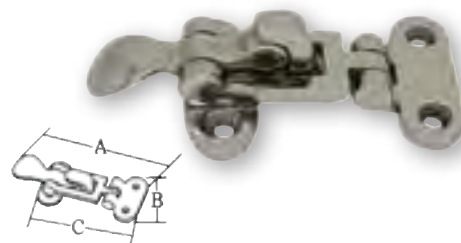

**Item Code 078870** A = 90mm, B = 25mm, C = 9mm  
**Item Code 078871** A = 75mm, B = 25mm, C = 9mm

*stainless steel 316*  
**Stainless Steel Swivel Hasps**



**Item Code 078865**  
A = 90mm, B = 38mm,  
C = 36mm, D = 17mm

*stainless steel 316*  
**Stainless Steel Barrel Bolt**

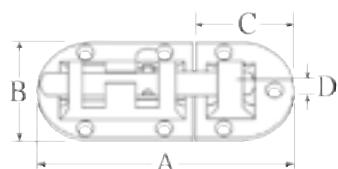

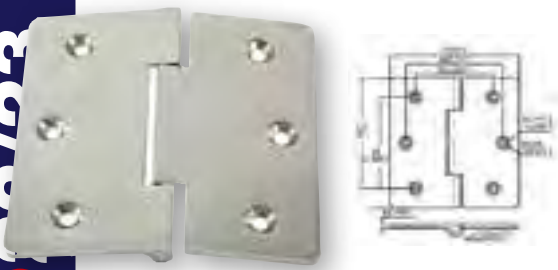

### Stainless Steel A316 Hinge

Item Code 098205 Very low profile, 127 x 127mm

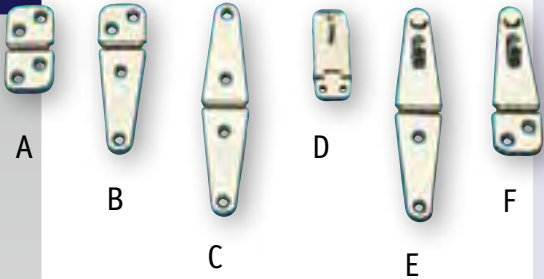

### Stainless Steel Hinges

Item Code 490100	(A)	L = 60mm,	B = 32mm,	Mounting 5mm
Item Code 490200	(B)	L = 103mm,	B = 32mm,	Mounting 5mm
Item Code 490300	(C)	L = 145mm,	B = 32mm,	Mounting 5mm
Item Code 490400	(D)	L = 64mm,	B = 32mm,	Mounting 5mm
Item Code 490500	(E)	L = 145mm,	B = 32mm,	Mounting 5mm
Item Code 490600	(F)	L = 103mm,	B = 32mm,	Mounting 5mm

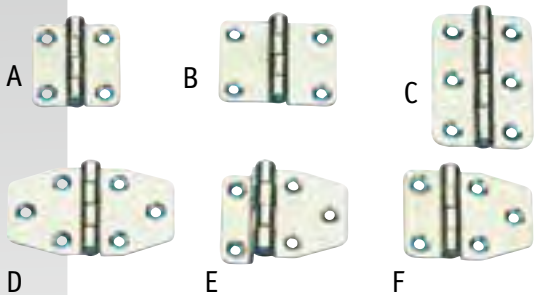

### Stainless Steel Hinges

Item Code 490700	(A)	L = 36mm,	B = 37mm,	Mounting 4mm
Item Code 490800	(B)	L = 48mm,	B = 37mm,	Mounting 4mm
Item Code 490900	(C)	L = 41mm,	B = 60mm,	Mounting 4mm
Item Code 491000	(D)	L = 64mm,	B = 37mm,	Mounting 4mm
Item Code 491200	(E)	L = 48mm,	B = 37mm,	Mounting 4mm
Item Code 491300	(F)	L = 50mm,	B = 37mm,	Mounting 4mm

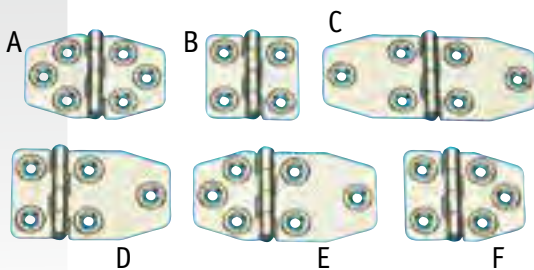

### Stainless Steel Hinges

Item Code 491100	(A)	L = 68mm,	B = 46mm,	Mounting 5mm
Item Code 491400	(B)	L = 44mm,	B = 46mm,	Mounting 5mm
Item Code 491500	(C)	L = 102mm,	B = 46mm,	Mounting 5mm
Item Code 491600	(D)	L = 73mm,	B = 46mm,	Mounting 5mm
Item Code 491700	(E)	L = 85mm,	B = 46mm,	Mounting 5mm
Item Code 491800	(F)	L = 56mm,	B = 46mm,	Mounting 5mm



### Stainless Steel "Take Apart" Hinge

Item Code 072680  
37 x 92mm. Mounting hole ø5mm

stainless steel  
**316**

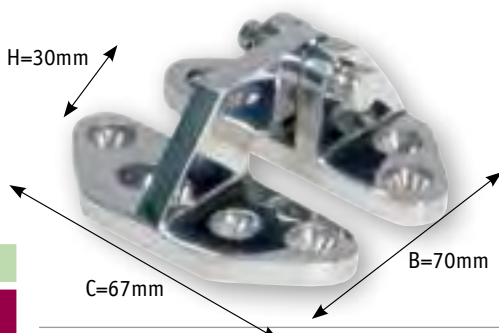

### Stainless Steel Hinge for Hatch

Item Code 072655

stainless steel  
**316**



Black nylon hinge with stainless steel pin  
**Item Code 124845** 145 x 40mm

**Nylon hinge**



Black nylon hinge with stainless steel pin  
**Item Code 124805** 105 x 40mm

**Nylon hinge**



Black nylon hinge with stainless steel pin  
**Item Code 124760** 60 x 40mm

**Nylon hinge**



Black nylon hinge with stainless steel pin  
**Item Code 124750** 50 x 40mm

**Nylon hinge**

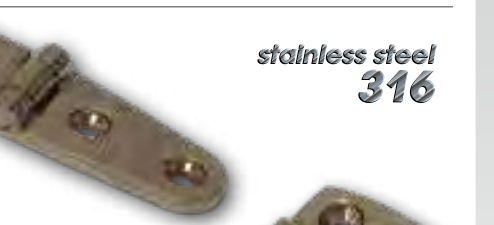

**Item Code 072220** L = 102mm, B = 26mm

**Item Code 072221** L = 153mm, B = 27mm

**Stainless Steel  
Die Cast Hinges**

*stainless steel*  
**316**

**Item Code 072225** L = 57mm, B = 38mm  
H = 4mm, ø hinge pin 9mm

**Item Code 072226** L = 76mm, B = 38mm  
H = 5mm, ø hinge pin 9mm

**Stainless Steel  
Die Cast Hinges**



**Item Code 072230** 76x38x4mm (lxbxh)  
**Item Code 072231** 102x38x5mm (lxbxh)  
**Item Code 072235** 38x38x4mm (lxhxb)  
hole pitch 23,5x23,5 - Ø5mm

**Item Code 072236** 48x48x4mm (lxhxb)  
hole pitch 35x34 - Ø5mm

**Stainless Steel  
Die Cast Hinges**



**Item Code N0052563** 38x35x35mm

**Stainless steel 316  
Hinge**



**Item Code N0052533** 75x37x37mm

**Stainless steel 316  
Hinge**



**Item Code N0052599** 100x130x4mm

**Stainless steel 316  
Hinge**



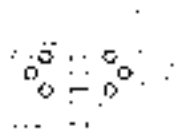

**Stainless Steel  
A316  
Covered Hinge**

**Item Code 098110** 37 x 76,2 x 2mm

All these hinges have an easy fitted cover with 3M double side adhesive tape thus concealing fasteners. Covers can be removed by using a heat gun or hair dryer. Bright polish finish. These hinges have passed a 500 hours salt-spray test.

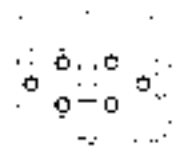

**Stainless Steel  
A316  
Covered Hinge**

**Item Code 098111** 37 x 76,2 x 2mm

*stainless steel*  
**316**

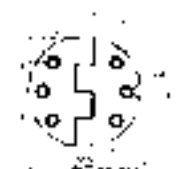
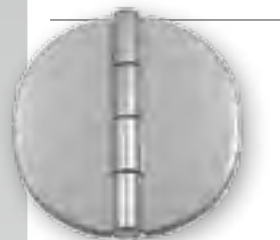

**Stainless Steel  
A316  
Covered Hinge**

**Item Code 098112** 64,7 x 64,7 x 2mm

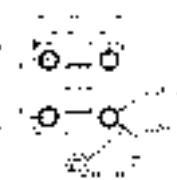

**Stainless Steel  
A316  
Covered Hinge**

**Item Code 098113** 37 x 36 x 2mm

*stainless steel*  
**316**

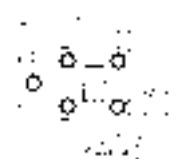
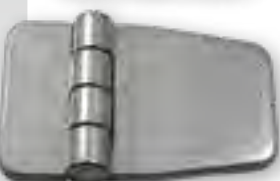

**Stainless Steel  
A316  
Covered Hinge**

**Item Code 098114** 37 x 56 x 2mm

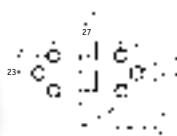

**Stainless Steel  
A316  
Covered Hinge**

**Item Code 098115** 37 x 76 x 2mm

*stainless steel*  
**316**

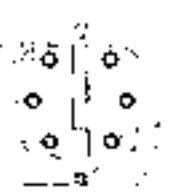

**Stainless Steel  
A316  
Covered Hinge**

**Item Code 098116** 75 x 75 x 2mm

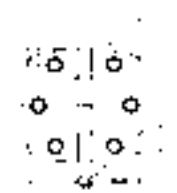

**Stainless Steel  
A316  
Covered Hinge**

**Item Code 098117** 75 x 75 x 2mm

*stainless steel*  
**316**

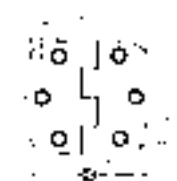

**Stainless Steel  
A316  
Covered Hinge**

**Item Code 098118** 75 x 74 x 3mm

*stainless steel*  
**316**

Stainless Steel A316 Self-Closing Slam Latch.  
New full handle design. Anti-rattle design.

	A	B	C	D
<b>Item Code</b> 098120	9-22	19-25	54	45

**Grand Slam Latch**

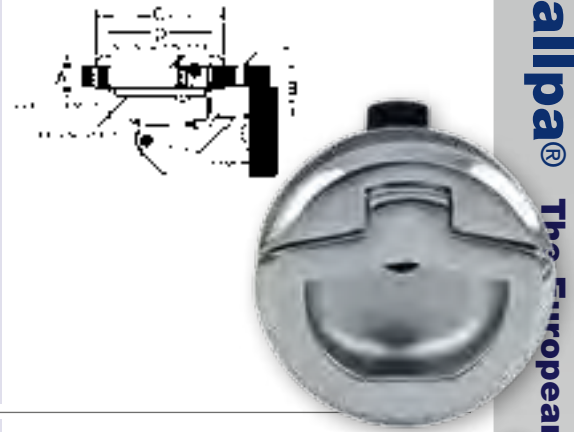

Stainless Steel A316 Watertight Compression Latch.

	A	B	C	D	E	F
<b>Item Code</b> 098121	8-25	22-76	62	50	71	54

**Item Code** 098121/L Idem with lock

**Watertight Round Grand Compression Latch**



*stainless steel*  
**316**

Watertight Slam Latch. Anti-rattle design.

	A	B	C	D
	4-13	25	61	50

**Item Code** 098122 Handle and housing made of Stainless Steel.

**Item Code** 098123 As above but with nylon housing.

Max. door thickness may be 22mm by using longer screw.  
Comes with 3mm spacer ring.

**Watertight Slam Latch**



Stainless Steel A316 Compression Latch with mirror polished cover.

	A	B	C	D	E	F
<b>Item Code</b> 024330	110	115	91	51	15	75

**Round Grand Compression Latch**



**Item Code** 098119 Compression latch with chrome T-handle and black polymer body  
Material thickness up to 60mm.  
Rattle free  
A = 3-19mm, B = 19-60mm, C = 75mm,  
D = 63,5mm, E = 58mm, F = 60mm  
Keys are uniform.

**Watertight Round Grand Compression Latch**



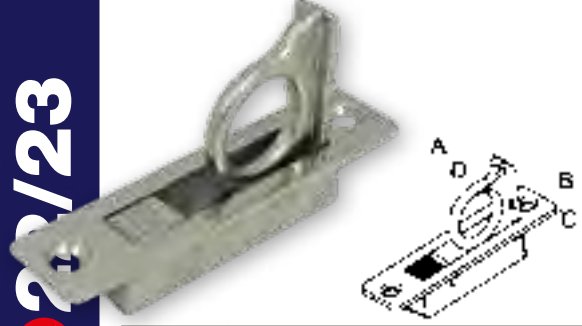

### Stainless Steel Pull Ring

stainless steel  
**316**

Stainless Steel A316 Flush Hatch Pull Ring. Pop Out Design.

	A	B	C	D
Item Code 098140	83	21	12+16(ring)	19 (mm)



### Plastic Slam Latch

Round Plastic Slam Latch for light and medium weight doors. Outer Ø60mm, cut out size Ø50mm.

- Item Code N3050018 White plastic latch
- Item Code N3050021 Black plastic latch

For material thickness 8-12mm

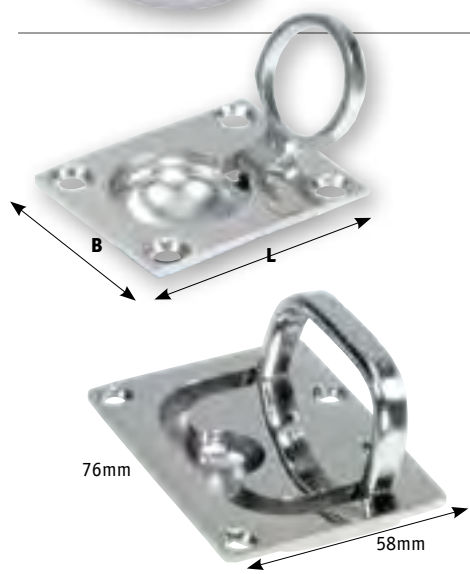

### Stainless Steel Lift Ring

stainless steel  
**316**

- Item Code 072620 L x B = 48 x 38mm
- Item Code 072625 L x B = 64 x 46mm

- Item Code 072630 L x B = 76 x 58mm



### Stainless Steel Magnetic holder

- Item Code 269017 Set of magnetic door / cabinet holders  
Dims. L = 55mm, B = 39mm, D = 17mm



### Stainless Steel Magnetic holder

- Item Code 269015 Single magnetic door / cabinet holder  
Dims. L = 26mm, B = 32mm, D = 15mm

- Item Code 269016 Single magnetic door / cabinet holder with rubber stopper.  
Dims. L = 26mm, B = 32mm, D = 15mm

stainless steel  
**316**

Stainless Steel A316 Magnetic Door Latch.  
Anti-rattle design.

	A	B	C	D	Door thickness
Item Code 098125	62	75	92	70	19-25,4 (mm)
Item Code 098126	62	75	92	70	28,5-35 (mm)

### Stainless Steel Magnetic Door Latch



Stainless Steel A316 Magnetic Door Latch with interior lock knob.  
Key locks outside. Works on curved door. Anti-rattle design.

	A	B	C-min.			
	58	100	16			
Item Code 078905	Door latch with left lever.					
Item Code 078906	Door latch with right lever.					
	D	E	F	G		
Item Code 078910	Strike 19	70	14	6		
Item Code 078911	Strike 21	70	22	10		

### Stainless Steel Magnetic Door Latch



Stainless Steel A304 Magnetic Door Catch. Rotating and  
adjustable in height and angle. Holding power 3,5kg.

	A	B	C	D	E	F
Item Code 098130	69-85	51	51	28,5	58	14,5 (mm)

### Stainless Steel Magnetic Door Catch



Stainless Steel A316 Door Stop Catch with rubber bumper stop.

	A	B	C	D
Item Code N0085019	61	17	50	30 (mm)

### Stainless Steel Door Catch

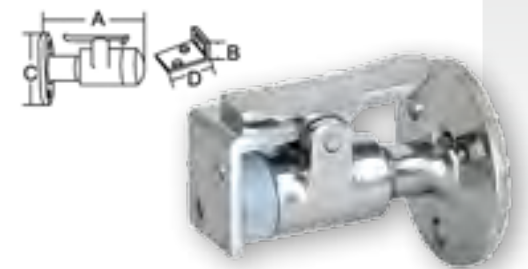

Stainless Steel A304 Spring Loaded Pull Pin Latch. Bore Ø16mm.

	A	B	C	D
Item Code 098135	9,5	56,5	28	13 (mm)

### Stainless Steel Pull Pin Latch

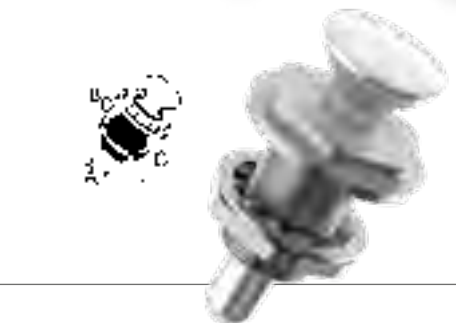

Stainless Steel A316 Flush Hatch Pull Ring. Pop Out Design.  
Ø42 x Ø31mm, L=49,4 - 43,0mm

Item Code M3550095

### Pop-Out Knob Latch





**Plastic Hatch**



Watertight inspection and access hatch made of tough, UV-resistant PP (polypropylene). Lid opens 180°. Lid and hinge are removable. Lock can be ordered separately.

- Item Code 484161 (White)**
- Item Code 484161/G (Gray)**
- Item Code 484161/Z (Black)**

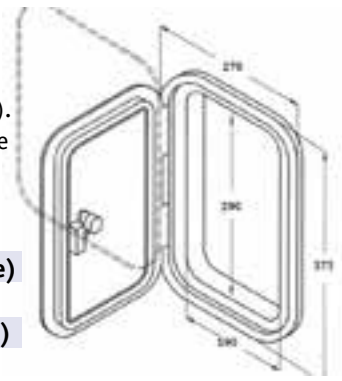

**Plastic Hatch**



Watertight inspection and access hatch made of tough, UV-resistant PP (polypropylene). Lid opens 180°. Lid and hinge are removable. Lock can be ordered separately.

- Item Code 484162 (White)**
- Item Code 484162/G (Gray)**
- Item Code 484162/Z (Black)**

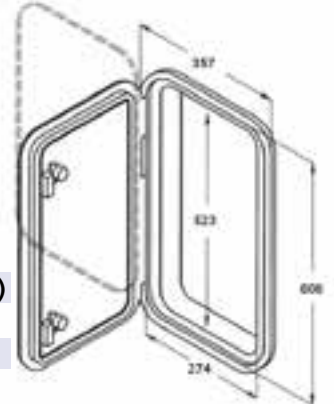

**Plastic Hatch**



Watertight inspection and access hatch made of tough, UV-resistant PP (polypropylene). Lid opens 180°. Lid and hinge are removable. Lock can be ordered separately.

- Item Code 484163 (White)**
- Item Code 484163/G (Gray)**
- Item Code 484163/Z (Black)**

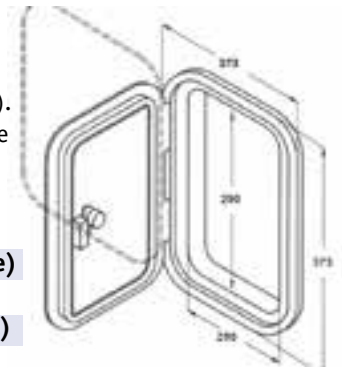

**Plastic Hatch**



Watertight inspection and access hatch made of tough, UV-resistant PP (polypropylene). Lid opens 180°. Lid and hinge are removable. Lock can be ordered separately.

- Item Code 484164 (White)**
- Item Code 484164/G (Gray)**
- Item Code 484164/Z (Black)**

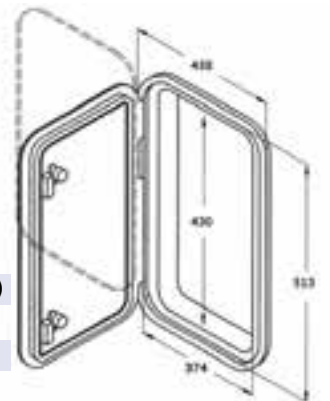

**Lock**

Lock set for over mentioned hatches. Including spare key.

- Item Code 484169 (White)**
- Item Code 484170 (Gray)**
- Item Code 484171 (Black)**

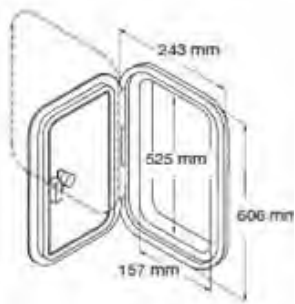

Watertight inspection and access hatch made of tough, UV-resistant PP (polypropylene). Lid opens 180°. Lid and hinge are removable. Lock can be ordered separately.

- Item Code 484166 (White)**
- Item Code 484166/G (Gray)**
- Item Code 484166/Z (Black)**

**Plastic Hatch**

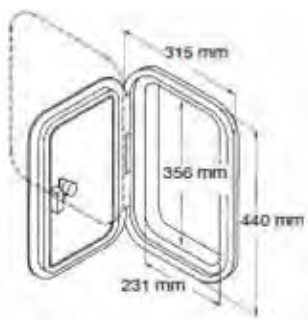

Watertight inspection and access hatch made of tough, UV-resistant PP (polypropylene). Lid opens 180°. Lid and hinge are removable. Lock can be ordered separately.

- Item Code 484167 (White)**
- Item Code 484167/G (Gray)**
- Item Code 484167/Z (Black)**

**Plastic Hatch**

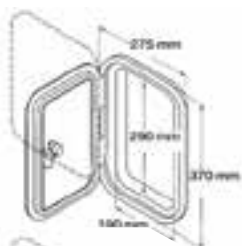

Watertight inspection and access hatch made of tough, UV-resistant PP (polypropylene) in white color. Lid opens 180°.

- Item Code 484130 A**

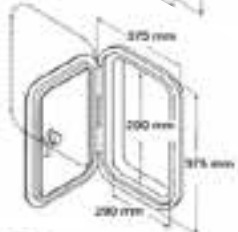

- Item Code 484135 B**

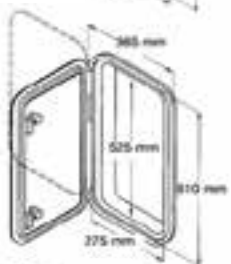

- Item Code 484140 C**

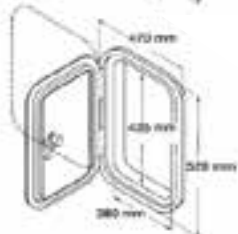

- Item Code 484145 D**

**Plastic Hatch**

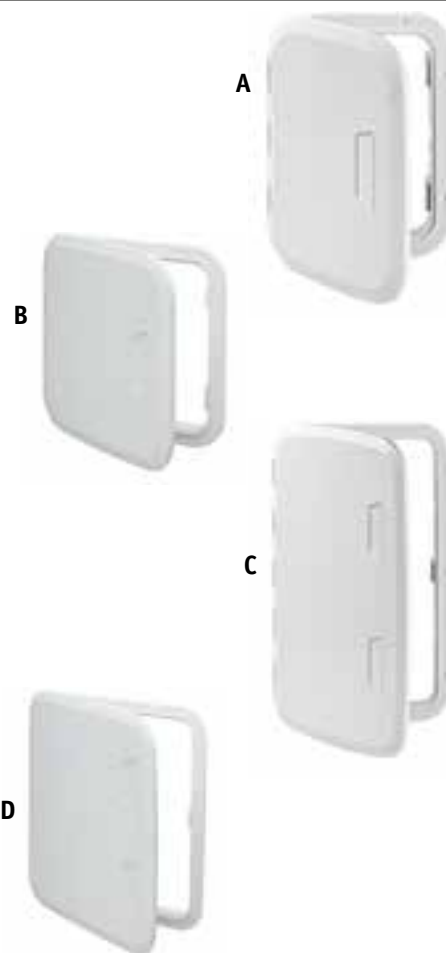

Lock set for over mentioned hatches. Including spare key.

- Item Code 484169 (White)**
- Item Code 484170 (Gray)**
- Item Code 484171 (Black)**

**Lock**



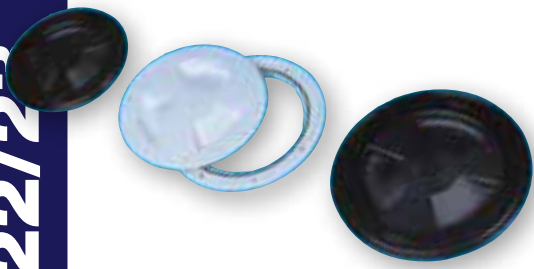

### Inspection Hatches

<b>Item Code 004477</b>	Small Ø 104 x 143mm Black
<b>Item Code 004477/W</b>	Small Ø 104 x 143mm White
<b>Item Code 004478</b>	Medium Ø 130 x 170mm Black
<b>Item Code 004478/W</b>	Medium Ø 130 x 170mm White
<b>Item Code 004479</b>	Large Ø 155 x 200mm Black
<b>Item Code 004479/W</b>	Large Ø 155 x 200mm White



### Plastic Inspection Hatch, with Lock

<b>Item Code 1643585</b>	Small Model A = 235mm, B = 190mm, C = 265mm, F = 210mm
<b>Item Code 1643579</b>	Large Model A = 250mm, B = 235mm, C = 315mm, F = 265mm
<b>Item Code 1642791</b>	Small Model A = 235mm, B = 190mm, C = 265mm, F = 210mm
<b>Item Code 1643565</b>	Large Model A = 250mm, B = 235mm, C = 315mm, F = 265mm



### Stainless Steel Inspection Hatch

<b>Item Code 072671</b>	4" (102mm) Bore Ø111mm Outer Ø139mm. Including key.
<b>Item Code 072671/S</b>	Spare Key



### Plastic Deck Plate with Bag

<b>Item Code N0719155</b>	Plastic deck plate with storage bag Ø210x160mm, cut out size Ø170mm
---------------------------	--



### Sturdy Plastic Hatches

<b>Item Code N5882/W</b>	Lid size: 185x245mm Without lock. For installation of shower or control panel.
--------------------------	---



### Built-in Box with Cover for Fire Extinguishers

<b>Item Code 484210</b>	Plastic Box with transparent Cover Dims. 430x180x110 (lxwxh)
-------------------------	---



Black plastic built-in box with white cover. Cover opens 180°. Cover and hinge are removable.  
 Dims. (w x h x d): 270 x 373 x 190mm = depth installation  
 Internal depth = 160mm

**Built-in Box**

**Item Code 484220**

Black plastic built-in box with white cover. Cover opens 180°. Cover and hinge are removable.  
 Dims. (w x h x d): 459 x 514 x 330mm

**Built-in Box**

**Item Code 484222**

Black plastic built-in box with white cover. Cover opens 180°. Cover and hinge are removable.  
 Dims. (w x h x d): 459 x 514 x 330mm

**Built-in Box**

**Item Code 484224**

Black plastic built-in box with white cover. Cover opens 180°. Cover and hinge are removable.  
 Dims. (w x h x d): 459 x 514 x 335mm

**Built-in Box**

**Item Code 484226**

Lock set for over mentioned hatches. Including spare key.

**Lock**

**Item Code 484169 (White)**

**Item Code 484170 (Gray)**

**Item Code 484171 (Black)**

Aluminum hatches, lid can be taken out, water tight, can be stepped on, very strong!

**Aluminum Hatches**

Item Code	
494113	Color grey, RAL9006, powder coated
494123	Color black, powder coated
494116	Blank, uncoated aluminum
Gasket (p.m.)	Inner size: 270 x 370mm (H x W) Outer size: 160 x 260mm (H x W) Cut out size: 206 x 306mm (H x W)
494110	

Item Code	
494112	Color grey, RAL9006, powder coated
494111	Color black, powder coated
494117	Blank, uncoated aluminum
Gasket (p.m.)	Inner size: 350 x 600mm (h x b) Outer size: 240 x 490mm (h x b) Cut out size: 286 x 537mm (h x b)
494110	

Item Code	
494114	Color grey, RAL9006, powder coated
494124	Color black, powder coated
494115	Blank, uncoated aluminum
Gasket (p.m.)	Inner size: 510 x 460mm (h x b) Outer size: 400 x 345mm (h x b) Cut out size: 446 x 393mm (h x b)
494110	



**Fixed Portlights  
Stainless Steel**

Item Code	External dimensions	Mounting dimensions
484300	127 x 400mm	94 x 363mm
484301	151 x 490mm	120 x 458mm
484302	198 x 457mm	146 x 405mm



484300



484301



484302

**Opening  
Portlights  
Stainless Steel  
Incl. Fly screen**

Item Code	External dimensions	Mounting dimensions
484305	203 x 461mm	156 x 414mm
484306	216 x 472mm	163 x 428mm
484307	216 x 472mm	186 x 430mm



484305



484306



484307

Wall thickness 20mm  
Glass 10mm thick

OPAL portlights naturally fit perfectly with OPAL hatches and have some unique features:

- A sturdy frame made of one piece of aluminum, which ensures excellent rigidity, together with a double sealing profile for a perfect water barrier.
- Only one version per model suitable for many wall thicknesses:
  - 5 to 33 mm for folding portholes.
  - 8 to 30 mm for fixed portholes.
- Optimal visibility due to non-obstructing position of the closing trade.
- Open and close with one hand.

**Edit**

The portlights must be mounted on a flat surface, with a permitted tolerance of approx. 1 mm. The portlights are standard equipped with 10 mm thick blue acrylic glass.

**To open**

Due to the single, ergonomic handle, the partridge gate can be opened with just one hand. This trade also distributes the pressure on the entire sealing profile, making an excellent water resistance guaranteed.





**Watertightness**

The Opal portlights have a double sealing system. Upon closure, the first lip holds back the water while the second lip ensures absolute water tightness. The 46 degree profile of the frame ensures excellent drainage and the portholes are therefore also suitable for installation in (sloping) wheelhouse roofs.

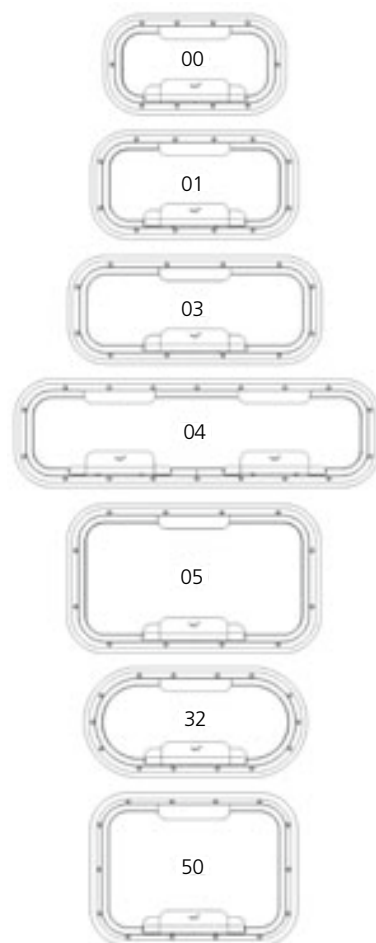
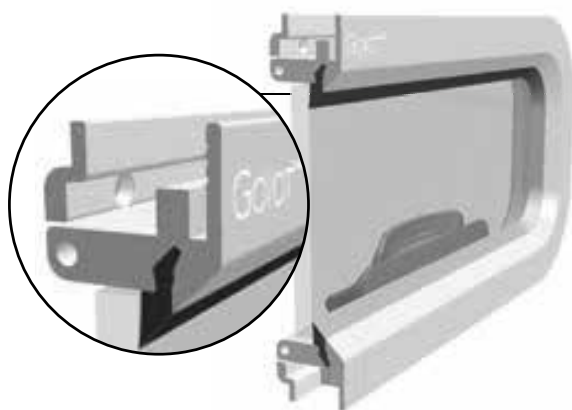

**OPAL Portlights**



Model	Item Code	version	 mm	 mm	 mm	 kg
00	<b>73106928</b>	opening	303 x 156	56	325 x 178	1.8
01	<b>73105268</b>	opening	347 x 171	56	369 x 193	2
03	<b>73115006</b>	opening	429 x 171	56	451 x 193	2.7
04	<b>73105269</b>	opening	627 x 171	56	649 x 193	3.8
05	<b>73106930</b>	opening	429 x 244	56	451 x 266	3.4
32	<b>73105125</b>	opening	375 x 175	87.5	397 x 197	2
50	<b>73105126</b>	opening	347 x 251	56	369 x 273	3



bino

PVC Fender Profile "BINO" for work boats offers outstanding protection and is easy to install due to the 2-part system.

**Mounting Procedure:**

Mount the lower profile on the hull by means of the stainless steel mounting strip. Then push the upper profil into the lower profile.

**BINO 90 Fender profile:**

Dimensions: 90x53mm (wxd)

<b>Item Code 080750</b>	Color Black	Min. order 12m
<b>Item Code 080790</b>	Stainless Steel Mounting Strip	L=2m, B=25mm
<b>Item Code 080755</b>	Plastic end cap	white

Also available (upon request) in 65mm width



allpa  
Fender Profile  
„BINO“



bumper

PVC Fender Profile "BUMPER" offers great absorption and protection and is easy to install due to the 3-part system.

**Mounting Procedure:**

Mount both outer profiles on the hull by means of the stainless steel mounting strip. Then push the middle profil in between.

**BUMPER 125 Fender profile:**

Dimensions: 125x60mm (wxd)

<b>Item Code 080700</b>	Color White	Min. order 12m
<b>Item Code 080710</b>	Color Black	Min. order 12m
<b>Item Code 080270</b>	Color Grey	Min. order 12m
<b>Item Code 080790</b>	Stainless Steel Mounting Strip	L=2m, B=25mm
<b>Item Code 080705</b>	Plastic end cap	white
<b>Item Code 080715</b>	Plastic end cap	black
<b>Item Code 080725</b>	Plastic end cap	grey

Also available (upon request) in 100, 150 & 160mm width

allpa  
Fender Profile  
„Bumper“





**"RADIAL"**  
Fender Profile

Also available in black color!



**RADIAL**  
Fender profile

Excellent protection, easy to mount PVC fender profile. Durable marine grade material, UV-resistant, colourfast. The most extraordinary feature of this patented fender profile is that it can be fitted cold in a few steps.

#### **MOUNTING PROCEDURE:**

##### **1. HARD PROFILE INSTALLATION**

Drill and fasten using flat screws placed in the median section as shown in the picture.

RADIAL 80 requires two additional sets of screw =>

##### **2. SOFT PROFILE FITTING**

Bending the profile all backwards as shown in the picture will completely open the internal holding section and it can be easily engaged to the hard rail.

RADIAL 40 & 52 can be fitted cold.

RADIAL 80 requires an ambient temperature of 40°C.

##### **3. THE RADIAL FENDER PROFILE PROPERLY INSTALLED AS SHOWN IN LAST PICTURE**

The rigid mounting strip tracks are available in 2m length.

The fender profile is available in 16mm length.

Colours: light grey (standard) and black.

Available in 3 sizes: 40mm, 52mm &, 80mm.



##### **1. HARD PROFILE INSTALLATION**



##### **2. SOFT PROFILE FITTING**



##### **3. THE RADIAL FENDER PROFILE PROPERLY INSTALLED AS SHOWN IN LAST PICTURE**

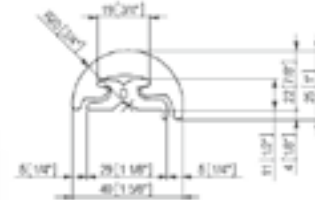

### RADIAL 40 (H=25mm)

Description	Item Code	Min. Order	Width	Min. bending radius/Color
Rigid track 2m	080252	1	29mm	60mm
Fender profile	080250	16m	40mm	Light grey
Fender profile	080254	16m	40mm	Black
Fender profile	080249	16m	40mm	White
Plastic End-Cap	080306	1		Light grey
Plastic End-Cap	080302	1		Black
Plastic End-Cap	080316	1		White
INOX End-Cap (per Unit)	080340	1		Option
INOX Top-Cap	080346	1		Option

### RADIAL 52 (H=39mm)

Description	Item Code	Min. Order	Width	Min. bending radius/Color
Rigid track 2m	080261	1	42mm	70mm (RAD52 & RAD65)
Fender profile	080260	16m	52mm	Light grey
Fender profile	080262	16m	52mm	Black
Plastic End-Cap	080307	1		Light grey
Plastic End-Cap	080310	1		Black
INOX End-Cap (per Unit)	080342	1		Option
INOX Top-Cap	080348	1		Option

### RADIAL 65 (H=39mm)

Omschrijving	Item Code	Min. Order	Width	Min. bending radius/Color
Rigid track 2m	080261	1	42mm	70mm (RAD52 & RAD65)
Fender profile	080270	16m	65mm	Light grey
Fender profile	080272	16m	65mm	Black
Plastic End-Cap	080307	1		Light grey
Plastic End-Cap	080310	1		Black
INOX End-Cap (per Unit)	080343	1		Option
INOX Top-Cap	080387	1		Option

### RADIAL 80 (H=52mm)

Description	Item Code	Min. Order	Width	Min. bending radius/Color
Rigid track 2m	080281	1	62mm	100mm
Fender profile	080280	16m	80mm	Light grey
Fender profile	080282	16m	80mm	Black
INOX End-Cap kit L+R	080344	1		
INOX Top-Cap	080350	1		

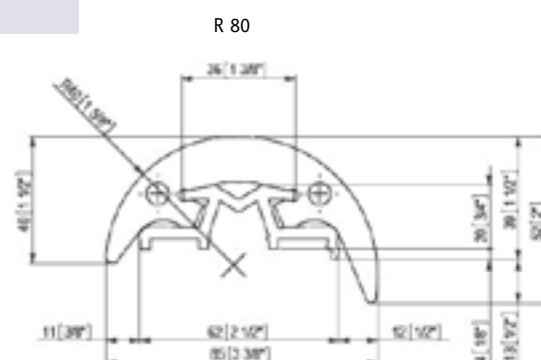
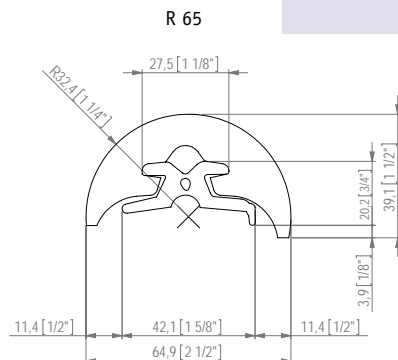
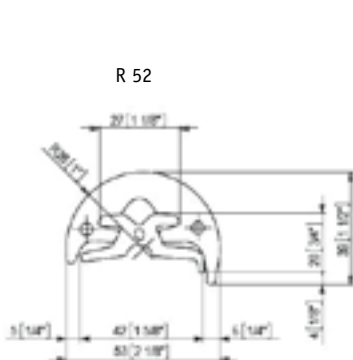

Other Lengths upon Request

sphaera



### "Sphaera" Stainless Steel Fender Profile

**Sphaera** is a revolutionary fender profile, made of stainless steel co-extruded with rigid and shockproof vinyl chloride. Thanks to the innovative structural system, Sphaera is the first fender profile which combines high technical performance, with good quality and aesthetical finishes.

The filling of vinyl chloride gives the stainless steel profile a high level of adaptability to the shapes of the hull, avoiding bend deformation and allowing very difficult bending operations.



Also available in grey or black color!  
Also available in widths of 50 & 65mm in  
grey and black color!







“Sphaera”  
Stainless Steel  
Fender Profile

**Sphaera 25mm**

Ref. Profiles:	Definition	Minimum order
	<b>Sphaera 25mm</b>	
1	<b>Item Code 080360</b> PVC base, high, white	12m
	<b>Item Code 080361</b> PVC base, high, black	12m
2	<b>Item Code 080362</b> PVC base, low	12m
3	<b>Item Code 080364</b> Stainless Steel profile Sphaera 25	12m, in lengtes van 3m

**End- and top caps:**

	Definition	Minimum order
	<b>Sphaera 25mm</b>	
A	<b>Item Code 080366</b> Stainless steel top cap (required for each 3m bar)	
D	<b>Item Code 080370</b> Pair of stainless steel end caps, consisting of “B+C”, for high base (ref.1)	
C	<b>Item Code 080369</b> Stainless steel end cap for low base. Also if no base is used (ref.2) (per Unit)	

**Sphaera 35mm**

Ref. Profiles:	Definition	Minimum order
	<b>Sphaera 35mm</b>	
1	<b>Item Code 080320</b> PVC base, high, white	12m
	<b>Item Code 080321</b> PVC base, high, black	12m
2	<b>Item Code 080322</b> PVC base, low, white	12m
3	<b>Item Code 080324</b> Stainless Steel profile Sphaera 35	12m, in lengtes van 3m

**End- and top caps:**

	Definition	Minimum order
	<b>Sphaera 35mm</b>	
A	<b>Item Code 080326</b> Stainless steel top cap (required for each 3m bar)	
D	<b>Item Code 080329</b> Pair of stainless steel end caps, consisting of “B+C”, for high base (ref.1)	
C	<b>Item Code 080330</b> Stainless steel end cap for low base. Also if no base is used (ref.2) (per Unit)	

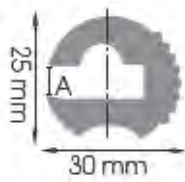

L28  
A = 8mm

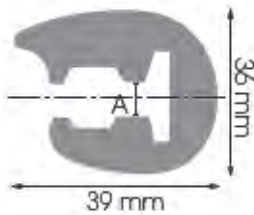

L35  
A = 8mm



## „L-Serie“ Fender Profile

PVC Finishing profile for direct mount on the joint between deck and hull. Profile L28 is direct mount. Profile L35 must be mounted with a T-mount strip. Easy mounting by heating the profile.

Description	Item Code	Min. order	Dimensions	Color
Profile L28	<b>080400</b>	50m	25x30mm (wxd)	White
Profile L35	<b>080405</b>	24m	36x39mm (wxd)	White
End Cap L28	<b>080410</b>	per Unit		
End Cap L35	<b>080420</b>	per Unit		
Joint L28/L35	<b>080425</b>	per Unit		
T-Mount strip L35	<b>080435</b>	2m		White





Easy mount PVC profile.  
Highly resistant against impact and abrasion and will not mark.

**Also available in white color**

Description	Item Code	Min. order	Dimensions	Color
Dock 60	<b>080460</b>	16m	60x40mm (wxd)	Black
Dock 90	<b>080490</b>	16m	90x60mm (wxd)	Black

### „DOCK“ Fender Profile

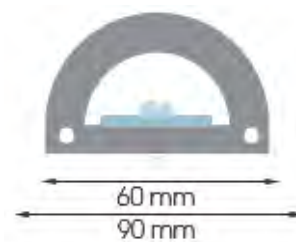



Inline- blower 12V  
Capacity **90-120m<sup>3</sup>/h**

	A	B	C	
<b>Item Code 078650</b>	76	127	108	(mm)

### Extraction Ventilator for Engine Rooms



Inline-blower 12V-4,5A  
Capacity **207m<sup>3</sup>/h**  
Dims. 212 x 135 (103) x 108mm lxxwxh  
Ø75mm Hose connection

**Item Code 078250**

### Extraction Ventilator for Engine Rooms



Blower 12 or 24V  
Capacity **280m<sup>3</sup>/h**  
Ignition protected  
Dims. 200 x 165 x 195mm  
Hose Connections: Inlet Ø75mm, Outlet Ø72mm  
R.I.N.A. – Certified according to ISO8846 en EN55814

**Item Code 001212** Blower 12V (3,9A)

**Item Code 001224** Blower 24V (2,5A)

### Extraction Ventilator for Engine Rooms



#### Flange Mount

Item Code	Description	Capacity
<b>66-80-47417-01</b>	AirV 4-550 12V (11,5A)	<b>550m<sup>3</sup>/h</b>
<b>66-80-47417-02</b>	AirV 4-550 24V ( 7,0A)	<b>550m<sup>3</sup>/h</b>

Ø110mm inlet, Ø103mm outlet. Dims.: 290x257x150mm (hxwxl)

<b>66-80-47418-01</b>	AirV 4-750 12V (19,0A)	<b>750m<sup>3</sup>/h</b>
<b>66-80-47418-02</b>	AirV 4-750 24V (11,0A)	<b>750m<sup>3</sup>/h</b>

Ø150mm inlet, Ø103mm outlet. Dims.: 290x257x150mm (hxwxl)

#### Flex Mount

Item Code	Description	Capacity
<b>66-80-47420-01</b>	AirV 4-550 12V (11,5A)	<b>550m<sup>3</sup>/h</b>
<b>66-80-47420-02</b>	AirV 4-550 24V ( 7,0A)	<b>550m<sup>3</sup>/h</b>

Ø110mm inlet, Ø103mm outlet. Dims.: 290x257x150mm (hxwxl)

<b>66-80-47421-01</b>	AirV 4-750 12V (19,0A)	<b>750m<sup>3</sup>/h</b>
<b>66-80-47421-02</b>	AirV 4-750 24V (11,0A)	<b>750m<sup>3</sup>/h</b>

Ø150mm inlet, Ø103mm outlet. Dims.: 290x257x150mm (hxwxl)

#### CE marked according to following standards:

- \* ISO 9097:1991 Marine (Small craft, Electrical fans)
- \* ISO 8846:1990 (Ignition protection)
- \* ISO 10133: 2000 (Electrical systems)
- \* EN 55014-1:2006 (2004/108EC)
- \* Complies with: N.M.M.A USCG 183.410

Extraction ventilator 12V-6A  
Capacity **750m<sup>3</sup>/h**. Ignition protected. Suitable for bulkhead mount

Dims.: Ø191mm (bulkhead side), Ø176mm, L=158mm

**Item Code 018300**

R.I.N.A.-certified according to ISO 8846 & EN 55814  
(DI-P0379Y1/001-002-003-004)

### Extraction Ventilator for Engine Rooms



### Johnson Pump®

### Extraction Ventilator for Engine Rooms



### Suitable for continuous duty





**UFO-Stainless Steel Deck Ventilator**

Very good ventilation. Absolutely spray-waterproof 100% Easy closing from inside. Provided with stainless steel fly screen. Step-on safe Very suitable for sailing yachts Incl. plastic grill to finish the interior

- Item Code 048976** Outer Ø185mm, Cut out Ø85mm
- Item Code 048977** Outer Ø240mm, Cut out Ø123mm



**MUSHROOM Stainless Steel Ventilator**

Very good Ventilation 100% Easy closing from inside. No Step Incl. stainless steel fly screen and plastic counter flange

- Item Code 048978** Outer Ø120mm, Cut out Ø85mm
- Item Code 048979** Outer Ø150mm, Cut out Ø123mm
- Item Code 048980** Outer Ø175mm, Cut out Ø150mm



**Solar Power Ventilator Stainless steel**

**Item Code L6470225** Solar Power Ventilator with built-in battery for 24h ventilation. Incl. switch. Dims. Ø216mm, cut out size Ø118mm. Built-in depth 35mm. Total height 101,6mm (2-3/4") Cap. ± 20m³/Hr.

- Item Code L6470226** Spare Battery

**GB** Charge up before use  
**D** Vor Gebrauch aufladen  
**NL** Opladen voor het gebruik



*stainless steel*  
**316**

**Stainless Steel Shell Ventilator**

Can be screwed directly on the hull or superstructure. Ideal for ventilation of engine rooms Mounting Plate provides Water Guard Dims. 126 x 143 x 47mm

- Item Code 048975** Shell Ventilator
- Item Code 048981** Mounting plate with hose connection Ø76mm



**Ventilation Hose**

Ventilation hose (Price per roll)

- Item Code 817606** Ø 76mm, L= 6m
- Item Code 180300** Ø 82mm, L= 10m
- Item Code 180310** Ø102mm, L= 10m
- Item Code 180315** Ø152mm, L= 10m

<b>Item Code 078140</b>	127 x 115mm (L x B)
<b>Item Code 078141</b>	230 x 115mm (L x B)
<b>Item Code 078142</b>	Outer Ø 102mm Hole Pitch Ø92mm

**Stainless Steel  
"LOUVRES"**

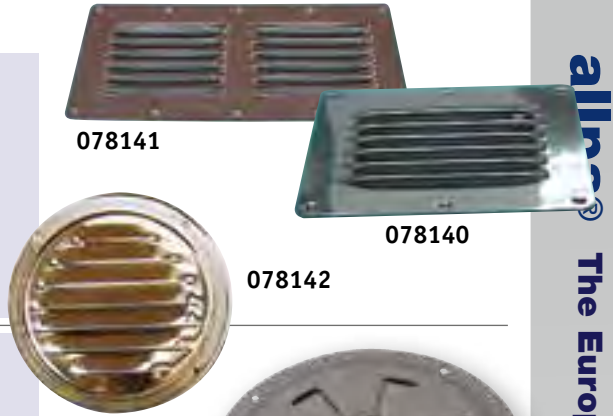

<b>Item Code 098145</b>	D = 102mm
<b>Item Code 098146</b>	D = 127mm

**Stainless Steel  
Butterfly Vent**

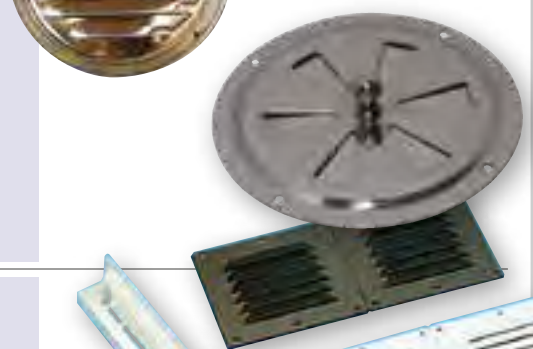

<b>Item Code 006750/B</b>	255x115mm, black
<b>Item Code 006750/W</b>	255x115mm, white
<b>Item Code 006755</b>	420x120mm, Built-in type with water guard

**Plastic  
"LOUVRES"**

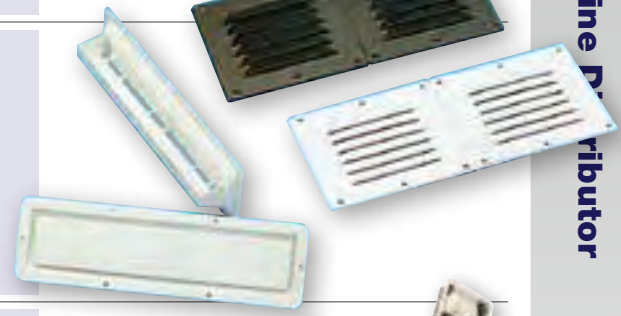

	Cut out sizes (LxWxH)	Outer sizes (LxW)
<b>Item Code 078130</b>	240 x 90 x 29mm	265 x 112mm
<b>Item Code 078131</b>	305 x 87 x 27mm	328 x 112mm
<b>Item Code 078132</b>	505 x 89 x 27mm	528 x 112mm

**Stainless Steel  
„LOUVRES“**



<b>Item Code 078147</b>	80x80mm, white
<b>Item Code 078148</b>	80x80mm, black
<b>Item Code 078145</b>	80x80mm, with hose connection 66mm. White
<b>Item Code 078146</b>	80x80mm, with hose connection 66mm. Black

**Plastic Grills**



<b>Item Code 078120</b>	55 x 53 x 22mm (LxBxH)
<b>Item Code 078121</b>	40 x 44 x 16mm (LxBxH)
<b>Item Code 078123</b>	118 x 120 x 45mm (LxBxH)

**Stainless Steel  
Midjet Ventilators**



Very fine cast (by lost wax method) ventilator  
Oval shaped model. Inside white coated  
Dims. A= 101 B= 254 C= 128mm

<b>Item Code 078127</b>	Cowl Ventilator This model comes complete with s/s 4" male deck ring with lock cover
-------------------------	--

**Stainless Steel  
Cowl Ventilators**





**Stainless Steel Bathing Ladder**

*stainless steel*  
**316**

**Item Code 110046**

Ladder with 3 wooden steps  
 Dims. unfolded 860 x 270mm  
 Dims. folded 600 x 270mm  
 Depth transom support 170mm  
 Min transom weight 440mm  
 Ø Tube = 20mm

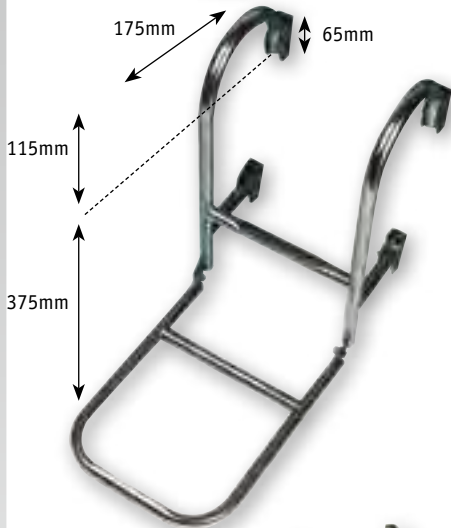

**Stainless Steel Bathing Ladder Deck mount**

*stainless steel*  
**316**

**Item Code 110040**

3-Steps folding ladder with fixed ransom supports  
 Dims. 260 x 780mm. Ø Tube = 20mm, radius 85mm  
 Min. transom height 380mm

**Item Code 110041**

4-Steps folding ladder with fixed ransom supports  
 Dims. 260 x 1010mm. Ø Tube = 20mm, radius 85mm  
 Min. transom height 380mm



**Stainless Steel Bathing Ladder**

*stainless steel*  
**316**

**Item Code 110043 3-Steps**

Dims. unfolded 260 x 600mm. Ø Tube = 20mm  
 Min. transom height 290mm

**Item Code 110044 4-Steps**

Dims. unfolded 260 x 830mm. Ø Tube = 20mm  
 Min. transom height 390mm

**Item Code 110045 5-Steps**

Dims. unfolded 260 x 1040mm. Ø Tube = 20mm  
 Min. transom height 550mm

**Item Code 150310** Single Plastic Clip

**Item Code 048013** Single Rubber Cap (1x)



**Stainless Steel Bathing Ladder**

*stainless steel*  
**316**

Folding ladder with adjustable transom supports

**Item Code C7074 3-Steps**

Dims. unfolded 260 x 700mm. Ø Tube = 22mm  
 Min. transom height 420mm

**Item Code C7075 4-Steps**

Dims. unfolded 260 x 1030mm. Ø Tube = 20mm  
 Min. transom height 440mm

**Item Code 048010** Single Rubber Cap for transom supports, internal Ø25mm



stainless steel

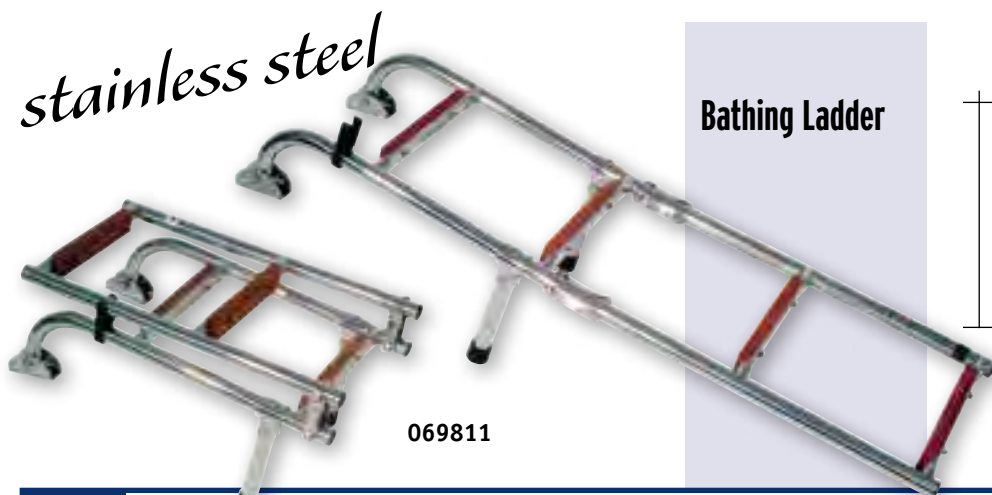

Bathing Ladder



069811

069800

Item Code	Steps	Number of steps	Width (mm) center-center	Length (mm) folded	Length (mm) unfolded	Support depth (mm)	Ø Tube (mm)	Size-A (mm) center-center
069800	Stainless Steel	1 + 2	200	320	600	100	22	200
069801	Stainless Steel	2 + 2	235	449	880	100	22	340
069802	Stainless Steel	3 + 2	235	729	1085	100	22	650
069803	Stainless Steel	2 + 3	254	607	1085	100	22	400
069804	Stainless Steel	3 + 3	254	729	1315	100	22	650
069806	S/S <b>NEW</b>	1 + 2	235	320	600	100	22	
069810	S/S + Teak	1 + 2	200	320	600	100	22	200
069811	S/S + Teak	2 + 2	235	449	880	100	22	340
069813	S/S + Teak	2 + 3	254	607	1085	100	22	400

For all bathing ladders  
For all bathing ladders  
For all bathing ladders

**Item Code 069830** Spare plastic clamp, black, for Ø20-22mm

**Item Code 069832** Spare plastic clamp, white, for Ø20-22mm

**Item Code 069839** Spare plastic clamp, white, for Ø25mm

**Item Code 069831** Set stainless steel distance holders incl. mounting brackets

**Item Code 495005** Open T-Fitting 90°, for Tube Ø22mm, with plastic insert.

Open T-Fitting  
Stainless Steel



**Item Code 495009** L=45mm, for Tube Ø22mm.

Windscreen Bracket  
Stainless Steel



Wooden ladder with safety hooks and Anti-Sliding steps.  
Hardware in chromium plated brass. Folding model.

Wooden ladder

**Item Code S1400004** Wooden ladder 2+2 steps L = 900

**Item Code S1400006** Wooden ladder 3+3 steps L = 1300

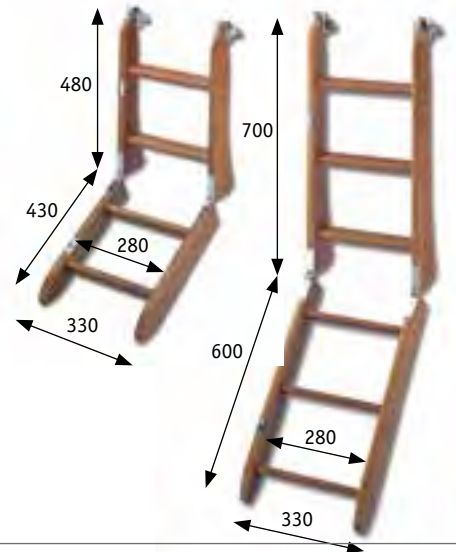

Fastening for Wooden ladder

**Item Code S2100180** Hook without Lock-in (105x19x4/23mm)

**Item Code S2100100** Hook with Lock-in  
(122x32x42mm closed)

**Item Code S2100090** Plate for hook (85x29x3/13mm)

**Item Code S2100250** Hinge (72,5/145x20x3 open/closed)

Fastening



stainless steel  
**316**

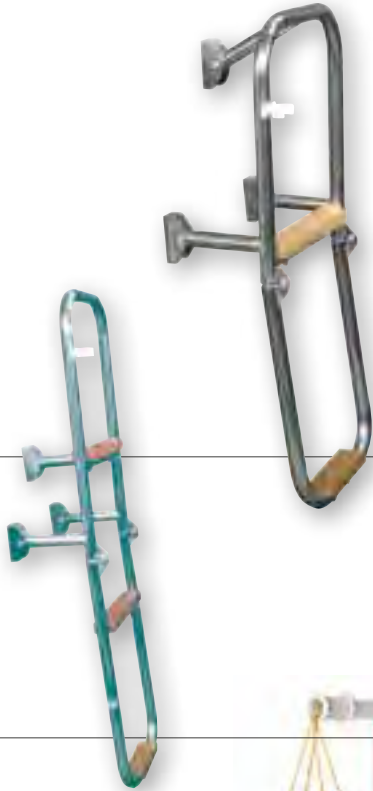

### Stainless Steel Bathing Ladder

**Item Code 110053**

Folding with 2 wooden steps  
Dims. unfolded 658 x 240mm.  
Ø Tube= 20mm. Dims. folded 345 x 240mm  
Depth transom support 145mm  
Min. Transom height 300mm

stainless steel  
**316**



### Flushmount Safety Rope Ladder

**Item Code 110054**

Folding with 3 wooden steps  
Dims. unfolded 930 x 240mm.  
Ø Tube=20mm Dims. folded 405 x 240mm  
Depth transom support 160mm  
Min. transom height 250mm

**Item Code 1651558** Flushmount Safety Rope Ladder  
Allpa Safety Roper ladder with 3 steps. Helps any crew member get back on board easily without external help. Ladder is stored in a polyamide tube.  
Overall dimensions:  
L=235mm Ø48mm



### Mast Step

Folding step for mast mounting of glass filled nylon.  
Very solid, rattle-free and UV-resistant.  
Safe working load 140kg. Light weighting: 0.168kg.  
Available in black, white and grey.

- Item Code M001** Mast Step, black
- Item Code M002** Mast Step, white
- Item Code M003** Mast Step, grey

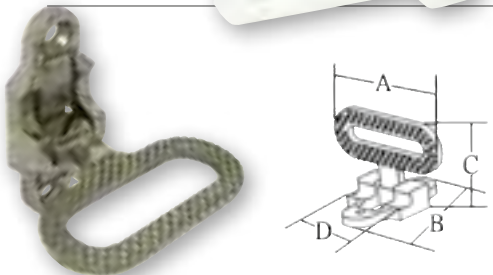

### Stainless Steel Mast Step Folding

**Item Code 078795**

A = 111mm, B = 126mm,  
C = 100mm, D = 48mm  
Safe working load: 180kg  
Mounting hole pitch: 98mm.  
Hole Ø 8mm. Casted SS-316

### Stainless Steel Fastening Kit for Bathing Ladders

**Item Code 494010**

Quick Connect kit for temporarily hooking on a ladder  
Max Ø25mm.  
S/S 304



Telescopic bathing ladder for mounting on transom platform. With handles. Slides in and folds up.

- Item Code 078802** 2+1 Oval steps with black plastic.  
Length: out 605mm, in 354mm  
Max. width: 358mm. Ø Tube: 19/25mm
- Item Code 078803** 3+1 Oval steps with black plastic.  
Length: out 880mm, in 374mm  
Max. width: 358mm. Ø Tube: 19/25/32mm
- Item Code 078804** 4+1 Oval steps with black plastic.  
Length: out 1156mm, in 394mm  
Max. width: 358mm. Ø Tube: 19/25/32/38mm

### Telescopic Bathing Ladder "Prince"



Robust and high quality telescopic bathing ladder. With handles. Slides in and folds up.

- Item Code 269800** 3+1 Oval steps with black plastic.  
Length: out 880mm, in 380mm  
Max. width: 300mm. Ø Tube: 19/25/32mm

### Telescopic Bathing Ladder Cruiser

stainless steel 316



- Item Code 110047** 5-Steps folding with fixed supports  
Dims. 300x1400mm, Ø25mm, radius 165mm  
Min. transom height 500mm

- Item Code 110048** 6-Steps folding with fixed supports  
Dims. 300x1620mm, Ø25mm, radius 165mm  
Min. transom height 600mm

### Stainless Steel Bathing Ladder

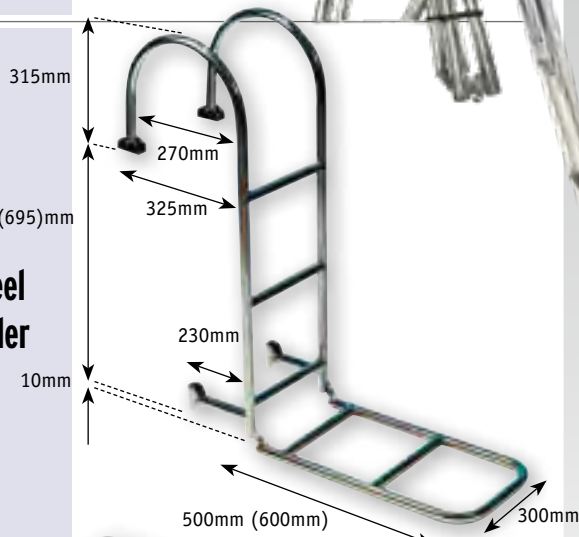

- Item Code 029180** 3 + 1 = 4 Steps. Dims. 310 x 650mm
- Item Code 029190** 4 + 1 = 5 Steps. Dims. 310 x 900mm
- Item Code 029200** 5 + 1 = 6 Steps. Dims. 310 x 1200mm

Tube Ø25mm. Mounting with 4 studs.  
Extra, separate step for mounting above the ladder, with clip to hold swing part when folded.  
Plastic protection on tubing where it hits transom edge.

- Item Code G029100** Extra Single Step

### Stainless Steel Bathing Ladder

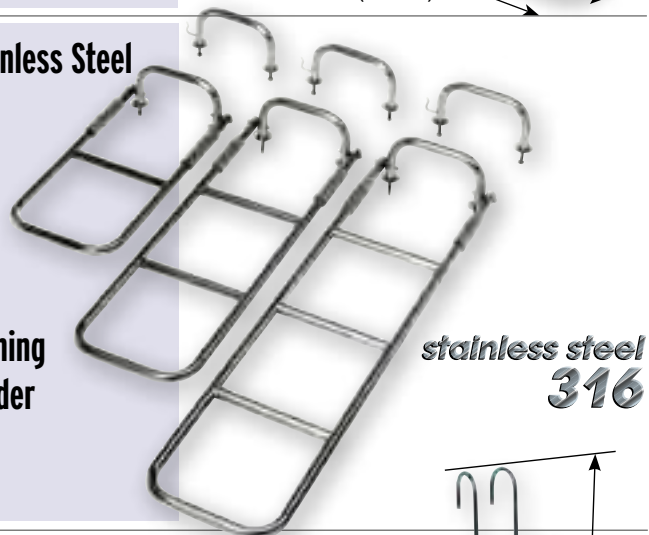

Hook length 260mm, Bow Support length 520mm

- Item Code 110052** 3-Steps, folding bow ladder  
Dims. 300 x 900mm, Ø25mm,  
Size-A = 850mm
- Item Code 110051** 4-Steps, folding bow ladder  
Dims. 300 x 1180mm, Ø25mm,  
Size-A = 850mm
- Item Code 110050** 7-Steps, folding bow ladder  
Dims. 300 x 1780mm, Ø25mm,  
Size-A = 950mm

### Stainless Steel Bow Ladder

stainless steel 316



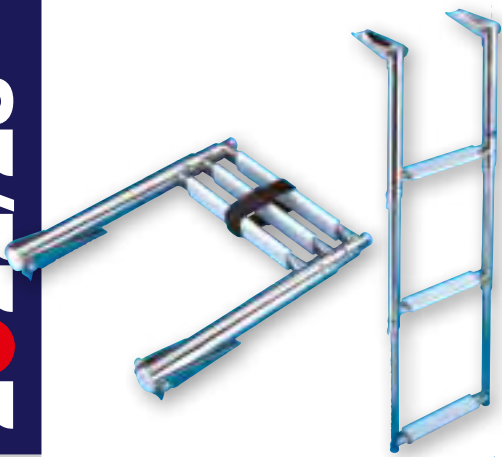

**Stainless Steel Telescopic Bathing Ladder**

**Item Code S3101003**

3 Steps ladder  
For mounting on a transom platform  
Dims. closed in 390 x 285mm. Ø Tube = 32mm (max)  
Dims. extended out 880 x 285mm



**Stainless Steel Telescopic Bathing Ladder**

Code	Steps	A	A1	B	C	Ø tube (mm)
078800	3	889	380	254	152	32max
078801	4	1157	400	254	152	38max

Size A1: Length retracted  
Size B: Center to center

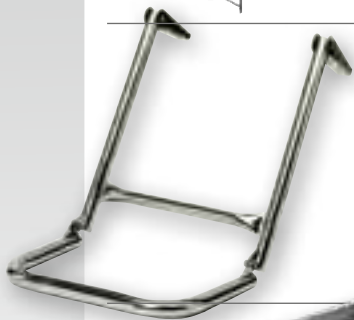

**Stainless Steel Bathing Ladder**

*stainless steel*  
**316**

**Item Code 048200**

2 Steps, folding  
Deck or transom platform mount  
Tube Ø25mm. Dims. 370 x 600mm



**Stainless Steel Hinge for Bathing Ladder**

**Item Code S3030001**

Set of 2 pieces  
For transom platform mounting  
Max. Tube Ø32mm  
Dims. 180x40mm (lxw)

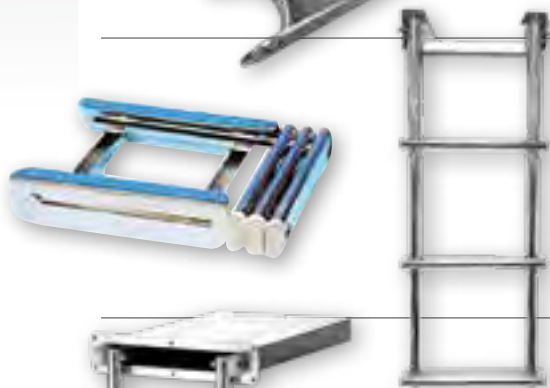

**Stainless Steel Hinge for Bathing Ladder**

**Item Code 494020**

3 Steps ladder  
For mounting under a transom platform  
Dims. closed in 345 x 280mm. Ø Tube = 30mm (max)  
Dims. extended 690 x 280mm.



**Stainless Steel Telescopic Bathing Ladder**

Stainless Steel A316 Telescopic Close-In Bathing Ladders. These ladders are stowed away in a stainless steel box. This box may be built in the boat hull. Steps have plastic anti-slip covering.  
Dims. box: 335 x 490 x 50mm. Box flange: 392 x 80mm.

- Item Code 024340** 3-Step ladder - 850 x 290mm (lxw)
- Item Code 024340** 4-Step ladder - 1155 x 290mm (lxw)

- Item Code S0125003** 3 Plastic steps, L = 86cm
- Item Code S0125004** 4 Plastic steps, L = 116cm
- Item Code S0125005** 5 Plastic steps, L = 145cm

These ladders come with self orienting, Folding and adjustable transom supports. Tube Ø25mm. The 5-step ladder comes with 2 pairs of transom supports.

- Item Code S2000060**  
Spare transom support kit

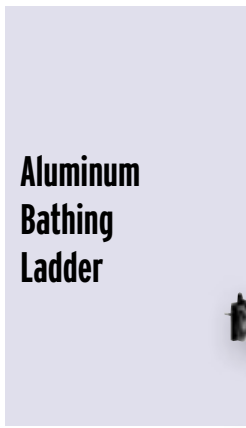

**Aluminum Bathing Ladder**



- Item Code S1123003**  
3 Steps, folding. Tube Ø25mm  
Length: 740mm, width 220mm



**Stainless Steel Bathing Ladder**

- Item Code S1130003**  
3-Steps, folding. Ø Tube = 25mm  
Dims. unfolded 930 x 300mm



**Aluminum Bathing Ladders for Inflatable Boats**

- Item Code S1130004**  
4-Steps, folding. Ø Tube = 25mm  
Dims. unfolded 1130 x 300mm

- Item Code 269055**  
Stainless Steel Folding bathing ladder  
L max. = 95cm, L min. = 50cm, width 27cm, 3-Steps. Ø25mm



**Stainless Steel Folding bathing ladder**

- Item Code 269060**  
Telescopic dinghy bathing ladder Stainless Steel  
L max. = 125cm, L min. = 75cm, width 29cm, 4-Steps Ø25mm



**Telescopic dinghy bathing ladder**

- Item Code S1509003** 3 Steps of Lexan®  
Length 87cm, width 30cm

- Item Code S1509004** 4 Steps of Lexan®  
Length 106cm, width 30cm

- Item Code S1509005** 5 Steps of Lexan®  
Length 146cm, width 30cm

Easy twist fold for very little storage space



**Rope-Ladder**



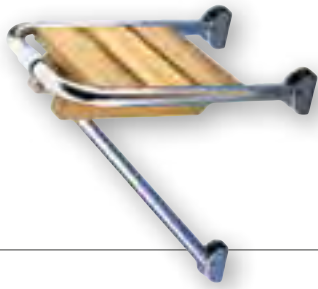

### Mini Transom Platform

**Item Code S1900027**

Mini Transom Platform Stainless Steel with Teak Wood  
 Dims. 270 x 360mm (W x D)  
 Tube Ø25mm



### Transom Platform

Transom platform complete with mounting material all stainless steel. Tube Ø25mm

**Item Code 494050** Dims.1260x550mm

**Item Code 494051** Dims.1500x550mm

**Item Code 494152** Dims.1750x550mm

**Item Code 494053** Dims.2000x550mm

These platforms may be combined with bathing ladder code S1922623 or 494060



### Bathing Ladder Stainless Steel

**Item Code 494060**

Stainless steel folding bathing ladder with 3 wooden steps. Tube Ø25mm. Complete with mounting materials  
 Dims. 270x680x380mm (w x lmax x lmin) Lower width 245mm



### Bathing Ladder Stainless Steel

**Item Code S1931003**

Stainless steel folding bathing ladder with 3 wooden steps and grab rail. Tube Ø25mm.  
 Dims 320x1020x580mm (w x l-max x l-min)  
 Inside width steps: 200mm

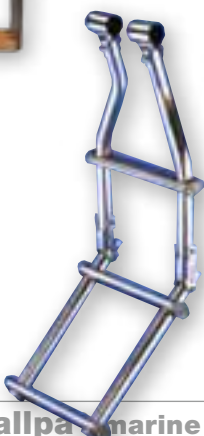

### Stainless Steel Bathing Ladder

**Item Code S1922623**

3 Steps, folding bathing ladder.  
 For mounting on transom platform S1960027  
 Width 220mm. Tube Ø25mm

Control by hand with ratcheted winch.  
The arm has an extra fastening point for the dinghy.  
Complete with rope and block.

**Item Code 048900** Max. load per Pair: 120kg.

**Price per Piece!**

Base dims. 100 x 150mm

A = 830mm, B = 650mm, C = 1200mm

**Item Code 048902** Max. load per Pair: 200kg.

**Price per Piece!**

Base dims. 120 x 200mm

A = 1050mm, B = 1000mm, C = 1520mm

**Item Code 048904** Max. Load per Pair: 300kg.

**Price per Piece!**

Base dims. 180 x 240mm

A = 1160mm, B = 1200mm, C = 1750mm

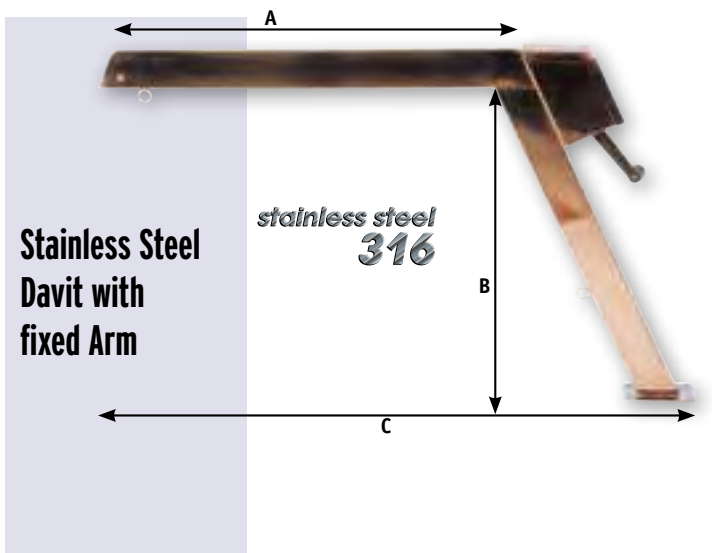

Control by hand with ratcheted winch.

The position of rope exit will not change while extending the telescopic arm. The dinghy must always be connected to the fixed part of the davit arm! The connection point on the telescopic part of the arm is used to tighten the dinghy to the davit, thus eliminating swinging.

Supplied complete with rope and block.

**Item Code 048901** Max. load per Pair: 120kg.

**Price per Piece!**

Base dims. 100 x 150mm

A<sup>min</sup> = 1080mm, A<sup>max</sup> = 1370, B = 720mm, C = 1450mm

**Item Code 048903** Max. load per Pair: 200kg.

**Price per Piece!**

Base dims. 120 x 200mm

A<sup>min</sup> = 1220mm, A<sup>max</sup> = 1800, B = 930mm, C = 1610mm

**Item Code 048905** Max. load per Pair: 300kg.

**Price per Piece!**

Base dims. 180 x 240mm

A<sup>min</sup> = 1340mm, A<sup>max</sup> = 2170, B = 1210mm, C = 1930mm

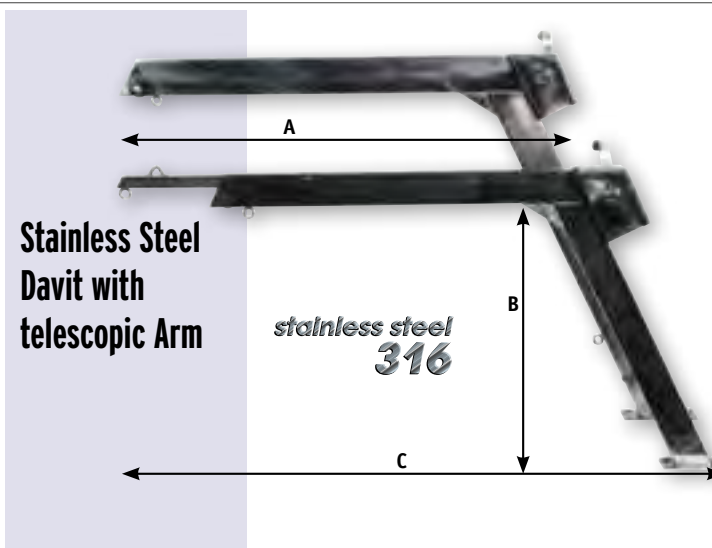

**Item Code 01740120** Pair of Davits with Aluminum Base.

Supplied complete with line and blocks. Tube Ø40mm.

A = 700mm, B = 850mm Max. Load per Pair 120kg.

**Price per Pair!**

Ø Base = 185mm. Height base = 125mm.

Mounting holes Ø12,5mm.

Mounting bolts Ø12mm.

Hole pitch Ø142mm (4x90°).





Perfect option when the use of a stern gangway/ passerelle is not possible.

Simple, safe, port or starboard boarding solution.

**Characteristics:**

- Constructed in lightweight anodised Aluminium and Stainless Steel for harsh marine environments.
- Patented Quick Release System.
- Features "No pinch" Design.
- 4 x 316 Stainless steel casters- allowing free movement with tide.
- Single handrail (additional handrail available)
- Unique storable design – folds for easy storage
- Comes standard with non-slip steps. Flexiteak is an option.

Supplied with 1 pair of hull brackets, 1 pair quick release brackets



Item Code	No. of Steps	Stowed Size	Deck to Dock	Weight	A	B	C	D
084854	4	110x60x8	81cm	14kg	88cm	33cm	53cm	60cm
084855	5	135x60x8	100cm	18kg	115cm	60cm	53cm	60cm
084856	6	163x60x8	122cm	23kg	142cm	86cm	53cm	60cm
084857	7	188x60x8	142cm	28kg	168cm	113cm	53cm	60cm
084858	8	216x60x8	163cm	32kg	195cm	140cm	53cm	60cm
084859	9	240x60x8	183cm	36kg	221cm	151cm	53cm	60cm

**Self levelling boarding stairs**

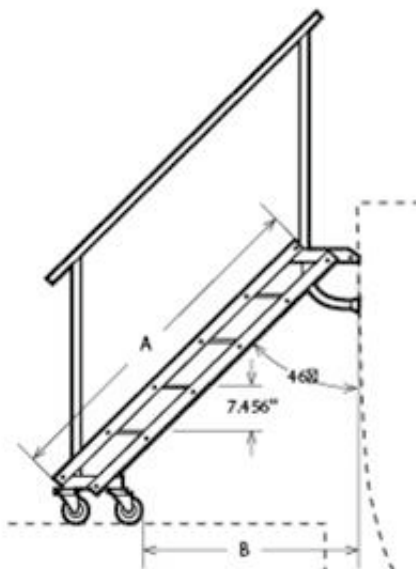

- Item Code 084860** Additional handrail
- Item Code 084861** 1 pair of Hull brackets
- Item Code 084862** 1 pair of quick release brackets
- Item Code 084863** Storage bag for item code 084854 till 084856
- Item Code 084864** Storage bag for item code 084857 till 084859
- Item Code 084865** Stowage kit

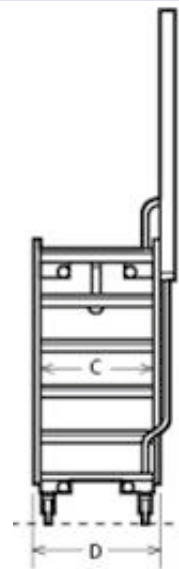



Aluminum with Marine grade Wood  
Supplied with wheels and pivot pin and stanchion bases  
(but without stanchions)

**Item Code S6153200** Length 200cm, Width 36cm  
Weight 10kg

**Item Code S6153260** Length 270cm, Width 36cm  
Weight 18kg

**Item Code S1825070** Kit of 2 aluminum stanchions  
with rope. Weight 0.6kg

Pivot pin Ø25mm  
Pivot pin mounting hole Ø40mm

### Folding Gangway

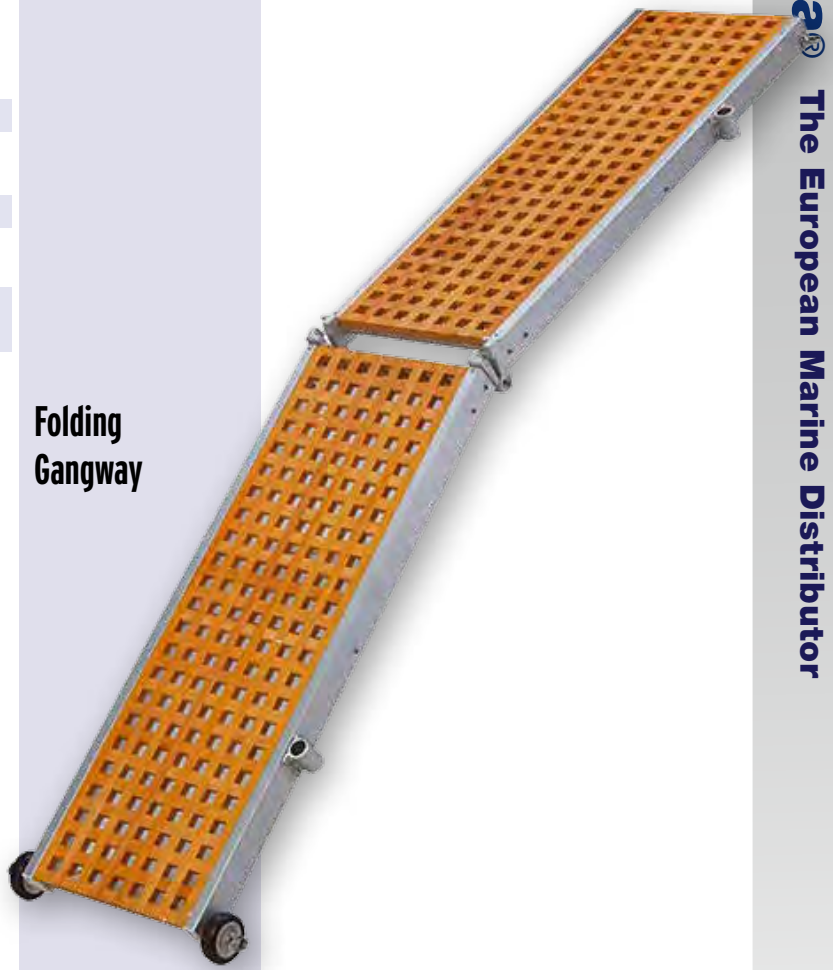

Width 37cm  
Supplied with wheels and pivot pin and stanchion bases  
(but without stanchions)

**Item Code S6331230** 2300 x 360 x 75, Weight 10kg

**Item Code S6331260** 2600 x 360 x 75, Weight 18kg

**Item Code S1825070** Kit of 2 aluminum stanchions  
with rope. Weight 0.6kg

Pivot pin Ø25mm  
Pivot pin mounting hole Ø40mm

### All Aluminum Folding Gangway





**Folding dock  
step with  
handrail**

Portable aluminium boarding step available in 3 and 4 stairs. The stairs are equipped with a non-skid cover. The dock step are perfect for boat shows, in your showroom and for easy boarding in the harbour. The dock step is fully retractable and is maximum 10 cm in height.

**Item Code 084872 2 steps with handrail**

Length: 76cm

Width: 56cm

Height: 47cm unfolded, 10cm folded

Weight: 14kg

**Item Code 084873 3 steps with handrail**

Length: 110cm

Width: 56cm

Height: 74cm unfolded, 10cm folded

Weight: 16kg

**Item Code 084874 4 steps with handrail**

Length: 150cm

Width: 56cm

Height: 87cm unfolded, 10cm folded

Weight: 18kg





# allpa

power systems



**Electrical Equipment**



### Matrix gauges for NMEA 2000® Mercury Smartcraft

**Matrix Gauges Black for Mercury SmartCraft Engines**  
White graphics on a black dial background with translucent Dial and pointer staff. LCD on Tachometer and Speedo displays all available data and alarms.

In a Matrix gauge set, the 3" tachometer is the master and connects directly to the SmartCraft data bus. All other gauges are slaves and connect to the tachometer RS-485 private bus.



Smartcraft® Tachometer w/ LCD US 7000 RPM	3"	<b>781014SDFE</b>
NMEA 2000® Tachometer w/ LCD US 7000 RPM	3"	<b>781545SDFE</b>
Speedometer w/ LCD US 90 MPH	3"	<b>781016SDFE</b>
Fuel Primary	2"	<b>781019SDFE</b>
Fuel Secondary	2"	<b>781020SDFE</b>
Voltmeter 10-16 VDC	2"	<b>781021SDFE</b>
Temperature 240°F	2"	<b>781022SDFE</b>
Water pressure 40 PSI	2"	<b>781024SDFE</b>
Oil pressure 80 PSI	2"	<b>781028SDFE</b>
Trim	2"	<b>781032SDFE</b>

#### Matrix Harness/connectors

Various harnesses are required for installations

Connects Matrix Tachometer to SmartCraft harness (30")	<b>69995E</b>
Connects Tachometer to NMEA 2000 harness (30")	<b>69996E</b>
Connects Tachometer to Speedo (48")	<b>69997E</b>
Connects any 2" gauge to another (8")	<b>69999E</b>
Terminator used when no speed is present	<b>69998E</b>



67412E

67399E

67874E

### Digital Depth Sounders

Teleflex digital depth sounder with high speed dual mount transducer allowing mounting on transom or in hull\*. Color coordinated to match popular Teleflex Marine engine gauge series. Water depth reading to 60m with instant depth readings at speeds up to 100 km/h.

Lenght cable 25 feet. (7,63m)

<b>Item Code 67412E</b>	Model Argent-Pro with stainless steel bezel
<b>Item Code 67399E</b>	Model Lido-Pro with stainless steel bezel
<b>Item Code 67874E</b>	Model Premier-Pro
<b>Item Code 67309</b>	Spare sender

\* Suitable for polyester hulls; Sender must be glued



### GPS Speedo's with Heading Display 3" Models

GPS speedometer with LCD-heading display to show course over ground

<b>Item Code 781371PDFE</b>	GPS-Speedo 30 knots, model Premier Pro, Black
<b>Item Code 781372PDFE</b>	GPS-Speedo 60 knots, model Premier Pro, Black
<b>Item Code 781387PDFE</b>	GPS-Speedo 30 knots, model Lido Pro, White with S/S bezel
<b>Item Code 781388PDFE</b>	GPS-Speedo 60 knots, model Lido Pro, White with S/S bezel
<b>Item Code 68982E</b>	GPS-Antenna*(to be ordered seperately)

\*May also be connected to an existing NMEA 0183 GPS device (NMEA 2000 in future)

**Veethree**

**FOG FREE**

Description	Range	Size	Item Codes
Tacho	0-7K	3"	65535SSF
Tacho/Hour	0-7K	3"	65545SSF
Tacho/Hour	0-4K	3"	65541SSF
Speedo kit including Pitot	0-50 knot	3"	67189SSFKE
Speedo kit including Pitot	0-75 knot	3"	70611SSFKE
Speedo head only (Pitot style)	0-50 knot	3"	67189SSF
Speedo head only (Pitot style)	0-75 knot	3"	70611SSF
Trim	Evinrude/Johnson	2"	65547SSF
Trim	Honda	2"	65549SSF
Trim	Mariner/Merc/	2"	65548SSF
Voltmeter	10v -16v	2"	65550SSF
Ammeter	0-60 amps	2"	70609SSF
Fuel	10-180 ohms	2"	67582SSF
Fuel	240-33 ohms	2"	65524SSF
Oil Pressure (0-10 Bar)	10-180 ohms	2"	67578SSF
Oil Pressure (0-10 Bar)	240-33 ohms	2"	67577SSF
Water Tank	10-180 ohms	2"	67581SSF
Water Tank	240-33 ohms	2"	67579SSF
Waste Tank	240-33 ohms	2"	70613SSF

**Argent Pro**



**FOG FREE**

Description	Range	Size	Item Codes
Tacho	0-7K	3"	84293FE
Tacho/Hour	0-7K	3"	70604FE
Tacho/Hour	0-4K	3"	84324FE
Speedo kit including Pitot	0-50 knot	3"	84576FE
Speedo kit including Pitot	0-75 knot	3"	84572FE
Speedo head only (Pitot style)	0-50 knot	3"	63045FE
Speedo head only (Pitot style)	0-75 knot	3"	63046FE
Trim	Evinrude/Johnson	2"	84740FE
Trim	Honda	2"	84746FE
Trim	Mariner/Merc/	2"	84742FE
Voltmeter	10v -16v	2"	84134FE
Ammeter	0-60 amps	2"	84710FE
Fuel	10-180 ohms	2"	84151FE
Fuel	240-33 ohms	2"	84150FE
Oil Pressure (0-10 Bar)	10-180 ohms	2"	84261FE
Oil Pressure (0-10 Bar)	240-33 ohms	2"	84264FE
Water Tank	10-180 ohms	2"	84160FE
Water Tank	240-33 ohms	2"	70605FE
Waste Tank	10-180 ohms	2"	84161FE
Waste Tank	240-33 ohms	2"	67265FE

**Premier Pro**



**NEW**

Plug and play monitors to be used for all engine types. Suitable for analog, J1939 and NMEA2000 engines. Primary display options include parameters related to engine status and alarms, as well as fuel level, rudder angle, trim, depth, speed and heading.

- Characteristics:**
- IP67
  - Plug and play
  - Button and touch models
  - NMEA 2000 Gateway allowing engine data to be broadcast to other multifunction displays

- Scope of supply:**
- protective cap
  - Harness cables for J1939, NMEA2000 and analog

**Veethree UEM**



<b>Item Code 9402</b>	Veethree UEM - R3
<b>Item Code 9410</b>	Veethree UEM - C3I
<b>Item Code 9412</b>	Veethree UEM - T5

	R3	C3I	T5
<b>Display range</b>			
Screen Size	3" LCD	3.5" LCD	5" LCD
Type	PCAP Touch	Button	PCAP Touch
Brightness	850 NIT	750 NIT	1000 NIT
<b>Data Types / Sources</b>			
J1939	✓	✓	✓
NMEA2000	✓	✓	✓
Analogue Inputs	6 +TACH	7 + TACH	1
Gateway to NMEA2000	✓	✓	✓
GPS Input	NMEA 0183	NMEA 0183	NMEA 0183
External Alarm	✓	✓	✓
<b>Diagnostics</b>			
J1939 DM1	✓	✓	✓
J1939 DM2	✓	✓	✓
CAN Logger	✓	✓	✓
CAN Viewer	✓	✓	✓
<b>Display / Electrical</b>			
Power Requirements	10-32V	10-32V	8-32V
<b>Connection</b>			
Deutsch Ports	2 x 12 pin	2 x 12 pin	-
M12 Ports	-	-	5
USB Ports	1 x Type A	1 x Type A	1 x Type A
<b>Communications</b>			
CAN Bus Ports	1	2	2
<b>Kit Part Numbers</b>			
Universal* (J1939, NMEA2000 and Analogue)	9402	9410	9412

For more information, please contact the sales team.

12-channel digital switch module with an (optional) Touchscreen display.  
 These 12 channels are completely configurable.  
 Features include: switch type, icon selection, and fuse rating.

The VeeConnect ECU is fully programmable and operable via the T5 screen.

**Item Code 71870E Standard VeeConnect ECU**

**Scope of supply:**  
 Electronic circuit breaker unit (ECBU) and installation components

**Optional:**

**Item Code 71871E** Veeconnect T5" Switch Display Kit touchscreen

**Item Code 70846** T5 Suncover

**Item Code 71818E** H1 interface module.  
 Eases switching to a compatible MFD display



VeeConnect

**NEW**

For more information, please contact the sales team.

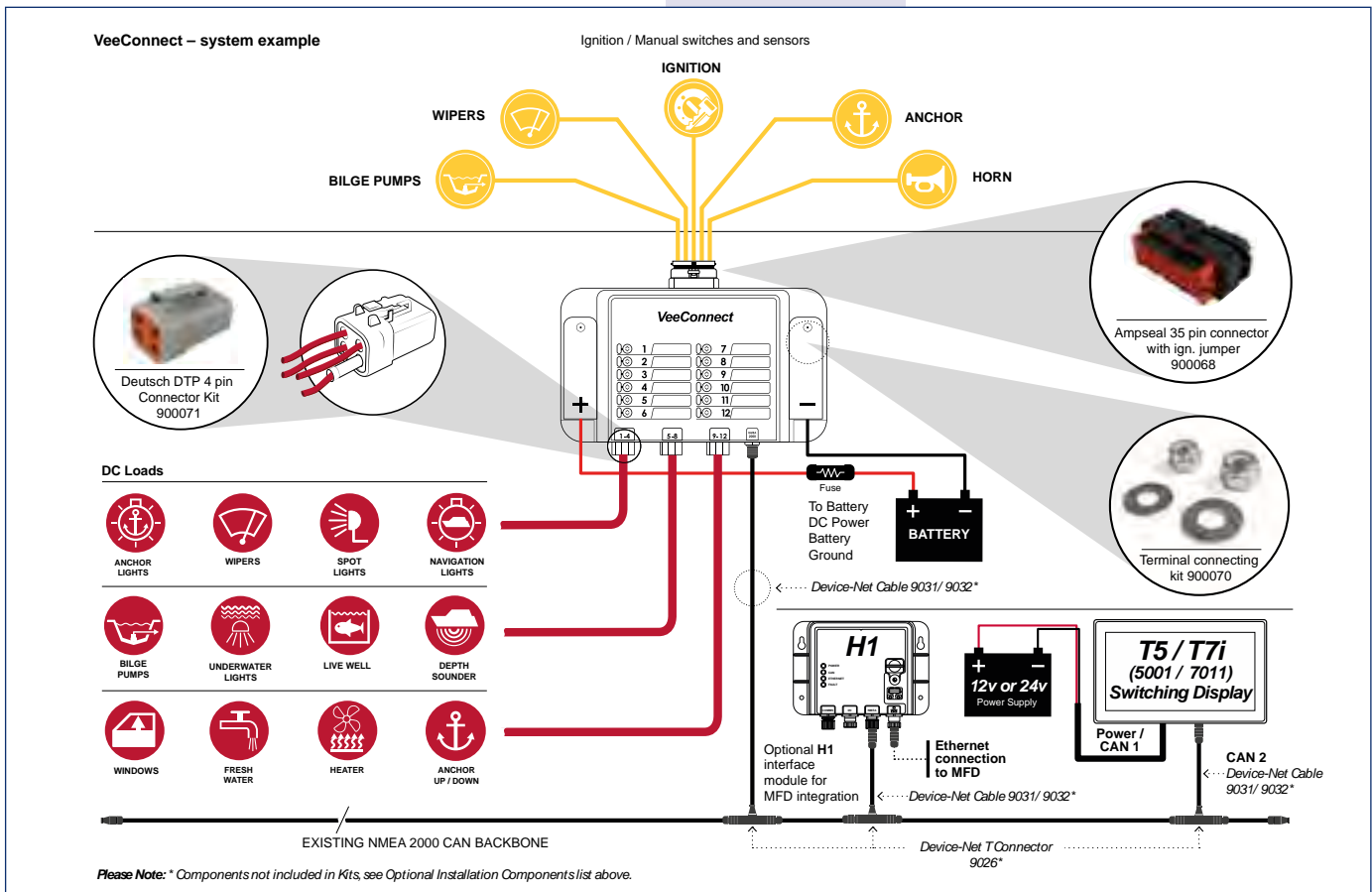

**Dimensions:**

All 2" instruments =&gt; 2,13/2,22" =&gt; cut out 54/55mm

All 3" instruments =&gt; 3,41/3,44" =&gt; cut out 86/87mm

Hour counter =&gt; 2,00/2,06" =&gt; cut out 51/52mm

**Premier Pro  
Fog Resistant**
**Lido Pro  
Fog Resistant**

Fuel Gauge 240-30 Ω (SW)	2"	84150FE	2"	59655F
Fuel Gauge 10-180 Ω (VDO)	2"	84151FE	2"	65240F
Hour meter 10,000hrs	2"	84760FE	2"	59416F
Oil Pressure Gauge (SW) 0-80 PSI	2"	84180FE	2"	59653F
Oil Pressure Gauge (SW) 0-100 PSI	2"	84181FE	2"	62750F
Oil Pressure Gauge (VDO) 5 bar	2"	84260FE	2"	59260F
Oil Pressure Gauge (VDO) 10 bar	2"	84261FE	2"	63532F
Oil Pressure Gauge (SW) 5 bar	2"	84263FE	2"	66263F
Oil Pressure Gauge (SW) 10 bar	2"	84264FE	2"	66264F
Turbo Boost	2"	61764FKE	2"	66266F
Water Pressure Kit (Outboard) 0-15 PSI				
Water Pressure Kit (Outboard) 0-40 PSI	2"	67386FE	2"	67380F
Speedo Kit 0-35 mph (Incl. Pitot & Hose)	3"	84521FE	3"	61751F
Speedo Kit 0-50 mph (Incl. Pitot & Hose)	3"	84510FE	3"	61752F
Speedo Kit 0-65 mph (Incl. Pitot & Hose)	3"	84513FE	3"	59713F
Speedo Kit 0-40 Knots (Incl. Pitot & Hose)				
Speedo Kit 0-50 Knots (Incl. Pitot & Hose)	3"	84576FE	3"	63533F
Speedo Kit 0-75 Knots (Incl. Pitot & Hose)	3"	84572FE	3"	63534F
Speedo Head Only 0-50mph	3"	63043FE	3"	61752FE
Speedo Head Only 0-65mph	3"	63044FE	3"	59713FE
Speedo head only (Pitot style) 0-50 knot	3"	63045FE		
Speedo head only (Pitot style) 0-75 knot	3"	63046FE		
MULTI (speed/temp/pressure)				
MULTI (pressure/temp/fuel/volt)				
Tachometer 0-4000 RPM Diesel Alt	3"	84279FE	3"	66267F
Tachometer 0-5000 RPM Diesel Alt	3"	67573FE		
Tachometer 0-4000 RPM Merc D-Tronic				
Tachometer 0-7000 RPM O/B & 4 Cycle Gas	3"	84293FE	3"	59737F
Tach/Hour 0-4000 RPM Diesel	3"	84324FE	3"	63524F
Tach/Hour 0-7000 RPM O/B & 4 Cycle Gas	3"	70604FE	3"	65129FE
System Check Suzuki	2"	65668BMDFE	2"	65669SSF
System Check OMC	2"	65645BMDFE	2"	65206SSF
Water Temp (SW) 120-240°F	2"	84590FE	2"	59654F
Water Temp (VDO) 40-120°C	2"	84660FE	2"	63535F
Water Temp (SW) 40-120°C	2"	84661FE	2"	66268F
Trim Gauge Evinrude/Johnson Outboard/Suzuki >2002	2"	84740FE	2"	61753F
Trim Gauge Honda Outboard	2"	84746FE	2"	63526F
Trim Gauge Mariner/Merc, OMC Cobra, Yamaha 2001 SternDrive	2"	84742FE	2"	59657F
Trim Gauge Yamaha Outboards, pre 2001 SternDrive	2"	84744FE	2"	62445F
Amperemeter, 60-0-60A	2"	84710FE	2"	60710F
Battery check	2"	84135FE	2"	66270F
Voltmeter 12v	2"	84134FE	2"	59656F
Voltmeter 24v	2"	84131FE	2"	66269F
Engine Synchronizer Gauge	2"	84730FE		
Transmission Pressure Gauge (VDO) 0-350PSI/25 bar	2"	84265FE	2"	66265F
Water Tank Gauge (VDO)	2"	84160FE	2"	66412F (VDO)
Water Tank Gauge (SW)	2"	70605FE	2"	70606FE
Black Water Tank Gauge (VDO)	2"	84161FE	2"	66413F (VDO)
Waste Tank 240-33 ohms	2"	67265FE		
Rudder Position Indicator	2"	84770FE	2"	66271F
Depth Gauge (Standard lens!)	2"	67874E	2"	67399E

## 12V instruments





**Argent Pro  
Fog Resistant**

**Omega  
Standard Lens**

**White Domed  
Standard Lens**

**Sender  
(See page 328-329)**

2"	65524SSF	2"	57902E		F
2"	67582SSF				VDO
2"	65518SSF	2"	58154E		-
2"	65526SSF	2"	57903E	2"	31180E
2"	65525SSF	2"	57929E	2"	31181E
2"	70602SSF	2"	62155E	2"	31260E
2"	67578SSF	2"	62156E		VDO
2"	70601SSF				C
2"	67577SSF				C
2"	70599SSF				-
		2"	59630E	2"	31375E
2"	65551SSF	2"	58392E	2"	31370E
3"	70610SSF	3"	58342E		G (incl.)
3"	65557SSF	3"	57898E		G (incl.)
3"	65531SSF	3"	57900E		G (incl.)
		3"	62157E	3"	31570E
3"	67189SSF				G (incl.)
		3"	62158E		G (incl.)
5"	65530SSF				G of motorfabrikant
3"	65557SSF				G of motorfabrikant
3"	67189SSF				
3"	70611SSF				
5"	780742PDFE (Multi)				G-C-D
5"	65520SSF (Multi)				C-D-F
3"	65537SSF / 5" 65538SSF	3"	58136E	3"	31279E
3"	67574SSF				zie T
3"	67549SSF				zie T
3"	65535SSF / 5" 65536SSF	3"	58255E		Dynamo/spoel
3"	65541SSF / 5" 65544SSF				zie T
3"	65545SSF / 5" 65546SSF				Dynamo/spoel
2"	65694SSF				Motorfabrikant
2"	65528SSF				Motorfabrikant
2"	65553SSF	2"	57904E		D
2"	67576SSF	2"	62159E		VDO
2"	67575SSF				D
2"	65547SSF	2"	58431E	2"	31740E
2"	65549SSF				Motorfabrikant
2"	65548SSF	2"	57905E		Motorfabrikant
2"	70596SSF	2"	61748E	2"	31744E
2"	70609SSF	2"	59310E	2"	31710E
2"	70598SSF				-
2"	65550SSF	2"	57901E		-
2"	70597SSF	2"	64279E		-
2"	65522SSF				
2"	70600SSF				VDO
2"	67581SSF (VDO)				VDO
2"	67579SSF (SW)				allpa
				VDO	
2"	75527SSF				H
2"	67412E				-

## 12V instruments



### Digital Depth Sounders 2" Models

Teleflex digital depth sounder with high speed dual mount transducer allowing mounting on transom or in hull\*. Color coordinated to match popular Teleflex Marine engine gauge series. Water depth reading to 60m with instant depth readings at speeds up to 100 km/h.

Lenght cable 25 feet.

<b>Item Code 67412E</b>	Model Argent-Pro with stainless steel bezel
<b>Item Code 67399E</b>	Model Lido-Pro with stainless steel bezel
<b>Item Code 67874E</b>	Model Premier-Pro

**Item Code 67309** Transmitter only

\* Suitable for polyester hulls; Transmitter must be glued



### Rudder Position Indicators

Rudder Position Gauges (fog resistant):

<b>Item Code 66271F</b>	Lido Pro 12V
<b>Item Code 84770FE</b>	Premier Pro 12V
<b>Item Code 75527SSFE</b>	Argent Pro 12V

Rudder Position Sensor

**Item Code 021510** For single station, 0-90°, 12/24V complete with adjustable arms

Note: with 24V on-board grid, you need a volt-reducer for the gauge and a 24V bulb must be placed. Please see p.329.

For a second station please order an extra kit.



021510

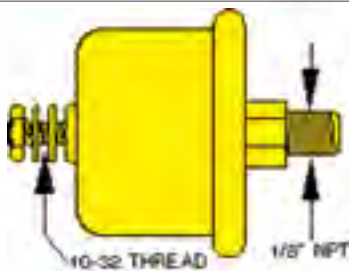

### Oil Pressure Sender

**CODE C** Oil pressure senders (240-33 Ohm)

Range	Single Station
80 PSI	<b>Item Code 1500171E</b>
100 PSI	<b>Item Code 1501671E</b>

(1 PSI = 0,069 bar)

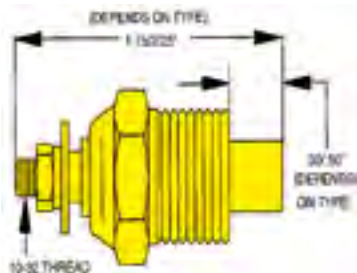

### Temperature senders

**CODE D** Temperature senders (120-240° F)

Thread	Single Station	Dual Station
1/8 NPT	<b>Item Code 52320E010</b>	*****
1/4 NPT	<b>Item Code 52320E004</b>	
3/8 NPT	<b>Item Code 52320E009</b>	
1/2 NPT	<b>Item Code 52320E003</b>	



### Fuel Sender

**CODE F**

Fuel Sender (240-33 Ohm range, S/W match 5-Hole flange, adjustable for left or right arm. Adjustable for 4-24" (10-61cm) deep tanks

Delrin flange, w/metal insert & (2) 10 stud terminals (includes Viton gasket and screws)

<b>Item Code 90424K</b>	Fuel sender
<b>Item Code 57902E</b>	Fuel gauge

**CODE T For Diesel or Low-RPM Inboard and Stern Drive Engines**

Alternator must have an AC-connection, usually indicated with „AC“, „R“ or „W“. You need to know how many poles the alternator has and select the right position of the switch at the rear of the tachometer. Calibration must be made using a jeweller's Screw- driver to carefully adjust the potentiometer in the "CAL" hole. Final calibration adjustment requires a Remote Master Tachometer.

**Tach & Tach/Hourmeter**  
(Diesel Alternator Type)



**CODE G Pitot tube**

- Item Code 56973E Pitot
- Item Code 56353E Pitot tube 30m (100')

**Pitot Tube**

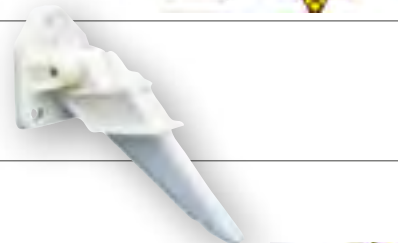

All Teleflex Marine Instruments are suitable for 12V DC.  
(Item Code 22.6090045A = 12V DC Lamp)  
For use in a 24V DC system you replace the 12V DC lamps by 24V DC lamps:  
Item Code 40102E007 24V DC lamp (set of two), GE400, 1.6 candles

**Volt reducers are not needed for:**

- speedo's
- ampere meters
- Hour counters

**Volt reducers are needed for:**

- Item Code 50446E004 For tachometers and electric speedo's
- Item Code 6221776E For Johnson/Evinrude trimmers
- Item Code 6219371E For all other 2" instruments

**24V DC Lamp / Volt reducers**

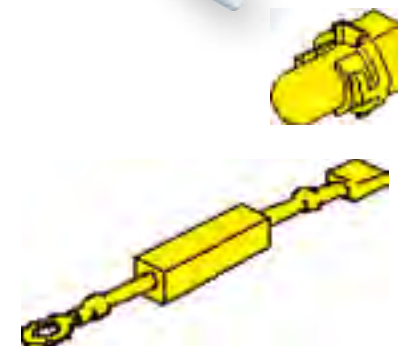

**CODE WP**

Water Pressure Kit for Outboards  
(not separately available)

**Water Pressure Kit**



12/24V, 5-hole flange (ø54/70 mm)  
Fuel/Drinking Water senders have plastic floats.  
Drinking/Waste Water senders have S/S floats with specific self-cleaning feature.  
USA-Type for Teleflex-, Vetus-, Faria-Anzeiger etc.  
Special execution for VDO-gauges.

**Stainless steel Tank Senders**



Length	Fuel/Drinking water		Drinking/Waste water	
	USA 240-30 Ω	VDO 10-180 Ω	USA 240-30 Ω	VDO 10-180 Ω
160 mm	021810/T	021810/V		
200 mm	021811/T	021811/V	021811/WT	021811/WV
250 mm	021812/T	021812/V		
280 mm	021813/T	021813/V		
300 mm	021814/T	021814/V	021814/WT	021814/WV
320 mm	021815/T	021815/V		
350 mm	021816/T	021816/V		
380 mm	021817/T	021817/V		
400 mm	021818/T	021818/V	021818/WT	021818/WV
450 mm	021819/T	021819/V		
480 mm	021820/T	021820/V		
500 mm	021821/T	021821/V		

Item Code 021850 Spare seal

**allpa Windshield Wiper System  
Model ALPHA**



Features	
Motor	1-Speed, 12V/6W (ZD1132)
Consumption	≤ 5A (under load)
Working Torque	0.6Nm
Noise Level	≤ 40dB(A)
Max. Wall Thickness	19mm
Shaft length	58mm
Wiping Angle	90°
Oscillate Shaft Speed	27 ± 3 /min (under load)
Protection	IP54 (Outdoor Use)
Switch	On Motor Body

Complete Kit	
<b>Item Code 096980</b>	<b>Complete Kit: Motor, Arm, Blade</b>

Separate Components	
Item Code 096001	Separate 12V motor
Item Code 096830	Wiper Arm 300mm, S/S 316
Item Code 096930	Wiper Blade 300mm, S/S 316

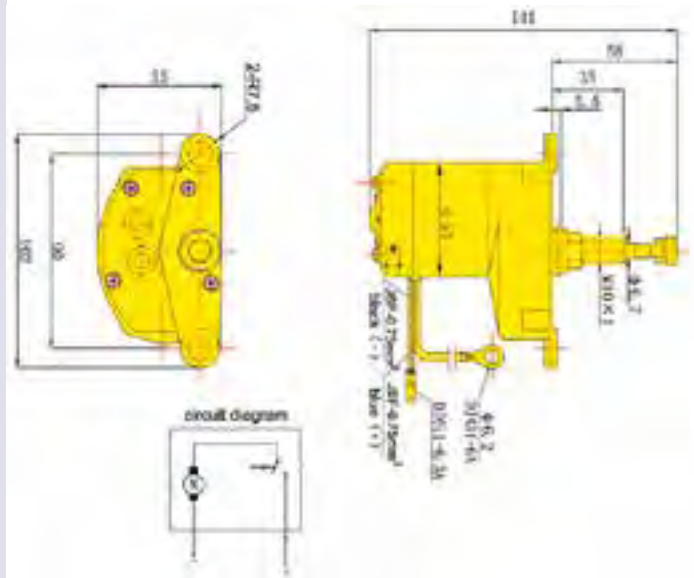

**allpa Windshield Wiper System  
Model GOLF**

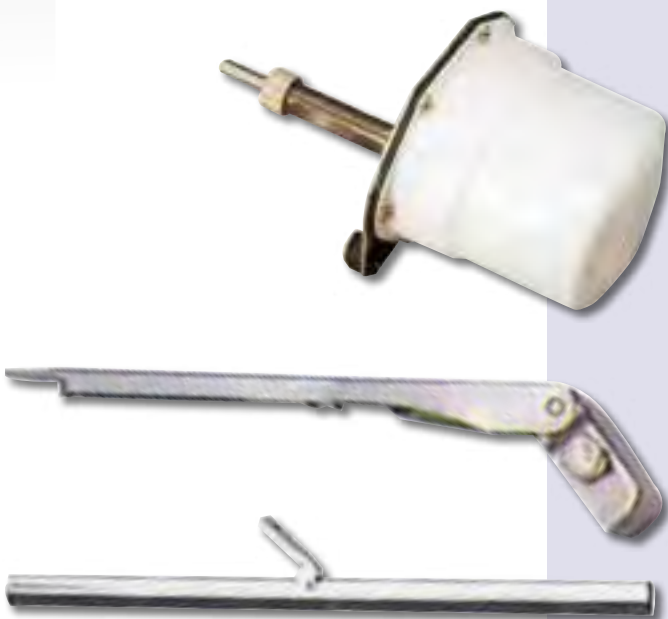

Features	
Motor	12V, 1-Speed
Noise Level	≤ 55dB(A)
Max. Wall Thickness	35mm
Shaft length	92mm
Wiping Angle	90°
Oscillate Shaft Speed	35 ± 3 /min (under load)

Complete Kits	
<b>Item Code 078300/S</b>	<b>Complete kit 12V: Motor, Arm, Blade</b>
<b>Item Code 078301/S</b>	<b>Complete kit 24V: Motor, Arm, Blade</b>

Separate Components	
Item Code 078300	Separate 12V motor
Item Code 078301	Separate 24V motor
Item Code 078316	Wiper Arm 210-355mm, S/S 316
Item Code 078311	Wiper Blade 355mm, S/S 316

## allpa Windshield Wiper System Model BRAVO

Features	
Motor	2-Speed, 12V/20W (ZD1230BA)
Consumption-1	≤ 2.4A Low (under load)
Consumption-2	≤ 3.6A High (under load)
Working Torque	1.5Nm
Noise Level	≤ 50dB(A)
Max. Wall Thickness	19mm
Shaft Length	48mm
Wiping Angle	90°
Oscillate Shaft Speed-1	35 ± 4 /min (under load)
Oscillate Shaft Speed-2	50 ± 5 /min (under load)
Protection	IP54 (Outdoor Use)
With Automatic Parking Position	
With Automatic Over Load Protection	
Complete Kit	
<b>Item Code 096105</b>	<b>Kit with: motor (096005), wiper arm (096545), wiper blade (096940) &amp; 3-position push-pull switch (096404)</b>
Losse onderdelen	
<b>Item Code 096005</b>	Losse 12V motor
Wiper Arms Stainless Steel 316	
<b>Item Code 096840</b>	Single Arm 400mm
<b>Item Code 096845</b>	Single Arm 450mm
<b>Item Code 096850</b>	Single Arm 500mm
<b>Item Code 096645</b>	Single Arm adjustable 350-450mm
<b>Item Code 096655</b>	Single Arm adjustable 450-500mm
<b>Item Code 096740</b>	Pantograph Arm 400mm
<b>Item Code 096745</b>	Pantograph Arm 450mm
<b>Item Code 096750</b>	Pantograph Arm 500mm
<b>Item Code 096545</b>	Pantograph Arm adjustable 350-450mm
<b>Item Code 096550</b>	Pantograph Arm adjustable 450-550mm
Wiper Blades Stainless Steel 316	
<b>Item Code 096935</b>	Wiper Blade 350mm
<b>Item Code 096940</b>	Wiper Blade 400mm
<b>Item Code 096945</b>	Wiper Blade 450mm
<b>Item Code 096950</b>	Wiper Blade 500mm
ALL-WIS Flat Blade Wiper Blades for Single Arms only (De Luxe)	
<b>Item Code 041600</b>	Flat Blade Wiper Blade 14" - 350mm
<b>Item Code 041605</b>	Flat Blade Wiper Blade 16" - 400mm
<b>Item Code 041610</b>	Flat Blade Wiper Blade 18" - 450mm
<b>Item Code 041615</b>	Flat Blade Wiper Blade 20" - 500mm
Accessoires	
<b>Item Code 096404</b>	3-Position Push-Pull Switch for Wiper Motor
<b>Item Code 096401</b>	Windshield Washing Kit XD-105 12V + Tank and 6m slang
<b>Item Code 096403</b>	Washing Nozzle for Single Arm, with Tube
<b>Item Code 096407</b>	Washing Nozzle for Pantograph Arm, with Tube
<b>Item Code 025261</b>	S/S Washing Push Button with Blue LED-Ring 12V
<b>Item Code 025266</b>	S/S Washing Push Button with Blue LED-Ring 24V

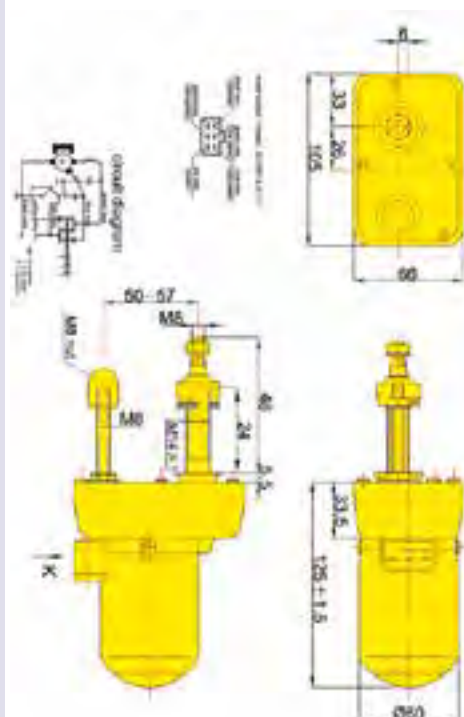

## allpa Windshield Wiper System Model CHARLY

Features	
Motor	2-Speed, 12V/20W (ZD1233AA)
Motor	2-Speed, 24V/20W (ZD2233AA)
Consumption-1	≤12V5.0A/24V2.5ALow(underload)
Consumption-2	≤12V7.0A/24V3.5AHigh(underload)
Working Torque	3.43Nm
Noise Level	≤ 50dB(A)
Max. Wall Thickness	13 or 25mm
Shaft Length	43 or 68mm
Wiping Angle	Adjustable: 50-70-90-100°
Oscillate Shaft Speed-1	30 ± 4 /min (under load)
Oscillate Shaft Speed-2	40 ± 4 /min (under load)
Protection	IP54 (Outdoor Use)
With Automatic Parking Position	
With Automatic Over Load Protection	

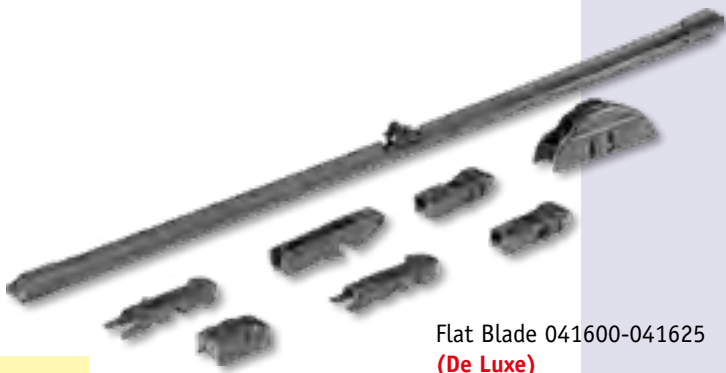
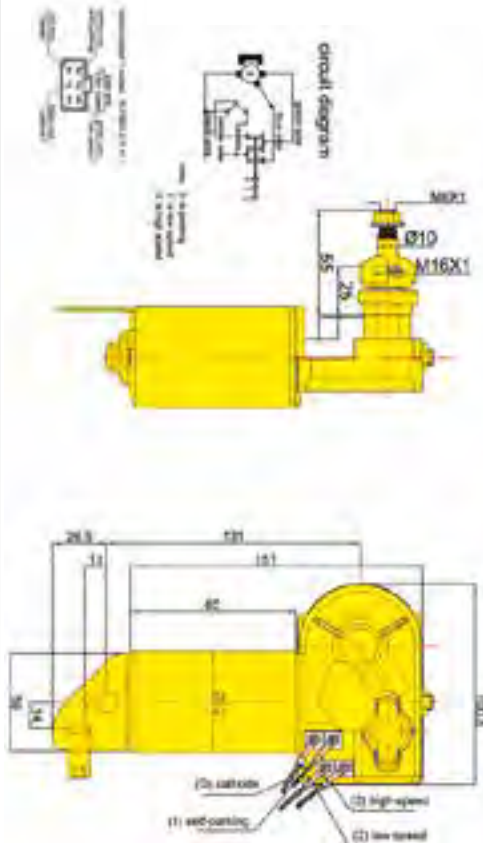

Flat Blade 041600-041625  
(De Luxe)

### Separate Components

Code 096011	Separate 12V Motor-netto shaft length 25mm
Code 096012	Separate 12V Motor-netto shaft length 53mm
Code 096010	Separate 24V Motor-netto shaft length 25mm
Code 096013	Separate 24V Motor-netto shaft length 53mm
<b>Wiper Arms Stainless Steel 316</b>	
Code 096835	Single Arm 350mm
Code 096840	Single Arm 400mm
Code 096845	Single Arm 450mm
Code 096850	Single Arm 500mm
Code 096645	Single Arm adjustable 350-450mm
Code 096655	Single Arm adjustable 450-500mm
Code 096660	Single Arm adjustable 500-600mm
Code 096736	Pantograph Arm 350mm
Code 096741	Pantograph Arm 400mm
Code 096746	Pantograph Arm 450mm
Code 096751	Pantograph Arm 500mm
Code 096546	Pantograph Arm adjustable 350-450mm
Code 096551	Pantograph Arm adjustable 450-550mm
Code 096561	Pantograph Arm adjustable 500-600mm
<b>Wiper Blades Stainless Steel 316</b>	
Code 096935	Wiper Blade 350mm
Code 096940	Wiper Blade 400mm
Code 096945	Wiper Blade 450mm
Code 096950	Wiper Blade 500mm
Code 096955	Wiper Blade 550mm
<b>ALL-WIS Flat Blade Wiper Blades for Single Arms only (De Luxe)</b>	
Code 041600	Flat Blade Wiper Blade 14" - 350mm
Code 041605	Flat Blade Wiper Blade 16" - 400mm
Code 041610	Flat Blade Wiper Blade 18" - 450mm
Code 041615	Flat Blade Wiper Blade 20" - 500mm
Code 041620	Flat Blade Wiper Blade 21" - 525mm
Code 041625	Flat Blade Wiper Blade 24" - 600mm
<b>Accessoires</b>	
Code 096404	3-Position Push-Pull Switch for Wiper Motor
Code L061012601	12V Rocker Switch ON-OFF-ON
Code L061012624	24V Rocker Switch ON-OFF-ON
Code 078318	Control Box for 1-3 Motors (with Interval)
Code 096401	Windshield Washing Kit XD-105 12V + Tank and 6m slang
Code 096402	Windshield Washing Kit XD-105 24V + Tank and 6m slang
Code 096403	Washing Nozzle for Single Arm, with Tube
Code 096407	Washing Nozzle for Pantograph Arm, with Tube
Code 025261	S/S Washing Push Button with Blue LED-Ring 12V
Code 025266	S/S Washing Push Button with Blue LED-Ring 24V

# allpa Windshield Wiper System Model CHARLY

**ECO**



Model CHARLY		Complete Kit Nr. 1
Item Code 096991	<b>De Luxe</b>	Kit with: Motor 12V, shaft length 53mm (096012), adjustable Single Arm (096655), Flat Blade Wiper Blade 460mm (041610) & Rocker Switch (L061012601)
Model CHARLY		Complete Kit Nr. 2
Item Code 096992	<b>De Luxe</b>	Kit with: Motor 12V, shaft length 25mm (096011), adjustable Single Arm (096655), Flat Blade Wiper Blade 460mm (041610) & Rocker Switch (L061012601)

Model CHARLY		Complete Kit Nr. 3
Item Code 096993	<b>ECO</b>	Kit with: Motor 12V, shaft length 53mm (096012), adjustable Pantograph Arm (096551), S/S Wiper Blade 400mm (096940) & Rocker Switch (L061012601)
Model CHARLY		Complete Kit Nr. 4
Item Code 096994	<b>ECO</b>	Kit with: Motor 12V, shaft length 25mm (096011), adjustable Pantograph Arm (096551), S/S Wiper Blade 400mm (096940) & Rocker Switch (L061012601)

Available Control Switches and Control Box	
1-3 Motors 12V	1-3 Motors 24V
Item Code <b>L061012601</b> Rocker Switch ON-OFF-ON (1 x per motor) Switch-mounting frames: See p.333	Item Code <b>L061012624</b> Rocker Switch ON-OFF-ON (1 x per motor) Switch-mounting frames: See p.333
Item Code <b>096404</b> 3-Position Push-Pull Switch (1 x per motor)	Item Code <b>096404</b> 3-Position Push-Pull Switch (1 x per motor)
Item Code <b>078318</b> Control Box 12V with interval, low & high speed. For 1-3 motoren	Item Code <b>078319</b> Control Box 24V with interval, low & high speed. For 1-3 motoren

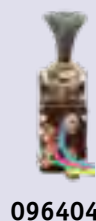

L061012601/  
L061012624



## allpa Windshield Wiper System Model ECHO

Features	
Motor	2-Speed, 12V/30W (ZD1330C)
Motor	2-Speed, 24V/20W (ZD2330C)
Consumption-1	≤ 12V 5.0A / 24V 2.5A Low (under load)
Consumption-2	≤ 12V 7.0A / 24V 3.5A High (under load)
Working Torque	3.5Nm
Noise Level	≤ 50dB(A)
Max. Wall Thickness	19mm
Shaft Length	65mm
Wiping Angle	Adjustable: 50-70-90-100°
Oscillate Shaft Speed-1	32 ± 3 /min (under load)
Oscillate Shaft Speed-2	46 ± 4 /min (under load)
Protection	IP54 (Outdoor Use)
With Automatic Parking Position	
With Automatic Over Load Protection	
Separate Components	
Item Code 096021	Separate 12V Separate
Item Code 096022	Separate 24V Separate
Wiper Arms Stainless Steel 316	
Item Code 096835	Single Arm 350mm
Item Code 096840	Single Arm 400mm
Item Code 096845	Single Arm 450mm
Item Code 096850	Single Arm 500mm
Item Code 096645	Single Arm adjustable 350-450mm
Item Code 096655	Single Arm adjustable 450-500mm
Item Code 096660	Single Arm adjustable 500-600mm
Item Code 096735	Pantograph Arm 350mm
Item Code 096740	Pantograph Arm 400mm
Item Code 096745	Pantograph Arm 450mm
Item Code 096750	Pantograph Arm 500mm
Item Code 096545	Pantograph Arm adjustable 350-450mm
Item Code 096550	Pantograph Arm adjustable 450-550mm
Item Code 096560	Pantograph Arm adjustable 500-600mm
Wiper Blades Stainless Steel 316	
Item Code 096935	Wiper Blade 350mm
Item Code 096940	Wiper Blade 400mm
Item Code 096945	Wiper Blade 450mm
Item Code 096950	Wiper Blade 500mm
Item Code 096955	Wiper Blade 550mm
ALL-WIS Flat Blade Wiper Blade for Single Arms only (De Luxe)	
Item Code 041600	Flat Blade Wiper Blade 14" - 350mm
Item Code 041605	Flat Blade Wiper Blade 16" - 400mm
Item Code 041610	Flat Blade Wiper Blade 18" - 450mm
Item Code 041615	Flat Blade Wiper Blade 20" - 500mm
Item Code 041620	Flat Blade Wiper Blade 21" - 525mm
Item Code 041625	Flat Blade Wiper Blade 24" - 600mm
Accessoires	
Item Code 096405	3-Position Push-Pull Switch for Wiper Motor
Item Code L061012601	12V Rocker Switch ON-OFF-ON
Item Code L061012624	24V Rocker Switch ON-OFF-ON
Item Code 078318	Control Box for 1-3 Motors (with Interval)
Item Code 096401	Windshield Washing Kit XD-105 12V + Tank and 6m slang
Item Code 096402	Windshield Washing Kit XD-105 24V + Tank and 6m slang
Item Code 096403	Washing Nozzle for Single Arm, with Tube
Item Code 096407	Washing Nozzle for Pantograph Arm, with Tube
Item Code 025261	S/S Washing Push Button with Blue LED-Ring 12V
Item Code 025266	S/S Washing Push Button with Blue LED-Ring 24V

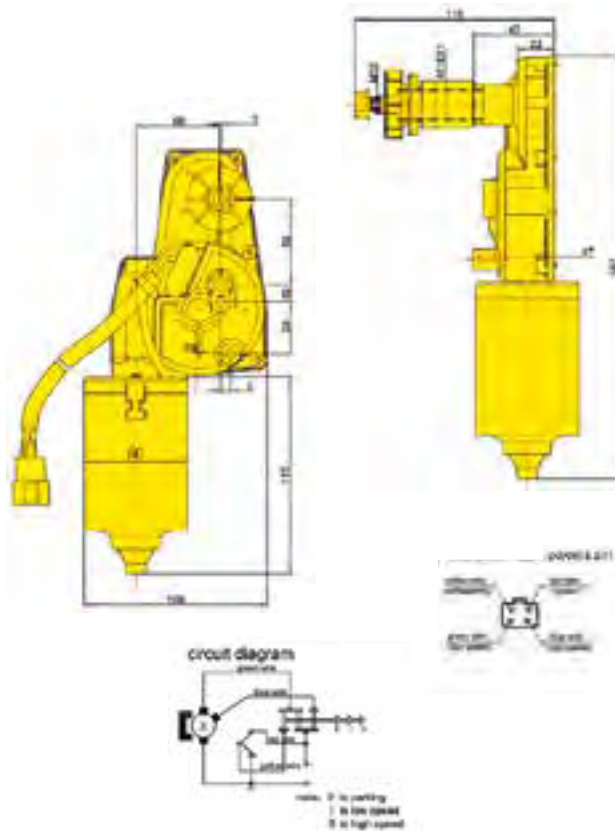

### Available Control Switches and Control Box

1-3 Motors 12V	1-3 Motors 24V
<b>Item Code L061012601</b> Rocker Switch ON-OFF-ON (1 x per motor) Switch-mounting frames: See p.333	<b>Item Code L061012624</b> Rocker Switch ON-OFF-ON (1 x per motor) Switch-mounting frames: See p.333
<b>Item Code 096405</b> 3-Position Push-Pull Switch (1 x per motor)	<b>Item Code 096405</b> 3-Position Push-Pull Switch (1 x per motor)
<b>Item Code 078318</b> Control Box 12V with interval, low & high speed. For 1-3 motoren	<b>Item Code 078319</b> Control Box 12V with interval, low & high speed. For 1-3 motoren



# allpa Windshield Wiper System Model FOXTROT

Features	
Motor	2-Speed, 12V/40W (ZD1530B)
Motor	2-Speed, 24V/40W (ZD2530B)
Consumption-1	≤ 12V 7.0A / 24V 3.5A Low (under load)
Consumption-2	≤ 12V 9.0A / 24V 4.5A High (under load)
Working Torque	5.0Nm
Noise Level	≤ 50dB(A)
Max. Wall Thickness	19mm
Shaft Length	80mm
Wiping Angle	90°
Oscillate Shaft Speed-1	33 ± 3 /min (under load)
Oscillate Shaft Speed-2	48 ± 5 /min (under load)
Protection	IP54 (Outdoor Use)



With Automatic Parking Position  
With Automatic Over Load Protection

Separate Parts	
Code 096025	Separate 12V Motor
Code 096026	Separate 24V Motor
Wiper Arms Stainless Steel 316	
Code 096752	Pantograph Arm 500mm
Code 096552	Pantograph Arm adjustable 450-550mm
Code 096562	Pantograph Arm adjustable 500-600mm
Wiper Blades Stainless Steel 316	
Code 096950	Wiper Blade 500mm
Code 096955	Wiper Blade 550mm
Code 096960	Wiper Blade 600mm
ALL-WIS Flat Blade Wiper Blades for Single Arms only (De Luxe)	
Code 041615	Flat Blade Wiper Blade 20" - 510mm
Code 041620	Flat Blade Wiper Blade 21" - 535mm
Code 041625	Flat Blade Wiper Blade 24" - 610mm
Accessoires	
Code 096406	3-Position Push-Pull Switch for Wiper Motor
Code L061012601	12V Rocker Switch ON-OFF-ON
Code L061012624	24V Rocker Switch ON-OFF-ON
Code 078318	Control Box for 1-3 Motors (with Interval)
Code 096401	Windshield Washing Kit XD-105 12V + Tank and 6m slang
Code 096402	Windshield Washing Kit XD-105 24V + Tank and 6m slang
Code 096403	Washing Nozzle for Single Arm, with Tube
Code 096407	Washing Nozzle for Pantograph Arm, with Tube
Code 025261	S/S Washing Push Button with Blue LED-Ring 12V
Code 025266	S/S Washing Push Button with Blue LED-Ring 24V

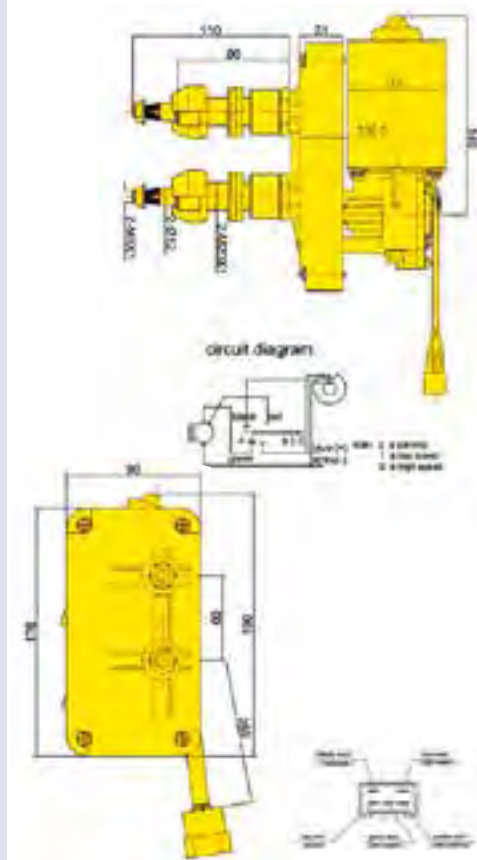

Available Control Switches and Control Box	
1-3 Motors 12V	1-3 Motors 24V
<b>Item Code L061012601</b> Rocker Switch ON-OFF-ON (1 x per motor) Switch-mounting frames: See p.333	<b>Item Code L061012624</b> Rocker Switch ON-OFF-ON (1 x per motor) Switch-mounting frames: See p.333
<b>Item Code 096406</b> 3-Position Push-Pull Switch (1 x per motor)	<b>Item Code 096406</b> 3-Position Push-Pull Switch (1 x per motor)
<b>Item Code 078318</b> Control Box 12V with interval, low & high speed. For 1-3 motoren	<b>Item Code 078319</b> Control Box 24V with interval, low & high speed. For 1-3 motoren



**Battery Main Switch**

- Item Code 210086** 120A continuous, CE-approval, plastic, double pole
- Item Code 210084/N** 100A continuous, plastic
- Item Code 210084/C** 140A continuous, chromed brass/plastic

**Battery Main Switch/Key**

- Item Code 041001** Spare Key for Battery Main Switch 210084/C & 210086
- Item Code 041000** Cover for 041001
- Item Code 210084/S** Spare Key for Battery Main Switch 210084/N & 078665



**Battery Switch**

- Item Code L0610090**  
Battery Switch, ON / OFF  
180A: Continuous, 1000A: 5 sec.  
Silver plated brass studs and nuts,  
nylon base and PVC knob.  
Dims.: Ø66mm, H=97mm



**Battery Selector Switch**

- Item Code L0670002** Battery main switch Continuous 180A. With plastic built-in unit and cover. Ø70mm
- Item Code L0670002/S** Spare Key for Battery Main Switch L0670002

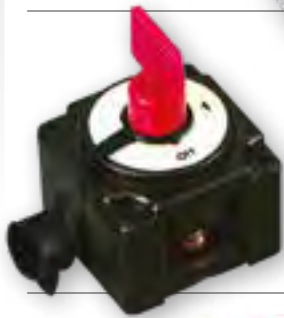

**Battery Selector Switch**

- Item Code L0610193** Battery selector switch Continuous 250A.  
Dims. 71,5x71,5x105,2mm  
Splash proof
- Item Code L0610193/S** Spare Key for Battery Main Switch L0610193



**Battery Selector Switch**

- Item Code L0610003** 250A



**Battery Selector Switch**

- Item Code L0612350**  
Continuous 350A / 12V. Splash waterproof.  
Dims. 140 x 140 x 90 (L x w x h)

**Item Code 041460 275A** – Battery Switch, ON/OFF

275A: Continuous - 455A: 5 min - 1250A: 10 sec.,  
 12/24V, Dims. 68x 68x76mm. Max 48V  
 2x10mm Tin plated copper studs and nuts  
 Also suitable for recess mount: cut out size Ø52mm  
 Removable knob (not as spare item available)

**Item Code 041464 600A** – Battery Switch, ON/OFF

600A: Continuous - 800A: 5 min - 2500A: 10 sec.,  
 12/24V, Dims.102x102x90mm. Max. 48V  
 2x12mm Tin plated copper studs and nuts  
 Also suitable for recess mount: cut out size Ø85mm

**Item Code 041462 350A** – Battery Selector Switch, 1-2-Both-OFF

350A: Continuous - 500A: 5 min - 1500A: 10 sec.,  
 12/24V, Dims.102x102x90mm. Max 48V  
 3x10mm Tin plated copper studs and nuts  
 Also suitable for recess mount: cut out size Ø85mm  
 Contour Lock system with removable plates for connection from  
 all sides! Selector switch can also be padlocked.

With the help of a threaded ring nut it is possible  
 to install the switch on panels up to 19mm thick.  
 The button can be removed by simply turning it  
 45° counterclockwise rotation.

**Item Code L0610843**

ON/OFF 275A Mounting: built-in or surface-mounted

Compact switch for panel or bulkhead mounting.

**Item Code L0610823**

ON/OFF/OUT 200A Ø45mm

**Item Code L0610842**

ON/OFF/OUT 300A Ø55mm

**Item Code 64BS11000** 275A - Battery Switch, ON/OFF

275A continuous - 455A 5 min -1250A 10 sec.,  
 12/24V, Max 48V

**Item Code 64BS11020** 200A - Battery Switch, 1-2-Both-OFF

200AA continuous - 300A 5 min -1000A 10 sec.,  
 12/24V, Max 48V

**Battery Switches  
& Selector  
Switch**



**Battery Switches**



**Battery Switches**



**Sierra  
Battery Switches**

**NEW**



**Sierra  
Battery Switches**

**NEW**





### Terminal Box

**Item Code L0610094** Watertight terminal box  
2 x 4 terminal. Dims. 127x76x45mm

**Item Code L0610095** Watertight terminal box  
2 x 8 terminal. Dims. 140x102x54mm



### Terminal Box

Tin bar on ABS base

**Item Code 078645** 4x Terminal Ø6mm  
A=152mm, B=31mm, 150A

**Item Code 078646** 6x Terminal Ø6mm  
A=231mm, B=31mm, 150A

**Item Code 078640** 5x Terminal Ø5mm  
A=106mm, B=22mm, 100A

**Item Code 078641** 10x Terminal Ø6mm  
A=152mm, B=31mm, 150A

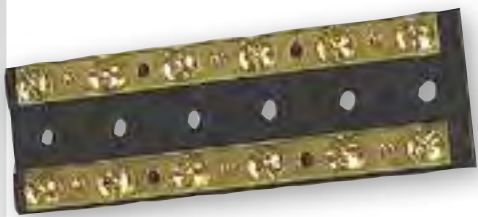

### Junction Block

Black molded base with two solid brass bus bars.  
Screw terminals with 8-32 threads.

**Item Code 64FS40680** 2 x 6 Terminal Ø6mm



### In-Line zekeringshouder

**Item Code 078460** 30A, cable Ø10mm

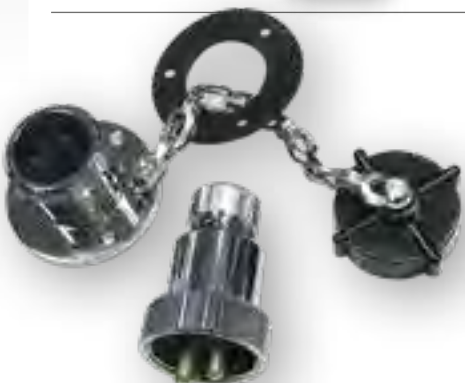

### Waterproof Deck Plugs & Sockets

**Item Code L0611536** 3A 2 pins (plastic cover) Ø36, H=55

**Item Code L0611539** 3A 3 pins (plastic cover) Ø36, H=55

**Item Code 078465** 5A 2 pins (plastic cover) Ø44,5, H=65

**Item Code 078466** 5A 3 pins (plastic cover) Ø44,5, H=65

**Item Code 078467** 5A 4 pins (plastic cover) Ø44,5, H=65



### Waterproof Cable Leads

Chromed Brass Deck Fittings.

	Grooved Nut ø Cable	Hexagonal Nut ø Cable
<b>Item Code 078470</b>	6mm	<b>Item Code 078473</b> 12mm
<b>Item Code 078471</b>	8mm	<b>Item Code 078474</b> 16mm
<b>Item Code 078472</b>	10mm	<b>Item Code 078475</b> 19mm

Isolated single Terminal.  
Tin plate on ABS Base

<b>Item Code 025200</b>	Red	8mm
<b>Item Code 025201</b>	Red	10mm
<b>Item Code 025205</b>	Black	8mm
<b>Item Code 025206</b>	Black	10mm

### Isolated Terminal Single



Isolated twin Terminal.  
Tin plate on ABS Base

<b>Item Code 025210</b>	Black	2x6mm
<b>Item Code 025211</b>	Black	2x10mm

With spacer:

<b>Item Code 025215</b>	Black	2x10mm
-------------------------	-------	--------

### Isolated Terminal Twin

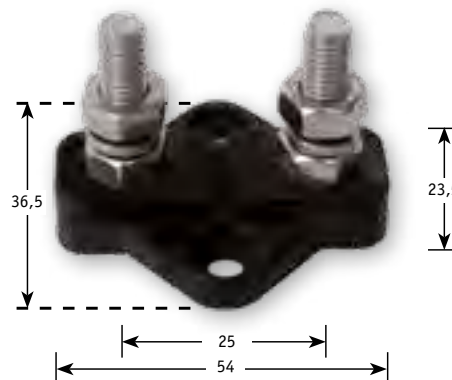

#### 1. Fuse holder of bakelite

<b>Item Code 025220</b>	30 to 200A
-------------------------	------------

#### 2. Fuse holder of Nylon with cover of polycarbonate

<b>Item Code 025225</b>	35 to 200A
-------------------------	------------

#### Separate fuses

Copper alloy with bakelite cover

Item Code	Ampère
025235	35A
025236	50A
025237	80A
025238	100A
025239	150A
025240	200A



### Fuse Holders

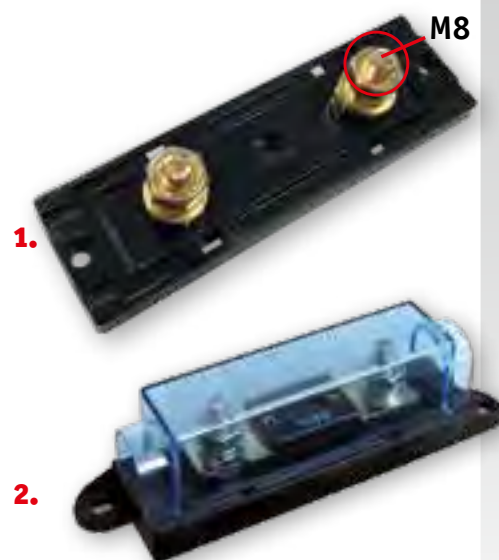

Max. 25A continuous. Max. peak 150A - 10sec. Max. voltage 32VDC. ABS body with polycarbonate cover and tinned copper terminals. Including several labels. Without fuses.

<b>Item Code 025230</b>	6 - Positions
<b>Item Code 025231</b>	8 - Positions
<b>Item Code 025232</b>	10 - Positions
<b>Item Code 025233</b>	12 - Positions

**Item Code 025234**  
Set of plug fuses consisting of:

Ampère	Color
3 x 5A	Tan
1 x 7,5A	Coffee
3 x 10A	Red
3 x 15A	Blue
1 x 20A	Yellow
1 x 25A	Transparent



### Fuse holders





### Stainless Steel Push Button with LED ring

Code	LED Color	Volt	Amp.	Ring	Bore	Depth	Type
025250	Red	12V	3A	Ø18mm	Ø16mm	36mm	ON/OFF
025251	Red	12V	3A	Ø18mm	Ø16mm	36mm	(ON)/OFF
025252	Red	12V	3A	Ø25mm	Ø22mm	40mm	ON/OFF
025253	Red	12V	3A	Ø25mm	Ø22mm	40mm	(ON)/OFF
025260	Blue	12V	3A	Ø18mm	Ø16mm	36mm	ON/OFF
025261	Blue	12V	3A	Ø18mm	Ø16mm	36mm	(ON)/OFF
025262	Blue	12V	3A	Ø25mm	Ø22mm	40mm	ON/OFF
025263	Blue	12V	3A	Ø25mm	Ø22mm	40mm	(ON)/OFF
025255	Red	24V	3A	Ø18mm	Ø16mm	36mm	ON/OFF
025256	Red	24V	3A	Ø18mm	Ø16mm	36mm	(ON)/OFF
025257	Red	24V	3A	Ø25mm	Ø22mm	40mm	ON/OFF
025258	Red	24V	3A	Ø25mm	Ø22mm	40mm	(ON)/OFF
025265	Blue	24V	3A	Ø18mm	Ø16mm	36mm	ON/OFF
025266	Blue	24V	3A	Ø18mm	Ø16mm	36mm	(ON)/OFF
025267	Blue	24V	3A	Ø25mm	Ø22mm	40mm	ON/OFF
025268	Blue	24V	3A	Ø25mm	Ø22mm	40mm	(ON)/OFF

### Stainless Steel Push Button with LED dot

**Stainless Steel Push Button with LED illumination.**  
**Bore: Ø16mm. Depth: 36mm. Protection: IP40**



Code	LED Color	Volt	Amp.	Ring	Bore	Depth	Type
025270	Red	12V	3A	Ø18mm	Ø16mm	36mm	ON/OFF
025271	Red	12V	3A	Ø18mm	Ø16mm	36mm	(ON)/OFF
025280	Blue	12V	3A	Ø18mm	Ø16mm	36mm	ON/OFF
025281	Blue	12V	3A	Ø18mm	Ø16mm	36mm	(ON)/OFF
025275	Red	24V	3A	Ø18mm	Ø16mm	36mm	ON/OFF
025276	Red	24V	3A	Ø18mm	Ø16mm	36mm	(ON)/OFF
025285	Blue	24V	3A	Ø18mm	Ø16mm	36mm	ON/OFF
025286	Blue	24V	3A	Ø18mm	Ø16mm	36mm	(ON)/OFF

### Stainless Steel Buzzer with LED ring

**Stainless Steel Buzzer with LED illumination.**  
**Bore: Ø19mm, Depth: 54mm**



Code	LED Color	Volt	Amp.	Ring	Bore	Depth
025290	Red	12V	3A	Ø22mm	Ø19mm	54mm
025291	Red	24V	3A	Ø22mm	Ø19mm	54mm

### Toggle Switch LED illuminated

**Toggle Switch with LED illumination**



Code	LED Color	Volt	Amp.	Type
025292	Red	12V	3A	ON/OFF
025293	Red	24V	3A	ON/OFF
025294	Blue safety cover			

Maximum load 15A/12V.  
Come with 25 printed function legend labels

Item Code	Type	Poles	Switches
L061012301	SPST	3	ON - OFF
L061012302	SPST	3	(ON) - OFF
L061012401	DPST	4	ON - OFF
L061012402	DPST	4	(ON) - OFF
L061012501	SPDT	5	(ON) OFF ON
L061012601	DPDT	6	ON OFF ON
L061012602	DPDT	6	(ON) OFF (ON)

Item Code L0700058 Mounting frame for switch (left or right)

Item Code L0701058 Mounting frame for switch (centre)

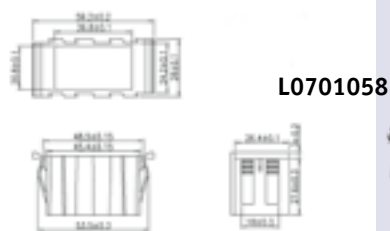

**Waterproof Switches with LED-indicator**

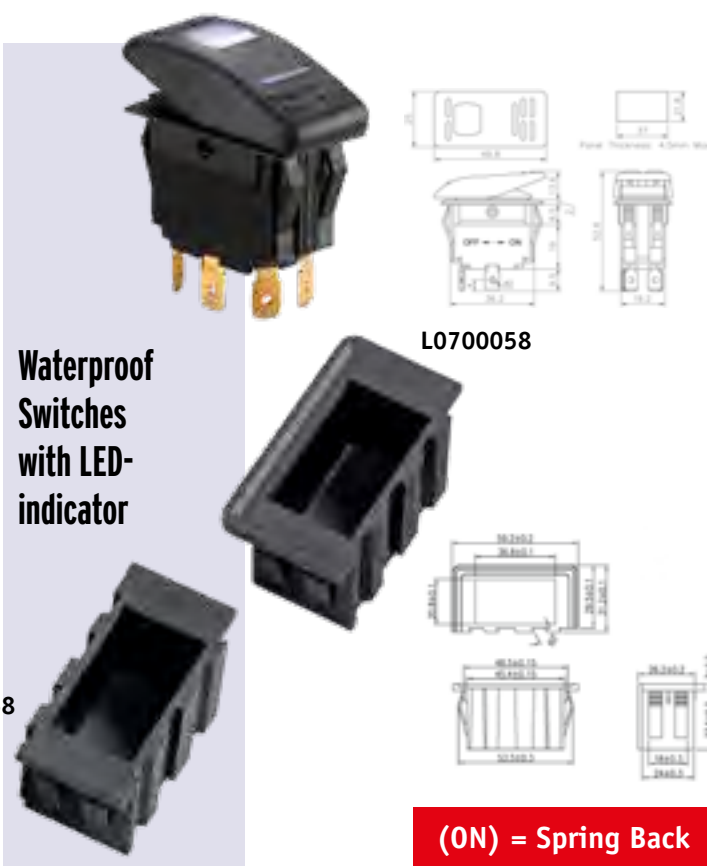

(ON) = Spring Back

20A/12V. Waterproof (IP68) HALO Permanently lit switches. Suitable for industry standard panel cutouts.

Item Code	LED Color	Type	Switch function
64RK40610B	Blue	SPST	ON - OFF
64RK40610G	Green	SPST	ON - OFF
64RK40620B	Blue	SPST	(ON) - OFF
64RK40620G	Green	SPST	(ON) - OFF
64RK40630B	Blue	SPST	ON - ON
64RK40630G	Green	SPST	ON - ON
64RK40640B	Blue	SPDT	ON - OFF - ON
64RK40640G	Green	SPDT	ON - OFF - ON
64RK40650B	Blue	DPST	ON - OFF
64RK40650G	Green	DPST	ON - OFF
64RK40660B	Blue	DPST	ON - ON
64RK40660G	Green	DPST	ON - ON
64RK40670B	Blue	DPDT	ON - OFF - ON
64RK40670G	Green	DPDT	ON - OFF - ON
64RK40680B	Blue	DPDT	(ON) - OFF - (ON)
64RK40680G	Green	DPDT	(ON) - OFF - (ON)
64RK40690B	Blue	SPDT	ON - OFF - ON
64RK40690G	Green	SPDT	ON - OFF - ON
64RK40700B	Blue	DPDT	ON - OFF - ON
64RK40700G	Green	DPDT	ON - OFF - ON

Item Code 64RS20200 Wire terminal

Item Code 64RS20180 17-20AWG, 15A

Item Code 64RS20190 13.5-17AWG, 15A

**NEW**

**Sierra Waterproof HALO Switches**



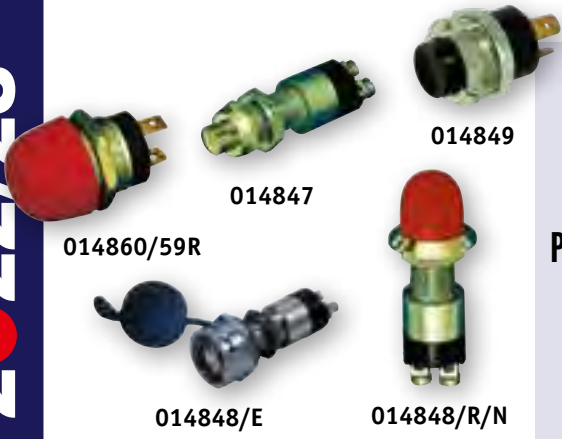

014847  
014860/59R  
014848/E  
014848/R/N  
014849

**Push Buttons**

<b>Item Code 014847</b>	30A, Bore Ø14mm, Chromed brass (E-Toilet)
<b>Item Code 014849</b>	20A, Bore Ø21mm, Chromed brass
<b>Item Code 014860/R</b>	20A Contact Switch Watertight, chromed brass, red cap Bore Ø21mm
<b>Item Code 014859/R</b>	20A Circuit Breaker Watertight, chromed brass, red cap Bore Ø21mm
<b>Item Code 014848/R</b>	30A, Bore Ø14mm, red cap, Chromed brass, watertight IP55
<b>Item Code 014848/N</b>	30A, Bore Ø14mm, black cap, Chromed brass, watertight IP55
<b>Item Code 014848/E</b>	30A, Bore Ø14mm, chromed brass, with cover



**Push-Pull Switches**

<b>Item Code 078450</b>	5A, 2 Position ON-OFF, Bore Ø8mm, Shaft length 7mm, plastic + chromed brass
<b>Item Code 078451</b>	5A, 2 Position ON-OFF, Bore Ø8mm, Shaft length 20mm, plastic + chromed brass

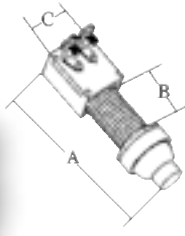
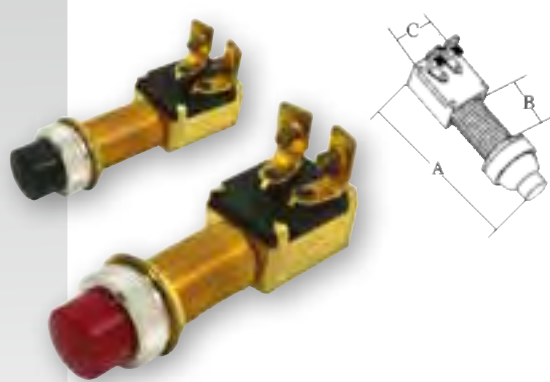

**Push Buttons**

12V, 2 Positions  
A = 28mm, B = 14mm, C = 18mm

<b>Item Code 078635</b>	Black (momentary)
<b>Item Code 078636</b>	Red (momentary)



**Waterproof Switch with LEDindicator**

Waterproof Switch with LED Indicator 12V/20A.  
IP-65 Plastic Housing  
Bore: Ø19mm

Item Code	Type	Poles	Switch
<b>L061011901</b>	SPST	3	ON - OFF

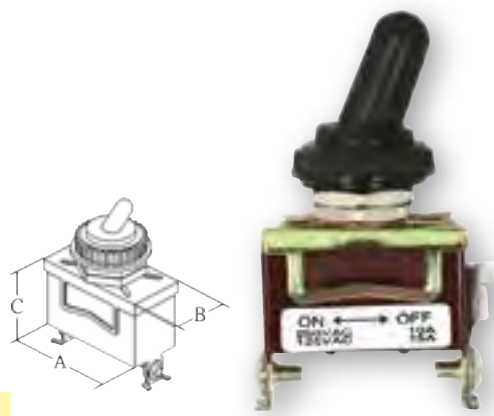

**Toggle Switch 12V**

Two position, Watertight 12V, 20A  
A = 28mm, B = 14mm, C = 18mm

<b>Item Code 078630</b>	
-------------------------	--



**NMEA kabels**

NMEA approved and specifically designed to meet marine requirements. Rated to IPX7 for reliable, watertight connections. Interchangeable with other NMEA 2000 products, premium metal connection collars ensure connections are tight and secure.

**2000 DROP kabel Micro-C (metal)**

Item Code	length in cm	Ancor #
64PC51140	60	270300
64PC51150	90	270301
64PC51160	180	270302
64PC51170	490	270305

**Item Code 64PC51050 (E)**

NMEA 2000 Power Tee cable  
ANCOR # 27000

**Item Code 64PC51060 (F)**

NMEA Micro 1 T piece  
ANCOR # 270101

**Item Code 64PC51070 (G)**

NMEA 2000 termination resistor  
ANCOR # 270105

**Item Code 64PC51080 (H)**

NMEA 2000 termination resistor  
ANCOR # 270106

**Item Code 64PC51090 (I)**

NMEA Micro 90 elbow  
ANCOR # 270108

**Item Code 64PC51100 (J)**

NMEA Micro 2 Tee piece  
ANCOR # 270103

**Item Code 64PC51110 (K)**

NMEA Micro 4 T piece  
ANCOR # 270104

**Item Code 64PC51120 (L)**

M12 metal cap for female conn  
ANCOR # 270112

**Item Code 64PC51130 (M)**

M12 metal cap for conn  
ANCOR # 270111

**Item Code 64PC51180 (N)**

NMEA 2000 Hub



NMEA kabels

**NEW**



**Waterproof DC-Sockets**

**Item Code 025318**

12V/24V Socket  
Dims. 60 x 42 x 34mm (lxwxd)  
Input 12V-20A/24V-10A



**Waterproof DC-Sockets**

**Item Code 025320**

USB Socket with 2 Entries  
Input 12-24VDC.  
Output 5V/3.1A (in total)  
Dims. 60 x 42 x 34mm (lxwxd)



**Waterproof DC-Sockets**

**Item Code 025325**

2x USB Socket + 1xVOLT  
Meter (5-30VDC)  
Dims. 60 x106 x 34mm (lxwxd)



**Waterproof DC-Sockets**

**Item Code 025326**

2x 12V Socket (lighter plug)  
12V/20A or 24V/10A  
Dims. 60 x106 x 34mm (lxwxd)



**Waterproof DC-Sockets**

**Item Code 025327**

1x 12V Socket (lighter plug)  
+ 2x USB Socket  
Dims. 60 x106 x 34mm (lxwxd)



**Ignition switches - 3 position**

Position	3 conventional off - run - start (cont.)	3 conventional off - run - start (cont.)	3 magneto off - run - start	3 magneto off - run - start	3 magneto off - run - start (cont.)	3 magneto off - run - start (cont.)
<b>Body</b>	Polyester	Polyester	Polyester	Polyester	Polyester	Polyester
<b>Length</b>	Long: 1 1/8" maximum panel thickness	Short: 5/8" maximum panel thickness	Short: 5/8" maximum panel thickness	Short: 5/8" maximum panel thickness	Short: 5/8" maximum panel thickness	Long: 1 1/8" maximum panel thickness
<b>Terminal type</b>	3 screw tab	3 screw tab	5 screw, 1 boss screw	6 screw	6 color coded wire leads / potted	6 screw tab
<b>Back Up nut</b>	Brass	Brass	Brass	Brass	Brass	Brass
<b>Face nut</b>	Knurled black plastic w/rubber cap	Knurled black plastic w/rubber cap	Hex black plastic face nut	Hex black plastic face nut	Hex black plastic face nut	Hex black plastic face nut
<b>Hole size</b>	7/8"	7/8"	7/8"	7/8"	7/8"	7/8"
<b>Ignition</b>	15 Amp @ 12 VDV	15 Amp @ 12 VDV	15 Amp @ 12 VDV	15 Amp @ 12 VDV	15 Amp @ 12 VDV	15 Amp @ 12 VDV
<b>Solenoid</b>	30 Amp @ 12 VDC	30 Amp @ 12 VDC	30 Amp @ 12 VDC	30 Amp @ 12 VDC	30 Amp @ 12 VDC	30 Amp @ 12 VDC
<b>Choke (push to choke)</b>	-	-	7 Amp @ 12 VDC	7 Amp @ 12 VDC	7 Amp @ 12 VDC	7 Amp @ 12 VDC*
<b>Item Code</b>	<b>64MP39200</b>	<b>64MP41030</b>	<b>64MP39760</b>	<b>64MP41000</b>	<b>64MP41070</b>	<b>64MP39830</b>

\* Terminal to power separately controlled choke unit

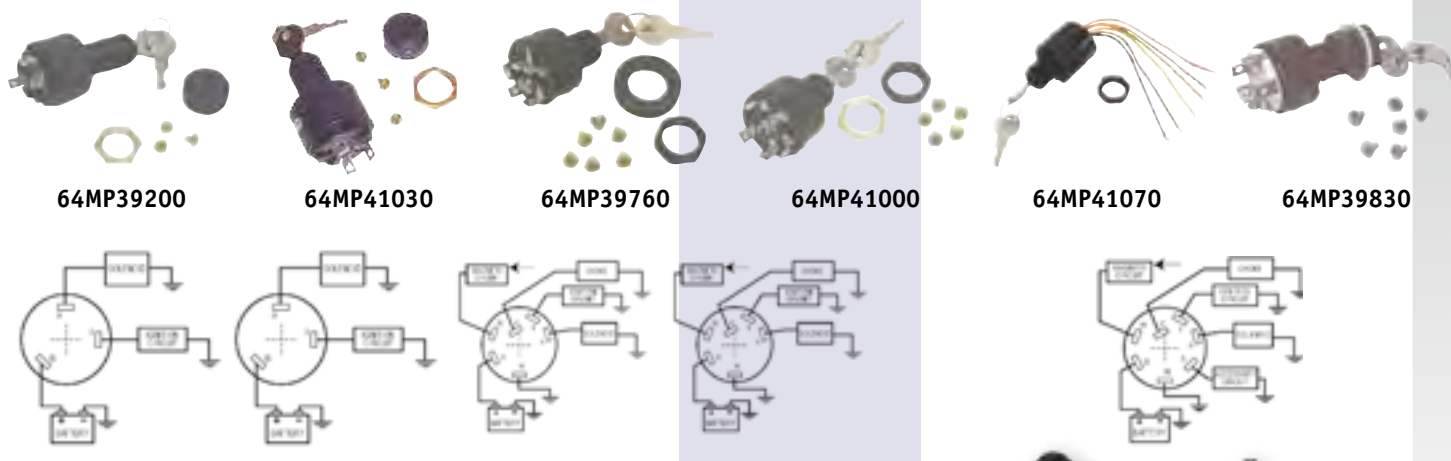

**Item Code N0001338**  
12V / 10A. socket with plug.  
Including cover

**12V Socket with plug**



**Item Code N0001343**  
12-24V, 2 USB ports, 2.1A  
Output Voltage 5V  
Over Voltage protection 6.8V Maximum

**USB plug for 12V socket**



**Item Code 078625**  
Stainless steel illuminated cigaret lighter plug and socket  
A = 53mm, B = 39mm, C = 55mm

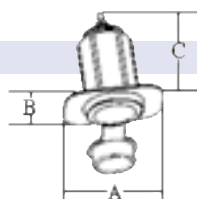

**Illuminated Cigaret lighter plug and socket**





### Circuit Panel 12V with 12V Socket Auto Fuse

#### Item Code L0610226

Black, plastic, 5-position splash proof circuit panel, 12VDC UL-approved switches with LED-indicators  
5A x 2, 10A x 2, 15A x 2 fuses and 12V socket  
Dims. 180x107mm  
Comes with printed function legend labels  
CE-approved



### Circuit Panel 12V with Volt Meter Auto Fuse

#### Item Code L0610225

Black, plastic, 5-position splash proof circuit panel, 12VDC UL-approved switches with LED-indicators  
5A x 2, 10A x 2, 15A x 2 fuses and Volt meter  
Dims. 180x107mm  
Comes with printed function legend labels  
CE-approved



### Circuit Panels 12V with IP66 Rocker Switches Auto Fuse Waterproof

#### Item Code L0611186

Black, ABS, 6-position watertight (IP66) circuit panel, 12VDC UV-resistant removable cover  
UL-approved switches with LED-indicators  
5A x 2, 10A x 2, 15A x 2 fuses  
Dims. 183x90mm. Cut-out size 157x63mm  
Comes with 23 printed function legend labels  
CE-approved



#### Item Code L0611188

Black, ABS, 8-position watertight (IP66) circuit panel, 12VDC UV-resistant removable cover  
UL-approved switches with LED-indicators  
5A x 2, 10A x 3, 15A x 3 fuses  
Dims. 235x90mm. Cut-out size 209x63mm  
Comes with 23 printed function legend labels  
CE-approved



### Circuit Panels 12V with IP66 Rocker Switches Auto Fuse Waterproof

#### Item Code L0611176

Black, ABS, 6-position watertight (IP66) circuit panel, 12VDC UV-resistant removable cover  
UL-approved switches with LED-indicators  
5A x 2, 10A x 2, 15A x 2 fuses  
Dims. 183x120mm. Cut-out size 157x93mm  
Comes with 23 printed function legend labels  
CE-approved



#### Item Code L0611178

Black, ABS, 8-position watertight (IP66) circuit panel, 12VDC UV-resistant removable cover  
UL-approved switches with LED-indicators  
5A x 2, 10A x 3, 15A x 3 fuses  
Dims. 235x120mm. Cut-out size 209x93mm  
Comes with 23 printed function legend labels  
CE-approved

**Item Code 025310**

ABS, 4 Positions, 12V, Splash Proof, Auto Fuse Circuit Panel with LED-Indicators. Dims. 130x100mm (wxh)  
2x5A, 1x10A, 1x15A

Please note: no. 1 position with momentary switch (15A)

**Circuit Panel  
12V  
Auto Fuse**



**Item Code 025315**

ABS, 6 Positions, 12V, Splash Proof, Auto Fuse Circuit Panel with LED-Indicators. Including 12V lighter- & USB-Socket. Dims. 182,5x100mm (wxh)  
3x5A, 2x10A, 1x15A

Please note: no. 1 position with momentary switch (15A)

**Circuit Panel  
12V  
Auto Fuse**



**\*Matching with circuit panels**

**Item Code 025310 & 025315 on page 324**

Splash Proof. Dims. 60x100mm. Cut out size 42 x 81mm (WxH)  
6 Models:

- Item Code 025330** 12V Socket
- Item Code 025331** USB Socket
- Item Code 025332** Lighter Socket
- Item Code 025333** Volt meter
- Item Code 025334** Bilge Pump Switch
- Item Code 025335** Ampère Meter

**Modulair\* Single  
Function Mini  
Switch Panels,  
12V**





**Circuit Panel 12V**

**Item Code L0610044**  
Black plastic 4-position circuit panel, **splash waterproof**.  
Incl. 15A fuses. Dims. 110 x 95mm.  
Comes with 28 printed function legend labels.

**Item Code L0610064**  
Black plastic 6-position circuit panel, **splash waterproof**.  
With LED-indicators. Incl. 15A fuses. Dims. 110 x 124mm.  
Comes with 28 printed function legend labels



**Circuit Panel 12V**

**Item Code L0674044**  
White plastic 4-position circuit panel, **splash waterproof**.  
Incl. 15A fuses. Dims. 110 x 95mm.  
Comes with 28 printed function legend labels.

**Item Code L0674064**  
White plastic 6-position circuit panel, **splash waterproof**.  
With LED-indicators. Incl. 15A fuses. Dims. 110 x 124mm.  
Comes with 28 printed function legend labels.



**Circuit Panel 12V**

**Item Code L0612054**  
Plastic 4-position circuit panel, **splash waterproof**.  
With LED-indicators. Without fuses. Dims. 100 x 110mm.  
Comes with 30 printed function legend labels.

**Item Code L0612056**  
Plastic 6-position circuit panel, **splash waterproof**.  
With LED-indicators. Without fuses. Dims. 100 x 150mm.  
Comes with 30 printed function legend labels.



**Circuit Panel 12V  
Auto Fuse**

**Item Code L0680013**  
Plastic 3-position circuit panel (max 5A), **splash waterproof**.  
With LED-indicators, automatic 5-10-15A fuses.  
Dims. 130 x 110mm. Comes with 30 printed function legend labels.

**Item Code L061013301**  
Replacement switch

**Item Code L0680016**  
Plastic 6-position circuit panel, **splash waterproof**.  
With LED-indicators, automatic 2x5-2x10-2x15A fuses. Dims.  
130 x 190mm. Comes with 30 printed function legend labels.

**Item Code L061013301**  
Replacement switch



**NEW**  
**Sierra  
Circuit Panels**

12-24V, IP66. With LED-indicators and auto. fuses.

**Item Code 64SP21000** 4 Pos. blue Sea #8372

**Item Code 64SP21010** 6 Pos. blue Sea #8371



**NEW**  
**Sierra Touch-S  
Circuit Panels**

11-30V, 10A at 12V, IP67. The functions of the illuminated touch buttons are fully programmable. Built-in Resettable Fuses (PPTC), 60 different labels included. Installation size Ø15mm. Simple assembly due to very low installation depth. The control box can be installed at a maximum distance of 1 meter.

**Item Code 64SP21020** 6 Pos.

**Item Code 64SP21030** 10 Pos.

Black coated aluminum panel. Complete with 5A Glass fuses. Lighted switches and function legends printed on adhesives. Incl. fastening material.

**Item Code 078270** Dims. 125x115mm, 4 Positions

**Item Code 078271** Dims. 165x115mm, 6 Positions

### 12V DC Circuit Panels



Black coated panel with automatic fuses: 2x3A, 2x6A, 1x8A and 1x10A

**Item Code 078275** Dims. 165x115mm, 6 Positions

### 12V DC Circuit Panels



Black coated aluminum panels. **Weatherproof.** With 5A glass fuses and indicator lights.

Item Code	Positions	A mm	B mm
078615	3	102	100
078616	4	125	100
078617	6	170	100
078627	Spare Fuse holder (without fuse)		

### 12V DC Circuit Panels

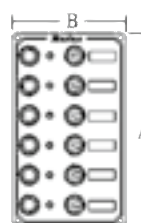

078627



**Item Code L0610037**

Aluminum 3-position circuit panel. UL-approved. **Splash waterproof.** With LED-indicators, 15A glass fuses. Dims. 133 x 95mm. Comes with 30 printed function legend labels

### Circuit Panel 12V Waterproof



**Item Code L0610067**

Aluminum 6-position circuit panel. UL-approved. **Splash waterproof.** With LED-indicators, 15A glass fuses. Dims. 133 x 190mm. Comes with 30 printed function legend labels

### Circuit Panel 12V Waterproof



**Item Code L0610247**

Aluminum 8-position **waterproof** circuit panel. UL-approved. With LED-indicators and 15A glass fuses. Dims. 240 x 95mm. Comes with 30 printed function legend labels.

### Circuit Panel 12V Waterproof



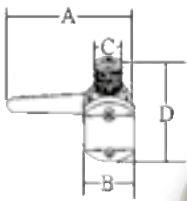

**Adjustable  
Antenna Base**

Guard rail mount Ø20-25mm, Ratchet bracket easy adjustable, Available in stainless steel or plastic, Fits any standard antenna  
Stainless Steel Dims.:

A = 116mm, B = 49mm, C = 25mm, D = 87mm

Plastic Dims.:

A = 110mm, B = 44mm, C = 25mm, D = 70mm

**Item Code 078560** Stainless Steel

**Item Code 078565** Plastic



**Fixed Antenna  
Base**

Available in stainless steel and plastic Fits any standard antenna

*stainless steel*  
**316**

**Item Code 078550** Stainless Steel

**Item Code 078551** Plastic

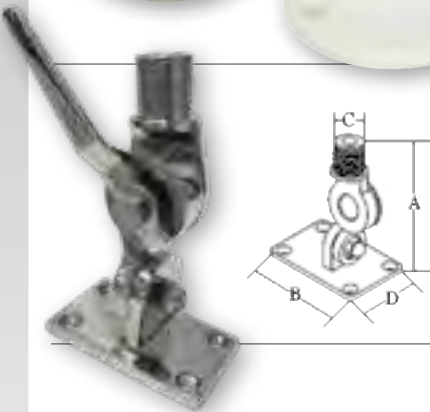

**Adjustable  
Antenna Base**

Deck mount Ratchet bracket easy adjustable Stainless steel

**Item Code 078555** Fits any standard antenna

A = 138mm, B = 92mm, C = 25mm, D = 52mm



**Radio Cover**

**Item Code 089200**

Flush Mount Radio Cover. Smoke colored spring loaded fold-up door is pushed inside the housing. Base color is black. UV-Resistant.

Dims.: 233 x 107 x 85mm (lxhxd)



**Radio Cover**

**Item Code 024345**

Flush Mount Radio Cover. Smoke colored spring loaded fold-up door. Base color is white. Mounting gasket included. UV-Resistant.

Dims.: 229 x 104 x 50mm (lxhxd)



**Radio Cover**

**Item Code 024346**

Flush Mount Radio Cover. Smoke colored spring loaded fold-up door is pushed inside the housing. Base color is white. Mounting gasket included. UV-Resistant.

Dims.: 241 x 102 x 25 (114)mm (lxhxd)





LED lighted LCD display with High Resolution, Output: **4X40W**

Technical data:

- Bluetooth Function
- MP3
- USB Input
- AUX Input
- RCA Output
- Radio AM/FM
- Clock
- Protection: IP66
- Ø built-in: 80mm, Ø outside: 105mm, built-in depth: 41mm



### allpa® waterdichte marine radio



**Item Code 025100** Radio

**Item Code 025105** USB/AUX Connector. (USB = Load and play)

Waterproof 200W Loudspeaker Set

- Protection : IP67
- Power: 200W
- Impedance: 4Ω
- Frequency: 85Hz-18kHz
- Sensitivity: 91dB ± 2dB
- Diameter: Ø190mm
- Bore: Ø140mm
- Built-in depth: 65mm
- Plastic body and grill
- Seawater and UV-resistant
- 2-Way system with tweeter



### allpa® Loudspeaker Set 200W with tweeter



**Item Code 035400** Set of 2 speakers 200W, color white

**Item Code 035410** Set of 2 speakers 200W, color black

Waterproof 60W or 100W Loudspeaker Sets

- Protection : IP67
- Power: 60W or 100W
- Impedance: 4Ω
- Frequency: 85Hz-18kHz (60Hz-18kHz for 100W)
- Sensitivity: 91dB ± 2dB
- Diameter: Ø150mm (Ø165mm for 100W)
- Bore: Ø120mm (Ø150mm for 100W)
- Built-in depth: 50mm (63mm for 100W)
- Plastic body and grill
- Seawater and UV-resistant

### allpa® Loudspeaker Sets 60W & 100W



**Item Code 078655** Set of 2 speakers 60W, color white

**Item Code 078654** Set of 2 speakers 60W, color black

**Item Code 078656** Set of 2 speakers 100W, color white

Waterproof antenne

150mm cable  
320x35x15mm

### allpa® Radio Antenna



**Item Code 025140**



**Dome Lights with ribbed lens**

Available in brass or stainless steel

Item Code	Model	A mm	B mm	
078361	3"	110	70	12V 8W, Stainless Steel
078580	4"	140	98	12V 15W, Stainless Steel
078581	5"	170	115	12V 15W, Stainless Steel
078363	3"	110	70	12V 8W, Brass
078362	4"	140	98	12V 15W, Brass
078364	5"	170	115	12V 15W, Brass



**Brass Dome Light**

With teak base and ribbed lens

Item Code	Model	A mm	B mm	
078600	4"	145	98	12V 15W
078601	5"	158	115	12V 15W

Weight 260gr



**Reading Lamp**

**Item Code 078365**

Varnished Brass, with switch  
Base Ø76mm, 12V-10W



**Cabin Glow Lamp**

**Item Code 078367**

Brass with switch  
Base Ø76mm, 12V-10W



**Chart Light**

**Item Code 078366**

Flexible Chart Light, brass. With switch. Wall mount.  
Halogen 12V/10W - G4.  
Dims: L=373mm, base 92 x 59mm, lamp body Ø30mm.

**Item Code 078368**

Flexible Chart Light, brass. With switch. Wall mount.  
Halogen 12V/10W - MR16.  
Dims: L=383mm, base 54 x 46mm, lamp body Ø53mm.



**Cabin Glow Lamp**

**Item Code 078356**

Ø Base = 70mm. Height = 175mm,  
Ø Glass= 90mm



**Adjustable Halogen Reading Light**

12V/10W, incl. schakelaar.  
70x38mm (base)x54mm deep.

<b>Item Code L4400942</b>	Brass, Varnished
<b>Item Code L4400943</b>	Chrome

# LED

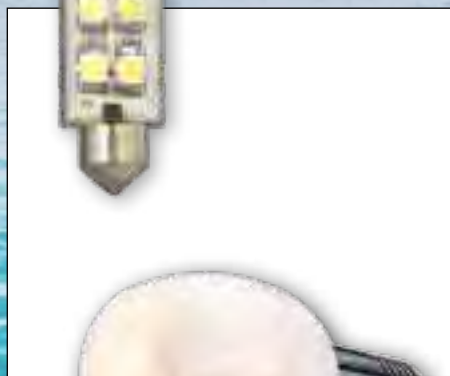
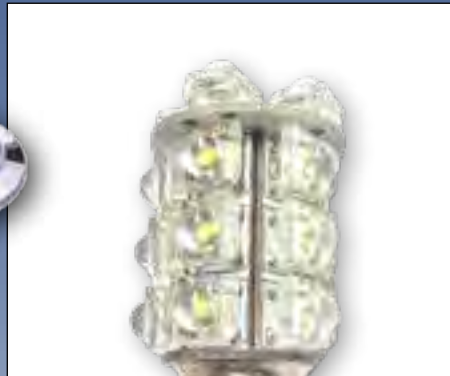
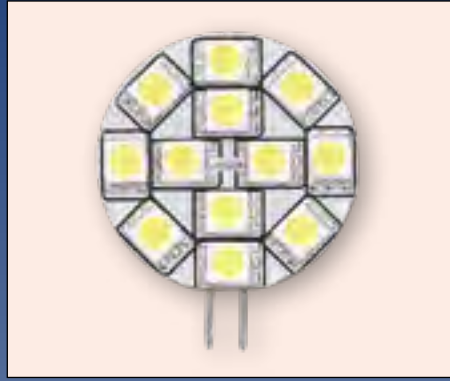

**allpa**  
marine equipment





### BA15D 25W

**Item Code L8000825**

BA15D 25W LongLife replacement bulb for navigation lights



### BA15D

**Item Code L8000803**

BA15D 12V / 3W replacement bulbs,  
sale per 10 units

**Item Code L8000810**

BA15D 12V / 10W replacement bulbs,  
sale per 10 units

**Item Code L8000815**

BA15D 12V / 15W replacement bulbs,  
sale per 10 units



### MR16 Halogen

**Item Code L8000910**

12V / 10W MR16 Halogen

Color temperature: 2800-3000K, warm white, dimmable

LED 6 x 0,3W, 10-30V/1,8W. Ø23mm  
Luminance: 70LM. Similar to 15W light bulb. Beam 120°

**Item Code L8000014** G4, Side Pin

**Item Code L8000015** G4, Back Pin

LED 12 x 0,2W, 10-30V/2,5W. Ø31mm

Luminance: 120LM. Similar to 20W light bulb. Beam 120°

**Item Code L8000016** G4, Side Pin

**Item Code L8000017** G4, Back Pin

**LED Bulb G4**



LED

Conversion socket for LED G4 lights

**Item Code L8000051** BA15D to G4

**Item Code L8000050** BAY15D to G4

**Conversion socket  
Bayonet to G4**



LED

**Item Code L8000111**

Made of aluminum, clear lens  
1 x 1W high power LED, 12VDC  
Dims. Ø34,5mm, L=38mm

**LED Bulb MR11**



LED

Color temperature: 2800-3000K, warm white, dimmable

**Item Code L8000116**

LED 4 x 1W, 12VDC. Similar to 10-15W light bulb

**Item Code L8000117**

LED 12 x Ø5mm, 12VDC. Similar to 20W light bulb

**LED Bulb MR16**



LED

**Item Code L4401162**

LED **BA15D** (10-30V, 2.5W) Replacement bulb for cabin light  
Dims. Ø19mm, H=43mm. Warm White

**Item Code L4401172**

LED **BA15D** (10-30V, 2.5W) Replacement bulb for cabin light  
Silicon protection, 6000K  
Dims. Ø15mm, H=53,5mm. Cool White

**Item Code L4401164**

LED **BAY15D** (10-30V, 2.5W) Replacement bulb for Navigation light  
Replaces 25W bulbs (not BSH-approved)  
Dims. Ø26,5mm, H=55,5mm

**LED Bulb BA15D  
for interior**

**LED Bulb BAY15D  
for navigation**



LED

12V LED bulb

No. of LED's:	Power:	Dimensions:	Color:	Item Code:
1	0,5W	30 x 10mm	Warm White	L8000005
2	0,98W	38 x 10mm	Warm White	L8000006
3	0,5W	42 x 12mm	Warm White	L8000009
6	0,5W	42 x 12mm	Warm White	L8000010

**LED Bulb  
Festoon Type**



LED



LED



**LED Dome Light**

Incl. switch

**Item Code L4400534** LED Dome Light, varnished brass

**Item Code L4400535** LED Dome Light, Stainless Steel A304

Voltage: 12V  
 Beam: 15°  
 Colour temperature: 5500-6300K, Cool White  
 Lumen: 260lm  
 Wattage: 3,6W  
 Protection: **IP65**

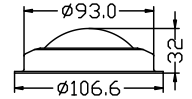

LED



**LED Dome Light**

Incl. switch

**Item Code L4400544** LED Dome Light, varnished brass

**Item Code L4400545** LED Dome Light, Stainless Steel A304

Voltage: 12V  
 Beam: 15°  
 Colour temperature: 5500-6300K, Cool White  
 Lumen: 272lm  
 Wattage: 3,7W  
 Protection: **IP65**

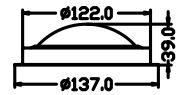

LED



**LED Dome Light**

**Item Code L4400556**

LED Dome Light, gold plated plastic

Incl. switch. Splash proof

Voltage: 12V  
 Beam: 15°  
 Colour temperature: 2850-3200K, Warm White  
 Wattage: 1,7W

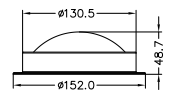

LED



**LED Ceiling Light**

**Item Code L4400520**

Chrome plated brass, incl. switch

Voltage: 12V  
 Beam: 120°  
 Colour temperature: 2800-3000K, Warm White  
 Wattage: 6 x 0,3W  
 Dimensions:  
 Diameter: 98mm  
 Height: 36mm



LED



**LED Ceiling Light**

**Item Code L4400546**

LED Dome Light, plastic housing with aluminum base

Incl. switch. Splash proof

Voltage: 12V  
 Beam: 120°  
 Colour temperature: 2850-3200K, Warm White  
 Wattage: 1W

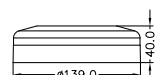

**Item Code L4400601**

Stainless Steel A304  
 Splash proof

Voltage: 12V  
 Beam: 120°  
 Colour temperature: 2850-3200K, Warm White  
 Wattage: 1W

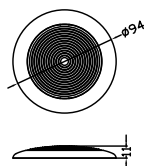

**LED Dome Light**



**LED**

**Item Code L4400602**

Stainless Steel A304  
 Splash proof

Voltage: 12V  
 Beam: 120°  
 Colour temperature: 2850-3200K, Warm White  
 Wattage: 2,26W

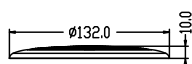

**LED Dome Light**



**LED**

**Item Code L4400554**

Stainless Steel A304  
 Incl. switch. Splash proof  
 Not dimmable

Voltage: 12V  
 Beam: 110°  
 Colour temperature: 2850-3200K, Warm White  
 LED Type: High Power LED 1 x 3W  
 Wattage: 3,1W

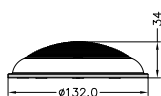

**LED Dome Light**



**LED**

**Item Code L4400701**

Stainless Steel A304  
 Suitable for OEM. Dimmable (NON-PWM signal - Steady Volt)

Voltage: 12V  
 Beam: 120°  
 Colour temperature: 2850-3200K, Warm White  
 LED Type: LED 0,5W (Samsung 5630)  
 Protection: **IP65**

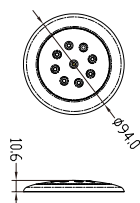

**LED Dome Light  
 complies with  
 BS EN60945**



**LED**



LED

**Built-on LED Dome Light**



<b>Item Code L1900251</b>	Ø50mm
<b>Item Code L1900252</b>	Ø70mm
<b>Item Code L1900253</b>	Ø105mm met touch switch

Voltage:	10-30V
Material:	Chromed aluminium, frosted lens
Colour temperature:	3000K
LED Type:	15x Warm White LED 4014 27x Warm White LED 4014 42x Warm White LED 4014
Wattage:	3W, 6W, 6.3A/430lm
Height:	7.5mm
Protection:	<b>IP65</b>

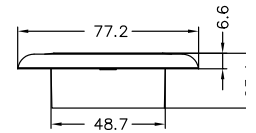

LED

**LED Dome Light dimmable**



<b>Item Code L1900262</b>	Ø105mm with dimmable touch switch
Voltage:	10-30V
Material:	Chromed aluminium, frosted lens
Switch:	Dimmable touch switch
Colour temperature:	2800-3200K
LED Type:	42x Warm White LED 4014
Wattage:	6W
Dimensions:	Diameter: Ø105mm Height: 7.5mm
Protection:	<b>IP20</b>



LED

**LED Dome Light dimmable**



<b>Item Code L1900263</b>	Ø74mm with dimmable touch switch
Voltage:	10-30V
Material:	White Plastic
Switch:	Dimmable touch switch
Colour temperature:	2800-3200K
LED Type:	30x Warm White LED 4014
Wattage:	3W
Height:	11mm
Protection:	<b>IP20</b>



LED

**LED Dome Light**

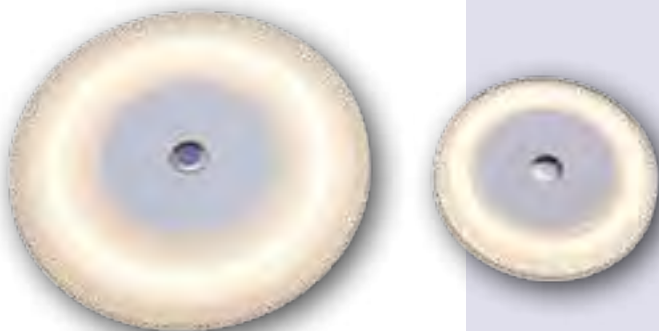

<b>Item Code L1900273</b>	Ø74mm with dimmable touch switch
<b>Item Code L1900274</b>	Ø120mm with dimmable touch switch

Voltage:	10-30V
Material:	Aluminium, Plastic
Switch:	Touch switch
Colour temperature:	2800-3200K
LED Type:	30x Warm White LED 42x Warm White LED
Wattage:	3W, 6W
Protection:	<b>IP20</b>

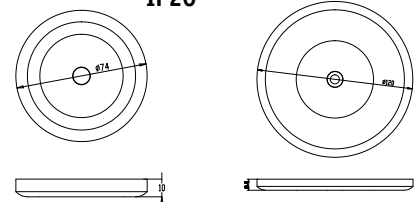



**Item Code L1900260** Ø93mm  
**Item Code L1900261** Ø115mm

Voltage: 10-30V  
 Material: Chromed aluminium, frosted lens  
 Colour temperature: 2800-3200K  
 LED Type: 21x SMD 2835 warm White LED  
 27x SMD 2835 warm White LED  
 Wattage: 2W, 4W  
 Protection: **IP60**

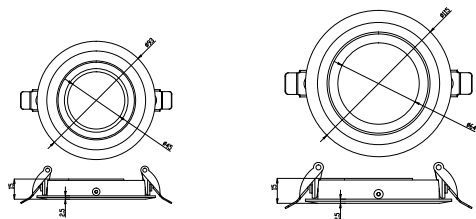

**LED Dome Light**

**LED**



**Item Code L1900265** Ø69.5 mm

Voltage: 10-24V  
 Material: Aluminium  
 Colour temperature: 3000K  
 LED Type: 18x warm White LED 2835  
 Wattage: 3W  
 Protection: **IP65**



**LED Dome Light**

**LED**



**Item Code L1900266** Ø55 mm

Voltage: 12V  
 Material: Aluminium  
 Colour temperature: 3000K  
 LED Type: 9x warm White LED 3535  
 Wattage: 3W  
 Protection: **IP65**

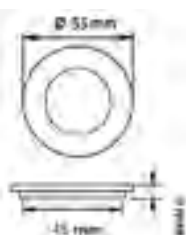

**LED Dome Light**

**LED**



**Item code L4400229** Ø40 mm

Voltage: 8-30V  
 Material: Aluminium  
 Beam: 110°  
 Colour temperature: 2900-3200K  
 LED Type: Warm White LED  
 Wattage: 1.2W  
 Diameter: Ø40mm (+ clamps)

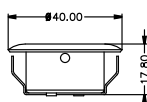

**LED mini Dome Light**

**LED**





LED

**LED Ceiling Light**

Dimmable.

Item Code	Model	Switch
L4400249	Brass Plated	x
L4400250	Brass Plated	yes
L4400251	Chrome Plated	x
L4400252	Chrome Plated	yes

Voltage: 12-24V  
 Material: Plastic housing  
 Beam: 120°  
 Colour temperature: 2800-3000K Warm White  
 Wattage: 1.8W

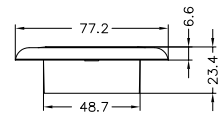

LED



**LED Ceiling Light  
Complies with  
BS EN60945**

**Item Code L4400658**  
 LED Ceiling Light, White polycarbonate housing  
 Suitable for OEM. Dimmable (NON-PWM signal - Steady Volt)

Voltage: 12V  
 Beam: 120°  
 Colour temperature: 2900-3200K, Warm White  
 Wattage: 2,20W  
 Protection: **IP67**

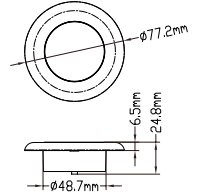

LED



**LED Ceiling Light  
complies with  
BS EN60945**

**Item Code L4400604**  
 LED Ceiling Light, plastic housing with Stainless Steel A304  
 Trim Ring Suitable for OEM. Dimmable (NON-PWM signal -  
 Steady Volt)

Voltage: 12V  
 Beam: 120°  
 Colour temperature: 2850-3200K, Warm White  
 Wattage: 7,5W  
 Protection: **IP67**

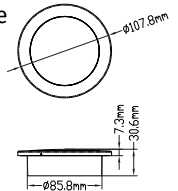

LED



**LED Ceiling Light  
complies with  
BS EN60945**

**Item Code L4400605**  
 LED Ceiling Light, plastic housing with Stainless Steel A304  
 Trim Ring Suitable for OEM. Dimmable (NON-PWM signal -  
 Steady Volt)

Voltage: 12V  
 Beam: 120°  
 Colour temperature: 2850-3200K, Warm White  
 Wattage: 9,3W  
 Protection: **IP67**

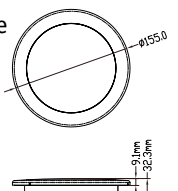

**Item Code L4400190**

LED Ceiling Light, aluminum housing  
 Splash proof

Voltage: 12V  
 Beam: 140°  
 Colour temperature: 2850-3200K, Warm White  
 Wattage: 3,1W

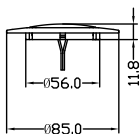

**LED Ceiling Light  
 Super Flat**



**Item Code L4400290**

LED Ceiling Light, aluminum housing Suitable for OEM.  
 Dimmable (NON-PWM signal - Steady Volt)  
 Splash proof

Voltage: 12V  
 Beam: 120°  
 Colour temperature: 2900-3200K, Warm White  
 Wattage: 1W

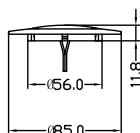

**LED Ceiling Light  
 Complies with  
 BS EN60945  
 Super Flat**



**Item Code L4400607**

LED Ceiling Light, polycarbonate housing Suitable for OEM.  
 Dimmable (NON-PWM signal - Steady Volt)

Voltage: 12V  
 Beam: 120°  
 Colour temperature: 2900-3200K, Warm White  
 LED Type: LED 5Ø x 5 (Samsung 5630)  
 Wattage: 2W  
 Protection: **IP67**

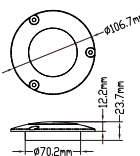

**LED Ceiling Light  
 complies with  
 BS EN60945**



**Item Code L4400615**

LED Ceiling Light, plastic housing with Stainless Steel A304  
 Trim Ring Suitable for OEM. Dimmable (NON-PWM signal -  
 Steady Volt) Incl. touch switch + Dimmer Combo  
 Splash proof

Voltage: 12-24V  
 Beam: 120°  
 Colour temperature: 2850-3200K, Warm White  
 Wattage: 3W  
 Protection: **IP67**

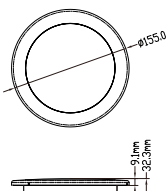

**LED Ceiling Light  
 complies with  
 BS EN60945**





LED



**LED Interior Light**

**Item Code L4401804**

LED Light, ABS housing  
Incl. switch. Splash proof

Voltage: 12-24V  
Beam: 120°  
Colour temperature: 2700-3200K, Warm White  
Wattage: 7W  
Dimensions: (lxwxh): 400x78x30mm



LED



**LED Interior Light**

**Item Code L4401190**

LED Interior Light, polycarbonate housing  
Incl. switch. Splash proof  
360° Eye-Balled Rotation Revolving Light.

Voltage: 9-30V  
Colour temperature: Warm White  
Wattage: 1W  
Protection: **IP67**

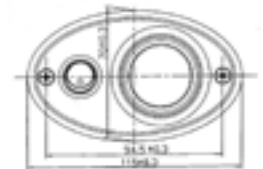

LED



**LED Interior Light**

**Item Code L4401193**

LED Interior Light, aluminum housing  
Incl. switch. Splash proof  
360° Eye-Balled Rotation Revolving Light.

Voltage: 12V  
Colour temperature: Warm White  
Wattage: 0.5W

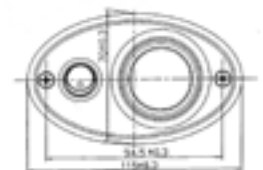

**Dimmer 12-24V**

Range 12V-30VDC, max. 120W  
Dims. 61x61x15mm (lxwxh)  
The dimmer will cut off the light in case of:  
The load exceeds 120W  
In 12V-system: Voltage < 9V or >15V  
In 24V-system: Voltage <19V or >31V  
The LED next to "+" or "-" key will flash depending on the above situations.  
**Not suitable for High Power LED's**

**Item Code L4401160** Dimmer, plastic housing

**Item Code L1900297** Lumen 180LM Cool White with stainless steel ring and 1.5M cable  
**Item Code L1900298** Lumen 20LM Blue with stainless steel ring and 1.5M cable

Mounting: Surface mount  
 Voltage: 12V  
 Material: Plastic polymer with stainless steel ring  
 Beam: 120°  
 Colour temperature: 4500K  
 LED Type: 12 x 0.2W "2835" LED  
 Wattage: 2.3W  
 Protection: **IP68**  
 Dimensions: Length: 85.1mm  
 With: 40.1mm  
 Height: 18mm

**LED Underwater Light**



**Item Code L4400297** Lumen 372LM 4x Cool White with Stainless steel body and 1.5M cable  
**Item Code L1901298** Lumen 68LM 4x Blue with Stainless steel body and 1.5M cable  
**Item Code L4400298** Lumen 670LM 6x Cool White with Stainless steel body and 1.5M cable  
**Item Code L1901299** Lumen 156LM 6x Blue with Stainless steel body and 1.5M cable  
**Item Code L4400299/D** Driver for allpa LED Underwater lighting L4400298/99

**LED Underwater Light**



Mounting: Surface mount  
 Voltage: 10-30V  
 Material: S.S. 316 body  
 Beam: 120°  
 Colour temperature: 5500-6300K  
 LED Type: 4 x 3W "2835" LED  
 6 x 3W "2835" LED  
 Wattage: 10W and 14.2W  
 Protection: **IP68**  
 Dimensions: L=137.5mm, W=68mm, H= 24mm

**Item Code L4400299** Lumen 5602LM Cool White with Stainless steel body and 1.5M cable  
**Item Code L1900299** Lumen 188LM Blue with Stainless steel body and 1.5M cable  
**Item Code L4400299/D** Driver for allpa LED Underwater lighting L4400298/99

**LED Underwater Light**



Mounting: Surface mount  
 Voltage: 10-30V  
 Material: S.S. 316 body  
 Beam: 120°  
 Colour temperature: 5500-6300K  
 LED Type: 6 x 3W "2835" LED  
 Wattage: 14.2W  
 Protection: **IP68**  
 Dimensions: Diameter: Ø 94mm, H=21mm

**Item Code L1900307** Cool White  
**Item Code L1900308** Blue

Voltage: 10-30V  
 Material: Brass  
 LED Type: 1x 7W Daylight  
 White of Blue LED  
 Protection: **IP68**  
 Dimensions: ½" NPT screw thread

**LED (drain) plug Underwater Lighting**

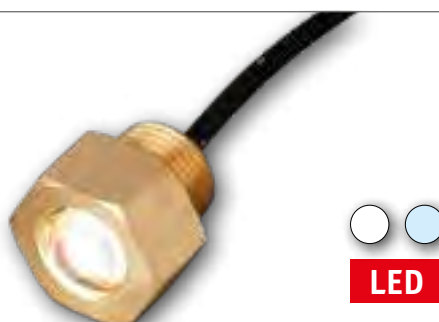



LED

### LED Flexible Chart Light

**Item Code L4401324**

Incl. switch

Voltage: 8-30VDC  
 Material: Chrome Plated Brass  
 Beam: 110°  
 Colour temperature: 2850-3200K, Warm White  
 Wattage: 1,2W  
 Dimensions: Base Ø50mm  
 Lamp Ø30mm  
 L = 416mm



LED

### LED Flexible Chart Light

**Item Code L4401325**

Incl. switch

Voltage: 8-30VDC  
 Material: Chrome Plated Brass  
 Beam: 110°  
 Colour temperature: 2850-3200K, Warm White  
 Wattage: 1,2W  
 Dimensions: Base Ø50mm  
 Lamp Ø30mm  
 L = 416mm



LED

### LED Flexible Chart Light

**Item Code L4401326**

Incl. switch

Voltage: 8-30VDC  
 Material: Chrome Plated Brass  
 Beam: 110°  
 Colour temperature: 2850-3200K, Warm White  
 Wattage: 1,2W  
 Dimensions: Base Ø50mm  
 Lamp Ø36mm  
 L = 416mm

**Item Code L1900018** Reading-Wall light with dimmable Touch switch  
 Voltage: 10-30V  
 Material: Chromed Aluminium, glass lens  
 Type Switch: Dimmable Touch switch  
 Colour temperature: 2800-3200K  
 LED Type: 1x warm White LED  
 Wattage: 3W  
 Dimensions: Ø base: 65mm, Ø hood: 60mm, depth: 97mm, height: 104mm

**LED reading - Wall Light Dimmable**



LED

**Item Code L1900017** Reading-Wall light with dimmable Touch switch  
 Voltage: 10-30V  
 Material: Chromed Aluminium, glass lens  
 Type Switch: Dimmable Touch switch  
 Colour temperature: 2800-3200K  
 LED Type: 1x warm White LED  
 Wattage: 3W  
 Dimensions: Ø base: 65mm, Ø hood: 55mm, depth: 78mm, height: 101mm

**LED reading - Wall Light Dimmable**



LED

**Item Code L1900019** Reading-Wall light with dimmable Touch switch  
 Voltage: 10-30V  
 Material: Brushed aluminium, nickel-plated  
 Type Switch: Dimmable Touch switch  
 Colour temperature: 2800-3200K  
 LED Type: 1x warm White LED  
 Wattage: 1W  
 Dimensions: Ø base: 65mm, Ø hood: 32mm, depth: 60mm, height: 88mm

**LED reading - Wall Light Dimmable**



LED

**Item Code L4400926** Varnished brass dimmable with external switch  
 Voltage: 8-30V  
 LED type: 1x warm White LED  
 Wattage: 3W dimmable  
 Dimensions: Ø base: 65mm, Ø hood: 64,5mm height: 153mm

**LED Swivel Reading/Wall Light**



LED

**Item Code L4400936** Chrome plated brass dimmable with external switch  
 Voltage: 8-30V  
 LED type: 1x warm White LED  
 Wattage: 3W dimmable  
 Dimensions: Ø base: 65mm, Ø hood: 64,5mm height: 153mm



LED

**LED Swivel Mini Reading/Wall Light**

<b>Item Code L4400002</b>	Varnished brass
Incl. switch	
Voltage:	8-30V
LED Type:	1x Warm White light LED
Wattage:	1W
Dimensions:	Ø base: 40mm, Ø hood: 30mm height: 84mm
<b>Item Code L4400012</b>	Chromed brass
Incl. switch	
Voltage:	8-30V
LED Type:	1x Warm White light LED
Wattage:	1W
Dimensions:	Ø base: 40mm, Ø hood: 30mm height: 84mm



LED

**LED Swivel Mini Reading/Wall Light**

<b>Item Code L4400821</b>	Varnished brass
Incl. switch	
Voltage:	8-30V
LED Type:	1x Warm White light LED
Wattage:	3W Dimmable
Dimensions:	Ø base: 54mm, Ø hood: 42mm height: 112mm
<b>Item Code L4400841</b>	Stainless 304
Incl. switch	
Voltage:	8-30V
LED Type:	1x Warm White light LED
Wattage:	3W Dimmable
Dimensions:	Ø base: 54mm, Ø hood: 42mm height: 112mm

LED



**Stainless steel LED reading - Wall Light Dimmable**

<b>Item Code L1900014</b>	Stainless steel LED reading - Wall Light Dimmable
Voltage:	10-30V
Material:	Stainless steel body, glass lens
Type Switch:	dimmable Touch switch
Colour temperature:	3000K
LED Type:	1x warm White LED
Wattage:	3W
Protection:	<b>IP20</b>
Dimensions:	Ø base: 40, height: 90mm

LED



**Stainless steel LED reading - Wall Light**

<b>Item Code L1900015</b>	Stainless steel LED reading - Wall Light
Voltage:	10-30V
Material:	Stainless steel body, glass lens
Type Switch:	Touch switch
Colour temperature:	3000K
LED Type:	1x warm White LED
Wattage:	3W
Protection:	<b>IP20</b>
Dimensions:	Ø base: 65mm, height: 106mm



**Item Code L4400001** LED Mini Reading Light, Varnished brass

**Item Code L4400010** LED Mini Reading Light, Chromed brass

LED 1 x 1W, 50.000 hours, 8-30VDC/1,2W  
 Color temperature: 2850-3500K, Warm White. Beam 110°  
 Luminance 80LM

Dimensions: Base Ø40mm  
 Lamp Ø30mm  
 H = 84mm (upright)

**LED Swivel Mini Reading Light**



**Item Code L4400922** LED Reading Light, varnished brass

**Item Code L4400923** LED Reading Light, stainless steel 304

LED MR16-3.1W (16 x 0.2W) 50.000 uur, 12V  
 Color temperature: 2850-3200K, Warm White. Beam 30°  
 Incl. switch

Dimensions: Base Ø65mm  
 Lamp Ø53mm  
 H = 109mm

**LED Swivel Reading Light**



**Item Code L4400812** LED Mini Reading Light, varnished brass

**Item Code L4400832** LED Mini Reading Light, Stainless 304

LED 2 x 1W, 50.000 hours, 8-30VDC/2,1W  
 Color temperature: 2850-3200K, Warm White. Beam 110°  
 Incl. switch

Dimensions: Base Ø54mm  
 Lamp Ø32mm  
 L = 73mm

**LED Wall Light**



Range 12V-30VDC, max. 120W  
 Dims. 61x61x15mm (lxwxh)  
 The dimmer will cut off the light in case of:  
 The load exceeds 120W

- In 12V-system: Voltage < 9V or >15V
- In 24V-system: Voltage <19V or >31V
- The LED next to "+" or "-" key will flash depending on the above situations.

Not suitable for High Power LED's

**Item Code L4401160** Dimmer, plastic housing

**Dimmer 12-24V**



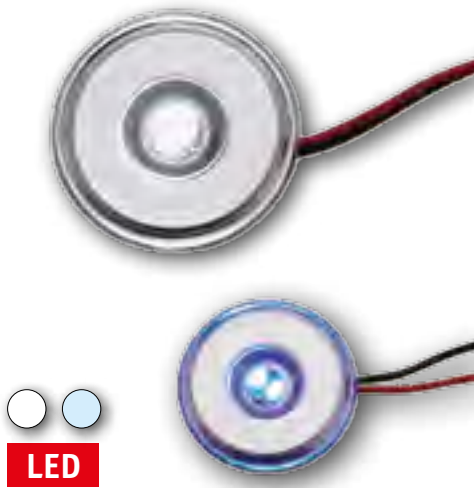

**LED Courtesy light**

**Item Code L1902061** White  
**Item Code L1902062** Blue

Voltage: 12V  
 Material: Plastic  
 Colour temperature: 6300K  
 LED Type: 2 x 0.2W SMD 2835 LED  
 Dimensions: Diameter: Ø39mm  
 Cut out depth: 11mm  
 Cut out diameter: Ø19mm



**LED Courtesy light**

**Item Code L1902162** Courtesy light with stainless steel ring White  
**Item Code L1902163** Courtesy light with stainless steel ring Blue  
**Item Code L1902164** Courtesy light with stainless steel moon White  
**Item Code L1902165** Courtesy light with stainless steel moon Blue

Voltage: 12V  
 Material: Plastic and stainless steel 316  
 Colour temperature: 6300K  
 LED Type: 2 x 0.2W SMD 2835 LED  
 Wattage: 0.4W  
 Dimensions: Length: 53.4mm, height: 33mm, Cut out depth: 28mm, cut out: Ø22mm



**LED Courtesy Light**

LED 1 x 5Ø, 50.000 hours, 12VDC/0,24W  
 Color temperature: 5500-6300K, Cool White. Beam 30°  
 Dims.: 30x30mm (lxw), Ø17,6mm cut out (square)  
 Dims.: Ø32mm, Ø17,6mm cut out (round)  
 Splash proof

**Item Code L4400185** LED Courtesy Light, square  
**Item Code L4400186** LED Courtesy Light, round



**LED Courtesy Light**

LED 1 x 5Ø, 50.000 hours, 12VDC/0,21W  
 Color temperature: 5500-6300K, Cool White. Beam 30°  
 Dims.: 45x32x20,6mm (lxwxh)

**Item Code L4400189** LED Courtesy Light, polycarbonate housing



**LED Interior Light**

LED 1 x 3W, 50.000 hours, 8-30VDC/2,88W  
 Color temperature: 2850-3200K, Warm White. Beam 110°  
 Dims.: Ø128mm, H=29,5mm. Surface mount  
 Luminance 73,5LM  
 Splash proof

**Item Code L4400600** LED Interior Light, plastic housing

LED 5 x TOP 3528, 50.000 hours, 12VDC/0,4W  
 Color temperature: 5500-6300K, Cool White. Beam 120°  
 Dims.: 80x18x16mm (lxwxh), surface mount  
 Luminance 9,5LM, Splash proof

**Item Code L4400181** LED Courtesy Light,  
 Chrome Plated Zinc Alloy

LED  
 Courtesy Light



LED

LED 4 x 5Ø, 50.000 hours, 12VDC/0,38W  
 Color temperature: 5500-6300K, Cool White.  
 Beam 30° (Red Beam 35°)  
 Dims.: 72,5x38x27mm (lxwxh), flush mount  
 Luminance 9,5LM  
 Protection: IP67  
 Plastic Housing with Chrome Bezel

**Item Code L4400169** LED Courtesy Light , Red

LED  
 Courtesy Light



LED

LED 2 x 5Ø, 50.000 hours, 12VDC/0,21W  
 Color temperature: 5500-6300K, Cool White. Beam 30°  
 Dims.: 84x29x20mm (lxwxh), flush mount  
 Luminance 3,6LM  
 Protection: IP67

**Item Code L4400159** LED Courtesy Light,  
 Polycarbonate housing

LED  
 Courtesy Light



LED

LED 2 x 5Ø, 50.000 hours, 12VDC/0,21W  
 Color temperature: 5500-6300K, Cool White. Beam 30°  
 Dims.: 86x31x21mm (lxwxh), flush mount  
 Luminance 3,6LM  
 Protection: IP67

**Item Code L4400160** LED Courtesy Light, Polycarbonate  
 housing with Stainless Steel A304 Rim

LED  
 Courtesy Light



LED

LED 4 x FLAT TOP 3528, 50.000 hours, 12VDC/0,48W  
 Color temperature: 4000-4500K, Warm White. Beam 120°  
 Dims.: 83x20x8mm (lxwxh)  
 Luminance 9,5LM  
 Splash proof

**Item Code L4400184** LED Courtesy Light, Zinc Alloy Body

LED  
 Step Light



LED



LED

**LED Courtesy Light**

**Item Code L4400260** Plastic housing  
LED 2 x 5Ø, 50.000 hours, 12VDC/0,23W  
Color temperature: 5500-6300K, Cool White.  
Beam 30°  
Splash proof

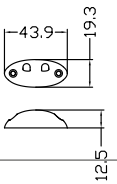

LED

**LED Ceiling Light**

**Item Code L4400230** Anodized Aluminum Housing  
LED 3W x 1, 50.000 uur, 12VDC/3,1W  
Color temperature: 2850-3200K, Warm White.  
Beam 110°, Splash proof

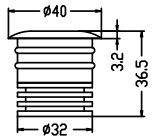

LED



**LED Courtesy Light**

**Item Code L4400162** Plastic housing LED  
1 x 5Ø, 50.000 hours, 12VDC/0,21W  
Color temperature: 5500-6300K, Cool White. Beam 30-35°  
Dims.: Ø38mm, Ø21,5mm cut out, D=16mm,  
flush mount, Splash proof



LED

**LED Courtesy Light**

**Item Code L4400287** Plastic housing LED  
1 x 5Ø, 50.000 hours, 12VDC/0,24W  
Color temperature: 2850-3200K, Warm White. Beam 30°x35°  
Dims.: Ø12,7mm, D=26mm, flush mount  
Splash proof



- Code L1901178** LED strip flexible with adhesive edge White
- Code L1901180** LED strip flexible with adhesive edge Red
- Code L1901181** LED strip flexible with adhesive edge Green
- Code L1901182** Set LED strips flexible wit adhesive edge 1x Red + 1x Green
- Code L1901179** LED strip flexible with adhesive edge Blue

**LED soft strips**

Voltage: 12V  
Material: Plastic  
Beam: 120°  
Colour temperature: 6300K  
LED Type: 18 x 3528 "SMD" LED  
Wattage: 1.44W  
Dimensions: Length: 300mm, With: 80mm  
Height: 2.2mm



LED

LED

**PIR DC- Switch (PDS- 10)**

The PDS--10 is a motion activated switch for automated on/off switching of BrightLine LED-armatures (on distance) and/or other users for 12 and 24V systems. This made use of a Passive Infra-Red sensor (PIR). On the output of the PDS-10 a load can be connected of max. to 10A (continuous) in 12 or 24V systems. The PDS-10 is for indoor use only. The PDS-10 has also some security features like disconnecting the load by overvoltage, under voltage and overcurrent.

Item Code 056001 PDS-10



**PLS-1 motion activated LED lamp**

The PLS-1 is a motion activated LED lamp for 12 and 24V systems for which a Passive Infra--Red sensor (PIR) is used. The PLS-1 has a built in high efficiency Power CREE LED (1 Watt). The PLS-1 is for indoor use only. The PLS-1 has also some security functions to prevent overvoltage, under voltage and overcurrent.

Item Code 056002 PLS-1



LED

Item Code	Auto Voltage	Standard Switch Time	Power Up Delay	Detection Angle	Detection Range	Weight	Dims. L x W x H
056001	12VDC /24VDC	5 min.	1 Sec.	60° H – 60° V	5m	30g	76,5x48,5x30mm
056002	12VDC /24VDC	5 min.	1 Sec.	60° H – 60° V	5m	35g	67x50x30mm

**Ideal LED lighting for example. Engine compartments!**

These newly developed series of LED lamps are ideal as engine compartment- cabinet- or console lights and have more than 100 lumens per watts! Lamps can also be switched by the PDS-10 (Item Code 056001) motion switch.

**Features:**

- Housing of anodized aluminum with optimal cooling of the LEDs
- Input voltage: 12V DC
- More than 100 lumen per watt
- Reverse polarity protection
- Cable can be bent back into plastic cover so that it does not protrude outside the housing.

		size	L x w x h
Item Code 056020	180 lumen	size	104 x 63 x 20
Item Code 056022	360 lumen	size	184 x 63 x 20
Item Code 056024	720 lumen	size	264 x 63 x 20
Item Code 056028	1440 lumen	size	344 x 63 x 20



LED lighting for example Engine compartments!

**LED**

### Hella Easy Courtesy Lights

Multivolt 12-24V, LED 0.5W, IP6K7K 30° beam.  
Stainless steel moon. Installation size Ø25 mm,  
installation depth 14 mm.

**Item Code 041422** LED white

**Item Code 041423** LED blue

**Item Code 041424** LED red

**LED**

### Hella Slim Line Courtesy Lights

Ø75mm, 12V, 0.5W, IP6K7K dimmable with  
**Item Code 041480.**  
Stainless steel ring. Installation size Ø50 mm,  
installation depth 13 mm.

**Item Code 041347** LED white

**Item Code 041348** LED blue

**Item Code 041343** LED red

**LED**

### Hella DuraLED 12

Multivolt 12-24V, LED 2.5W, beam 120°.  
Dim. 140x65x32mm (WxHxD).

**Item Code 041394** IP67, white

**Item Code 041395** IP67 with switch, white

**LED**

### Hella EuroLED 150 touch

Multivolt 9-33V, LED 4W, IP6K6 6K7  
Fully sealed, white plastic housing.  
Dim. 150x20mm (Øxh)

**Item Code 041520** white / red

**Item Code 041522** white / blue

Ø72mm, 12 or 24V LED <3W, 2700K,  
IP6K7 and IP6K9K completely sealed.  
Installation dimension Ø50 mm, installation depth 16 mm -  
screw mounting.

- Item Code 041383** 12V plastic ring, warm white
- Item Code 041384** 24V plastic ring, warm white
- Item Code 041386** 12V Stainless steel 316 ring, warm white
- Item Code 041387** 24V Stainless steel 316 ring, warm white

**Hella EuroLED 75**



**LED**

Multivolt 12-24V, LED <6W, 2700K,  
IP6K9K completely sealed stainless steel 316 ring.  
Installation dimension Ø72 mm, installation depth 27 mm,  
spring clip mounting.

- Item Code 041500** Ø95mm, warm white
- Item Code 041510** Square 78mm, warm white
- Item Code 041502** Ø95mm, warm white/ red
- Item Code 041512** Square 78mm, warm white/ red

**Hella EuroLED 95 GEN 2**



**LED**

Multivolt 9-31V, LED <2W IP53, 4000K white and red.

- Item Code 041487** Length 150mm
- Item Code 041488** Length 400mm

**Hella Flexi-spot Chart Light**

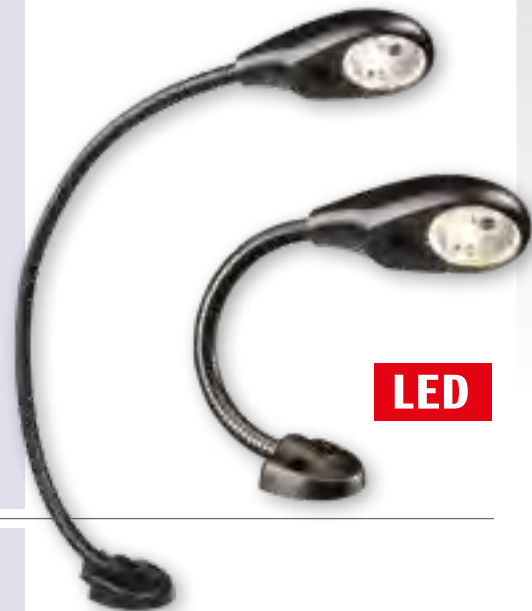

**LED**

8-30V, 2 x 10A protects against overload, high temperature  
and low battery voltage. Number of switches per group is  
unlimited. Dim. 99x89x41mm (W x H x D).

- Item Code 041480** Max power 12V-200W / 24V-400W

**Hella two groups of dimmer**



**NEW**

**Hella marine** 



The Apelo RGB Multi-color lighting can be operated from different RGB controllers but also works without an external RGB controller. In this mode, the effect is 3 lamps in one. You can choose all colors that are desired, but a separate switch is then needed for each color. you can color mix to get an extra color if desired.



### Apelo A1

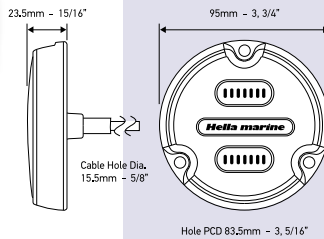

Anthracite colored plastic housing, Multivolt 9-32V, LED, IP68/IP69

**Item Code 041560** 20W, 1800 Lumen, white/blue  
Comes with 2.5 meter cable

**Item Code 041562** 15W, RGB Multi-color  
Comes with 2.5 meter cable



### Apelo A2 Aluminium housing

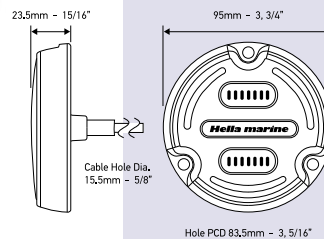

Anthracite-coloured hard anodized aluminum housing and bling ring (ambient lighting).  
Multivolt 9-32V, LED 30W, IP68/IP69

**Item Code 041565** 30W, RGB Multi-color, 3000 Lumen  
Comes with 2.5 meter cable



### Apelo A2 Bronze housing

White lens with bronze housing (marine grade) and bling ring (ambient lighting).  
Multivolt 9-32V, LED 30W, IP68/IP69

**Item Code 041567** 30W, RGB Multi-color, 3000 Lumen  
Comes with 2.5 meter cable



**Item Code 025160 12V / 3.5W**

Surface mount Stainless Steel 316 High Power LED Hull Light. Complete kit.

- IP66
- 6300K
- Illumination 300 Candela
- UV resistant
- Surface mount
- Dims. 105x62x34mm (L x W x H)

**Surface mount  
S.S. Hull Light**

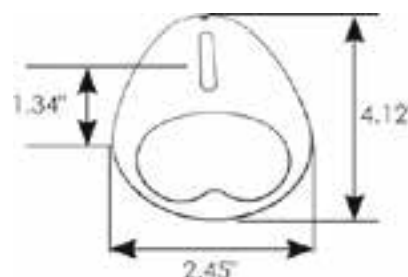

**Item Code 025165 12V / 5W**

Surface mount Stainless Steel 316 High Power LED Hull Light. Complete kit.

- IP66
- 6300K
- Illumination 300 Candela
- UV resistant
- Surface mount
- Dims. 190x114x35mm (L x W x H)

**Surface mount  
S.S. Hull Light**

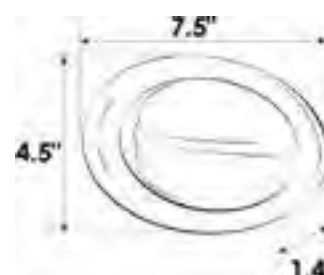



**Navigation  
Lights Bow  
Mount**

2-Color Navigation Lights. Bulb type: Festoon 12V/3W  
Splash proof

**Item Code L4400153**

Red/green, 2 x 112,5°, Stainless Steel A304  
Dims. Ø57mm, H=35mm (Ref A)

**Item Code L4400154**

Red/green, 2 x 112,5°, Chrome Plated Zinc with Plastic Base.  
Dims. Ø102mm, H=79mm (Ref B)



**Stainless  
Steel Navigation  
Lights Pair**

Stainless Steel A304 housing, 102x54x38mm (lxwxh), 12VDC  
Bulb type: Car lamp 5W/12V  
Side mount, 112,5°  
Splash proof

**Item Code L4400197** Pair of lights, 1 x red + 1 x green



**Stainless  
Steel Navigation  
Lights Pair**

Stainless Steel A304 housing, Ø57mm, H=35mm, 12VDC  
Bulb type: Bayonet BA15D 12V/3  
Splash proof

**Item Code L4400198** Pair of lights, 1 x red + 1 x green  
Horizontal mount, 135°

**Item Code L4400199** Pair of lights, 1 x red + 1 x green  
Side mount, 112,5°



**Stainless  
Steel Navigation  
Lights Pair**

Side-, flush mount, 112,5°  
Splash proof

**Item Code L4400195** Pair of lights, 1 x red + 1 x green  
Stainless Steel A304 housing, 197x57x70mm (lxwxh), 12VDC  
Bulb type: Bayonet BA15D 6W/12V

**Item Code L4400196** Pair of Lights, 1 x red + 1 x green **LED**  
Stainless Steel A304 housing, 197x57x70mm (lxwxh) 12VDC



**Stainless Steel  
Stern Lights**

Stainless Steel A304 housing, Flush mount, 135°, Splash proof

**Item Code L4400345**

Stern Light. Bulb type: BA15D 8W/12VDC.  
Luminance 20LM Dims. 131x84x34mm (lxwxh)

**Item Code L4400346**

Stern Light. **LED** 6 x 0,5W, 50.000 hours, 12VDC.  
Luminance 128LM Dims. 131x84x34mm (lxwxh)

**Item Code L4400344**

Stern Light. **LED** 6 x 0,5W, 50.000 hours, 12VDC.  
Luminance 128LM Dims. Ø75mm, H=10,8mm, D=39,8mm

Polished stainless steel 304 housing, IP66.  
 Red and green LED in clear lens.  
 12-24V, 1/2W LED  
 For boats up to 12M

<b>Item Code 015540</b>	Red	112.5°
<b>Item Code 015541</b>	Green	112.5°
<b>Item Code 015542</b>	Red/Green	2x 112.5°

### LED Navigation Lights



LED

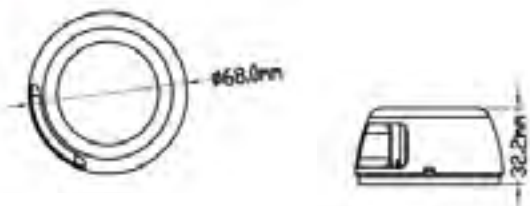

Polished stainless steel 304 housing, IP66.  
 Red and green LED in clear lens.  
 10-30V, 1.7/3.4W LED  
 For Boats up to 20m

<b>Item Code 015555</b>	Red	112.5°
<b>Item Code 015556</b>	Green	112.5°
<b>Item Code 015557</b>	Red/Green	2x 112.5°

### LED Navigation Lights



LED

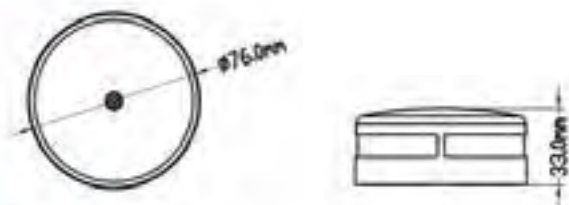

Chromed polycarbonate housing.  
 12-24V, 2.2W LED  
 For Boats up to 20m

<b>Item Code 015560</b>	White	360°
-------------------------	-------	------

### LED All-Round Navigation light



LED

LED



**LED Navigation Lights**

Black polycarbonate housing.  
RINA approval  
12-24V, 2.2W LED  
For Boats up to 20m

<b>Item Code 015510</b>	Red	112.5°
<b>Item Code 015511</b>	Green	112.5°
<b>Item Code 015512</b>	white motor light	225°
<b>Item Code 015513</b>	white stern light	135°



LED



**LED Navigation Lights**

White polycarbonate housing.  
RINA approval  
12-24V, 2.2W LED  
For Boats up to 20m



<b>Item Code 015520</b>	Red	112.5°
<b>Item Code 015521</b>	Green	112.5°
<b>Item Code 015522</b>	white motor light	225°
<b>Item Code 015523</b>	white stern light	135°

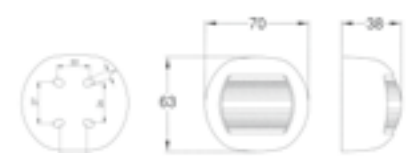

LED



**LED All-Round Navigation light**

Polycarbonate housing.  
RINA approval  
12-24V, 2.2W LED  
For Boats up to 20m

<b>Item Code 015530</b>	Black housing	White	360°
<b>Item Code 015535</b>	White housing	White	360°

Item Code L4401126 H=241mm

Item Code L4401127 H=635mm

LED 1 x 0,5W Cool White, 50.000 hours, 8-30VDC/0.5W  
Stainless Steel A304 tubing, ABS lamp and adjustable base

### LED All-Round Light



Item Code L4400226 H=635mm

Item Code L4400227 H=914mm

LED 1 x 0,5W Cool White, 50.000 hours, 8-30VDC/0.5W  
Stainless Steel A304 removable tubing, ABS lamp and base  
Universal angle 15°

### LED All-Round Stern Light

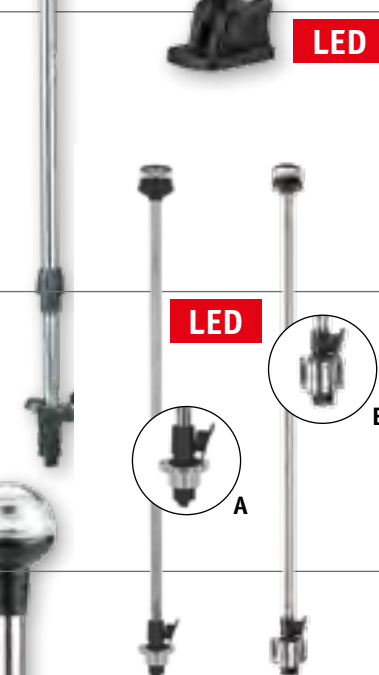

Item Code 015500 L=1000mm, 360°, Flat mounting A  
Removable All-Round stern light with Stainless Steel tubing and base, RINA aproval 12V, for Boots up to 20M

Item Code 015501 L=1000mm, 360°, Wall mounting B  
Removable All-Round stern light with Stainless Steel tubing and base, RINA aproval 12V, for Boots up to 20M

### LED All-Round Stern Light

Stainless Steel A304, ABS lamp and adjustable base.

Item Code L4400324 All-Round Light, BA15D, 12V/10W, H=241mm

Item Code L4400325 All-Round Light, BA15D, 12V/10W, H=635mm

Item Code L4400326 All-Round LED 12 x Ø5 Light, H=241mm

Item Code L4400327 All-Round LED 12 x Ø5 Light, H=635mm

### All-Round Light



Item Code 269035 L=610mm 360°

Removable All-Round stern light with Stainless Steel tubing and base.  
12V / 8W

### LED All-Round Stern Light

Stainless Steel A304 tube with Chrome Plated Brass Base  
ABS lamp.

Bulb type: Bayonet BA15D, 12V/8W

Universal angle 30°

Splash proof. Telescopic.

### All-Round Light

Item Code L4400101 All-Round Light, H=254mm

Item Code L4400102 All-Round Light, H=610mm

Item Code L4400103 All-Round Light, H=914mm



Item Code 078605

White top light with stainless steel pole  
Bulb 12V/10W. With cover.

A = 620mm, B = 545mm, C = Ø19mm, D = 23mm

### Retractable All Round Light 360°

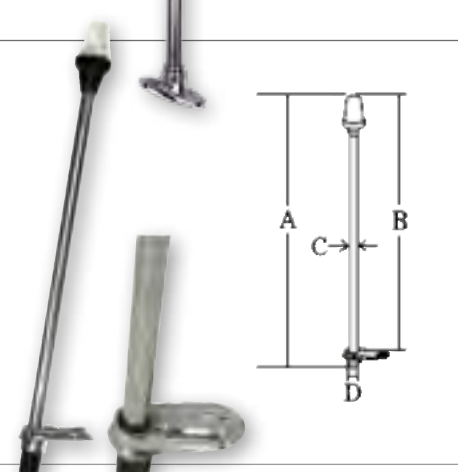



LED

**LED Navigation Lights**

LED 1 x 1W, 50.000 hours, 8-30VDC, Plastic housing, 107x93x61mm (wxhxd), Waterproof

Item Code		Housing:	Visibility:
L4400292	Red 112,5°	white	2nm
L4400291	Green 112,5°	white	2nm
L4400295	Red/green, 2 x 112,5°	white	2nm
L4400293	White 225°, Motor light	white	3nm
L4400294	White 135°, Stern light	white	2nm

LED



**LED Navigation Lights For Boats up to 12m**

LED 1 x 1W, 50.000 hours, 12VDC  
Plastic housing, 64x75x56mm (wxhxd), Waterproof

Item Code		Housing:	Visibility:
L4400125	Red, 112,5°	black	1nm
L4400115	Green, 112,5°	black	1nm
L4400155	Red/green, 2 x 112,5°	black	2nm
L4400135	White 225°, Motor light	black	2nm
L4400145	White 135°, Stern light	black	2nm
L4400126	Red 112,5°	white	1nm
L4400116	Green 112,5°	white	1nm
L4400156	Red/green, 2 x 112,5°	white	2nm
L4400136	White 225°, Motor light	white	2nm
L4400146	White 135°, Stern light	white	2nm



**LED Navigation Lights Luxe Stainless Steel 316 For Boats up to 12m**

Dims. 72 x 62mm (wxh). LED 12V-0,8W

Item Code		Housing:	Visibility:
L4400170	Red 112,5°	Stainless Steel	2nm
L4400171	Green 112,5°	Stainless Steel	2nm

LED



**LED Navigation Lights For Boats up to 12m**

Plastic housing 70x45x40mm (lxwxh)  
LED 012V-0,6W - 50.000 hours,  
Protection: IP66, 12V.

	Housing:	Visibility:	Item Code
Red 112,5°	black	1nm	L4400422
Green 112,5°	black	1nm	L4400421
Red/green, 2x 112,5°	black	2nm	L4400425
White 135°, Stern Light	black	2nm	L4400424

Plastic housing, Ø67mm, H=136mm.  
D-Cell batteries, 0,45W (not included)  
Floating and Waterproof

**Item Code L400000** Emergency 3pc-Set

### Navigation Lights Battery Operated



Dims. 89 x 115mm (Ø x h), 12V/10W (BAY15D)

Item Code	Housing:	Visibility:
L4400238 Tri-Color Nav. Light	Plastic	1nm
L4400237 Anchor Light white 360°	Plastic	1nm

### Tri-Color Navigation Light

Dims. 89 x 210mm (Ø x h)  
1 x 12V/10W (BAY15D) + 1 x 12V/25W (BAY15D)

Item Code	Housing:	Visibility:
L4400224 Tri-Color Light + Anchor Light white 360°	Plastic	1nm

### Anchor Light 360°

### Combination Light



ABS housing, Ø67mm, H=76mm, 12VDC  
Bulb type: Festoon 12V/10W  
Visibility: 2nm  
Waterproof

**Item Code L4400161** 360° Navigation light

### All-Round Navigation Lights for Boats up to 12m



Plastic Utility Light for chart reading, working- or courtesy light  
Bulb type: 1 x High-Efficiency 0,1A Bulb with 2nm visibility +  
1 x 0,24A Bright Bulb, 12VDC  
Two-Function Lens: Fresnel Lens for 2nm Visibility and Clear  
Bottom for Area Lighting  
Incl. automatic switch: ON at Dusk, OFF at Dawn

**Item Code L4401644** Utility Light with 12V plug & 15'  
(4,5m) cable

### Utility Light with automatic switch



Plastic housing, Ø54mm, H=71mm, 12VDC  
Bulb type: Bayonet BA15D 12V/8W  
Waterproof

**Item Code L4400106** Anchor light

### Anchor Light



Plastic housing, H=186mm, D=59mm, 12VDC  
Bulb type: Festoon 12V/10W + MR16 12V/10W  
Waterproof

**Item Code L4400100** Combo Masthead / Deck Light

### Combo Masthead/ Deck Light for Boats up to 12m





**NEW**

**Portable LED navigation light**

ABS housing, IP67, batteries 3x AA (not included).  
Octagonal locking base for surface mounted, recessed and dinghy mounting. Including cover.

**Item Code L0601103** red/green/combi

**Item Code L0601104** 360° white



**NEW**

**Portable LED navigation light Multi adapters**

ABS housing, IP67, batteries 3x AA (not included).  
For the most popular brands, 3 adapters supplied.

**Item Code L0601101** red/green/combi

**Item Code L0601102** 360° white



**NEW**

**Portable LED All-Round Top Light**

360° Top light with telescopic aluminum tube, IP67, batteries 3x AA (not included).

**Item Code L0601105** L = 790-1358mm.  
Includes octagonal locking base for side mounting



**NEW**

**Portable LED navigation light kit**

**Item Code L0601106**  
Navigation lights kit  
IP67, batteries 3x AA (not included).

Relief:  
- Red/green/combination  
- 360° white

Edit:  
- Surface mounted, recessed, side and dinghy mounting  
- 3 adapters for the most popular brands  
- Telescopic aluminum tube 790-1358mm



- For boats ≤20m (depending on area)
- BSH-Approval (and DHI, GL & VDE 0710)
- Antimagnetic
- Seawater resistant
- Forced ventilation
- Bayonet quick housing lock
- Hanging bulbs and contacts in upper part of the housing, prevent from electrolysis (series 041100-041108)
- IP-55 protection according DIN 40050
- Supplied with 12V long-life-bulb BAY15d

<b>Item Code 041100</b>	Mast top mount, black housing	25W	225°
<b>Item Code 041200</b>	Mast top mount, white housing	25W	225°
<b>Item Code 041102</b>	Stern mount, black housing	10W	135°
<b>Item Code 041202</b>	Stern mount, white housing	10W	135°
<b>Item Code 041104</b>	Starboard mount, black housing	25W	112,5°
<b>Item Code 041204</b>	Starboard mount, white housing	25W	112,5°
<b>Item Code 041106</b>	Port mount, black housing	25W	112,5°
<b>Item Code 041206</b>	Port mount, white housing	25W	112,5°
<b>Item Code 041108</b>	Pulpit mount, black housing	25W	2x112,5°
<b>Item Code 041208</b>	Pulpit mount, white housing	25W	2x112,5°

**Mastmount:** (bayonet lock for quick bulb replacement)

<b>Item Code 041150</b>	3-Color light, black housing	25W	2 x 112,5° + 135°
<b>Item Code 041160</b>	3-Color light with anchor light	25W + 10W	2 x 112,5° + 135° + 360°

**Signal lights:**

<b>Item Code 041165</b>	signal light white, black housing (anchor)	10W	360°
<b>Item Code 041265</b>	signal light white, white housing (anchor)	10W	360°
<b>Item Code 041166</b>	signal light red, black housing (anchor)	25W	360°
<b>Item Code 041167</b>	signal light green, black housing (anchor)	25W	360°

**Accessories:**

<b>Item Code 041120</b>	S/S Mounting Bracket, universal
<b>Item Code 041121</b>	S/S Mounting Bracket, for mast
<b>Item Code 041123</b>	Plastic Base, deck mount, black

**Spare Bulbs (BAY15d):**

<b>Item Code 041130</b>	25W/12V
<b>Item Code 041131</b>	10W/12V
<b>Item Code 041135</b>	25W/24V
<b>Item Code 041136</b>	10W/24V

**Hella NAVILED-Trio® Position lantern with BSH approval for sailing yachts up to 20 m under sail**

**Characteristics:**

- Ultra low power consumption - Port, starboard & stern lantern: Combined consumption lower than 3.5W (<0.29A @ 12V), anchor light consumes less than 1.5W (<0.13A @ 12V)
- Ultra-long service life - No maintenance: Install and forget
- IP 67 - Complete hermetically sealed unit
- UV resistant, shock and vibration resistant material
- Multivolt™ 8-28V - protected against voltage peaks up to + 500V, protected against pole change up to -700V / pre-wired with 400mm cable
- Stainless steel 316 Fixing pipe
- Weight 400g (incl. Cable)
- Minimum visibility: 2 nautical miles (sailboat)
- 7-year factory warranty!

<b>Item Code 041440</b>	NAVILED-TRIO 2NM (A) Sizes: Ø85 mm, H = 95mm
<b>Item Code 041442</b>	Adapter for mounting Windex (B)
<b>Item Code 041950</b>	NAVILED-TRIO + Adapter + Windex (C)



**NAVILED  
3-color /  
Anchor light**

041100 041102



A = 107mm, B = 108mm, C = 90

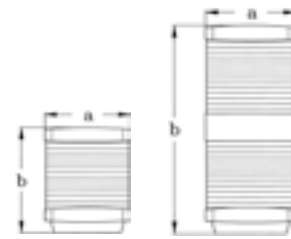

A = 88mm A = 88mm  
B = 107mm B = 200mm



041150 + 041160

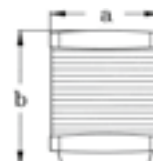

A = 88mm  
B = 107mm

041166





**Hella NAVILED**

Multivolt 9-33V - 360° navigation light. IP67, L = 1080 mm.

**Item Code 041367** Around 360° - 2 NM - black



**Hella NAVILED®360 navigation light**

Multivolt 9-33V - 360° navigation light. Base and mast made of anodized aluminum (H = 204 mm) and base W = 75 mm, hole spacing 57 mm, M6.

**Item Code 041335** Top light 360 ° - 2 NM - black base, Ø90 mm, H 83 mm

**Item Code 041351** Top light 360 ° - 2 NM - white base, Ø90mm, H 83mm

**Item Code 041359** Top light (folding) on aluminum rod, 360° - 2 NM - black base, Ø90 mm, H 83 mm



**Hella NAVILED - 360° navigation light**

Multivolt 9-33V - 360° navigation light, IP67, dim. height = 60 mm.

**Item Code 041362** Around 360° - 2 NM, black

**Item Code 041364** Around 360° - 2 NM, white

**Item Code 041361** Around 360° - 2 NM on foot, black



**Hella NAVILED® navigation light**

Multivolt 9-33V, Dims. 90x38.5x50mm (wxhxd).

**Item Code 041377**

Set Port 112.5° and starboard 112.5°, 2NM, black

**Item Code 041378**

Set Port 112.5° and starboard 112.5°, 2NM, white



**Hella NAVILED® navigation light**

Multivolt 9-33V, Dims. 71x53x33mm (wxhxd).

**Item Code 041352** Port 112,5° - 2 NM - black

**Item Code 041353** Port 112,5° - 2 NM - white

**Item Code 041354** Starboard 112,5° - 2 NM - black

**Item Code 041355** Starboard 112,5° - 2 NM - white

**Item Code 041356** Stern 135° - 2 NM - black

**Item Code 041357** Stern 135° - 2 NM - white



**Hella NAVILED PRO**

Multivolt 9-33V, Dims. 87x90x57mm (wxhxø).

**For Boats up to 20m**



**Item Code 041300** Port 112,5° - 2 NM - black

**Item Code 041320** Port 112,5° - 2 NM - white

**Item Code 041302** Starboard 112,5° - 2 NM - black

**Item Code 041322** Starboard 112,5° - 2 NM - white

**Item Code 041304** Stern 135° - 2 NM - black

**Item Code 041324** Stern 135° - 2 NM - white

**Item Code 041310** Masthead 225° - 3 NM - black

**Item Code 041329** Masthead 225° - 3 NM - white

**Item Code 041332** Bi-Color 225° - 3 NM - black



Multivolt 12-24V LED 3W 200 lumen.  
Dim. 136x53x49mm (WxHxD).

**Item Code 041412** IP6K7K width beam, black housing

### Hella Sea Hawk



Multivolt 9-33V LED white <12W, LED blue <4W 750 lumen.  
Dim. 170x68x58mm (WxHxD).

**Item Code 041411** IP6K7K width beam, black housing

### Hella Sea Hawk-XL



Multivolt 9-33V LED 21W 2100 lumen.  
Dim. 83x110x74mm (WxHxD). IP6K9K completely sealed.

**Item Code 041450** Spot, black house

**Item Code 041451** Width radius, black housing

### Hella model 70 Generation 4



Multi-volt 9-32V, 6500K, IP6K6K, IP6K8.  
dim. 243x38x66mm (lxwxh).

**Item Code 041540** BASE 14W LED, 1200 Lumen, Black

**Item Code 041542** PRIME 28W LED, 2500 Lumen, Black

### Hella FMS LED deck lighting

**NEW**



Multivolt 12/24V, LED max. 36W, 2200 Lumen, 5000K.  
dim. 524x67x57mm (lxwxh).

**Item Code 041557**

Black house, Combi (Spot and wide beam light)

**Item Code 041457**

White house, Combi (Spot and wide beam light)

**Item Code 041459**

Mounting bracket for two Sea Hawk-470 lamps

**NEW**

### Hella Sea Hawk-470 Light bar



**NEW**



### Hand Held Search Light

**Item Code 078350**

- Halogen light 12V / 55W
- Waterproof
- Soft rubber housing
- Spiral cable L = 2 m with cigarette lighter plug
- Including switch
- Weight ± 0,4kg



### Hella Twin Beam Hand Held Search Light

**Item Code 041400** Search Light

**Item Code 041405** Deck Mount base

Two reflectors and two halogen bulbs on separate switches. On/Off-switch for 12V/55W H3 bulb for 550 m range. Trigger switch integrated into the grip for 12V/100W H3 bulb for 600 m range. Range both bulbs together 750 m. Ø154mm, L = 166mm. 3.5 m Spiral cable with cigarette lighter plug. Degree of protection IP X6K. Shock and vibration resistant plastic housing.



### LED Hella Twin Beam Hand Held Search Light

**Item Code 041418** LED Search Light

**Item Code 041405** Deck Mount base

12-24V, 30W LED, 2500LM. IP6K9, IP6K8  
On/Off and Trigger switch for Morse Code function. Spiral cable with cigarette lighter plug.



### LED Spot Light

**LED** 8 x 3W "Osram", 50.000 hours, 10-30VDC/24W  
Dims. Ø116mm, H=135mm, D=43mm  
Color temperature: 6000-6500K, Cool White. Beam 15°  
Luminance 1400LM, Protection: IP67

**Item Code L2001511** **LED** Spot Light, Aluminum Housing, Acrylic Lens, Stainless Steel A304 Bracket

Search Light 125000K, reach 262m

**Item Code 180010** Manual control 12V/5A (Halogen)

**Item Code 180011** Manual control 24V/3A (Halogen)

**Halogen**



Search Light 170000K, reach 320m

**Item Code 180013** 12V/4A (LED) - electrical control

**Item Code 180023** 24V/2A (LED) - electrical control

**Item Code 180015** wireless 12V/4A (LED)

**Item Code 180025** wireless 24V/2A (LED)

**Search Light IP65**

**LED**



**LED**

**Double Search Lights**

New powerful searchlight with improved style and performances, ideal for small, medium and big- sized yachts. Double Sealed beam halogen light 5". Complete with waterproof control panel

**Item Code 180213** DoubleSearchLight12V/13A,electricmotor3A

**Item Code 181113** Spare unit with double beam 12V

**Item Code 180090** Spare Wiring Loom 4m

**Item Code 180132** Panel 12V.

**Halogen Double Search Light**

**IP65**



Powerful Search Light with Single Sealed Beam Xenon 55W Bulb 2000 hours lifetime. Bright light: color temperature 8000K Candle Power 550.000. Range at 1 Lux: 800m Gives a 3 times wider beam pattern and delivers 3 time more light than a standard halogen light. Dims. 350x260x320mm (lxwxh) Complete with waterproof control panel Adjustment: 360° horizontal, 70° vertical

**Item Code 181232** Xenon Search Light 12V, complete unit

**Item Code 181242** Xenon Search Light 24V, complete unit

**Item Code 181132** Xenon Spare Sealed Beam, 12V

**Item Code 181142** Xenon Spare Sealed Beam, 24V

**Item Code 180090** Spare Wiring Loom 4m

**Item Code 180132** Panel 12V.

**Item Code 180142** Panel 24V.

**XENON Search Light**

**IP65**

± 1000 Hours, also continuously.

**XENON**



**Item Code L1901650** 545LM LED Search Light with

Remote control

Voltage: 10-30V

Material: Housing made from PC, base made from Nylon, 4m Kable

Beam: 110°

Adjustment: 355° & E70°

Range remote control: 50 m

Colour temperature: 5500-6300K

LED Type: 9 x 3W Cool white

Protection: **IP67**

Dimensions: Diameter Base: Ø120mm

Height: 262mm

Length: 213mm

Lens: Ø165mm

**LED Search Light with Remote control**



## allpa SPORT AGM

See Battery Box - P 121



### allpa SPORT AGM

This Dual Purpose AGM batteries are designed for use in the recreational applications: high starting power, adequate cyclic capacity and fast reloading. Thanks to web technology, they offer the ultimate in ease use and absolute safety. These batteries are maintenance free, can be tilted and installed in any normal ventilated space.

Item Code		Voltage	Capacity	Weight	Dimensions (LxWxHxTH)
094003	ALLPGM60	12	60Ah	16,9 kg	242 x 175 x 190 x 190
094006	ALLPGM70	12	70Ah	19,5 kg	277 x 174 x 190 x 190
094008	ALLPGM95	12	95Ah	26 kg	354 x 175 x 190 x 190
094010	ALLPGM100	12	100Ah	27,4 kg	330 x 172 x 218 x 242

## allpa DEEP CYCLE AGM

### allpa DEEP CYCLE AGM

By far the best AGM battery for cyclic use. In AGM batteries, the electrolyte is retained in microporous glass fiber separators. These batteries do not leak, can be fitted in a tilted position and in normal use they can be easily installed in any normal ventilated space.



Item Code		Voltage	Capacity	Weight	Dimensions (LxWxHxTH)
094020	ALLPDC125-12	12	125Ah	33 kg	325 x 172 x 222 x 222
094023	ALLPDC160-12	12	160Ah	44,5 kg	483 x 170 x 240 x 240
094025	ALLPDC190-12	12	190Ah	55 kg	530 x 209 x 214 x 219
094027	ALLPDC210-12	12	210Ah	60,5 kg	522 x 240 x 219 x 240
094029	ALLPDC280-12	12	280Ah	74 kg	520 x 268 x 220 x 225

## allpa SPORT

See Battery Box - P 121

Recreational vessels need powerful and reliable batteries. The series allpa SPORT is perfect for the job! The extra thick X-Frame® grid with calcium-high tin technology, glasmats separators and unique carbon additives in the active mass provide fast load absorption, low self-discharge and long life.

- Sealed and maintenance free
- Long lifespan
- Inspection eye with charge indicator

## allpa SPORT



Item Code		Voltage	Capacity	Weight	Dimensions (LxBxHxTH)	
094100	ALLP60M	12	60Ah	12,7 kg	242 x 175 x 175 x 175	
094103	ALLP70M	12	70Ah	15,7 kg	277 x 175 x 175 x 175	
094105	ALLP95M	12	95Ah	21,2 kg	354 x 175 x 190 x 190	
094107	ALLP102M	12	105Ah	24,4 kg	330 x 172 x 220 x 240	single pole
094108	ALLP31M	12	105Ah	25 kg	330 x 172 x 218 x 239	double pole
094110	ALLP120M	12	120Ah	34 kg	506 x 182 x 210 x 233	
094113	ALLP165M	12	165Ah	39,8 kg	506 x 212 x 210 x 230	
094115	ALLP200M	12	200Ah	51,5 kg	509 x 274 x 218 x 238	
094117	ALLP225M	12	225Ah	56,6 kg	509 x 274 x 218 x 238	

Item Code 078480 Battery clamp set 60 x 37mm (L x B)

Item Code 078481 Set of battery terminals with plastic cover  
A = 65mm, B = 45mm, C = 24mm

## Battery Terminal Sets



## Battery cable eyelets

Eyelets stamped out of tube. Double thick thus very strong. Will not break and have very good conductivity. Price per piece, **minimum quantity 10 pieces.**

Code	Description	Code	Description
056300	25mm <sup>2</sup> /M 6	056310	50mm <sup>2</sup> /M 8
056302	25mm <sup>2</sup> /M 8	056312	50mm <sup>2</sup> /M10
056304	25mm <sup>2</sup> /M10	056314	50mm <sup>2</sup> /M12
056306	35mm <sup>2</sup> /M 8	056316	70mm <sup>2</sup> /M10
056308	35mm <sup>2</sup> /M10	056318	70mm <sup>2</sup> /M12

## Battery cable eyelets



**Battery cables** Extreme flexible, neoprene cable jacket. Available in 25, 35, 50 & 70mm<sup>2</sup>, Price per meter, minimum qty 10m p.item.

Item Code	Description
056325/R	Battery cable 25mm <sup>2</sup> , red
056328/R	Battery cable 35mm <sup>2</sup> , red
056330/R	Battery cable 50mm <sup>2</sup> , red
056332/R	Battery cable 70mm <sup>2</sup> , red

Item Code	Description
056325/Z	Battery cable 25mm <sup>2</sup> , black
056328/Z	Battery cable 35mm <sup>2</sup> , black
056330/Z	Battery cable 50mm <sup>2</sup> , black
056332/Z	Battery cable 70mm <sup>2</sup> , black

## Battery cables





## Energy meter

### Technical data of the instrument:

<b>Power supply</b>	from 10 to 30V DC
<b>Current intake</b>	Min. 5mA-max. 40mA
<b>Protection rating cover</b>	IP65
<b>Operative temperature</b>	0 / +70°C
<b>Display resolution</b>	128 x 64 pixel
<b>DC Voltage measure</b>	0.0...30.0V (± 0.5%)
<b>DC Current measure</b>	0.0...300A (± 0.5%)
<b>DC Power measure</b>	0...9000W (± 0.5%)
<b>Size</b>	100 x 100 x 32mm (without protect. cover)
<b>Weight</b>	160g

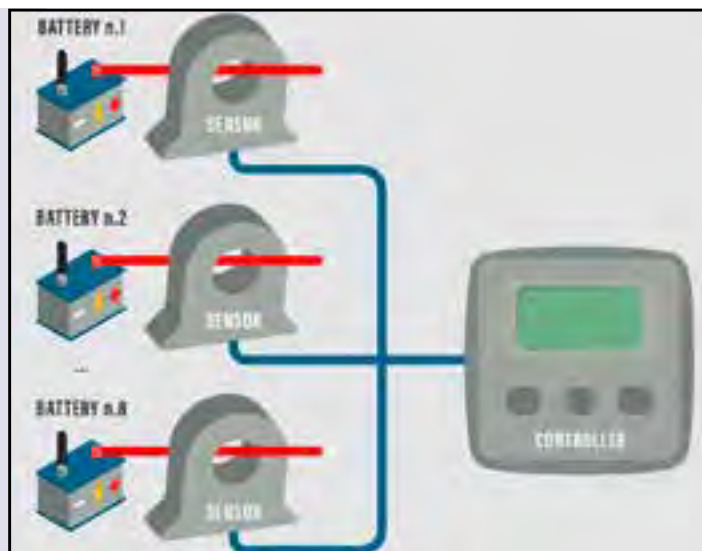

The EVVA-M voltmeter-ammeter allows you to measure the current and voltage of a maximum of 8 batteries simultaneously and to report voltage and current alarm conditions which differ from maximum and minimum values set.

### Technical data of the sensor:

<b>Power supply</b>	from 10 to 30V DC
<b>Current intake</b>	<1.3W
<b>IP-Protection rating</b>	IP20
<b>Operative temperature</b>	-15 / +65°C
<b>Size</b>	89.1 x 99.25 x 28.5mm
<b>Weight</b>	370g
<b>Type of measure</b>	DC continuous
<b>Sampling rate</b>	11K samples/sec
<b>Overvoltage category</b>	Cat IV (100V)

### The package contains:

- Voltmeter-Ampere meter, seal and closure cover
- One sensor for voltage, current and power measure
- 10-pole male connector with crimp-type 10 male contacts
- instructions for use

**Item Code 149020** Energy meter-set: display + 1 x sensor

**Item Code 149025** Extra sensor for energy meter  
(one required for each battery)



## Battery WATCH

**Item Code 056185** Universal Battery Alarm with buzzer and alarm contact Ø45mm, H=20mm

The UBA has 3 main programs with buzzer and alarm contact. The first two programs to "remember" the consumer to recharge the battery from the electric vehicle. The third program is meant as an universal under voltage alarm for 12V or 24V systems.

### START-/STOP system for generator or charger:

Through the alarm output from the UBA, it is possible to connect for example a generator or battery charger. In case of under voltage, it will start and if the battery is full, stopped.



**High precision battery monitors**

The **E-xpert lite** features the basic display indications for two batteries. The **E-xpert Pro** displays also the remaining battery capacity and time remaining and shows not only the actual but also history events. A RS-232 or USB interface for laptop read out is optional. Both monitors have an alarm relay. The e-xpert pro is equipped with an internal programmable alarm relay, to run a generator.

**Features:**

- Display indications :
- Charge- and discharge current
- Remaining battery capacity
- Programmable alarm relays
- Splash proof front panel
- CE & e-mark certified
- Voltage
- Two battery inputs
- Large backlit LC Display
- 24 months warranty!
- Consumed amp/hours

**Extra features e-xpert Pro:**

- Temperature sensor (option)
- Displays battery time remaining
- Stores a wide range of history events in internal memory
- Fully programmable alarm relay
- Isolated RS-232 interface (option)
- Isolated USB interface (option)
- Windows XP/ Vista/7 Software for laptop (option)

<b>Item Code 056190</b>	<b>e-xpert lite</b>	Battery Monitor 0-35 VDC
<b>Item Code 056192</b>	<b>e-xpert pro</b>	Battery Monitor 0-35 VDC
<b>Item Code 056189</b>	<b>e-xpert pro-HV</b>	Battery Monitor 14-70 VDC

<b>Item Code 056193</b>	Quick Connection kit 3m for e-xpert lite & pro
<b>Item Code 056194</b>	Quick Connection kit 10m for e-xpert lite & pro
<b>Item Code 056197</b>	Battery temperature sensor kit 10m for e-xpert pro only
<b>Item Code 056198</b>	Battery temperature sensor kit 20m for e-xpert pro only
<b>Item Code 056199</b>	USB communication kit incl. dashboard software Windows XP/Vista/7 for e-xpert pro only
<b>Item Code 056200</b>	RS-232 communication kit incl. dashboard software Windows XP/Vista/7 for e-xpert pro only

**Battery WATCH  
e-xpert lite  
e-xpert pro**



**Item Code 056180 BW-02 Battery Watch Monitor**

Smart piece of equipment which monitors the status of the battery and displays it in an intelligent way. Water resistant top, Ø 35mm (M32/T=20mm), weight 40 gr. If the battery is connected to a voltage between 7 and 32V, it will detect the battery voltage before displaying the status of the battery by the 3-color LED display.

**Battery WATCH**



**Item Code 056182 BW-03 Battery Watch Monitor - Red**

The BW03 is a smart battery meter that can measure and display the voltage of one or more batteries. It can also generate an alarm from under--and over-- voltage difference.

**Features**

- programmable
- Water--resistant front site, Ø60mm
- several battery monitoring
- Power-save function
- Switched alarm output
- Auto Voltage Detection

**Connecting**

A total of 5 different battery configurations are possible on the BW03: 1x 12V - 1x 24V - 2x 12V - 2x 24V - 1x 12V & 1x 24V

**Battery WATCH**





## PLUG AND PLAY BATTERY CHARGERS

# Dolphin premium



Dolphin premium	12V				
	10A	15A	25A	40A	60A
<b>Input (AC)</b>					
Input Voltage	230V (+/-15%) 115V available on request		115V/230v (+/-15%) Automatic Switch over		
Frequency	50HZ/60Hz (+/-10%)				
Cos phi	0,6 type		0,9 type		
Efficiency	80% type				
Max. Current 115V/230V	NA/1,3A	NA/1,9A	4A/2A	7A/3,5A	12A/6A
Fuse (5x20mm)	T2A 250V	T3,15A 250V	T6A 250V	T10A 250V	T16A 250V
<b>Output (DC)</b>					
Number of outputs	3 isolated outputs				
Number of charging curves	4 programs, position selected by dip switch, NEW: one of which is LiFeSO4 with integrated BMS				
Charging curve	IUUo + weekly automatic equalization				
Weekly equalisation	Automatic				
Voltage share	+/-2%				
Ripple	<1% pp (BW<20Mhz)				
Fuse (automotive mini)	F15A 32V	F20A 32V	2xF15A 32V	2xF25A 32V	3xF25A 32V
<b>Protection</b>					
In case of output overload, Excessive internal temperature, Charging voltage too high, Reverse battery polarity (fuse)					
<b>General</b>					
Display	Tricolor LED				
Night/Silent mode	By button				
Operating temperature	-10°C to +50°C				
Storage temperature	-20°C to +70°C				
Humidity	10% to 90% (without condensation)				
Ventilation	Natural		Forced fan cooling		
Security	EN60335-2-29 (2002)				
Housing	Powder coating aluminum				
Mounting	2 screws 4mm				4 screws 4mm
Dimensions	96x120x238		96x120x354	284x240x115	
Weight	1,30kg		1,90kg	3,1kg	
Input terminals	20A-230V, 4mm <sup>2</sup> max WINSTA-WAGO 770.813/G11-000				4 Poles 35mm <sup>2</sup> 125A max, clamp terminals
Battery terminals	40A-630V, 10mm <sup>2</sup> max PHOENIX CONTACT PC6-16/4-G1F,16				
CANbus	No				Yes
<b>Item Code</b>	<b>086212</b>	<b>086213</b>	<b>086214</b>	<b>086215</b>	<b>086216</b>

# Dolphin premium

- New robust and compact casing
- 3 Completely isolated battery outputs
- Easy wiring and connection thanks to the Winsta (Wago) and Phoenix contact connectors
- Digital management with up to date microcontroller
- 4 Charging programs including one for lithium-ion—iron-phosphate with integrated BMS
- Full power at temperatures up to 50°C
- Automatic weekly equalization for all charging programs
- Automatic 115V/230V switchover (12V-25A & 40A only)
- Night mode: silent – without fan (12V-25A & 40A only)
- Conformal coating of PCB to prolong battery charger life
- 4 Years warranty
- Worldwide service

## PLUG AND PLAY BATTERY CHARGERS



## DOLPHIN PROLITE PLUG & PLAY BATTERY CHARGERS • WATER-RESISTANT IP65

- Super-compact
- Fan-less (thus silent)
- Dust- and water-resistant (IP65)
- Ignition-protected (ISO 8846)
- Suitable for Lead, gel AGM, Calcium & Lithium-ion batteries
- 4 Charger modes
- Bluetooth Interface
- Free App (Android, iOS)
- 230V/50Hz input

### ProLite Series



Item Code 086280  
12V, 15A, 2 x out, dims. 142 x 195 x 72,5mm

Item Code 086281  
12V, 25A, 3 x out, dims. 142 x 244 x 72,5mm



## ALL-IN-ONE AC DISTRIBUTION SYSTEM & BATTERY CHARGER

# Dolphin

all-in-one

- Includes AC protection, two 10 amps AC circuit breakers and a smart 12V DOLPHIN PREMIUM battery charger
- Cost effective All in One concept
- Ensures AC safety: RCD (Residual Current Circuit Breaker),
- Double Pole Main Breaker and 2 x single pole breakers
- The internal charger is similar to the 25A DOLPHIN PREMIUM unit
- DC and AC connectors have been carefully designed to meet the highest quality and safety standard
- Conformal coating of PCB to prolong the life of the battery charger

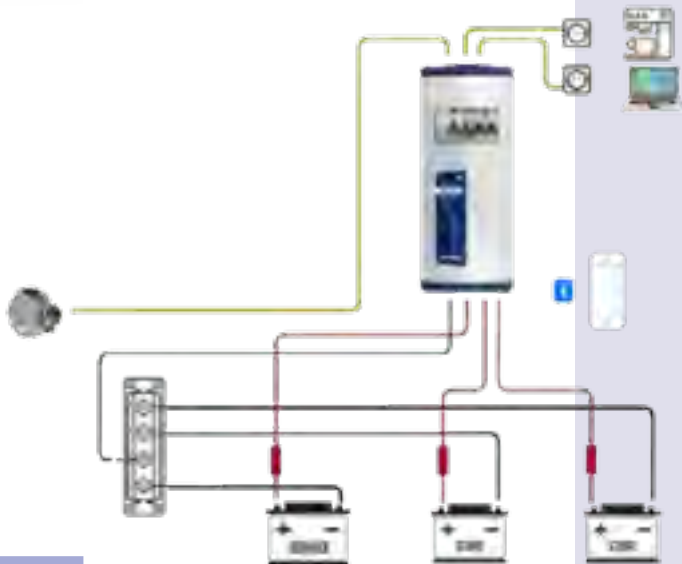

Dolphin All-in-One		12V-25A
<b>Main power characteristics</b>		
Voltage	230V (+/-15%)	
Frequency	50HZ/60Hz (+/-10%)	
Charger consumption	2,5A	
Auxiliaries consumption	Max. 10A total for both outputs	
Infopaneel	LED (yellow)	
Differential circuit breaker	16A 30mA	
Charger fuse	T6,3AT10A	
Infopaneel	On/Off LED (yellow)	
<b>Battery charger characteristics</b>		
Voltage	115V-230V +/- 15%	
Frequency	50 - 60Hz +/- 10%	
Number of outputs	3 Isolated outputs	
Charging programs	Total 8	
Charge selector	Toggle switch inside case	
Voltage tolerance	+/- 2%	
Ripple	<1%	
Max. current	25A +/- 5%	
DC fuse	F30A	
Protection	By fuse in the event of internal overheating, abnormal output voltage, output short-circuit or reverse polarity	
Display	3-Color LED on front panel Yellow: Boost mode /Green: Float mode /Red: Fault	
<b>AC auxiliary output characteristics</b>		
Number of outputs	2	
Voltage	Same as mains power voltage	
Frequency	Same as mains power frequency	
Max. current	10A	
Protection	10A magnetic thermal circuit breaker	
<b>General specifications</b>		
Operating temperature range	-10°C to +55°C	
Storage temperature range	-20°C to +70°C	
Dimensions (wxhxd) mm	395x188x103	
Weight	3kg	
<b>Item Code</b>	<b>086259</b>	

# Dolphin ACS

- Smart Voltage Sensing Relay
- Current Limit Function
- One way operating "blocking diode function"
- No solid state relay
- Mosfet technology with microprocessor control
- Perfect for outboard engine
- Pulsed charge feature
- Very low leakage current (< 5mA)
- Manual override
- Multi-color LED control

## ACS 12/50 - ACS 12/80

### Specifications

System Voltage	12V
Current	50A Continuous 120A Peak
	80A Continuous 190A Peak
<b>Voltage Operation</b>	<b>LED Operation</b>
<i>Engages:</i>	Off: Disengaged
BAT_IN > 13,0V 90s	Green flashing: Engagement soon (max 90s)
BAT_IN > 13,6V 30s	Green: Engaged
BAT_OUT < 10,5V	Yellow Flashing: Pulse charge mode
<i>Disengages:</i>	Red: Overvoltage or temperature fault
BAT_IN < 12,4V 10s	Red flashing: Under voltage fault
BAT_IN < 12,7V 30s	
	<b>Protections:</b>
	Over temperature
	Over load
	Under & Over "start" Battery voltage
<b>ISO 13297, ISO 10133, ISO 8846. Waterproof: IP67</b>	
<b>Item Code 086275</b>	12V/50A Continuous (120A Peak)
<b>Item Code 086276</b>	12V/80A Continuous (190A Peak)

## DOLPHIN AUTOMATIC CHARGE SELECTOR 12V-50A

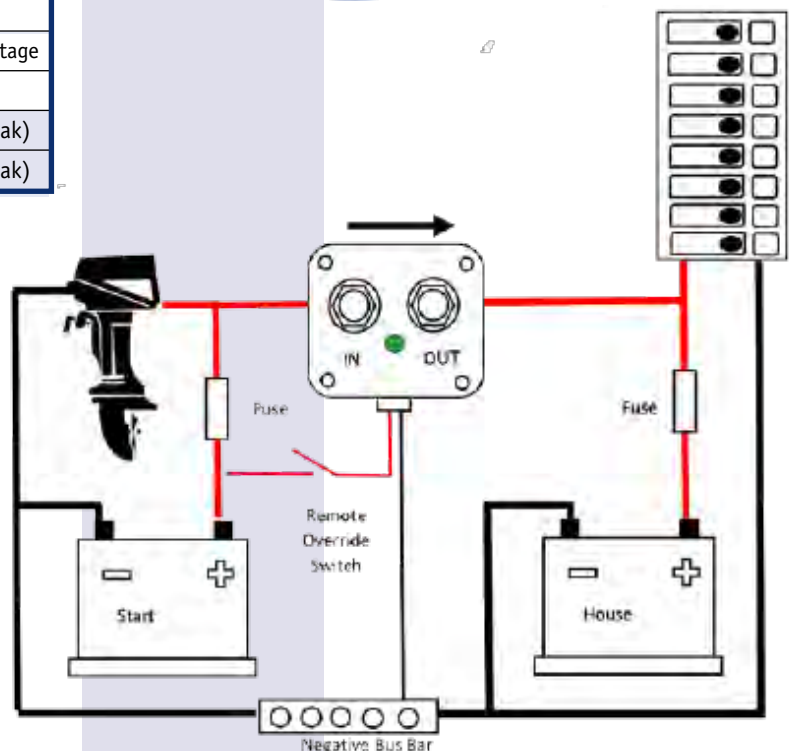



**ROBUST AND  
POWERFUL  
MARINE  
BATTERY  
CHARGERS**

# Dolphin pro



Dolphin pro	24V		
	40A	60A	80A
<b>Input</b>			
Input Voltage	115/230V (+/-15%)		230v (+/-15%)
Frequency	50HZ/60Hz		
Cos phi	>0,9		
Efficiency	87%		
Max. Current 115V/230V	14A/6A	15A/9A	15A
Fuse (6,35x32mm)	T20A	T20A	T20A
<b>Output</b>			
Number of outputs	3		
Number of charging curves	Open lead acid / Sealed lead acid / Lead calcium / Calcium -calcium / Spiral cell AGM / Winterizing open lead acid / Winterizing sealed lead acid / GEL AGM / Power supply / LifeSo4 + BMS		
Charging curve	IUUo		
Voltage share	+/-2%		
Ripple	<1% (BW<20Mhz)		
Fuse (automotive mini)	3F25A	3F25A	5F25A
<b>Protection</b>			
Output current limited / Output short circuit / Overload output voltage / Reversed polarity / Over temperature			
<b>General</b>			
Display	LED display or optional touch multi-color Touch-View		
Operating temperature	-10°C to +65°C		
Storage temperature	-20°C to +70°C		
Humidity	10% to 95% (without condensation)		
IP	IP22		
Ventilation	Forced fan adjustable speed cooling		
Safety	EN 60335-1		
EMC	EN 55016, IEC 61000		
Housing	White Powder coating aluminum		
Mounting	Wall mounted 4 x M4 Screws		
Dimensions DxWxH (mm)	128 x 346 x 358mm		
Weight	6kg		
AC Connection	3-Point cage terminal 10mm <sup>2</sup> max		
DC Terminal	4 M8 terminals		
Output alarm contact	1A 30V NO		
Battery temp. sensor	2-Point 1,5mm <sup>2</sup> cage terminal		
<b>Optional connections</b>			
External touch screen Control panel	RJ45 Touch-View		
CANBus	2 Micro-Fit & RJ11		
<b>Item Code</b>	<b>086227</b>	<b>086228</b>	<b>086229</b>

# Dolphin pro

## ROBUST AND POWERFUL MARINE BATTERY CHARGERS



- 9 Charging programs (including 2 winterizing and 1 power supply) depending on battery type, makes this charger suitable for all charging needs
- Can operate up to 65°C without derating
- Internal diode isolator without voltage drop
- Solid casing in aluminum, mounting by 4 easily accessible screws
- Front cover allowing easy access to the charge selector and the wiring connections (4 solid M8 terminals for the battery outputs)
- **Integrated Control Panel:** LED display indicating the charging curve (boost, absorption, floating), as well as anomalies and faults (temperature, voltage, fuses...)
- Equipped with 3 isolated outputs, automatic switchover 115V / 230V, 50Hz / 60Hz
- Conformal coating of PCB to prolong the life of the battery charger
- Standard with battery temperature sensor
- **Using Built-in CANBus J1939 interface, the Dolphin Pro can be connected to any monitoring system**
- Optional extras : external touch screen control panel Touch-View



• Item Code 086227 24V-40A

• Item Code 086228 24V-60A

• Item Code 086229 24V-80A

### TOUCH VIEW CONTROL PANEL

- Optional external touch screen control panel for Dolphin Pro range
- Tactile, with CANBus connection
- You can supervise your charger and your battery bank
- 5 languages menu : temperature, error messages, charging current, charging curve selected, charging phase (boost, absorption, float), power max delivered
- Bore Ø72mm – 16-bit interface for i80system – Illumination: White LED. Conformity: ROHS

Item Code 086238



086227



086228



086229



086238

**INVERTER / CHARGER  
2000W / 80A**

**Freedom XC  
Inverter/Charger**



**Freedom XC  
INVERTER/  
CHARGER**

The Freedom XC inverter / charger offers premium performance for a lightweight and compact device. Outgoing power up to 4000W (peak) for starting up heavy appliances such as a refrigerator and microwave.

**Key features**

- True sine wave for sensitive devices
- Function to switch on / off the inverter via a 12V signal and to minimize battery consumption by switching off the inverter when the ignition key is switched off
- Full power for inverter and charger at extreme temperatures between -20 and +40 degrees Celsius
- Maximizes battery life
- Optional accessories
  - Control panel with 25ft cable **Item Code 056774**
  - Control panel cable
    - Item Code 056775** 7.62 (25ft)
    - Item Code 056776** 15.24 (50ft)

<b>Electrical Specifications</b>	
<b>- FREEDOM INVERTER -</b>	
<i>True Sine Wave</i>	
<b>Inverter</b>	<b>XC 230V</b>
Output power (continuous)	2000W
Peak power	4000W (>2 sec)
Output voltage	230V ±5%
Output frequency	50 - 60 Hz
Peak efficiency	91%
Continuous AC output	8.7A
Battery charger	XC 230V
Max DC output	18V
Charge current	5 - 80A
<b>General Specifications</b>	
Operating temperature	<b>-20°C to 60°C</b>
Measurements (hwxwl) mm	100 x 305 x 370
Weight	7.2 kg
<b>Item code</b>	<b>056770</b>



**Applications:**





**ULTRA-COMPACT,  
HIGH PERFORMANCE CHARGER  
FOR WORLDWIDE CHARGING**

## TRUECHARGE<sup>2</sup> BATTERY CHARGER



### Applications:



TRUECharge2 accepts 90 - 265Vac, 47-63 Hz which makes traveling abroad and handling poor-quality power a breeze. The easy-to-read display of the TRUECharge2 20A, 40A-12V and 30A-24V models can be augmented with an optional remote panel.

### Performance Features

- TRUECharge2 20 A, 40A-12V and 30A-24V are equipped with PARALLEL STACKING feature. This allows two chargers to work together to combine the output current, achieving up to 120A for large battery banks. This requires the optional Remote Panel (Item Code 056762).
- Microprocessor-controlled, multistage charging algorithms
- Settings for two and three-stage charging
- Settings for flooded, gel, AGM or lead-calcium batteries
- Battery-equalization feature
- Ability to charge batteries drained to extremely low voltage
- Optional battery temperature sensor (Item Code 056760)

### Protection Features

- Reverse battery polarity protection
- Drip-proof design
- Over and under-temperature protection
- DC over-voltage protection

### Three-Stage Charging

- Multistage charging ensures batteries receive optimum charging
- Bulk: Replaces 70-80% of the battery's state-of-charge at the fastest possible rate
- Absorption: Replenishes the remaining 20-30% of charge, bringing the battery to a full charge at a slow, safe rate
- Float: Voltage is reduced and held constant in order to prevent damage and maintain batteries at a full charge



Item Code	Model	Output Voltage	Output Power	Battery Banks	Remote Panel	Parallel Stacking	Dimensions mm	kg
056720	TRUECHARGE2 10	12V	10A	2	No	No	70x138x224	1,5
056722	TRUECHARGE2 20	12V	20A	3	Optional	Yes	70x170x250	2,2
056723	TRUECHARGE2 40	12V	40A	3	Optional	Yes	70x170x250	2,2
056733	TRUECHARGE2 30	24V	30A	3	Optional	Yes	70x170x250	2,2
056760	Battery temp. sensor	TRUECHARGE2 Alle models						
056762	Remote panel	TRUECHARGE2 Alle models except 10A						

Inverter  
12 → 230V



**XPOWER**  
INVERTER

Electrical Specifications - XPOWER INVERTERS -		<i>Modified Sinus Wave</i>		
Model	150	300	500	
Output power (continuous)	150W	300W	500W	
Surge capacity (peak)	300W	600W	1000W	
Output voltage	230V ± 5%	230V ± 5%	230V ± 5%	
Output frequency	50 ± 3Hz	50 ± 3Hz	50 ± 3Hz	
Peak efficiency	90%	90%	90%	
No load current draw	<0.18A	<0.2A	<0.3A	
Input voltage range	10-15VDC	10-15VDC	10-15VDC	
General Specifications				
Operating temperature range	0°C to 40°C	0°C to 40°C	0°C to 40°C	
Dimensions (HxWxL) mm	63x104x157	66x104x200	66x112x241	
Weight	0.65kg	0.79kg	1.2kg	
<b>Item Code</b>	<b>056700</b>	<b>056705</b>	<b>056710</b>	

Inverter  
12 → 230V

**PROwatt SWi**  
INVERTER



Electrical Specifications - PROWATT SWi INVERTER -		<i>True Sine Wave</i>		
Model	700i	1400i	2000i	
Output power (continuous)	700W	1400W	2000W	
Surge capacity (peak)	1400W	2800W	4000W	
Output voltage	230V ± 10%	230V ± 10%	230V ± 10%	
Output frequency	50 ± 0,5Hz	50 ± 0,5Hz	50 ± 0,5Hz	
Peak efficiency	90%	90%	90%	
No load current draw	<1000mA	<1000mA	<1000mA	
Input voltage range	10,5-15,5VDC	10,5-15,5VDC	10,5-15,5VDC	
General Specifications				
Operating temperature range	0°C to 40°C	0°C to 40°C	0°C to 40°C	
Low battery alarm	Audible, 11V	Audible, 11V	Audible, 11V	
Dimensions (HxWxL) mm	90x185x310	115x240x369	115x240x418	
Weight	2.7kg	4.6kg	5.5kg	
<b>Item Code</b>	<b>056740</b>	<b>056741</b>	<b>056742</b>	
<b>Optional remote panel + 25' cable</b>	<b>Item Code 056768</b>			

**Inverter**  
12 → 230V  
24 → 230V

**230V AC Current  
from your batteries !**



**PROsine  
INVERTER**

Electrical Specifications - PROsine INVERTERS -		<i>True Sine Wave</i>	
Model	1000i	1800i	
Output power (continuous)	1000W	1800W	
Surge capacity (peak)	1500W	2900W	
Peak Output Current	11A	20A	
Output voltage (at no load)	230V ± 3%	230V ± 3%	
Output frequency	50 ± 0,05Hz	50 ± 0,05Hz	
Output waveform	True sine wave (<3% THD)	True sine wave (<3% THD)	
Peak efficiency	90%	90%	
No load current draw	<0.18A	<0.2A	
Input voltage range 12V	10-16VDC	10-16VDC	
Input voltage range 24V	20-32VDC	20-32VDC	
General Specifications			
Operating temperature range	0°C-60°C	0°C-60°C	
LCD display panel	Removable; can be mounted remotely (requires remote interface kit)		
Recommended DC-fuse (12V)	175A	300A	
Recommended DC-fuse (24V)	90A	100A	
Dimensions (HxWxL) mm	115x280x390	115x280x390	
Weight	6,5kg	7,5kg	
<b>Item Code 12V</b>	<b>056750</b>	<b>056752</b>	
<b>Item Code 24V</b>	<b>056754</b>	<b>056756</b>	

CE Mark – Low Voltage Directive 2006/95/EC (EN 50178: 1997)  
EMC Directive 2004/108/EC (EN 61000-6-1:2007 EN 61000-6-3:2007)  
Automotive EMC Directive 2004/104/EC as amended by 2005/83/EC



LCD display panel, removable



Remote interface kit  
Item Code 056764



**allpa DC/DC converters**

**SMC (Switch Mode Converter) --Serie (not isolated)**  
**SMG (Switch Mode Galvanic) --Serie (with galvanic isolation)**

**A complete line of high quality DC/DC converters in a compact housing, with or without galvanic isolation.**

**SMC: not isolated**

- \* The SMC--series has a stable 12V voltage output from a 24V system. With a 13.8V output this can also be used as 12V battery charger, e.g. to load a 12V start or accessory battery in a 24V system.
- \*\* Two SMC--60 converters can be connected in parallel in order to obtain a 120A battery charger.
- \*\*\* The SMUC--series is applicable for low voltage to high voltage (e.g. 12V =>24V)

Item Code	Model	Input V	Output V	Current A	Load W	Weight Gr.	Dimensions LxWxH (mm)
056070	SMC-5*	18-35	13,8	5	69	170	68x88x49
056074	SMC-20*	20-35	13,8	20	276	477	126x88x49
056075	SMC-30*	20-35	13,8	30	414	600	151x88x49
056076	SMC-60**	20-35	13,8	60	828	1200	176x88x98
056080	SMUC 5 (Step-Up)***	5-7	12	5	60	270	98x88x49
056082	SMUC 10 (Step-Up)***	9-18	25	10	250	500	126x88x49



**allpa DC/DC Converters**

**SMG: with galvanic isolation**

- \* SMG-series: the in-and output are completely galvanic isolated, which makes them interference-proof.
- \*\* SMG 3A-series: extra-large input voltage limits, IN:7-35V. OUT: 12,6V/3A
- \*\*\* SMGH-series: to load a 24V battery from a 12V system. Input 8-18V, output 27,6V, current limit 12A, fan assist cooling. With this type the output voltage can be set with a potentiometer

**Unique!**

SMG--serie: inputs can be connected in parallel, outputs in parallel and series. SMG 200W and 360W: Adjustable output voltage ± 10%.

Item Code	Model	Input V	Output V	Current A	Load W	Weight Gr.	Cooling Fan Assist	Temp. increase 30 min at full load (°C)	Dimensions LxWxH (mm)
056090	SMG-1212-100	9-18	12,5	8	100	500	x	25	152x88x49
056091	SMG-2412-100	20-35	12,5	8	100	500	x	25	152x88x49
056094	SMG-1224-100	9-18	24	4	100	500	x	25	152x88x49
056095	SMG-2424-100	20-35	24	4	100	500	x	25	152x88x49
056100	SMG-1212-200	9-18	12,5	15	200	600	yes	30	182x88x49
056101	SMG-2412-200	20-35	12,5	15	200	600	yes	30	182x88x49
056104	SMG-1224-200	9-18	24	7,5	200	600	yes	30	182x88x49
056105	SMG-2424-200	20-35	24	7,5	200	600	yes	30	182x88x49
056107	SMG-4812-200	30-60	12,5	15	200	600	yes	30	182x88x49
056110	SMG-1212-360	9-18	12,5	25	360	1400	yes	30	160x163x64
056111	SMG-2412-360	20-35	12,5	25	360	1400	yes	30	160x163x64
056114	SMG-1224-360	9-18	24	12,5	360	1400	yes	30	160x163x64
056115	SMG-2424-360	20-35	24	12,5	360	1400	yes	30	160x163x64
056117	SMG-4824-360	30-60	24	12,5	360	1400	yes	30	160x163x64
056120	SMG-3A	7-35	12,6	1,5-3	19-38	270	x	25	86x 88x49
056122	SMGCH 12A	9-18	27,6	12	330	1400	yes	30	160x163x64

### allpa BS/BSW/BSB intelligent battery separators: a new alternative for diode battery isolators

These battery separators are microprocessor controlled high power mechanical switches. They can automatically and delayed separate batteries from each other if the voltage drops below a certain value. If the voltage of one of the batteries rises above a certain value, the BS/BSW parallels the auxiliary batteries. These battery separators can also be used as a voltage dependent switch: sometimes it is desirable that an extra input voltage only is available if the vessel (dynamo/battery charger) is running.



056150



056152

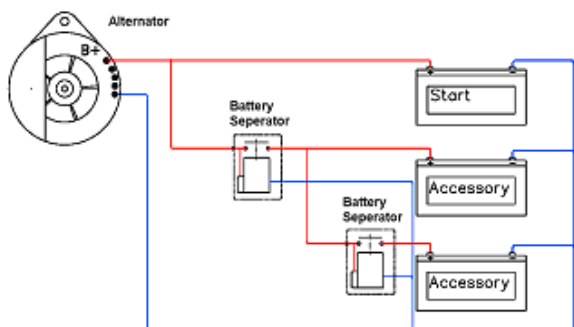

Item Code	056150	056152	056155
BS Battery Separator	BS100 Dual	BSW160 Dual	BSB250 Dual
Input Voltage autodetect	12/24V	12/24V	12/24V
Switch Current Continuous	100A	160A	250A
Switch Current Peak	250A	480A	1500A
Parallel Connect Voltage	13,2V/26,4V	13,2V/26,4V	13,2V/26,4V
Disconnect Voltage	11,8V/23,6V	12,8V/25,6V	12,8V/26,4V
Standby Current	1,5mA/1,5mA	1,8mA/2,0mA	<3mA
Protection Class	IP54	IP67	IP66
Weight	95g	470g	370g
Dimensions hxwxl	46x46x80mm	58x72x108mm	120x82x57mm

#### Features

- No loss of voltage.
- The system voltage is automatically set on 12V or 24V.
- Prioritises the starter battery; the starter battery is connected to the dynamo, other batteries can be connected to the starter battery by an intelligent battery separator.
- Unique bipolar--switching: if a charger is connected to the second battery and the battery reaches 13.2V(26.4V) for at least 7 seconds, the starter battery will be charged also.
- Because the switching process takes place without signal lines of the vehicle/vessel, the BS/BSW/BSB relays can be easily be connected, even in modern vehicles with CAN--BUS systems.

With a Diode Block (DB) more batteries can be loaded simultaneously with one dynamo. During discharging the batteries are separated by diodes. If e.g. a light battery is discharging, the starter battery will remain loaded. Thanks to the application of efficient diodes the loss of voltage is very low (0.3V). Thus the loss of voltage over the charging current dispensing diodes will be compensated.

Item Code	056170	056171	056172	056173	056174	056175	056176
Diode Battery Isolator	DB70-2C	DB90-2C	DB90-3C	DB120-2C	DB120-3C	DB160-2C	DB160-3C
Max. Charge Current (A)	50	70	70	100	100	130	130
Max. Alternator Current (A)	70	90	90	120	120	160	160
Number of Batteries	2	2	3	2	3	2	3
Connection	M6	M8	M8	M8	M8	M8	M8
Connection Compensation Diode	M4	M4	M4	M4	M4	M4	M4
Weight (kg)	0,6	0,8	1,2	0,8	1,2	1,2	1,5
Dimensions HxWxL (mm)	60x120x80	60x120x100	60x120x150	60x120x100	60x120x150	60x120x150	60x120x200



#### Battery Combining Schottky Diode (BCD)

The BCD is used to supply mission-critical equipment with a guaranteed continuously voltage, e.g. an electronic motor control system. With a BCD two or more DC power sources can be used parallel to supply critical load. If one power source goes out, the critical voltage load will not be interrupted.

Item Code	Model	IN V	OUT V	Current A	Number of Batteries IN	Weight Kg.	Dimensions LxWxH (mm)
056160	BCD 702	12/24	12/24	70	2	0,6	120 x 80 x 60
056161	BCD 703	12/24	12/24	70	3	0,8	120 x 80 x 60





**BGB 250A Battery Guard**

The BGB Battery Guard is a Bi-stabile relay which detects under- or over voltage and too high current and subsequently disconnects the users being connected to the battery and connects again if the preset value is reached. The disconnected relay will let charging current through to the battery. There are 10 programmable disconnect- and reset values. See the below table.

**Item Code 056195** BGB 250A Battery Guard

Features:

- Auto 12V/24V detection
- Adjustable under voltage value - adjustable reset voltage value
- Switching current continuous 250A - Peak 1500A
- Current consumption Active 3mA - Passive 2mA
- Reset voltage 12V - 2.6A, 24V - 5.0A
- High temperature protection
- Enclosure protection IP67
- Reverse polarity protection
- Weight 370g - Dimensions 10 x 82 x 57mm (lxwxh)
- Mounting holes Ø 5mm - Terminal strip contacts Ø 8mm
- Flange connectors (T1 & T2) 50mm2 - Faston 1,5mm2
- Both manual and remote switching possible
- LED Pilot light goes out when the battery guards is switched off

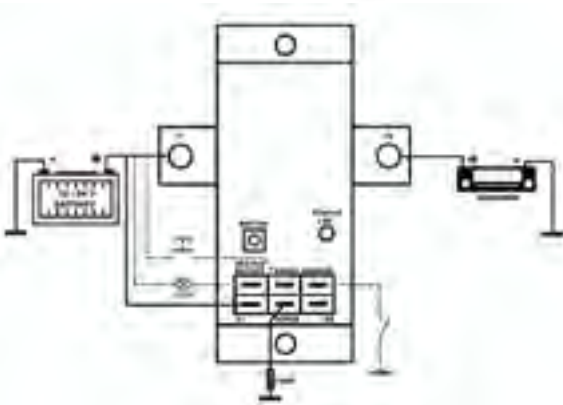

12V	Under voltage	Reset voltage	24V	Under voltage	Reset voltage
Position 1	9.50V	11.50V	Position 1	19.0V	23.0V
Position 2	10.00V	11.50V	Position 2	20.0V	23.0V
Position 3	10.00V	13.20V	Position 3	20.0V	26.4V
Position 4*	10.50V	12.00V	Position 4*	21.0V	24.0V
Position 5	10.50V	12.80V	Position 5	21.0V	25.6V
Position 6	11.25V	13.25V	Position 6	22.5V	26.5V
Position 7	11.50V	12.80V	Position 7	23.0V	25.6V
Position 8	11.50V	13.80V	Position 8	23.0V	27.6V
Position 9	11.80V	12.80V	Position 9	23.6V	25.6V
Position 10	12.80V	13.20V	Position 10	25.6V	26.8V

\* Factory settings  
Over voltage protection 12V=> 16.0V & 15.6V reset, 24V=> 32.0V & 31.2V reset.

056202



**BG-18 Battery Guard**

12/24V, maximum load 18-25A, peak current 75A. Size 62x27x9mm

**Item Code 056201**

**BG-40 Battery Guard**

12/24V, maximum load 40-45A, peak current 120A. Size 80x60x40mm

Prevent deep discharging of you battery. Disconnect load before it is not possible to start you vehicle anymore. The Battery Guard is a programmable battery watch, which disconnects the battery from non-essential loads before it is completely discharged or before it has insufficient power (programmable) left to crank the engine.

**Item Code 056202**

**GI-16 & GI-32 Corrosive Stopper, the alternative for a isolation transformer!**

In case a ship has been connected to the shore electrically corrosion can occur. To prevent this a corrosive stopper can be placed. This galvanic isolator ensures a threshold voltage of 1 Volt. Herewith the voltage difference will be lifted and corrosion of your ship will be prevented.

**Item Code 056205 GI-16** Peak 1600A/20ms, 100% waterproof (IP67). Size: 55x120x200mm, weight 1kg.

**Item Code 056209 GI-32** Peak 3200A/20ms, 100% waterproof (IP67). Size: 55x120x200mm, weight 1kg.

**Battery Guard**

**Corrosion Stopper 16A / 32A**



056205 / 056209



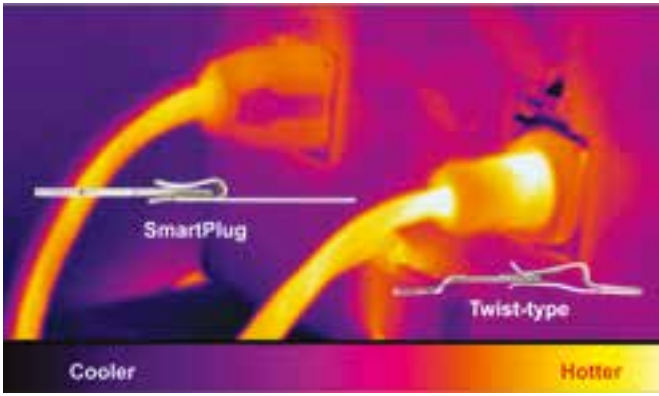

**It's SAFER!**

- weatherproof multi-point auto locking system
- straight blade connections means 20 times more contact area than twist lock systems reducing risk of over-heating

**It's "EASIER TO USE" !**

- no twisting required, once inserted, connector auto-locks in position
- no weather proof shroud required so no risk of cross threading

SmartPlug inlet, face gasket creates seal when closed, unique body shape for easy orientation of connector that automatically locks in place once inserted, power indicator lens feature

**Item Code 089350** 16A inlet white

**Item Code 089351** 16A inlet grey

**Item Code 089355** 32A inlet white

**Item Code 089356** 32A inlet grey



**SmartPlug  
Non-Metallic  
Inlet  
16A & 32A**



SmartPlug Stainless Steel inlet, face gasket creates seal when closed, unique body shape for easy orientation of connector that automatically locks in place once inserted

**Item Code 089360** 16A Stainless Steel 316 inlet

**Item Code 089361** 32A Stainless Steel 316 inlet

**SmartPlug  
Stainless Steel  
Inlet  
16A & 32A**



SmartPlug Shore Power Connector, face gasket creates seal when closed, unique body shape for easy orientation, automatically locks and seals in position

**Item Code 089365** 16A connector

**Item Code 089366** 32A connector

**Item Code 089367** 16A connector + 10m cable  
(supplied loose)

**Item Code 089368** 32A connector + 10m cable  
(supplied loose)

**SmartPlug  
Connector  
16A & 32A**



**Item Code 089369** 16A Power cable (per meter)  
3-wire 2½mm<sup>2</sup>  
Outside diameter 10mm

**Connector**





**Euro Power Plug**

Item Code 045400 CEE connector male  
 Item Code 045405 CEE connector female

IP44  
 200-250V/16A  
 2-pole + ⚡



**Right angel Power Plug**

Item Code 045440 CEE x schuko

**Connecting cable**

Connecting Kable to CEE plug  
 Item Code 045408 Schuko



**Extension cable**

Neoprene extension cable, CEE plug to CEE contra plug

Item Code 045410 10 meters  
 Item Code 045420 20 meters  
 Item Code 045430 30 meters



**Cable drum**

Neoprene cable drum, CEE plug to CEE contra plug

Item Code 045455 Only the drum  
 Item Code 045450 50 meters neoprene cable with drum



**NEW**  
**allpa Shorepower connections**

allpa On-board socket for shore power plastic housing IP56

Item Code Z2016002 16A

allpa Shorepower cable with CEE male and CEE female plug

Item Code Z2010015 16A, complete set with 15m cable

Item Code Z2010025 16A, complete set with 15m cable



CEE Plug body with cord grip. IP67

**Item Code 089314** 16A/230V

**Item Code 089324** 32A/230V

**CEE connection  
male  
16A & 32A**



CEE Shore power receptacle with mounting holes 3.13in. (79.3mm) on centers and 2.72" (69.1mm) diameter on rear portion. IP67.

**Item Code 089322** 32A/230V

Back box for inlets and receptacles is cast aluminium with corrosion resistant enamel finish and 2.75" N.P.T. hubs.

**Item Code 089323** Back box for inlets 089322

**CEE shore in  
construction  
socket  
16A & 32A**



NEMA white, U.V. resistant shore power inlet. White, weatherproof cover. Mounting holes 2.38" (60.3mm) on centers. 2 Pole - 3 Wire. IP56.

**Item Code 089300** 16A/230V

**Item Code 089320** 32A/230V

**NEMA shore  
power inlet  
16A & 32A  
Plastic**



NEMA Stainless Steel (316) shore power inlet. Transparent Interior for easy visual inspection. Water tight, self-closing cover. Mounting holes 2.38" (60.3mm) on centers. 2 Pole - 3 Wires. IP 56

**Item Code 089305** 16A/230V

**Item Code 089325** 32A/230V

**NEMA Stainless  
Steel 316 shore  
power inlet  
16A & 32A**



NEMA Power supply cord white, vinyl jacket with female end on boat side; other end blunt cut. IP56

**Item Code 089317** 16A/230V Power supply cord 7.6M

**Item Code 089316** 16A/230V Power supply cord 15.2M

**Item Code 089326** 32A/230V Power supply cord 15.2M  
3-wire 5,26mm<sup>2</sup>  
Outside diameter 26mm

**NEMA Power  
supply cord  
16A & 32A**



NEMA Yellow locking connector replacement end. IP20

**Item Code 089310** 16A/230V for Item Code 089316/17

**Item Code 089328** 32A/230V for Item Code 089326

**Item Code 089315** White Seal-Tite® cover with threaded sealing ring for use with Item 089310 and 089328 connector bodies. IP55

**NEMA  
Spare parts  
16A & 32A**





**allpa Gamba 2000** Item Code G02100  
 Continuous electric power DIN @ 50Hz  
 2.5kVA – 2kW  
 Weight (incl. soundproof hood): 46kg  
 Weight separate inverter: 5kg  
 Dims. 496x425x483mm (lxwxh)

←  
 Continuous Speed  
 3000 RPM  
 →



**Paguro 3 SY** Item Code G03103  
 Continuous electric power DIN @ 50Hz  
 3kVA – 3.0kW  
 Weight (incl. soundproof hood): 90kg  
 Dims. 636x433x547mm (lxwxh)



**Paguro 5.5 SY** Item Code G05105  
**Paguro 6000** Item Code G06100  
 Continuous electric power DIN @ 50Hz  
 5.0kVA - 4.5kW / 6kVA – 5kW  
 Weight (incl. soundproof hood)  
 = 110 kg / 130kg  
 Dims. 660x460x595mm / 684x486x595mm  
 (lxwxh)

←  
 Continuous Speed  
 3000 RPM  
 →



**Paguro 9000** Item Code G09100  
 Continuous electric power DIN @ 50Hz  
 9kVA – 8kW  
 Weight (incl. soundproof hood): 160kg  
 Dims. 745x487x615mm (lxwxh)



**Paguro 6500** Item Code G06115  
 Continuous electric power DIN @ 50Hz  
 50Hz 6.5kVA – 6kW  
 Weight (incl. soundproof hood): 170kg  
 Dims. 794x487x615mm (lxwxh)

←  
 Continuous Speed  
 1500 RPM  
 →



**Paguro 8500** Item Code G08115  
 Continuous electric power DIN @ 50Hz  
 50Hz 8.5kVA – 8kW  
 Weight (incl. soundproof hood): 200kg  
 Dims. 925x634x645mm (lxwxh)



**Paguro 4 SY** Item Code G04100  
 Continuous electric power DIN @ 50Hz  
 4kVA – 3.5kW  
 Weight (incl. soundproof hood): 83kg  
 Dims. 636x433x547mm (lxwxh)

←  
 Continuous Speed  
 3000 RPM  
 →



**Paguro 18000** Item Code G18100  
 Continuous electric power DIN @ 50Hz  
 18kVA – 18kW  
 Weight (incl. soundproof hood): 230kg  
 Dims. 995x634x645mm (lxwxh)



**Paguro 14000** Item Code G14100  
 Continuous electric power DIN @ 50Hz  
 14kVA – 14kW  
 Weight (incl. soundproof hood): 210kg  
 Dims. 885x634x645mm (lxwxh)

←  
 Continuous Speed  
 3000 RPM  
 →  
 Variable Speed  
 2000-3000 RPM



**Paguro 9000 V** Item Code G09100/V  
 Continuous electric power DIN @ 50Hz  
 9kVA – 8kW  
 Weight (incl. soundproof hood):  
 150kg + 15kg (Inverter)  
 Dims. 686x487x615mm (lxwxh) Generator  
 Dims. 250x220x330mm (lxwxh) Inverter



**Paguro 16500** Item Code G16115  
 Continuous electric power DIN @ 50Hz  
 50Hz 16.5kVA – 14kW  
 Weight (incl. soundproof hood): 320kg  
 Dims. 1300x660x750mm (lxwxh)

←  
 Continuous Speed  
 1500 RPM  
 →  
 Variable Speed  
 2000-3000 RPM



**Paguro 12000 V** Item Code G12100/V  
 Continuous electric power DIN @ 50Hz  
 12kVA – 10kW  
 Weight (incl. soundproof hood):  
 165kg + 15kg (Inverter)  
 Dims. 794x487x615mm (lxwxh) Generator  
 Dims. 250x220x330mm (lxwxh) Inverter

## Paguro Marine Diesel Generating Sets

Model	2000	3 SY	4 SY	5.5 SY	6000	9000	9000 V	12000 V	14000	18000	6500	8500	16500
Item Code	G02100	G03103	G04104	G05105	G06100	G09100	G09100/V	G12100/V	G14100	G18100	G06115	G08115	G16115
Alternator	Permanent magnet & inverter	Synchronous brushless AC	Synchronous brushless AC	Synchronous brushless AC	Synchronous brushless AC	Synchronous brushless AC	Permanent magnet & inverter	Permanent magnet & inverter	Synchronous brushless AC	Synchronous brushless AC	Synchronous brushless AC	Synchronous brushless AC	Synchronous brushless AC
Alternator Cooling	Water cooling with stainless steel - A316L - heat exchanger												
Continues Power DIN @ 50Hz	2.5 kVA	3.0 kVA	4.0 kVA	5.0 kVA	6.0 kVA	9.0 kVA	9.0 kVA	12.0 kVA	14.0 kVA	18.0 kVA	6.5 kVA	8.5 kVA	16.5 kVA
	2.0 kW	3.0 kW	3.5 kW	4.5 kW	5.0 kW	8.0 kW	8.0 kW	10.0 kW	14.0 kW	18.0 kW	6.0 kW	8.0 kW	14.0 kW
Starting Current for 2 sec (230V)	18 A	36 A	45 A	60 A	70 A	102 A	65 A	80 A	180 A	230 A	72 A	102 A	180 A
Voltage @ 50 Hz	Single Phase 230 V AC, self regulating												
Protection	IP 55	IP 55	IP 55	IP 55	IP 55	IP 55	IP 55	IP 55	IP 55	IP 55	IP 55	IP 55	IP 55
Extra output for battery charging	12 V - 8 A	12 V - 8 A	12 V - 8 A	12 V - 8 A	12 V - 8 A	12 V - 8 A	12 V - 8 A	12 V - 8 A	12 V - 8 A	12 V - 8 A	12 V - 8 A	12 V - 8 A	12 V - 8 A
Engine Model	L48N5EK9HAMA	L70N5	L70N5	L100	KDW502MG	KDW702	KDW702	KDW1003	KDW1003	KDW1404	KDW1003	KDW1404	KDW2004
No. Cylinders	1	1	1	1	2	2	2	3	3	4	3	4	4
Continues Power DIN @ 50 Hz	3.1 kW	4.5 kW	4.5 kW	5.7 kW	6.5 kW	10.0 kW	10.0 kW	17.0 kW	17.0 kW	22.0 kW	8.3 Kw	11.5 kW	18.0 kW
RPM @ 50 Hz	3000	3000	3000	3000	3000	3000	2000 - 3000	2000 - 3000	3000	3000	1500	1500	1500
Specific fuel consum. l/kW/Hour	0.35	0.35	0.35	0.35	0.35	0.35	0.35	0.35	0.35	0.35	0.35	0.35	0.35
Cooling System	Air/Water with Heat Exchanger & SS exhaust elbow with water injection												
Start/Stop-System	12 V, remote controlled												
Remote Control panel with:	hour counter, load indicator, auto stop at low oil pressure and high temperature, start blocking at running engine, 15 m extension cable												
Noise Level @ 7 m	54 dB(A)	53 dB(A)	53 dB(A)	53 dB(A)	52 dB(A)	52 dB(A)	50-53 dB(A)	50-53 dB(A)	54 dB(A)	54 dB(A)	49 dB(A)	49 dB(A)	51 dB(A)
Weight	46+5 kg	90 kg	90 kg	110 kg	130 kg	160 kg	150+15 kg	165+15 kg	210 kg	230 kg	170 kg	200 kg	320 kg
<b>N.B. 400 V 3-Phase executions available against a surcharge of 5%. From 8 kVA and 3000 rpm only.</b>													
<b>Accessoires:</b>													
<b>Item Code 71.A10</b>	Manual Shore Power Switch												
<b>Item Code 71.A11</b>	Automatic Shore Power Switch												
<b>Item Code 71.A14</b>	Automatic Start at low battery voltage Optional with timer of thermostat												
<b>Item Code 71.A19</b>	Double Pole execution for gensets with Lombardini engine												
<b>Item Code 71.91010</b>	Extra control panel with 15 m cable												
<b>Item Code 71.A20</b>	2-Way Box with 3 m cable (for use of two control panels)												
<b>Item Code 71.5410382</b>	Inline Fuel filter												

**PLEASE NOTE!!**

Starting current or starting power of electric devices of 230 & 400 V like dish washers - washing machines - air conditioners - windlasses - water pumps - com-pressors etcetera, can be the multiple value of the standard rated nominal values of these devices. The practice shows therefore that a much higher generator power is required than the rated value of an electric device to get this device started.

In most cases, apart from a higher generator power, the application of a special starting switch might be necessary.

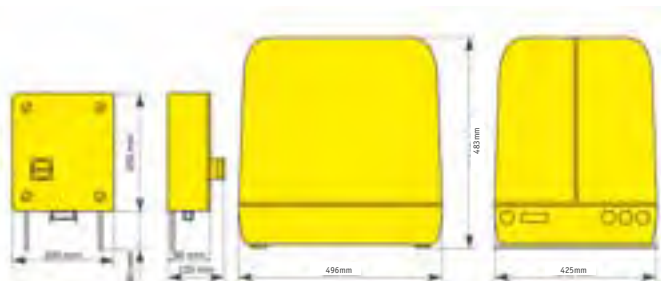

Gamba 2000

Paguro 3 SY & 4 SY  
636x433x547mm (LxWxH)

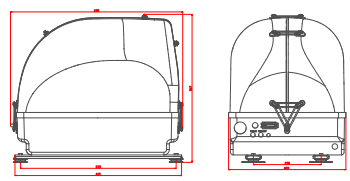

Dimensions



**Paguro LCD control panel**  
Outer diam. Ø108mm  
Bore Ø100mm  
Built in depth 38mm  
Depth incl. connections: 60mm  
Height collar 10mm  
Protection: IP65  
Temperature range: -10° to + 65°C  
8-30 VDC  
Incl. 10m cable

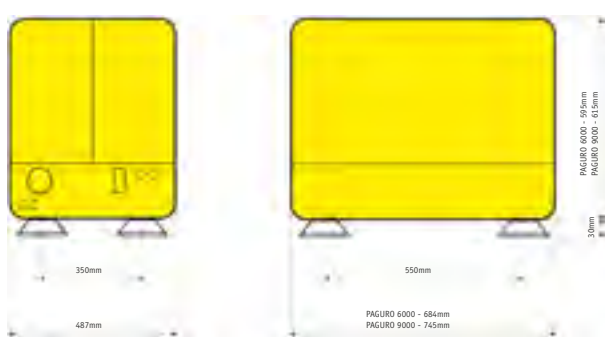

Paguro 6000 & 9000

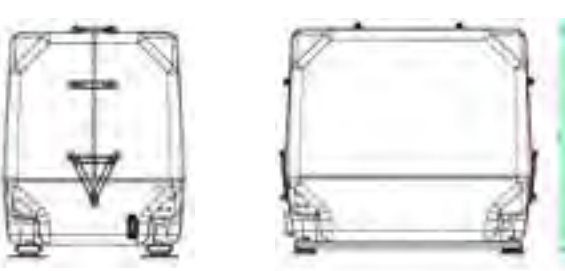

Paguro 9000 V 686x487x615mm (LxWxH)  
Paguro 12000 V 794x487x615mm (LxWxH)  
+ Inverter: 250x220x330mm (LxWxH)

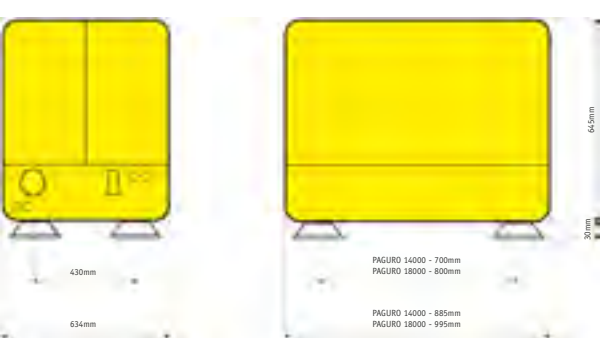

Paguro 14000 & 18000

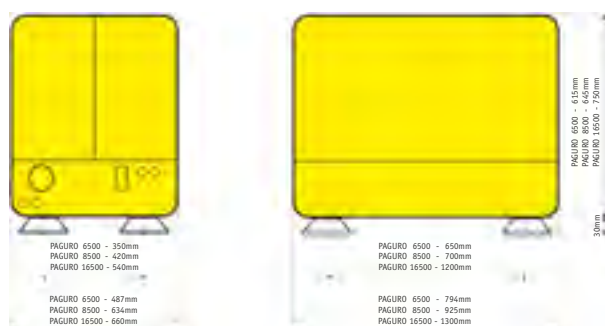

Paguro 6500, 8500 & 16500



Cooling water strainer kit



Exhaust kit

Installation Kits for Paguro Generator Sets

Type generator	Item Code Water Strainer Complete	Item Code Exhaust Complete
G02100	090151	090155
G03103	090151	090155
G04104	090151	090155
G05105	090151	090155
G06100	090152	090155
G09100	090152	090155
G09100/V	090152	090155
G12100/V	090152	090156
G14100	090152	090156
G18100	090152	090156
G06115	090152	090156
G08115	090152	090156
G16115	090152	090157

**Water Strainer Kit consist of:**  
Grated water intake, ball valve, hose pillars, water strainer, hose, hose clamps.

**Exhaust Kit consists of:**  
Exhaust hose, water lock, skin fitting, hose clamps

# allpa Gen-sets in Low Noise housing

The newly developed allpa Gen-sets are extremely durable and reliable. The combination of Mitsubishi or Deutz diesel engines and the complete aluminum housing make them also exceptionally quiet!

## 3-Phase Marine Diesel Generating Sets @ 1500 rpm - 50Hz

Item Code	Engine Model	Model	Volt DC	Volt AC	kW	kVA	Cyl.	cm <sup>3</sup>	Kg	(lxwxh)mm
022527/C	Mini 26	8 GTC	12V	400/230V	6	7.5	3	952	220	892 x 560 x 608
022531/C	Mini 33	11 GTC	12V	400/230V	8.4	10.5	3	1318	300	1032 x 580 x 668
022536/C	Mini 44	17 GTC	12V	400/230V	13.2	16.4	4	1758	344	1181 x 580 x 668
022541/C	Mini 63	25 GTC	12V/24V*	400/230V	19.5	24.3	4	2311	412	1310 x 610 x 698
022543/C	Mini 74	35 GTC	12V/24V*	400/230V	28	35	4	3331	545	1445 x 630 x 788
022548/C	SM 105	50 GTC	12V/24V*	400/230V	39	49	6	4996	795	1875 x 840 x 848
022549/C	SM81	68 GTC	12V/24V*	400/230V	54.7	68.4	6	4996	761	1903 x 840 x 848
022550/C	SDZ 109	85 GTC	24V	400/230V	68	85	4	4764	1100	1980 x 865 x 1048
022552/C	SDZ 165	115 GTC	24V	400/230V	90	112	4	4764	1117	1980 x 865 x 1048

\* 24V = option

## 1-Phase Marine Diesel Generating Sets @ 1500 rpm - 50Hz

Item Code	Engine Model	Model	Volt DC	Volt AC	kW	kVA	Cyl.	cm <sup>3</sup>	Kg	(lxwxh)mm
022525/C	Mini 26	7 GSC	12V	230V	6.6	6.6	3	952	220	892 x 560 x 608
022530/C	Mini 33	10 GSC	12V	230V	9.4	9.4	3	1318	308	1032 x 580 x 668
022535/C	Mini 44	14 GSC	12V	230V	13.8	13.8	4	1758	358	1181 x 580 x 668
022540/C	Mini 63	20 GSC	12V	230V	18.4	18.4	4	2311	426	1310 x 610 x 698
022542/C	Mini 74	29 GSC	12V	230V	28.4	28.4	4	3331	714	1670 x 740 x 837

## Digital control panel

The SCO-5 is a 12/24V LCD control panel for marine generators. It is easy and user-friendly to install and operate. It shows only symbols and numbers, so no translation is needed. It is supplied as standard with Solé Diesel marine generators up to 25 kVA. From 34kVA the more comprehensive SCO-10 panel is included. Output information via CANbus SAE J1939. IP65 protection degree. Auto Start is an option and both panels are prepared for it.

Standard:  
SCO-5



OPTION: SCO-10



### Alarm Management:

- Shut Downs (SD)
- High coolant temperature
- Low oil pressure
- Overspeed
- Overload\*
- Short circuit\*
- Overcurrent\*
- Over/Under voltage
- Over/Under frequency
- Emergency stop
- Warnings (WRN)
- High coolant temperature
- Low oil pressure
- High/Low battery voltage
- Maintenance request
- Sensor Fails (FLS)

### Display Information:

- Measurement L1-L3
- Voltage (V)
- Frequency (Hz)
- Oil Pressure (bar)
- Coolant Temperature (°C)
- Battery Voltage (V)
- Rpm
- Active Power\* (kW)
- Apparent Power\* (kVA) Current\* (A)
- History log
- Fuel level

\* The specified function needs the current transformers (Optional Equipment) for showing the information in SCO 10 panel display

\* The specified function needs the current transformers (Optional Equipment) for showing the information in SCO 10 panel display

# allpa Gen-sets

from 6.6 kVA till 112 kVA  
at 1 and 3 Phase

- @ 1500 rpm
- Plug and play!
- Durable and reliable (Basic Mitsubishi or Deutz)
- Aluminum frame and panels
- Acoustic insulation
- From 54dB (A) under full load at 7m
- Easy-clip system for easy opening
- Motor is accessible from all around
- Sincro, Mecc-alte Generator



allpa Gen-sets

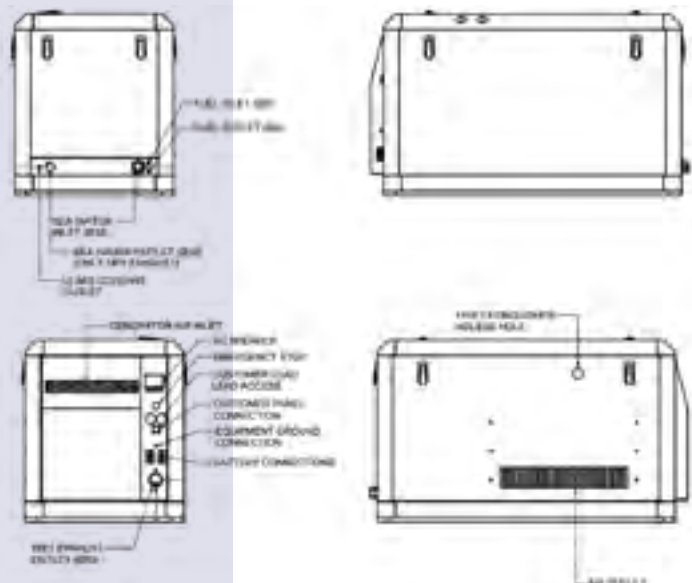
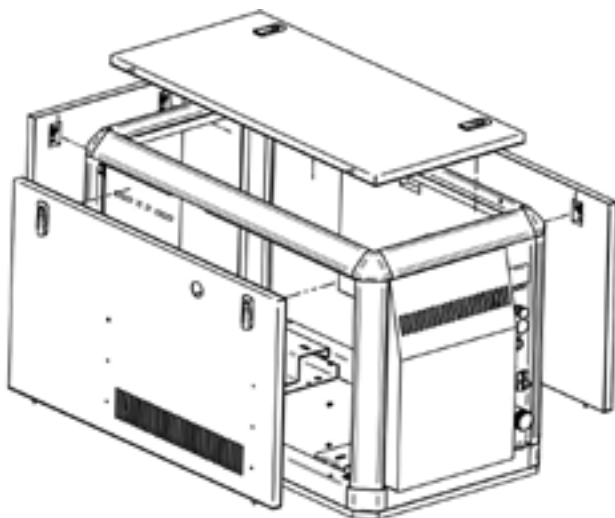

# allpa Gen-sets

## Options

Retrieval of images, DWG drawings, PDF descriptions and installation manuals is possible. This is just a small selection of all available options. Please ask a allpa dealer near you for more information.



## Optionen allpa Stromerzeuger

### Generator Control Panel SC010

Extra DigitalPanel

Kit 2nd Digital Panel

### Electrical System

Earth isolated installation 12V

Earth isolated installation 24V

### Special Kits

Auto-Start, automatic battery charge kit V2

Pression Gauge Kit

Belt Protection Alt.

Kit 2nd Fuel Filter

Boiler Kit

Kit Stop Emergency

Kit Current Transformers.100/5A 1-Phase

Kit Current Transformers. 60/5A 3-Phase

Kit Current Transformers.100/5A 3-Phase

Kit Current Transformers.150/5A 1-Phase

Pression Gauge Kit

### Exhaust System

Exhaust Flange

Kit Dry Exhaust

Kit Dry Exhaust With Flexible Pipe

Kit Dry Exh. Flexible Pipe & Silencer

### Power Take-off Pulley

Pulley 2B

Pulley 2A

Kit Power Take-off D30

Pulley 4A D138

Kit Power Take-off 2A



These generator sets are equipped with 1- or 3-Phase generators with electronic voltage regulator ensuring less than 2.5% variation under various load or temperature conditions. Low consumption and low emission engines come with a double cooling circuit with heat exchanger. The rigid high resistance frame and silent blocks guarantee a stable and quiet use.

**Features:**

- Engine cooling with heat exchanger
- 12V Electric System
- Control Panel with extension cable
- Automatic cut-off at high temperature or low oil pressure
- Self Exciting, self regulating, brushless alternator
- IP-55 Protection
- Isolation Class H
- Voltage Stability  $\pm 2.5\%$



**Solé Marine Diesel Generating Sets**



**Marine Diesel Generating Sets @ 3000 rpm - 50Hz**

Code	Motortype	Model	Phase	Volt DC	Volt AC	kW	kVA	Cyl.	cm <sup>3</sup>	Weight (kg)	(LxWxH) mm
022510	Mini 17	G-8M-3	1	12V	230V	6.4	8	2	635	145	845 x 480 x 559
022511	Mini 17	G-8T-3	3	12V	400/230V	6.4	8	2	635	145	889 x 482 x 547
022515	Mini 26	G-15M-3	1	12V	230V	12	15	3	952	225	1023 x 500 x 589
022516	Mini 26	G-15T-3	3	12V	400/230V	12	15	3	952	221	930 x 485 x 549
022520	Mini 44	G-25M-3	1	12V	230V	20	25	4	1758	320	1214 x 560 x 619
022521	Mini 44	G-25T-3	3	12V	400/230V	20	25	4	1758	320	1214 x 560 x 619

**Marine Diesel Generating Sets @ 1500 rpm - 50Hz**

Code	Motortype	Model	Phase	Volt DC	Volt AC	kW	kVA	Cyl.	cm <sup>3</sup>	Weight (kg)	(LxWxH) mm
022525	Mini 26	7GS	1	12V	230V	4.8	6	3	952	200	756 x 560 x 561
022526	Mini 26	8GT	3	12V	400/230V	4.8	6	3	952	196	756 x 560 x 561
022530	Mini 33	10GS	1	12V	230V	8	10	3	1318	280	885 x 580 x 599
022531	Mini 33	11GT	3	12V	400/230V	8	10	3	1318	272	885 x 580 x 599
022535	Mini 44	14GS	1	12V	230V	12	15	4	1758	325	1036 x 580 x 602
022536	Mini 44	17GT	3	12V	400/230V	12	15	4	1758	320	1036 x 580 x 602
022540	Mini 63	20GS	1	12/24V*	230V	20	20	4	2311	380	1139 x 610 x 662
022541	Mini 63	25GT	3	12/24V*	400/230V	19.5	24.3	4	2311	389	1139 x 610 x 662
022542	Mini 74	29GS	1	12/24V*	230V	27.2	34	4	3331	656	1507 x 740 x 781
022543	Mini 74	35GT	3	12/24V*	400/230V	27.2	34	4	3331	494	1308 x 630 x 732
022548	SM 105	50GT	3	12/24V*	400/230V	40	50	6	4996	690	1675 x 840 x 800
022549	SM81	68GT	3	12/24V*	400/230V	54.7	68.4	6	4996	750	1772 x 722 x 800
022550	SDZ109	85GT	3	24V	400/230V	68	85	6	4764	978	1775 x 865 x 958
022552	SDZ165	115GT	3	24V	400/230V	90	112	4	4764	995	1770 x 865 x 996

\* 24V = option

## NEW SELF CONTAINED UNITS

Suitable for cooling single or multiple cabins, available in 3 different models from 7.000 to 16.000 Btu/h nominal cooling capacity, the new self-contained systems (compressor, sea water condenser, evaporator and fan) and the new cooling circuit is ideal for all seasons for cooling and heating. The compact unit is especially suitable for onboard installations, allowing airflow through insulated ducting and into the conditioned space through air distribution grilles.

### Marine Air Conditioning Systems

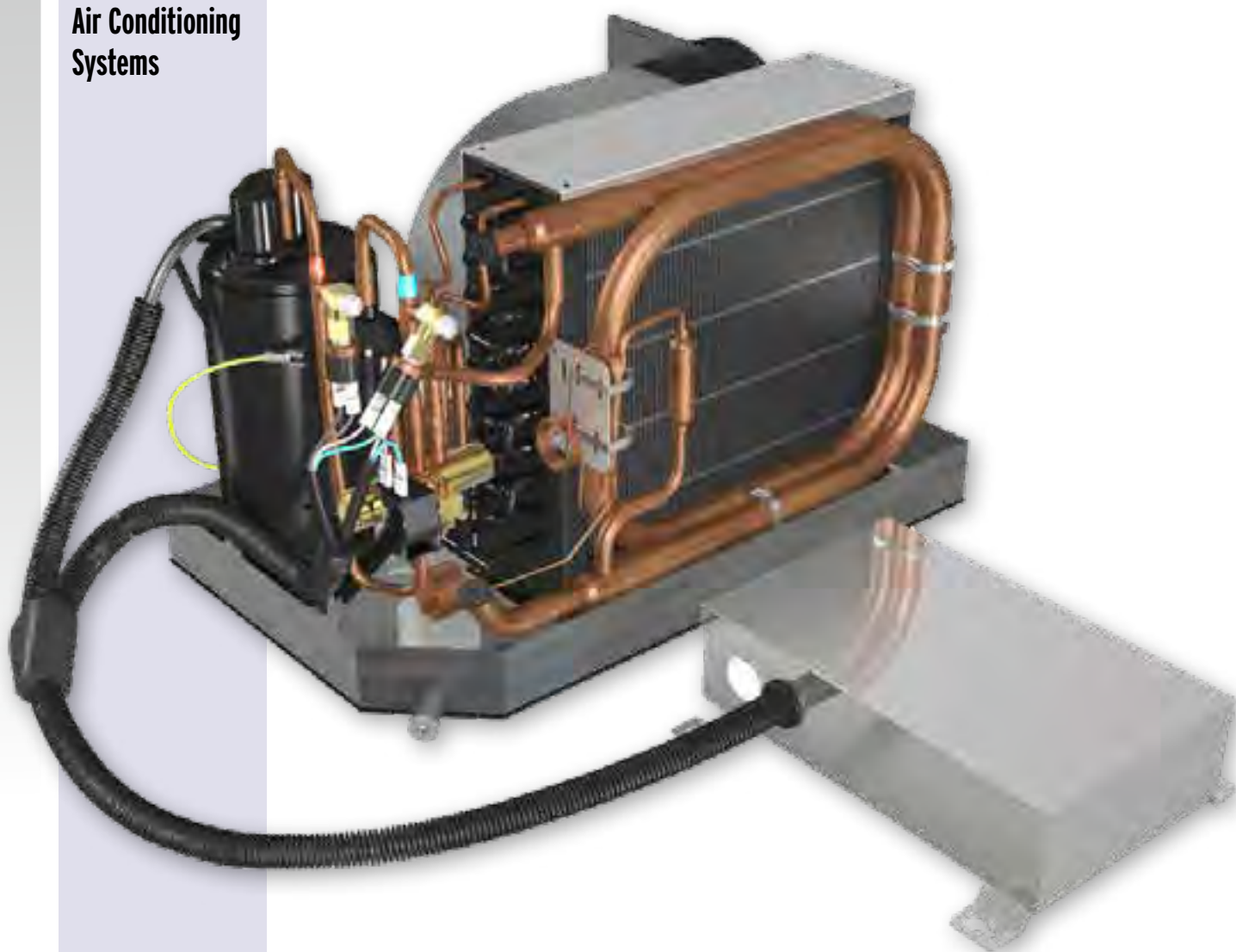

Easy-to-use OLED control panel. It can be integrated into all of the major switch component manufacturers (B-TICINO, GEWISS, VIMAR).  
 Infrared remote control (optional).  
 Dims.: 120x80 (wxh).  
 Built-in depth 31,2mm.



Model	Type 7000	Type 12000	Type 16000
Unit-Dimensions (l x w x h)	454 x 273 x 300mm	520 x 321 x 330mm	557 x 349 x 340mm
Net weight	23kg	26kg	31kg
Dimensions Electrical Box	245 x 188 x 64mm	245 x 188 x 64mm	245 x 188 x 64mm
Voltage/phase/frequency	230V/1-phase/50Hz	230V/1-phase/50Hz	230V/1-phase/50Hz
Nominal cooling capacity	7000 BTU/h	12000 BTU/h	16000 BTU/h
Nominal heating capacity	7800 BTU/h	13000 BTU/h	18000 BTU/h
Air flow	400m <sup>3</sup> /h	540m <sup>3</sup> /h	640m <sup>3</sup> /h
Air supply	Ø102mm	Ø152mm	Ø152mm
Drain hose	Ø18mm	Ø18mm	Ø18mm
Nominal power consumption (cooling)	0.6kW	0.9kW	1.1kW
Nominal power consumption (heating)	0.7kW	1.1kW	1.3kW
Nominal amperage (cooling)	2.6A	4.0A	5.0A
Nominal amperage (heating)	3.0A	4.7A	5.5A
Recommended pump flow	600l/h	900l/h	1500l/h

**OLED Digital control panel with following functions:**

- Display in °C or °F
- Circuit temperature sensor built in controlpanel
- Function mode auto/cooling/heating/ventilation
- Adjustment of ventilator speed
- Panel illumination intensity
- Starting time delay
- Switch on/switch off



**Marine Air Conditioning Systemen**

**How to choose the right system**

Cabin type	Surface*	Capacity
<b>A</b>	8 → 11m <sup>2</sup>	7000 BTU/h
	16 → 19m <sup>2</sup>	12000 BTU/h
	19 → 25m <sup>2</sup>	16000 BTU/h
<b>B</b>	5 → 7m <sup>2</sup>	7000 BTU/h
	10 → 12m <sup>2</sup>	12000 BTU/h
	12 → 17m <sup>2</sup>	16000 BTU/h
<b>C</b>	→ 6m <sup>2</sup>	7000 BTU/h
	8 → 10m <sup>2</sup>	12000 BTU/h
	10 → 13m <sup>2</sup>	16000 BTU/h

Cabin type	Description
<b>A</b>	Cabine below or on the waterline with few or no openings to outside
<b>B</b>	Cabine on or above the waterline with ports and hatches
<b>C</b>	Cabine exposed to direct sunlight with windows all around

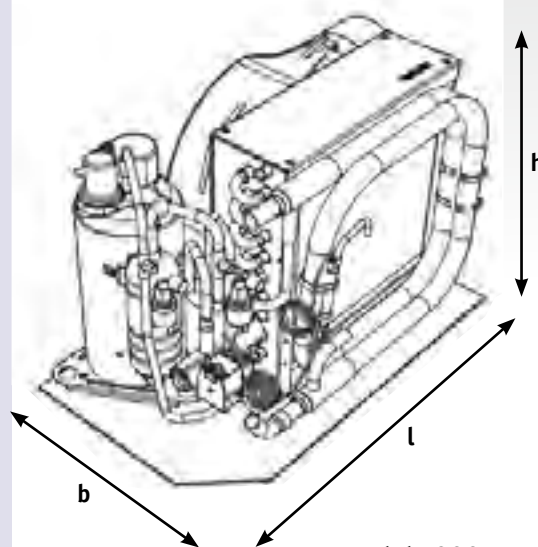

**Model 7000  
Model 12000-16000**

\*= Surface of cabin floor (an average cabin height of 2 m is calculated)



**Marine  
Air-  
Conditioning  
Systems  
Complete Kits**

Code 175890 COMPLETE KIT MODEL - 7000		
Item Code	Description Contents of Kit:	Quantity
√ 175960	Self-Contained Unit 7000 BTU/h - 230V	1
√ 175965	OLED Control panel	1
<b>Seawater-Circuit:</b>		
√ 075966	Seawater pump 230V 22l/min@1,5m	1
√ 001120C	Brass grated water intake 1/2"	1
√ 001540C	Ball valve 1/2"	2
√ 001160C	Seawater strainer 1/2"	1
√ 1004C16	Hose pillar 1/2" x 16mm	4
√ 001121C	Skin fitting 1/2"	1
√ 861623	Seawater hose 16 x 23mm with steel spiral inlay	6m
<b>Air Distribution-Circuit:</b>		
√ 175970	Insulated air distribution duct Ø102mm	5m
√ 175957	Air inlet grill (plastic) with filter 254 x 254mm	1
√ 175977	Air supply grill (plastic) 254 x 102mm incl. rear duct tube connection	1

Code 175893 COMPLETE KIT MODEL - 12000		
Item Code	Description Contents of Kit:	Quantity
√ 175963	Self-Contained Unit 12000 BTU/h - 230V	1
√ 175965	OLED Control panel	1
<b>Seawater-Circuit:</b>		
√ 075967	Seawater pump 230V 36l/min@2,0m	1
√ 001120D	Brass grated water intake 3/4"	1
√ 001540D	Ball valve 3/4"	2
√ 001160D	Seawater strainer 3/4"	1
√ 1004D20	Hose pillar 3/4" x 20mm	4
√ 001121D	Skin fitting 3/4"	1
√ 862027	Seawater hose 20 x 27mm with steel spiral inlay	8m
<b>Air Distribution-Circuit:</b>		
√ 175972	Insulated air distribution duct Ø152mm	
√ 175975	Air inlet grill (plastic) with filter 305 x 305mm	1
√ 175978	Air supply grill (plastic) 254 x 127mm incl. rear duct tube connection	1
<b>Item Code 175896</b>	<b>Set for second air outlet (to be ordered separately):</b>	
√ 175977	Air supply grill (plastic) 254 x 102mm incl. rear duct tube connection	1
√ 175970	Insulated air distribution duct Ø102mm	5m
√ 175983	3-Way (Y) Air divider Ø152/Ø152/Ø102	1

Code 175894 COMPLETE KIT MODEL - 16000		
Item Code	Omschrijving leveringsomvang:	Aantal
√ 175964	Self-Contained Unit 16000 BTU/h - 230V	1
√ 175965	OLED Control panel	1
<b>Seawater-Circuit:</b>		
√ 075968	Seawater pump 230V 54l/min@3,0m	1
√ 001120D	Brass grated water intake 3/4"	1
√ 001540D	Ball valve 3/4"	2
√ 001160D	Seawater strainer 3/4"	1
√ 1004D20	Hose pillar 3/4" x 20mm	4
√ 001121D	Skin fitting 3/4"	1
√ 862027	Seawater hose 20 x 27mm with steel spiral inlay	8m
<b>Air Distribution-Circuit:</b>		
√ 175972	Insulated air distribution duct Ø152mm	
√ 175975	Air inlet grill (plastic) with filter 305 x 305mm	1
√ 175976	Air supply grill (plastic) 305 x 152mm incl. rear duct tube connection	1
<b>Item Code 175896</b>	<b>Set for second air outlet (to be ordered separately):</b>	
√ 175977	Air supply grill (plastic) 254 x 102mm incl. rear duct tube connection	1
√ 175970	Insulated air distribution duct Ø102mm	5m
√ 175983	3-Way (Y) Air divider Ø152/Ø152/Ø102	1



**Marine  
Air-  
Conditioning  
Systems  
Complete Kits**



# Sea Classic

## Built-In Refrigerators "Sea Classic" with Internal Cooling Unit

Model	C39i	C50i	C51i	C60i	C62i	C85i	C90i
Item Code	075500	075530	075540	075550	075560	075580	075590
Total Volume (l)	38	50	51	60	62	90	87
Freezer Compartment (l)	3,6	3,6	3,6	10,2	4,5	12,8	9,1
Power Supply (Vdc)	12/24	12/24	12/24	12/24	12/24	12/24	12/24
Net Weight (kg)	17	17	17	20	18	25	22
Nominal Consumption (W)	40	40	40	40	40	40	40
Min. Installation Dims. (dxhwx)	365x400x544	360x396x634	480x390x529	410x480x619	508x460x529	415x495x789	513x480x619
Nautic Closure	yes	yes	yes	yes	yes	yes	yes
Euro-Installation Frame	075910	n/a	075900	075930	075920	075940	075930



C39i



C50i



C51i



C60i



C62i



C85i



C90i

Model	C42L	C75L	C95L	C130L
Item Code	075510	075570	075595	075600
Total Volume (l)	40l	75l	96l	133l
Freezer Compartment (l)	3,6l	10,2l	12,8l	17,1l
Power Supply (Vdc)	12/24V	12/24V	12/24V	12/24V
Net Weight (kg)	16kg	20kg	24kg	27kg
Nominal Consumption (W)	31W/h	40W/h	40W/h	45W/h
Min. Installation Dims. (dxhwx)	355x380x529	415x470x619	415x485x789	518x525x764
Nautic Closure	yes	yes	yes	yes
LED Light	No	yes	yes	yes
Euro-Installation Frame	075900	075930	n.a.	075950

## Built-In Refrigerators "Sea Classic" with External Cooling Unit

**All Sea Classic Refrigerators come with a EURO-Installation Frame as standard!**



C42L



C75L



C95L



C130L

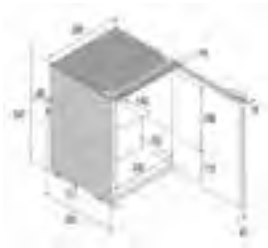

C39i

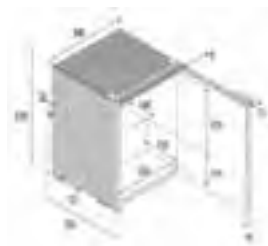

C50i

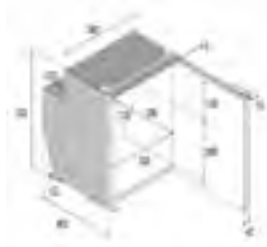

C51i



C60i



C62i



C85i



C90i

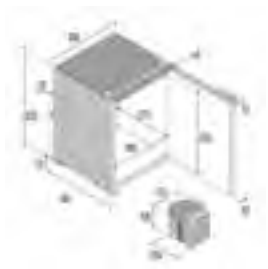

C42L



C75L

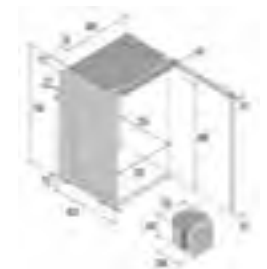

C95L



C130L



**Sea Classic Standard "Nautic Closure" with vent position**



**Euro-Installation Frame:**

Item Code	Dims (mm)	Model
075900	389x533	C42/C51
075910	399x548	C39/C49/35BT
075920	459x533	C62
075930	479x623	C60/C75/C55/C90
075940	493x793	C85
075950	533x768	C115/C130

# Sea Steel

## Stainless Steel AISI 316 Built-In Refrigerators "Sea Steel" with Internal Cooling Unit

Model	C51iX	C60iX	C62iX	C85iX	C90iX	C115iX	DP2600iX
Item Code	075542	075552	075562	075582	075592	075598	075607
Total Volume (l)	51l	60l	62l	85l	90l	115l	230l
Freezer Compartment (l)	3,6l	10,2l	4,5l	12,8l	9,8l	17,1	60l
Power Supply (Vdc)	12/24V	12/24V	12/24V	12/24V	12/24V	12/24V	12/24V
Net Weight (kg)	19,2g	22kg	20kg	27kg	25kg	30kg	62kg
Nominal Consumption (W)	40W/h	40W/h	40W/h	40W/h	40W/h	45W/h	65W/h
Nautic Closure	yes	yes	yes	yes	yes	yes	yes
LED Light	yes	yes	yes	yes	yes	yes	yes



C51iX



C60iX



C62iX



C85iX



C90iX



C115iX



DP2600iX

Model	C42LX	C75LX	C130LX
Item Code	075512	075572	075602
Total Volume (l)	42l	75l	130l
Freezer Compartment (l)	3,6l	10,2l	17,1l
Power Supply (Vdc)	12/24V	12/24V	12/24V
Net Weight (kg)	17kg	23kg	31kg
Nominal Consumption (W)	31W/h	40W/h	45W/h
Nautic Closure	yes	yes	yes
LED Light	yes	yes	yes

## Stainless Steel AISI 316 Built-In Refrigerators "Sea Steel" with External Cooling Unit



C42LX



C75LX



C130LX



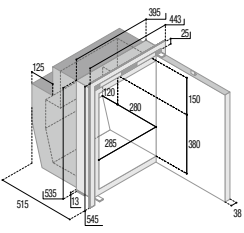

**C51iX**

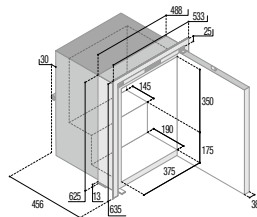

**C60iX**

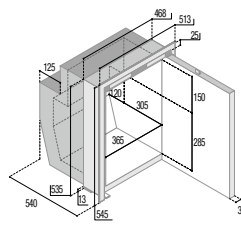

**C62iX**

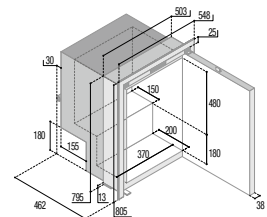

**C85iX**

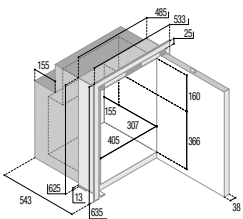

**C90iX**

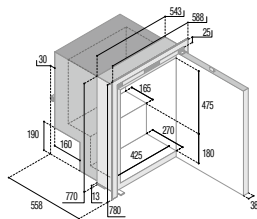

**C115iX**

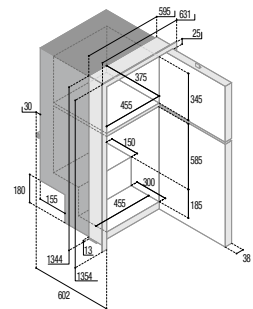

**DP2600iX**

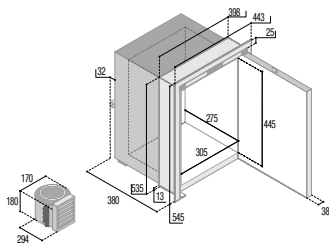

**C42LX**

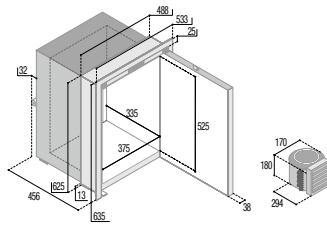

**C75LX**

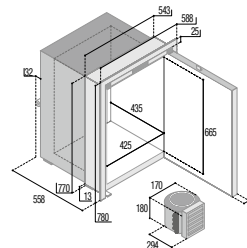

**C130LX**



**Sea Steel Standard "Steel Lock Closure"**



# SeaDrawer

## Stainless Steel AISI 316 Built-In Drawer Refrigerators "Sea Drawer"

Model	DW70RFX	DW180RFX	DW210RFX
Item Code	075800	075810	075820
Total Volume (l)	75l	80+64l	78+104l
Power Supply (Vdc)	12/24V	12/24V	12/24V
Net Weight (kg)	32kg	55kg	60kg
Nominal Consumption (W)	40W/h	45W/h	45W/h
Nautic Closure	yes	yes	yes
Cooling Unit	External	Internal	Internal



DW70RFX  
DW70BTX



DW180RFX  
DW180DTX



DW210RFX  
DW210DTX IM

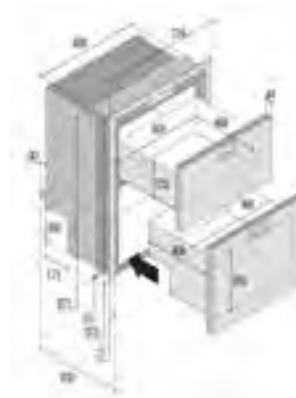

Model	DW70BTX Freezer	DW180DTX Freezer + Cooler	DW210DTX IM Freezer & Ice maker + Cooler
Item Code	075802	075812	075822
Cooling Drawer Volume (l)	-	64l	-
Freezer Drawer Volume (l)	75l	80l	104l
Freezer Drawer + Ice Cube Maker Volume (l)	-	-	78l
Power Supply (Vdc)	12/24V	12/24V	230V
Net Weight (kg)	32kg	55kg	66kg
Nominal Consumption (W)	38W/h	61W/h	140W/h
Nautic Closure	yes	yes	yes
Cooling Unit	External	Internal	Internal

## Stainless Steel AISI 316 Built-In Cooler/Freezer/ Ice maker Drawer Refrigerators „Sea Drawer“



Ice Cube Maker



Digital Thermostat with  
LED-Display

Model	DW 42	DW 51
Item Code	075801	075808
Total Volume	42l	51l incl. freezer compartment
Power Supply	12/24V	12/24V
Net Weight	22kg	26kg
Nominal Consumption	31W/h	40W/h
Nautic Closure	Yes	Yes
Cooling Unit	External	Internal

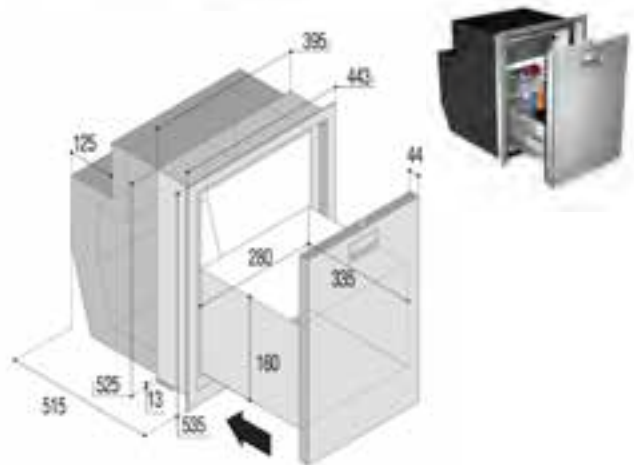
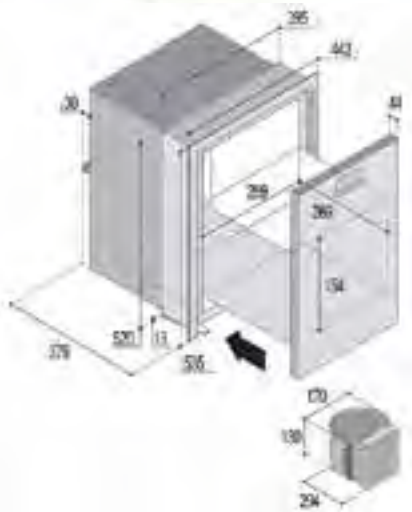

### Special Installation Refrigerator

Model	BRK35PX
Item Code	075702
Total Volume (l)	35l
Power Supply (Vdc)	12/24V
Net Weight (kg)	16,7kg
Nominal Consumption (W)	31W/h
Closure	Push-Turn

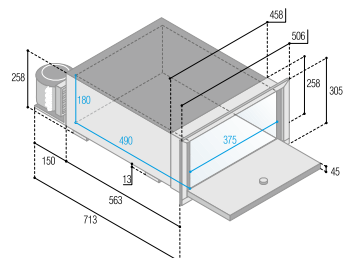

**Stainless Steel AISI 316  
Built-In „Ice Makers“**



Model	IM CLASSIC HYDRO P	IM CLASSIC REFILL P
	Direct Connection with Drinking Water System	Refill Reservoir for Mineral Water
<b>Item Code</b>	<b>075750</b>	<b>075752</b>
Total Volume(l)	24l	24l
Net Weight(kg)	26kg	26kg
Nominal Consumption (W)	140W/h	140W/h
Cooling Unit	Lower side	Lower side
Voltage	230V	230V



**IM CLASSIC  
HYDRO P**



**IM CLASSIC  
REFILL P**

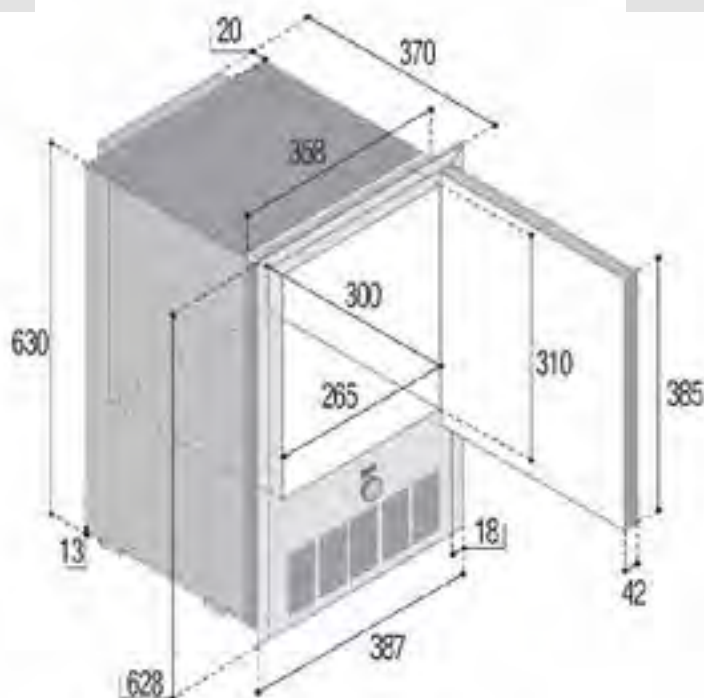

## Mobile Coolers „Sea Special“ with Internal Cooling Unit



Model	C29M	C41L	C65L
Item Code	075612	075620	075630
Total Volume (l)	29l	41l	65l
Power Supply (Vdc)	12/24V	12/24V	12/24V
Net Weight (kg)	15kg	17kg	24kg
Nominal Consumption (W)	48W/h	31W/h	45W/h
LED Light	yes	yes	yes
LED Display	No	yes	yes
Dims. (dxhwx)	530x345x390	650x385x400	765x510x458



C29M



C41L



C65L



## Special Installation Refrigerator

Model	C40L
Item Code	075506
Total Volume (l)	40l
Power Supply (Vdc)	12/24V
Net Weight (kg)	10kg
Nominal Consumption (W)	31W/h
Closure	Cover

C40L



## Automatic Converter AC/DC

Model	R11605
Item Code	075884
Input Voltage	115Vac-60Hz & 230Vac-50Hz
Output Voltage	24Vdc
Provided with Over-voltage Protection	
Suitable for all Refrigerators	



Item Code 075884

# Cooling Units



Cooling Units

Cooling Units		
Model	ND35VR-V	ND50VR-V
Item Code	075886	075887
Power Supply (Vdc)	12/24V	12/24V
For Compartments up to	90l	130l
Quick Couplings	yes	yes
Power	59W	59W
Amp.	4.91/2.46	4.91/2.46

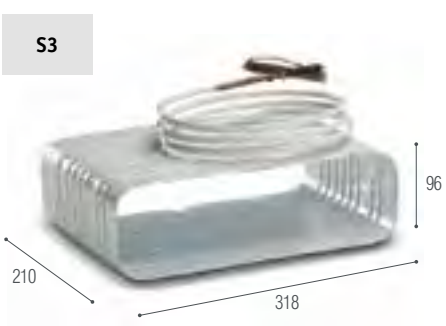

Plate Evaporators

Plate Evaporators for refrigerator with pre-filled lines		
Model	PT1	PT2
Item Code	075840	075841
For compartments up to	40l	60l
Quick-connect-coupling	yes	yes
Length tubing	1.8m	1.8m
Thermostat refrigerator version (to be ordered separately!)		
Item Code	075849	
Min.	Cut-In + 15.5°C	Cut-Off + 6.0°C
Max.	Cut-In - 6.0°C	Cut-Off - 15.5°C
Length temperature probe	1.2m	



Please note that the thermostat must be ordered separately



Box Evaporators

Box Evaporators for freezer with pre-filled lines		
Model	S8	S3
Item Code	075847	075848
For compartments up to	80l	150l
Quick-connect-coupling	yes	yes
Length tubing	1.8m	1.8m
Thermostat freezer version (to be ordered separately!)		
Item Code	075850	
Min.	Cut-In - 12.0°C	Cut-Off - 16.5°C
Max.	Cut-In - 23.0°C	Cut-Off - 28.0°C
Length temperature probe	2.0m	



Please note that the thermostat must be ordered separately



**allpa**  
marine equipment



**Galley**



**Stainless Steel built-in Oven**

**Item Code 487607**

Stainless Steel oven with grill and stove with 3 burners with glass top, all Stainless Steel inside and thermal glass door and ditto lifting cover. Suitable for fixed built-in.

Dimensions:	457 x 494 x 459mm (wxdxh)
Burners:	1x Small (1000W) 2x Medium (1750W)
Oven burner:	1900W with thermostatic gas valve
Grill burner:	1800W with thermostatic gas valve
Oven capacity:	37l
Protection:	Thermal
Ignition:	Electric 12V (on board system) for all burners
Pressure:	30mBar
Weight:	26kg

**Item Code 487039** Pot holder for 3 burners



**Stainless Steel built-in Oven**



**Item Code 487650**

Stainless Steel oven with grill, all Stainless Steel inside and thermal glass door. Suitable for fixed built-in.

Dimensions:	456 x 491 x 406mm (wxdxh)
Oven burner:	1900W with thermostatic gas valve
Grill burner:	1800W with thermostatic gas valve
Oven capacity:	37l
Protection:	Thermal
Ignition:	Electric 12V (on board system) for all burners
Pressure:	30mBar
Weight:	23kg







**Item Code 487600**

Stainless Steel oven with grill and stove with 2 burners with glass top, all Stainless Steel inside and thermal glass door. Suitable for fixed or gimbal mounting.

Dimensions: 500 x 431 x 458mm (wxdxh) \*  
 Burners: 1x Small (1000W) 1x Medium (1750W)  
 Oven burner: 1900W  
 Oven capacity: 30l  
 Protection: Thermal  
 Ignition: Piëzo (only for oven)  
 Pressure: 30mBar  
 Weight: 22kg

**Item Code 487038** Pot holder for 2 burners

\* Width without gimbal mounting

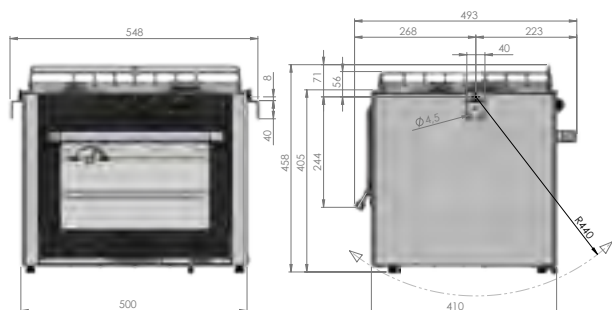

Stainless Steel built-in Oven

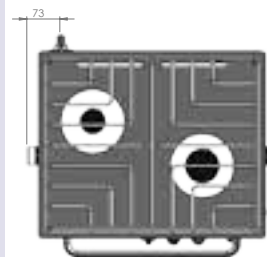

**Item Code 487603**

Stainless Steel oven with grill and stove with 3 burners with glass top, all Stainless Steel inside and thermal glass door. Suitable for fixed or gimbal mounting.

Dimensions: 500 x 431 x 460mm (wxdxh) \*  
 Burners: 1x Small (1000W) 2x Medium (1750W)  
 Oven burner: 1900W  
 Oven capacity: 30l  
 Protection: Thermal  
 Ignition: Piëzo (only for oven)  
 Pressure: 30mBar  
 Weight: 23kg

**Item Code 487039** Pot holder for 3 burners

\* Width without gimbal mounting

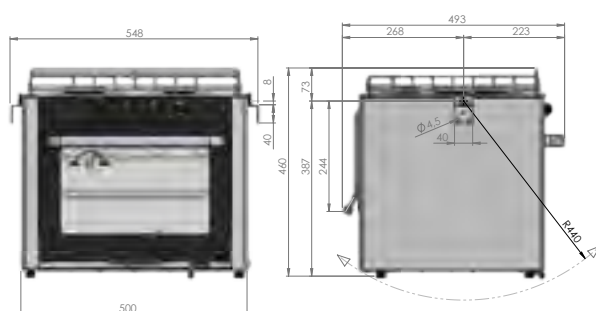

Stainless Steel built-in Oven

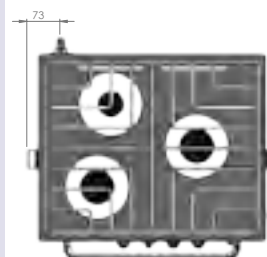



**Gas hob unit with thermic glass-plate**

**Item code 487569**

**Dimensions (lxwxh)** 325 x 290 x 80mm  
**Mounting height** 49mm from the bottom of the glass-plate  
**Weight** 5kg  
**Burners** 1x Medium (1750W)  
**Set of pan-holders option** Item Code 487035

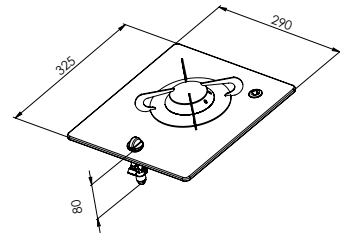

**Gas hob unit with thermic glass-plate**

**Item code 487570**

**Dimensions (lxwxh)** 365 x 200 x 80mm  
**Mounting height** 49mm from the bottom of the glass-plate  
**Weight** 5kg  
**Burners** 1x Medium (1750W)  
**Set of pan-holders option** Item Code 487035

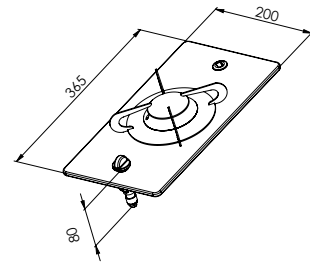

**Gas hob unit with thermic glass-plate**

**Item code 487571**

**Dimensions (lxwxh)** 380 x 280 x 80mm  
**Mounting height** 49mm from the bottom of the glass-plate  
**Weight** 8kg  
**Burners** 1x Small (1000W)  
 1x Medium (1750W)  
**Set of pan-holders option** Item Code 487036

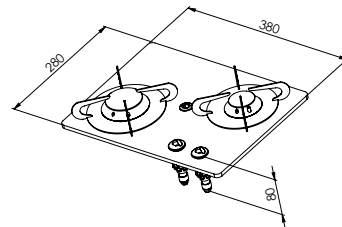

**Gas hob unit with thermic glass-plate**

**Item code 487573**

**Dimensions (lxwxh)** 500 x 300 x 80mm  
**Mounting height** 49mm from bottom of glass-plate  
**Weight** 7kg  
**Burners** 1 x Medium (1750W)  
 1x Large (3000W)  
**Set of pan-holders option** Code 487036

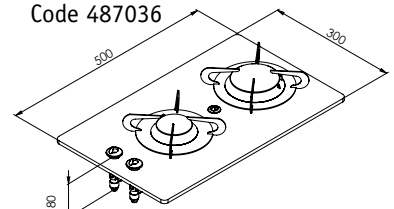

**Item code 487574**

**Dimensions (lxwx)** 505 x 410 x 80mm  
**Mounting height** 49mm from the bottom of the glass-plate  
**Weight** 7kg  
**Burners** 1x Small (1000W)  
 1x Medium (1750W)  
 1x Large (3000W)  
**Set of pan-holders option** Item Code 487037

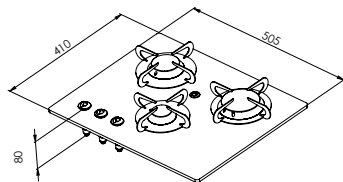

**Gas hob unit with thermic glass plate**



**Item code 487572**

**Dimensions (lxwx)** 420 x 370 x 80mm  
**Mounting height** 49mm from the bottom of the glass-plate  
**Weight** 10kg  
**Burners** 1x Small (1000W)  
 1x Medium (1750W)  
 1x Large (3000W)  
**Set of pan-holders option** Item Code 487037

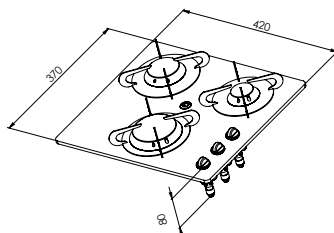

**Gas hob unit with thermic glass plate**



**Item code 487575**

**Dimensions (Øxd)** Ø340 x 80mm  
**Weight** 2,1kg  
**Burners** 1x Medium (1750W)  
**Set of pan-holders option** Item Code 487035

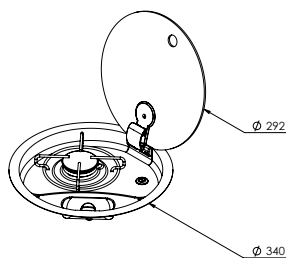

**Gas hob unit with thermic glass plate**



**Item code 487527**

**Dimensions (lxwx)** 510 x 390 x 80mm  
**Weight** 7kg  
**Burners** 1x Medium (1750W)  
 1x Large (3000W)  
**Set of pan-holders option** Item Code 487036

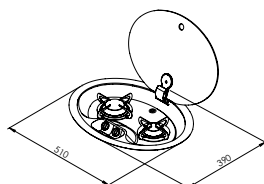

**Gas hob unit oval with cover**





**Gas hob unit with cover**

**Item code 487576**

**Dimensions (lxwxh)** 530 x 290 x 80mm  
**Weight** 4,8kg  
**Burners** 1x Small (1000W)  
 1x Medium (1750W)  
**Set of pan-holders option** Item Code 487036

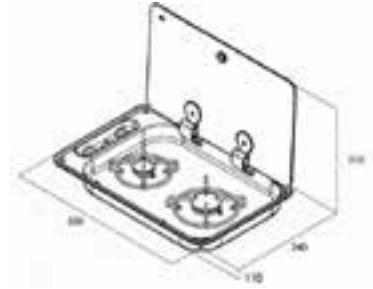

**Gas hob unit with cover**

**Item code 487577**

**Dimensions (lxwxh)** 440 x 440 x 90mm  
**Weight** 5,3kg  
**Burners** 1x Small (1000W)  
 2x Medium (1750W)  
**Set of pan-holders option** Item Code 487037

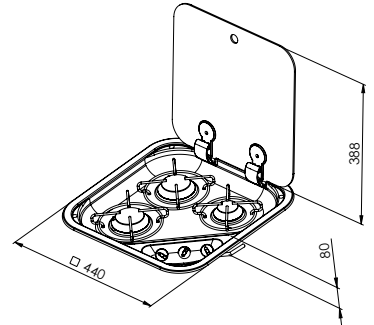

**Gas hob unit and sink with cover**

**Item code 487680**

**Dimensions (lxwxh)** 530 x 325 x (120+50)mm  
 Ø230mm  
**Weight** 5,5kg  
**Burners** 1x Medium (1750W)  
**Set of pan-holders option** Item Code 487035  
**Tap to match (option)** Item code 487106

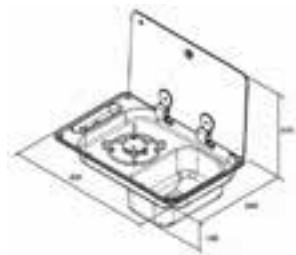

**Gas hob unit and sink with cover**

**Item code 487689**

**Dimensions (lxwxh)** 765 x 355 x (100+50)mm  
**Weight** 6kg  
**Burners** 1x Small (1000W)  
 1x Medium (1750W)  
**Set of pan-holders option** Item Code 487036  
**Tap to match (option)** Code 487106

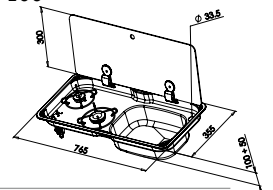

**Item code 487520**

**Dimensions (lxwxh)** 320 x 285 x 80mm  
**Weight** 2,2kg  
**Burners** 1x Medium (1750W)  
**Set of pan-holders option** Item Code 487035

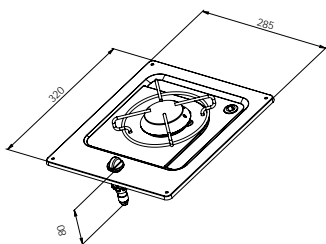

**Stainless Steel Stove**



**Item code 487523**

**Dimensions (lxwxh)** 350 x 320 x 80mm  
**Weight** 3kg  
**Burners** 2x Medium (1750W)  
**Set of pan-holders option** Item Code 487036

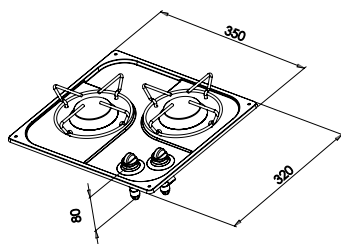

**Stainless Steel Stove**



**Item code 487522**

**Dimensions (lxwxh)** 470 x 360 x 80mm  
**Weight** 4,6kg  
**Burners** 1x Small (1000W)  
 1x Medium (1750W) 1x Large(3000W)  
**Set of pan-holders option** Item Code 487035

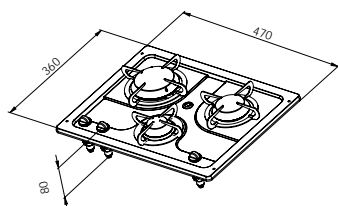

**Stainless Steel Stove**



**Item code 487529**

**Dimensions (lxwxh)** 690 x 340 x 180mm  
**Weight** 6kg  
**Burners** 1x Medium (1750W)  
**Set of pan-holders option** Item Code 487037  
**Tap** Yes, included

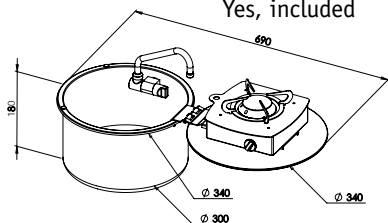

**Stainless Steel Stove with sink and cover**





**Induction cooker**

**Item Code 487150**

<b>Dimensions (lxwx d)</b>	505 x 300 x 60mm
<b>Weight</b>	5kg
<b>Burners</b>	1x Ø145mm (1200W) 1x Ø210mm (1600W)
<b>Voltage</b>	230V
<b>Set of pan-holders option</b>	Item code 487036

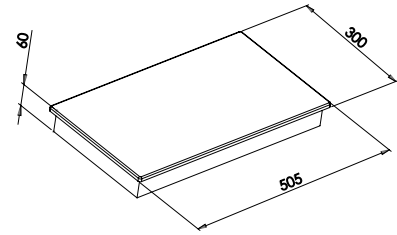

**Elektric cooker**

**Item Code 487190**

<b>Dimensions (lxwx d)</b>	505 x 285 x 60mm
<b>Weight</b>	5kg
<b>Burners</b>	1x Ø145mm (1200W) 1x Ø180mm (1800W)
<b>Voltage</b>	230V
<b>Set of pan-holders option</b>	Item code 487036

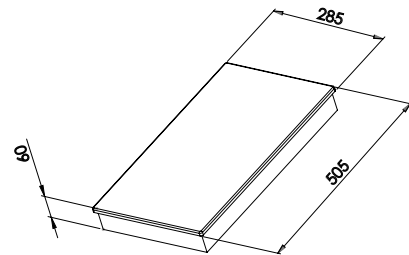

**Electric  
Barbecue**

**Item Code 487196**

<b>Dimensions (lxwx d)</b>	500 x 300 x 55mm
<b>Weight</b>	7kg
<b>Power rating</b>	2400W
<b>Voltage</b>	230V

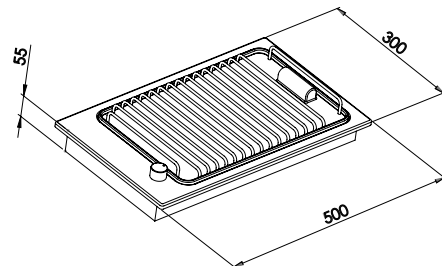

**Electric  
Grill**

**Item Code 487195**

<b>Dimensions (lxwx d)</b>	510 x 305 x 60mm
<b>Weight</b>	5,5kg
<b>Power rating</b>	2500W
<b>Voltage</b>	230V

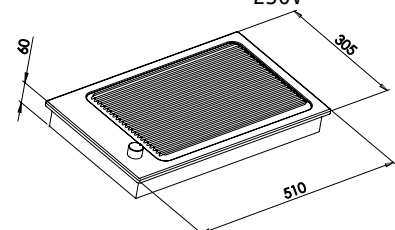

**Gas cooker units are supplied including hose connectors. All burners are fitted with thermocouple (safety valve). Dimensions are given without front controls (30mm) and gas hose fitting (40mm). Suitable for G30 Butane or G31 Propane. All gas cookers and hob units are CE-certified.**

**Item Code 487511**

<b>Dimensions (lxwxh)</b>	210 x 290 x 90mm
<b>Weight</b>	2kg
<b>Burners</b>	1x Medium (1750W)
<b>Mounting bracket option</b>	Item code 487031 half cardanic
<b>Set of pan-holders option</b>	Item code 487035

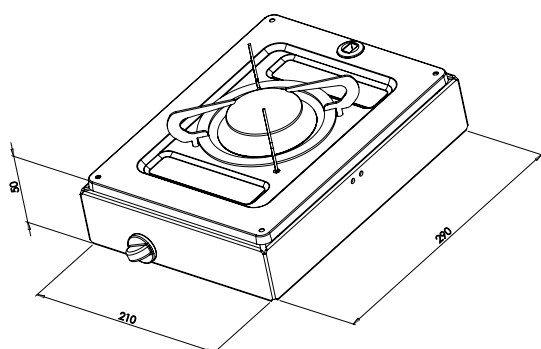

**Gas cooker dash mount**



**Item Code 487513**

<b>Dimensions (lxwxh)</b>	440 x 290 x 90mm
<b>Weight</b>	4kg
<b>Burners</b>	1x Small (1000W) 1x Medium (1750W)
<b>Mounting bracket option</b>	Item code 487031 half cardanic
<b>Set of pan-holders option</b>	Item code 487036

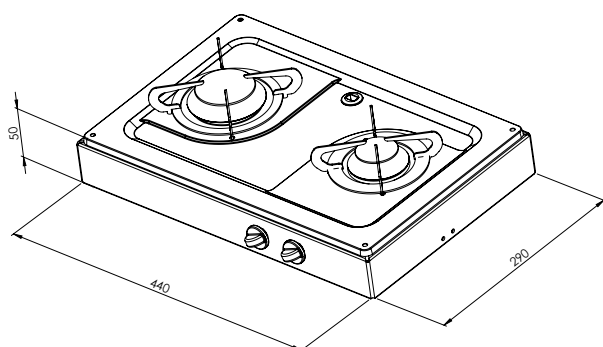

**Gas cooker dash mount**



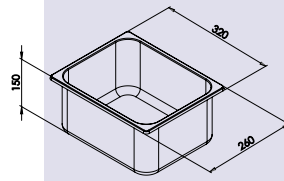

**Item Code 488007** S/S sink  
**Dimensions (lxwxh)** 320 x 260 x 150mm  
**Weight** 1kg  
**Drain** angled 25mm incl. plug

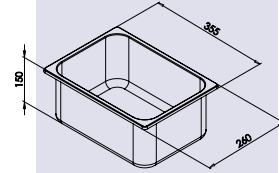

**Item Code 488008** S/S sink  
**Dimensions (lxwxh)** 355 x 260 x 150mm  
**Weight** 1,3kg  
**Drain** angled 25mm incl. plug

**S/S 304  
Sinks**

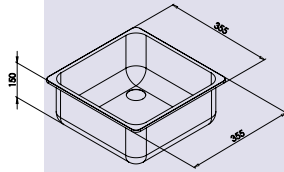

**Item Code 488010** S/S sink  
**Dimensions (lxwxh)** 360 x 360 x 150mm  
**Weight** 1,6kg  
**Drain** angled 25mm incl. plug

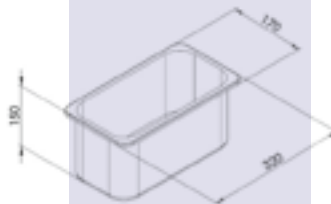

**Item Code 488011** S/S sink  
**Dimensions (lxwxh)** 320 x 170 x 150mm  
**Weight** 0,8kg  
**Drain** angled 25mm incl. plug



**Sinks  
Round**

**Item Code 488001** S/S 304 sink round  
**Item Code 488000** white Epoxy sink round  
**Dimensions (øxh)** Ø290 x 120mm  
**Weight** 0,6kg  
**Drain** angled 25mm incl. plug

**Item Code 488017** S/S 304 ink round  
**Item Code 488015** white Epoxy sink round  
**Dimensions (øxh)** Ø330 x 150mm  
**Weight** 0,8kg  
**Drain** angled 25mm incl. plug



<b>Item Code 488041</b>	glass sink without drain
<b>Dimensions (øxh)</b>	Ø280 x 110mm
<b>Weight</b>	1kg
<b>Drain for glass sink option</b>	Item Code 488049

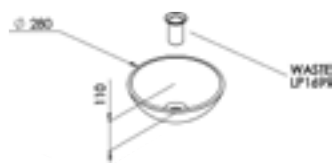

<b>Item Code 488039</b>	glass sink without drain
<b>Dimensions (øxh)</b>	Ø420 x 140mm
<b>Weight</b>	1,3kg
<b>Drain for glass sink option</b>	Item Code 488049



## Glass Sinks Round

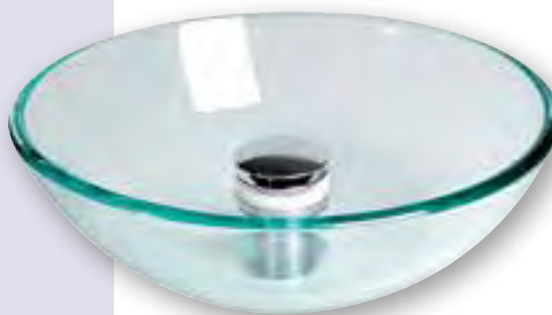
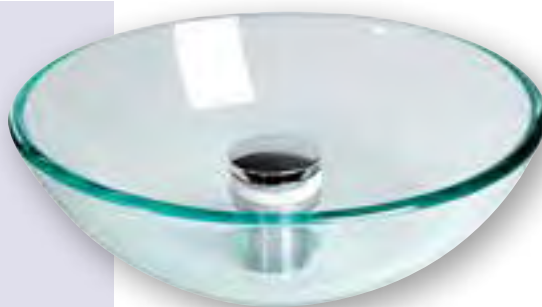

<b>Item Code 488051</b>	S/S fontain oval
<b>Dimensions</b>	A=450, B=330, C=510, D=390, E=167mm
<b>Weight</b>	1,7kg
<b>Drain (incl.)</b>	Angled drain 25mm incl. plug

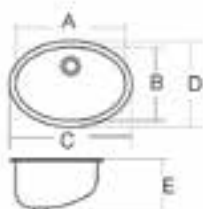

## S/S 304 Fontain



<b>Item Code 488006</b>	S/S fontain oval
<b>Dimensions (lxwxh)</b>	385 x 265 x 130mm
<b>Weight</b>	1,5kg
<b>Drain (incl.)</b>	angled drain 25mm incl. plug

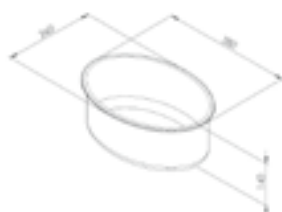



**Drains**

- Item Code 488026** Waste plug 1/4" with plug
- Item Code 488027** Waste adapter 1 1/4"
- Item Code 488028** 90° Waste adapter 1 1/4"



**Drains**

- Item Code 488025** Straight waste pipe 1 1/2" with plug
- Item Code 488020** Adapter 1 1/2" x 32mm
- Item Code 488021** Adapter 1 1/2" x 1 1/4"
- Item Code 488022** Adapter 1 1/4" x 32mm



**Drains**

- Item Code 488034** 90° Waste pipe 1 1/2" x 20 & 25mm



**Drains**

- Item Code 488029** Drain with overflow for items 488050, 488051, 488052



**Drains**

- Item Code 488049** Drain for glass sink "easy-click"



**Gas stabilizer**

- Item Code 075025** Gas stabilizer, from 50mBar to 30mBar

**Item Code 487106** Chromed plastic mixing tap. Hose connection 3/8". Warm and cold water. With switch.

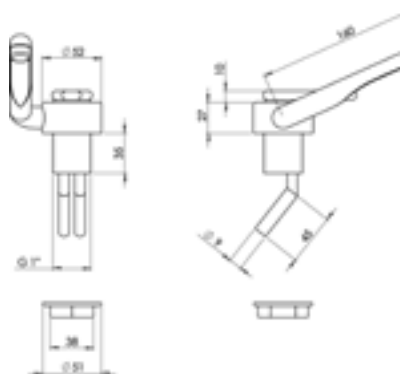

**Plastic Chromed Mixer Tab**



**Item Code 487097** Chromed plastic housing aluminum mixing tap. Hose connection 3/8". Warm and cold water.



**Chromed Mixer Tab**



**Item Code 487098** Chromed mixing tap. Hose connection 3/8" Warm and cold water.



**Chromed Mixer Tab**



**Item Code 487099** Chromed mixing tap. Hose connection 3/8" Warm and cold water.

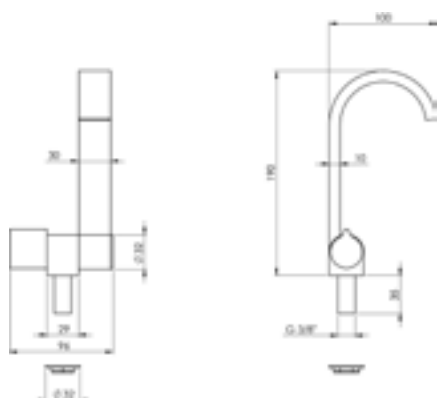

**Chromed Mixer Tab**



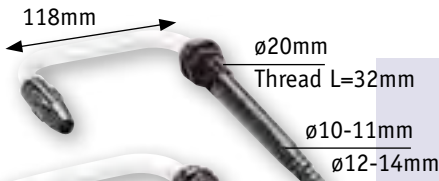

**Water Tap**

Telescopic swivel tap  
Closable  
For sinks and wash-basins

**Item Code 078240** with turn lock  
**Item Code 078241** with plug  
H= 38+87=125mm



**Water Tap with Hand Pump**

**Item Code 078242**  
Chromed plastic housing aluminum outlet swivel spout and S/S handle  
Capacity 4l/min  
Hose connection Ø10mm (3/8")  
Height 146mm, Internal depth 118mm



**Water Tap**

**Item Code 081000**  
Chromed plated tap  
With swivel spout  
Connection 1/2"



**Water Tap**

**Item Code 081001**  
Chromed plated tap with Ø10mm lowering spout  
Connection 3/8". Control right  
**Item Code 081002**  
Chromed plated tap with Ø10mm lowering spout  
Connection 3/8". Control left



**Mixer Tap**

**Item Code 081003**  
Chrome plated with Ø12mm swivel spout  
Connection 3/8"

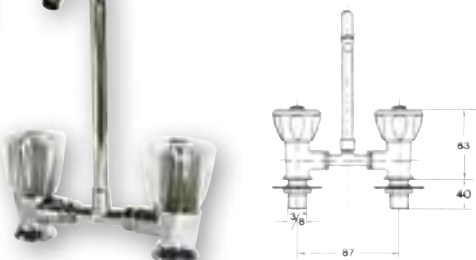

**Mixer Tap**

**Item Code 081004**  
Chrome plated with Ø10mm swivel spout  
Connection 3/8"

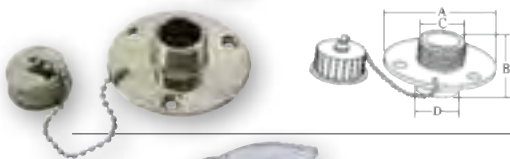

**S/S Drinking-Water Outlet**

**Item Code 078675**  
Outlet with closing cap Standard thread  
for hose connection Internal thread bottom side 1/2"  
A = 69mm, B = 35mm, C = 27mm, D = 26mm



**Mixer Tap with Shower**

**Item Code 081013**  
Combined single handed chrome plated mixer tap with extractable hand shower  
Height 124mm, Ø40mm. Hose 2m  
Height 150mm, Ø45mm, Hose 2m

**Item Code N0115130**

Chromed tap with swivelling and lowering spout  
 Connection 3/8". Dims.: A = 60mm, B = 140mm,  
 C = 180mm. Øspout = 14mm

**Chromed  
 Water Tap**

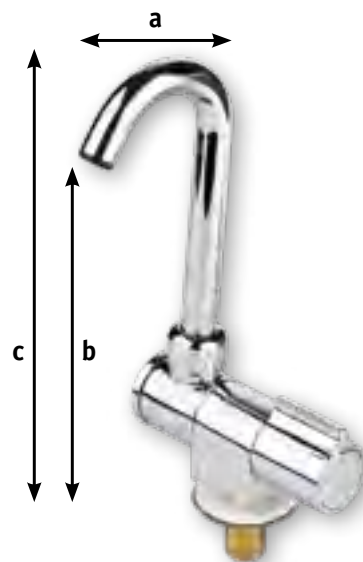

**Item Code N0103110**

Chromed mixer tap with swivelling and lowering spout  
 Connection 3/8". Dims.: A = 60mm, B = 140mm, C = 180mm,  
 D = 155mm, E = 60mm  
 Øspout=14mm

**Chromed  
 Mixer Tap**

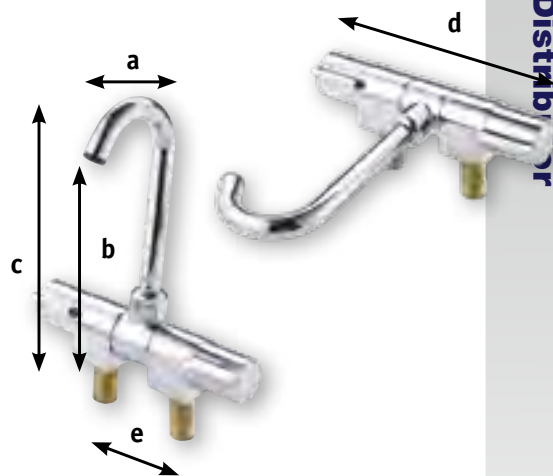

**Item Code N0114201**

Chromed mixer tap with swivelling spout  
 Connection 3/8". Dims.: A = 140mm, B = 78mm, C = 113mm

**Chromed  
 Mixer Tap**



**Item Code N0120201**

Chromed mixer tap with swivelling spout  
 Connection 3/8". Dims.: A = 200mm, B = 78mm, C = 113mm

**Chromed  
 Mixer Tap  
 with Shower**

**Item Code N0102251**

Chromed mixer tap with swivelling spout and hand shower  
 Connection 3/8". Dims.: A=195mm, B=125mm, C=148mm  
 Shower hose length 1,17m

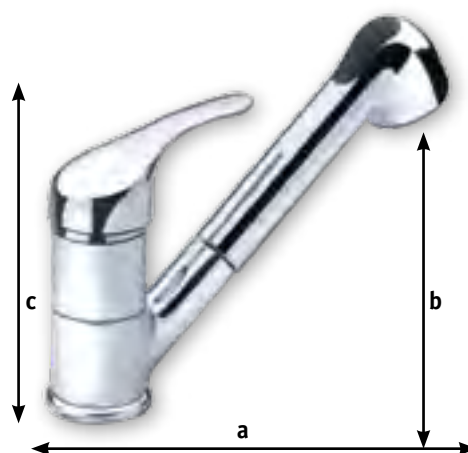



### Built-in Box with Shower

**Item Code 484259**

Complete Set with White Cover and Shower Head.  
Bore Ø65mm, Cover Ø95x100mm  
Hose Length 2.5m



### Built-in Box with Mixer Tap

Built-in Box with mixer tap.

**Item Code 484251** White Plastic Cover

**Item Code 484261** Chromed Cover



### Built-in Box with Shower and Mixer Tap

**Item Code 484250**

Built-in Box with Shower and Mixer Tap. White Plastic. Bulkhead or Deck Mount.  
Hose Length 2.5m



### Inbouwkast met water in- of uitlaat

Built-in Box with quick connect coupling ("Gardena") for water inlet or outlet.

**Item Code 484253** Inlet, White Plastic

**Item Code 484263** Inlet, Chromed Plastic

**Item Code 484252** Outlet, White Plastic

**Item Code 484262** Outlet, Chromed Plastic



### Shower head

Shower head. Fits Built-in Box **Item Code 484245**.

**Item Code 484234** Shower Head. White Plastic

**Item Code 484235** Shower Head. Chromed Plastic

**Item Code 484245** Built-in Box only



### Shower head

Shower head. Fits Built-in Box **Item Code 484246**.

**Item Code 484230** Shower Head. White Plastic

**Item Code 484246** Built-in Box only

Shower Hose, white

<b>Item Code 484239</b>	2.5 meter	Connection 3/4"
<b>Item Code 484240</b>	5 meter	Connection 3/4"



**Shower Hose**

Self-priming shower kit with electronic pressure switch and accessories.

<b>Item Code 06150</b>	12/24V, 7,5A, 10l/min 2.0bar
------------------------	------------------------------



**allpa Water pressure system with shower kit**

Stainless steel 316 built-in cabinet with hot/cold mixer.

<b>Item Code N0132200</b>	Installation size Ø76mm
---------------------------	-------------------------

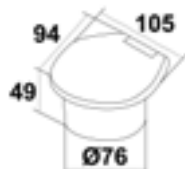

**Mixer tap with stainless steel built-in cabinet**



Complete set, High-quality shower head and Stainless steel 316 built-in cabinet. Hose length 2.5 meters.

<b>Item Code N0132258</b>	Installation size Ø76mm
---------------------------	-------------------------

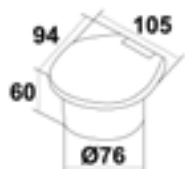

**Hand shower with stainless steel built-in cabinet**





**allpa**  
marine equipment



**Sanitair**



**allpa Space Saver Manual Marine Toilet**

- Smallest and lightest on the market!
- Manual Pump may be mounted left or right
- Vitreous white china bowl
- Corrosion resistant materials throughout
- **New: Now with Soft-Close Plastic Seat and Cover!**
- Very hygienic
- Inlet Ø19mm, Outlet Ø38mm

allpa  
Space Saver  
Manual Marine  
Toilet

Code	Weight	A	B	C	D	E	F	
259015	8kg	285	630	215	425	450	170	mm

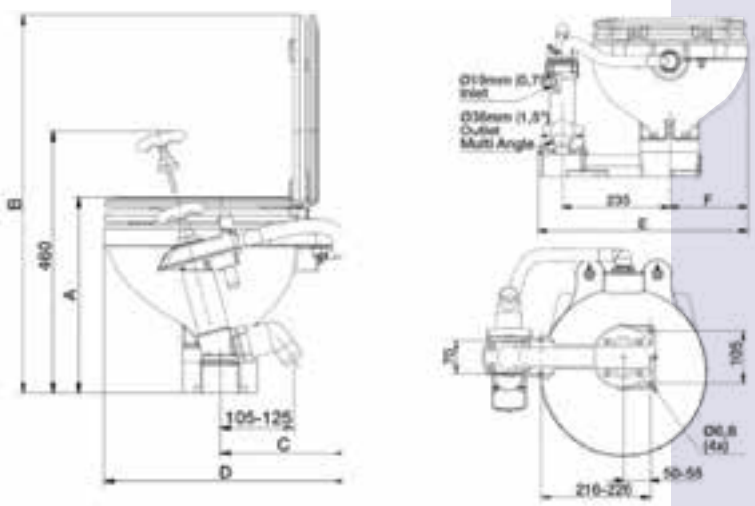

"Soft-Close" Seat and Cover

**Johnson AquaT Manual Marine Toilets**

- Manual Pump may be mounted left or right
- Vitreous white china bowl
- Corrosion resistant materials throughout
- **New: Now with Soft-Close Plastic Seat and Cover!**
- Very hygienic
- Inlet Ø19mm, Outlet Ø38mm

Johnson AquaT  
Manual Marine  
Toilet

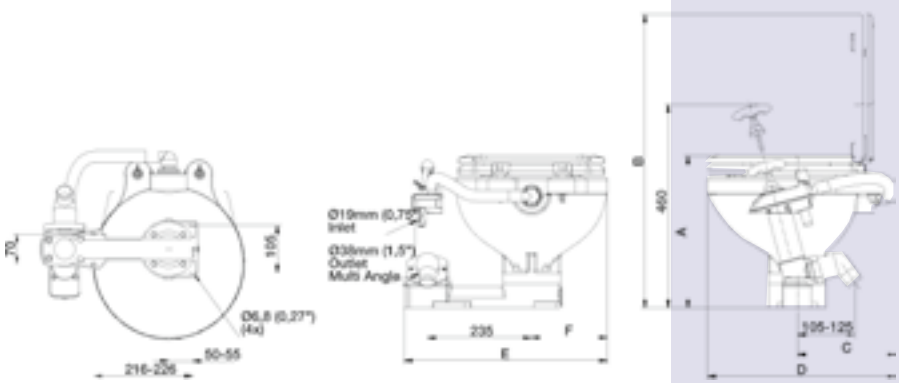

➤ Johnson Pump®



6680-47229-01



6680-47230-01



"Soft-Close" Seat and Cover

Item Code	Description	Weight	A	B	C	D	E	F	
6680-47229-01	Compact	9,6kg	345	650	215	425	450	170	mm
6680-47230-01	Comfort	11kg	340	705	275	490	470	185	mm



allpa  
*Space Saver*

**Electric  
Marine Toilet**



"Soft-Close" Seat and Cover

**allpa Space Saver Electric Marine Toilet**

- Smallest and lightest on the market!
- Manual Pump may be mounted left or right
- Vitreous white china bowl
- Corrosion resistant materials throughout
- **New: Now with Soft-Close Plastic Seat and Cover!**
- Very hygienic
- Inlet Ø19mm, Outlet Ø25mm
- Complete with control panel (Item Code 259092)

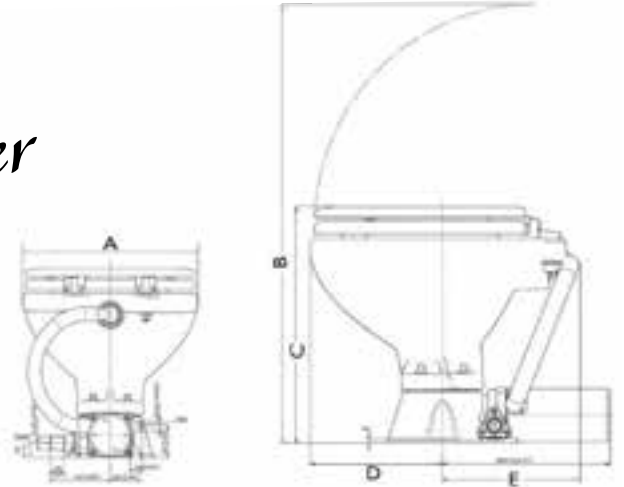

Item Code	Weight	Volt	Amp	A	B	C	D	E	
259017	9kg	12V	13A	345	650	310	209	216	mm
259019	9kg	24V	7A	345	660	320	209	216	mm



allpa®  
*Standard*

**Electric  
Marine Toilet**



Incl.  
Control Panel



"Soft-Close" Seat and Cover

**allpa Standard Electric Marine Toilets**

- One self priming pump with marcerator for flushing and disposal
- Hygienic Vitreous porcelain bowl
- **New! Now with "Soft-Close" plastic Seat and Cover!**
- Corrosion resistant materials throughout
- Low water consumption(2,5l/flush)
- Long Service life
- Complies with ISO 8846 ignition protection and EN 55014 EMC
- Inlet: Ø19mm (3/4"), Outlet: Ø25mm (1")
- Motor: 13A - 12V or 7A - 24V
- Dims. Control panel: 62 x 104mm, hole pitch 45 x 83mm

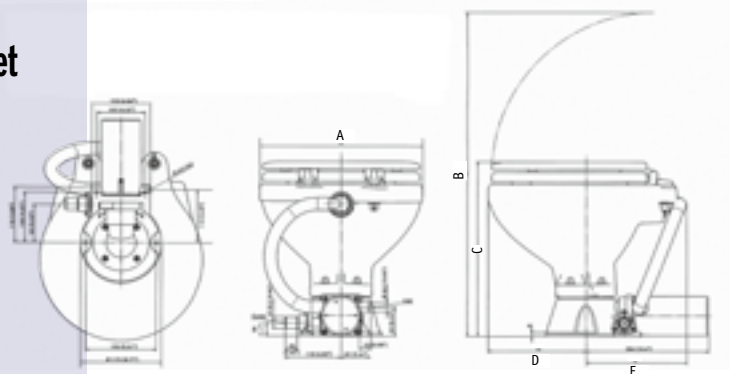

Item Code	Description	Weight	Volt	Amp	A	B	C	D	E	
66-80-47435-01	Compact	12,8kg	12V	13A	345	629	373	209	216	mm
66-80-47435-02	Compact	12,8kg	24V	7A	345	629	373	209	216	mm
66-80-47436-01	Comfort	14,6kg	12V	13A	366	747	380	220	275	mm
66-80-47436-02	Comfort	14,6kg	24V	7A	366	747	380	220	275	mm

**allpa electric Evolution Toilet**

- A new range of toilets with improved performance (+50%) and design and a lower noise level (-30%) compared to standard electric toilets.
- Hygienic vitreous porcelain bowl
- One self-priming High Performance pump with impeller and macerator: Drainage up to 4m in height and at a distance of 40m
- Discharge connection 1" (25mm) or 1-1/2" (38mm) 360° orientable, complete with duck valve
- Including control panel
- The running cycle is completely automatic



"Soft-Close"  
Plastic Seat and Cover

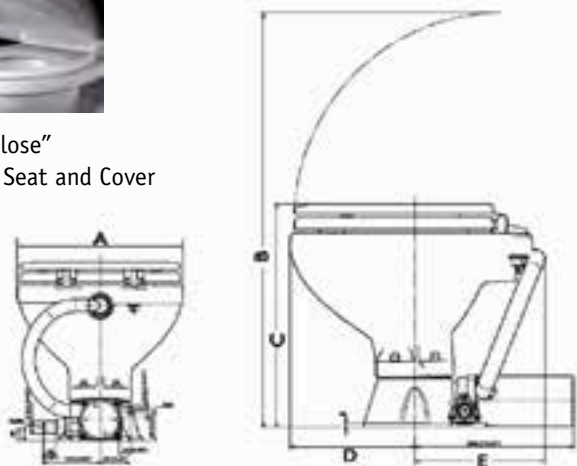

**allpa electric Evolution Toilet**



Item Code	Description	Weight	Volt	Amp.	A	B	C	D	E	
259010	Compact	10kg	12V	17A	345	692	373	209	216	mm
259011	Compact	10kg	24V	8A	345	692	373	209	216	mm

**Laguna Toilet "Standard" Electric Marine Toilet**

- One self priming pump with marcerator for flushing and disposal
- Hygienic vitreous porcelain bowl
- Corrosion resistant materials throughout
- **New! Now with "Soft-Close" plastic Seat and Cover!**
- Very hygienic
- Inlet Ø19mm (¾"), Outlet Ø38 & 25mm (1-1/2 & 1")
- Dims. Control panel: 62 x 104mm, hole pitch 45 x 83mm



"Soft-Close" Plastic Seat and Cover

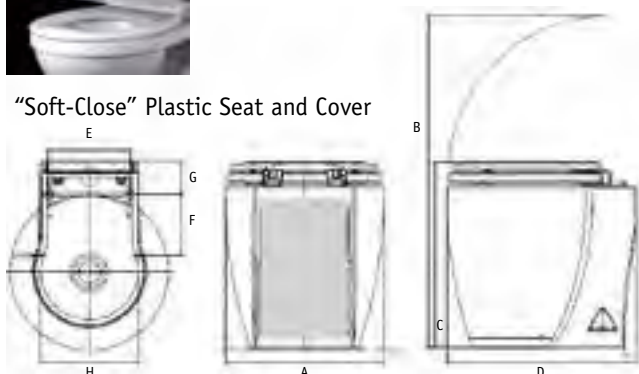

**Laguna Electric Marine Toilet Standard**



259092



Item Code	Description	Weight	Volt	Amp	A	B	C	D	E	F	G	H	
259025	Standard	19,5kg	12V	19A	343	716	403	410	180	133	92	Ø211	mm
259026	Standard	19,5kg	24V	10A	343	716	403	410	180	133	92	Ø211	mm





66-80-47231-01

**Aqua-T Silent-Electric Marine Toilet**

- Fully Automatic Low Noise Flush System!
- Separated water supply pump and discharge macerator pump
- Hygienic vitreous porcelain bowl
- Corrosion resistant materials throughout
- New! Now with "Soft-Close" plastic Seat and Cover!
- Very hygienic
- Inlet Ø19mm (3/4"), Outlet Ø38 & 25mm (1-1/2" & 1")
- Dims. Control panel: 62 x 104mm, hole pitch 45 x 83mm

**AquaT Silent Electric Marine Toilet**



66-80-47232-01

Incl. Control Panel (6681-36105-01)

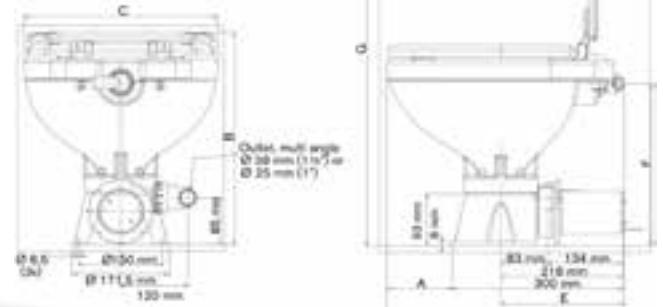

art.	Omschrijving	Gewicht	Volt	Amp	A	B	C	D	E	F	G	
66-80-47231-01	Compact	9,6kg	12V	13A	120	390	335	420	215	290	700	mm
66-80-47231-02	Compact	9,6kg	24V	7A	120	390	335	420	215	290	700	mm
66-80-47232-01	Comfort	11kg	12V	13A	190	385	365	490	275	280	755	mm
66-80-47232-02	Comfort	11kg	24V	7A	190	385	365	490	275	280	755	mm



"Soft-Close" Seat and Cover

(259097)



**Laguna Electric Marine Toilet Hydro-Vacuum**

**Laguna "Hydro-Vacuum" Electric Marine Toilet**

- Fully Automatic Low Noise Flush System!
- Separated water supply pump (9l/min) and discharge macerator pump
- Low water consumption (1 to 2.5l)
- Electric Solenoid Valve included (for connection to a pressurized drinking water system)
- Hygienic vitreous porcelain bowl
- Corrosion resistant materials throughout
- New! Now with "Soft-Close" plastic Seat and Cover!
- Very hygienic
- Inlet Ø19mm (3/4"), Outlet Ø38 & 25mm (1-1/2" & 1")
- Control Panel prepared for waste tank indicator by LED's on the panel: Full - 3/4 - Empty
- Dims. Control panel: 123 x 80 x 8mm, cut-out size 78 x 54mm
- Pre-wired: L=500mm
- Waste max head: 7m / Distance 70m

**Item Code 259231** E-Valve 12V, 1/2"

**Item Code 259232** E-Valve 24V, 1/2"

**Item Code 259229** Flushing pump 12V

**Item Code 259230** Flushing pump 24V

**Item Code 259239** Filter

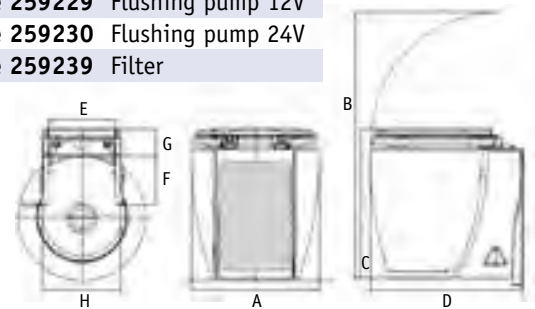

"Soft-Close" Seat and Cover

Item Code	Description	Weight	Volt	Amp	A	B	C	D	E	F	G	H	
259027	Hydro-Vacuum	20,5kg	12V	15A	343	716	403	410	180	133	92	Ø211	mm
259028	Hydro-Vacuum	20,5kg	24V	8A	343	716	403	410	180	133	92	Ø211	mm

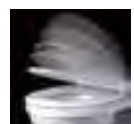

## Aqua-T Premium Silent-Electric Marine Toilet

- Standard and Low models, both with straight or bevelled back
- Fully Automatic Low Noise Flush System!
- Separated water supply pump and discharge macerator pump
- Hygienic vitreous porcelain bowl
- Corrosion resistant materials throughout
- **New! Now with "Soft-Close" plastic Seat and Cover!**
- Very hygienic
- Inlet  $\varnothing 19\text{mm}$  (3/4"), Outlet  $\varnothing 38$  &  $25\text{mm}$  (1-1/2" & 1")
- Dims. Control panel: 62 x 104mm, hole pitch 45 x 83mm



"Soft-Close" Seat and Cover

Item Code	Description	weight	Volt	Amp
66-80-47233-01	Silent Premium, low, straight	23,5kg	12V	16A
66-80-47233-02	Silent Premium, low, straight	23,5kg	24V	10A

Item Code	Description	weight	Volt	Amp
66-80-47235-01	Silent Premium, standard, straight	24,5kg	12V	16A
66-80-47235-02	Silent Premium, standard, straight	24,5kg	24V	10A

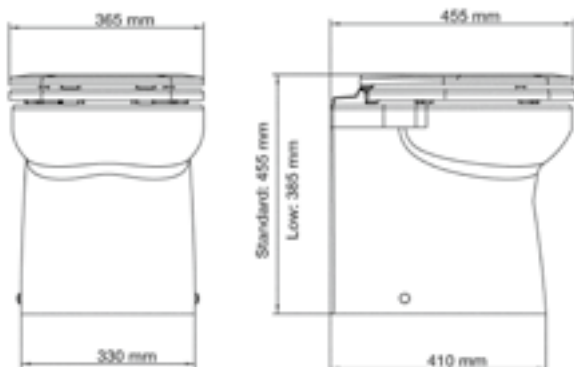

66-80-47233



## AquaT Premium Silent Electric Marine Toilet

66-80-47235



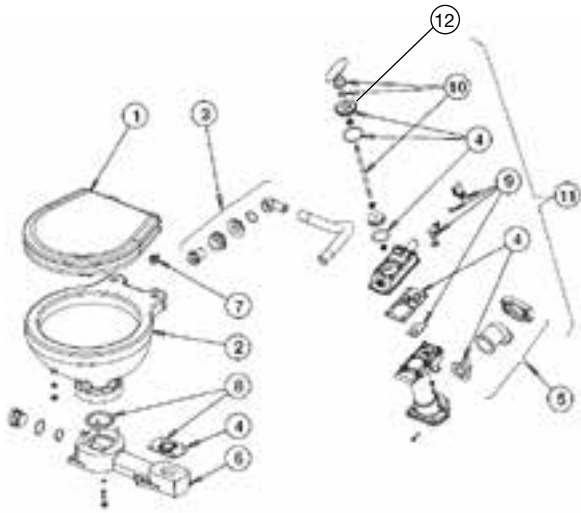

Johnson AquaT Manual Toilet + allpa Space Saver Manual Toilet		
Ref.	Description	Item Code
1	Soft-Close Seat+Cover, white, Compact	66-81-47241-01
	Soft-Close Seat+Cover, white, Comfort	66-81-47241-02
2	Vitreous China Bowl, Compact	66-81-47245-01
	Vitreous China Bowl, Comfort	66-81-47245-02
3	Inlet 90°, right	187020
	Inlet 90°, left	187020/L
4	Complete Gasket Kit	66-81-47242-01
5	Outlet Kit 90°	66-81-47246-02
6	Plastic Base	66-81-47243-01
7	Hinge Kit	66-81-47267-01
8	Base Gasket Kit	66-81-47268-01
9	Flushing Handle Kit	66-81-47269-01
10	Pump Handle Kit	66-81-47244-01
11	Complete Manual without Outlet knee	66-81-47239-01
-	Drain Plug Toilet Base	259119
-	"Space-Saver" plastic "Soft-Close" Seat+Cover	259121
-	"Space-Saver" vitreous china Bowl	259087
12	Lipseal	66814745301
-	Spare check valve (duck mouth)	187021

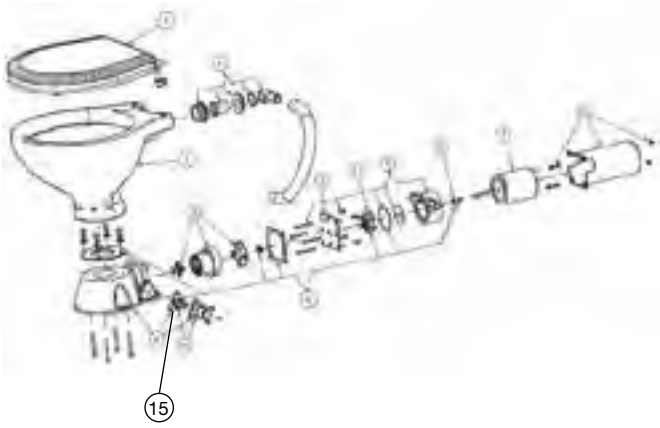

Johnson AquaT Standard-Electric Toilet + allpa "Space Saver" Electric Toilet		
Ref.	Description	Item Code
1	Soft-Close Seat+Cover, white, Compact	66-81-47241-01
	Soft-Close Seat+Cover, white, Comfort	66-81-47241-02
2	Vitreous China Bowl, Compact	66-81-47245-01
	Vitreous China Bowl, Comfort	66-81-47245-02
3	Inlet Kit 90°	66-81-47246-01
4	Plastic Base Kit	66-81-47446-01
5	Macerator Kit	66-81-47447-01
6	Pump Body Group	66-81-47448-01
	Motor group, 12V	66-81-47449-01
	Motor Group, 24V	66-81-47449-02
8	Pump Flange	66-81-47450-01
9	Complete Gasket Kit	66-81-47451-01
10	Outlet Kit, straight	66-81-47452-01
	Drain connection for electric toilet, 90°	187014
11	Impeller	66-09-847B
12	Lipseal	66-81-47453-01
13	Motor Hood Kit	66-81-47443-01
14	Conversion Kit, 12V	66-81-47442-01
	Conversion Kit, 24V	66-81-47442-02
-	Seat+Cover "Space-Saver" Plastic "Soft-Close"	259121
-	"Space-Saver" Vitreous China Bowl	259087
15	Triangle Valve	187007

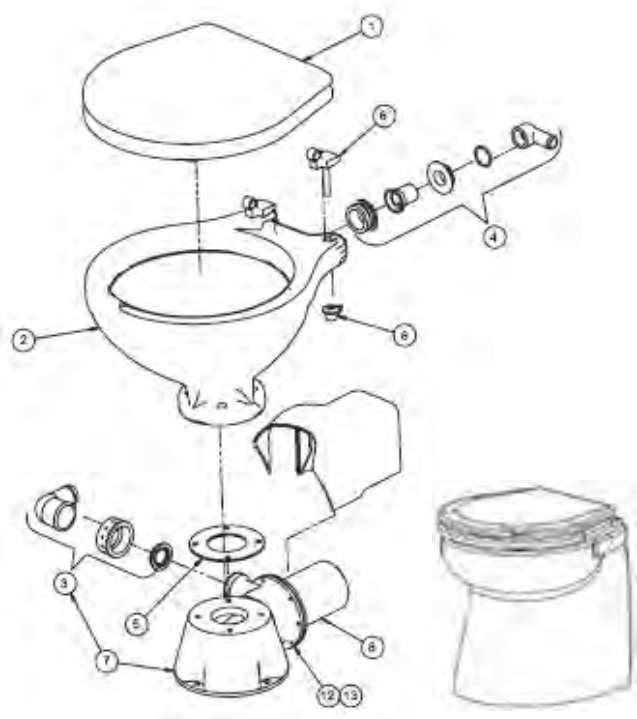

Johnson AquaT Silent-Electric & Silent Premium-Electric Toilet		
Ref.	Description	Item Code
1	Soft-Close Seat+Cover, white, Silent-Electric Compact	66-81-47241-01
	Soft-Close Seat+Cover, white, Silent-Electric Comfort	66-81-47241-02
2	Vitreous China Bowl, Silent-Electric Compact	66-81-47245-01
	Vitreous China Bowl, Silent-Electric Comfort	66-81-47245-02
3	Outlet Kit 90° 1" & 1-1/2" with Check Valve	66-81-47273-01
-	Vitreous China Bowl, Premium Silent, low, straight	66-81-47245-03
-	Vitreous China Bowl, Premium Silent, low, bevelled	66-81-47245-04
-	Vitreous China Bowl, Premium Silent, standard, straight	66-81-47245-05
-	Vitreous China Bowl, Premium Silent, standard, bevelled	66-81-47245-06
4	Inlet Kit 90°	66-81-47246-01
5	Base Gasket Kit	66-81-47274-01
6	Hinge Kit	66-81-47267-01
	Plastic Base Kit	66-81-47247-01
8	Motor Group, 12V	66-81-47248-01
	Motor Group, 24V	66-81-47248-02
9	Flushing Pump 2.4, 12V	66-10-24677-01
	Flushing Pump 2.4, 24V	66-10-24677-02
10	Control Panel, 12 & 24V	66-81-36105-01
	Complete Gasket Kit	66-81-47451-01
11	Conversion Kit, 12V	66-81-47240-01
	Conversion Kit, 24V	66-81-47240-02
12	Mechanical Seal	66-81-47504-01
13	Macerator Kit	66-81-47519
-	Seat+Cover Silent-Electric Compact, plastic "Soft-Close"	259121
-	Seat+Cover Silent-Electric Comfort, plastic "Soft-Close"	259122
-	Seat+Cover Premium Silent-Electric, plastic "Soft-Close"	259123

Silent Premium-Electric Toilet

allpa "Laguna" Standard & Elegant Electric Toilets		
Ref.	Description	Item Code
1, 2	Pump Body, Macerator Impeller	259130
3, 4	Mechanical Seal	
5, 7	Gasket + Screws Kit	
6	Motor, 12V	259138
	Motor 24V	259139
8, 9	Seal, Lip Seal	259135
10, 11	Pump Body, Wear Plate	
12, 13	Flexible Impeller, O-Ring	
14, 15	Pump Cover, Screws	
16,17	Hose, Hose Clamp	259137
18	Hose	(16 t/m 18)
19, 20	Connection 90°, Check Valve	259134
21, 22	Outlet 90° & plastic Ring Nut	(19 t/m 22)
-	Vitreous China Bowl, Laguna	259150
-	Seat+Cover Solid Wood, white, Laguna	259100
-	Seat+Cover Pastic "Soft-Close", Laguna	259121
-	Control Panel	259092
-	Kit 12V Ref. 1-22	259155
-	Kit 24 Ref. 1-22	259156

allpa "Laguna" Hydro-Vacuum Electric Toilet		
Ref.	Description	Item Code
1, 2	Pump Body, Macerator Impeller	259130
3, 4	Mechanical Seal	
5, 7	Gasket + Screws Kit	
6	Motor 12V	259148
	Motor 24V	259149
-	Flushing Pump 12V	259229
-	Flushing Pump 24V	259230
-	Electric Solenoid Valve 12V	259231
-	Electric Solenoid Valve 24V	259232
8, 11	Hoses	259237
9, 10,	Hose Clamps	
12		
13, 14	Connection Straight, Check Valve	259140
15, 16	Outlet 90° & plastic Ring Nut	
-	Vitreous China Bowl, Laguna	259150
-	Seat+Cover Solid Wood, white, Laguna	259100
-	Seat+Cover Pastic "Soft-Close", Laguna	259121
-	Control Panel	259097



Suction / Press Hose with steel spiral inlay. Smooth surface, inside/outside white, not transparent, Impermeable.

**Item Code** 811621 16 x 21mm, 5bar

**Item Code** 811925 19 x 25mm, 5bar

**Item Code** 812534 25 x 32mm, 5bar

**Item Code** 813241 32 x 41mm, 5bar

**Item Code** 813848 38 x 47mm, 4bar

**PVC-Sanitary Hose**



Sanitary Hose "SILVER"

- Sanipomp-Extra
- Maximum Impermeability
- With 5-Year Guarantee
- With vanilla aroma

**Item Code** 891929 Ø19x29mm

**Item Code** 892535 Ø25x35mm

**Item Code** 893848 Ø38x48mm

According to the EUROPEAN, FDA, ISO 9099:2000 TEST METHILIC ALCOOL		
hose type	after 20 month	after 5 years
Sanip,extra	1,8%	4,5%
SBR	31,6%	61,8%
PVC	35,2%	68,9%

**Sanitary Hose "Silver" 5 Year "No-Smell" Guarantee**

OUR SHIELD 5 YEARS WARRANTY BUTYL W

Transparent PVC hose with polyester inlay. Food quality. Temp. range: -20°C to +60°C. Max. bar at +20°C (working pressure)

**Item Code** 800814 8 x 14mm 20bar **Item Code** 802534 25 x 34mm 13bar

**Item Code** 801319 13 x 19mm 15bar **Item Code** 803242 32 x 42mm 10bar

**Item Code** 801521 15 x 21mm 14bar **Item Code** 803848 38 x 48mm 8bar

**Item Code** 801927 19 x 27mm 14bar **Item Code** 805060 50 x 60mm 6bar

**Cold Water Hoses**



Transparent PVC hose with steel spiral inlay Temp. range: -15°C - +65°C. Max. bar at +20°C (working pressure)

**Item Code** 861016 10 x 16mm 7bar **Item Code** 862533 25 x 33mm 5bar

**Item Code** 861319 13 x 19mm 6bar **Item Code** 862836 28 x 36mm 4,5bar

**Item Code** 861623 16 x 23mm 6bar **Item Code** 863241 32 x 41mm 4bar

**Item Code** 862027 20 x 27mm 5bar **Item Code** 863847 38 x 47mm 4bar

**Cold Water Hoses**



### Vented Loops

Item Code 66-81-47237-01	3/4"
Item Code 66-81-47237-02	1"
Item Code 66-81-47237-03	1-1/2"

### Vented Loops

Item Code 66-09-47316-01	12mm
Item Code 66-09-47316-02	16mm
Item Code 66-09-47316-03	19mm
Item Code 66-09-47316-04	22mm
Item Code 66-09-47316-05	25mm
Item Code 66-09-47316-06	Service Kit for Breather Valve

### Y-Valve

Item Code 66-81-47238-01
--------------------------

### Control panel Standard Electric Toilets

Item Code 66-81-47520-01	12V & 24V
--------------------------	-----------

### Control panel Silent & Premium Silent Electric Toilets

Item Code 66-81-36105-01	12V & 24V
--------------------------	-----------

### Conversion Kit Silent Electric

Base+ 90°-elbow+motor+macerator

Item Code 66-81-47240-01	12V
Item Code 66-81-47240-02	24V

### Conversion Kit Standard Electric

Base+motor+ macerator+ control panel

Item Code 66-81-47442-01	12V
Item Code 66-81-47442-02	24V

Item Code 66-81-47247-01	Loose foot
--------------------------	------------

Item Code 66-81-47248-01	Loose motor 12V
--------------------------	-----------------

Item Code 66-81-47248-02	Loose motor 24V
--------------------------	-----------------

### Toilet Flushing Pumps

Item Code 66-10-24677-01	Flush 2.4	12V
--------------------------	-----------	-----

Item Code 66-10-24677-02	Flush 2.4	24V
--------------------------	-----------	-----

### Electric Solenoid Valve

0.35-12bar, normally closed

Item Code 259300	E-Valve 12V/6W, 3/4", flow 18mm
------------------	---------------------------------

Item Code 259301	E-Valve 24V/6W, 3/4", flow 18mm
------------------	---------------------------------

Item Code 259305	Plug
------------------	------

Item Code 259231	E-Valve 12V/6W, 1/2"
------------------	----------------------

Item Code 259232	E-Valve 24V/6W, 1/2"
------------------	----------------------

## Accessories



25/38mm



38mm

38mm





**TA3P10-19 Black water Pump**

Motor Housing: phenol plastic (PF)  
 Impeller 66-09-1052S-9 (nitrile)  
 Impeller Housing: thermoplastic polyester (PET)  
 Stainless Steel Shaft with lip seal  
 Hose Connection "IN" 38mm(1½"), "OUT" 25mm(1")  
 Motor 12V-14A, 24V-7A  
 Dims. 230 x 108 x 82mm(L x w x h)  
 Weight 1,9kg  
 Capacity 23l/min

**ItemCode**  
**66-10-24453-04 12 V**  
**ItemCode**  
**66-10-24453-05 24 V**

**Macerator Pump**



**Item Code 001182**

Complies with ISO Requirements. Chromed Brass, heavy execution. O-ring sealing. Hose Connections: 38-50-60mm. Complete with opening key

**Deck Plate for Waste Water Discharge**



**Item Code 259210**

Plastic Universal Three Way Valve  
 Connections Ø1½" (38mm)  
 Dims. 135 x 110 x 80mm (w x l x h)

**Y-Valve**



For installations below the waterline

**Item Code 259200** ¾" 19mm  
**Item Code 259202** 1" 25mm  
**Item Code 259201** 1½" 38mm

**Breathers**

**Item Code 259251**

With LED Indication for ¾- tank & full, incl. test facility. No moving sensor! For 12 & 24 V. Dims.: 62 x 62mm (HxW) White color. Cut out size 48x29x15mm. Mounting 48x48mm, Ø4,5mm

**Level Indicator for Waste Water Tanks**



**Item Code 184200**

The ideal filter for mounting in breather lines of waste tanks 16 & 19mm connections

**Carbon Filter**



Provided with internal thread connections: 4 x ¾" (½" for 47 & 112 l) , 4 x 1¼" and 1 x 3/8". Wall thickness: 6mm.

**Tanks with space saving sloping side:**

**Item Code 184250** 50l Dims. 430 x 540 x 290mm (w x l x h)  
**Item Code 184275** 75l Dims. 430 x 800 x 290mm (w x l x h)  
**Item Code 184298** 98l Dims. 430 x 1000 x 290mm (w x l x h)

**Blue Waste Tanks of Polyethylene**



**Rectangular Tanks:**

**Item Code 184247** 47l Dims. 480 x 400 x 330mm (L x w x h)  
**Item Code 184278** 78l Dims. 700 x 400 x 300mm (L x w x h)  
**Item Code 184312** 112l Dims. 700 x 800 x 200mm (L x w x h)

All tanks except 112L are provided with recess for pump.

A safe biodegradable non-hazardous Waste tank cleaner. Designed to remove contaminants that limit the operation of the Waste water system and cause foul odors. The solution also cleans and degreases the system. In addition, it is safe for all sanitary systems. 3,8 liter ready-to-use Shields Sanisystem cleaner cleans tanks up to 75 liters.

**Waste tank cleaner**

**Item Code 64189093** Waste tank cleaner - 3,8l

**NEW**



MARINE green.

**A: Polyethylene Waste Tanks**

Wall thickness: 6mm

Polyethylene tanks provided with internal thread connections:

4 x 3/4" (1/2" for 47 & 112 l) , 4 x 1 1/4" and 1 x 3/8".

- Tank beveled 50l 430 x 550 x 290mm (BxLxH)
- Tank beveled 75l 430 x 800 x 290mm (BxLxH)
- Tank beveled 98l 430 x 1050 x 290mm (BxLxH)
- Tank rectangular 47l\* 480 x 400 x 330mm (LxBxH)
- Tank rectangular 78l 700 x 400 x 300mm (LxBxH)
- Tank rectangular 112l\* 700 x 800 x 200mm (LxBxH)

all tanks – except 112l - have a recess formounting the discharge pump.

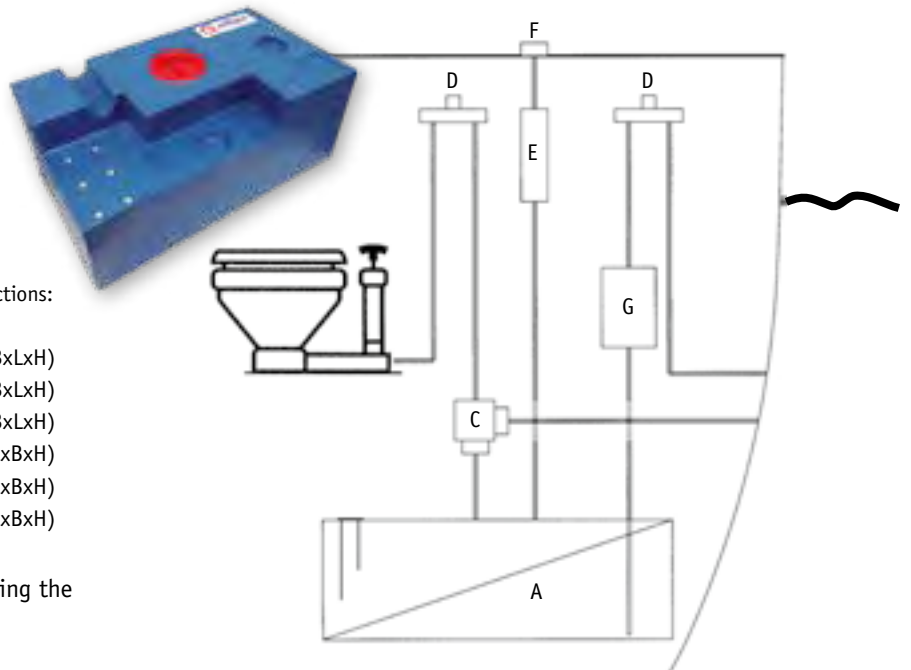

**B: Waste Level Indicator**

3 x LED Indication



Item Code 259251

**C: Y-Valve**

Plastic Universal Three Way Valve Connections Ø1 1/2" (38mm)



Item Code 259210

**D: Breather**

For installation below the waterline 1 1/2" (38mm)



Item Code 259201

**E: Carbon filter**

The ideal filter for mounting in breather lines of waste tanks 16 & 19mm connections



Item Code 184200

**F: Breather Nipple**

Breather Nipple 16mm connection.



Item Code 482050

**G: Macerator Pump**

Black Water Pump Motor 12V-15A 43l/min. 3m total head. Hose Connections: "IN" 38mm (1 1/2"), "OUT" 25mm (1").



Item Code 259113 12V-15A  
Item Code 259114 24V-7.5A  
Item Code 259117 Servicekit



**Complete Waste-Water-Tank-Kits with 12 V macerator pump (24V Pump on request)**

These kits consist of: Polyethylene tank, macerator pump, breather nipple, breather (1x), carbon filter, Y-valve and tank level sender with indicator.

- Item Code 184550** Waste-Water-Tank-Kit, 50l, beveled  
Dims.: 430 x 550 x 290mm (w x l x h)
- Item Code 184575** Waste-Water-Tank-Kit, 75l beveled  
Dims.: 430 x 800 x 290mm (w x l x h)
- Item Code 184598** Waste-Water-Tank-Kit, 98l, beveled  
Dims.: 430 x 1050 x 290mm (w x l x h)
- Item Code 184547** Waste-Water-Tank-Kit, 47l, straight  
Dims.: 480 x 400 x 330mm (w x l x h)
- Item Code 184578** Waste-Water-Tank-Kit, 78l, straight  
Dims.: 700 x 400 x 300mm (w x l x h)
- Item Code 184612\*** Waste-Water-Tank-Kit, 112l, straight  
Dims.: 700 x 800 x 200mm (w x l x h)

Tank wall thickness: 6mm

Note: Please use Loctite 5331 seal glue for plastic-metal joints (-60° to +150°C) when using brass fittings.

\* Cut out for pump not for 112L tank. Pump must be fitted "in line".

	Volume l	Length mm	Height mm	Width mm	Weight kg
<b>Item Code 483163</b>	61	200	950	390	7,5
<b>Item Code 483171</b>	73	290	750	390	5.5

With transparent see-through-cap at 3/4" of full level.  
Incl. 2 x 1 1/2" - 38mm and 1 x 1" - 25mm drain sockets.

- Item Code 483185** Aspiration Pipe, L = 1000mm
- Item Code 483180** Drain Socket 1 1/2" x 38mm

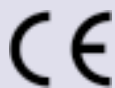

### Polyethylene Waste-Water-Tanks Upright Version



- Item Code 483602** Plastic odor filter with active carbon, for Fuel and Black Water Tanks. With bracket. Hose connection Ø19-25mm D=150mm, H=132mm (204mm incl. hose pillars)  
**Item Code 483604** Replacement Filter Element

### Odor filter for Waste-Water & Fuel Tanks



The Grey water tank is designed to be used as collection tank for waste water from showers, sinks, dishwashing machines, etc with 19mm, 25mm and 38mm inlet ports, and 19mm and 25mm outlet ports. The tank includes an Ultima Switch for automatic operation and is easy to connect to any 12V/24V pump up to 20 amp.

The tank is prepared for Viking Power 16, with pre-drilled holes for the pump. Dims.: 185 x 280 x 340mm  
Dimensions: 185x280x340mm.

**Item Code 66-09-13384**

Grey Water Tank (Viking power 16 Pump not included)

### Grey Water Tank

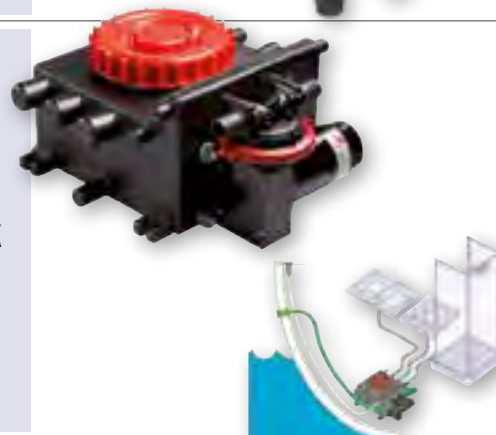

- Code 184747** Waste Water Tank Kit 47L, 480x400x330mm (lxbxh), 12V
- Code 184778** Waste Water Tank Kit 78L, 700x400x300mm (lxbxh), 12V
- Code 184847** Waste Water Tank Kit 47L, 480x400x330mm (lxbxh), 24V
- Code 184878** Waste Water Tank Kit 78L, 700x400x300mm (lxbxh), 24V

New developed kits with pre-mounted diaphragm pump. Due to a new suction method the remaining faeces are reduced to a minimum. These kits consists of the following 7 parts: Waste tank, breather nipple, breather, diaphragm pump, carbon filter, Y-way valve, waste level indicator with sender and straight hose connector 1-1/4" x Ø38 (**Item Code 259261**). Possible 90° hose connector: **Item Code 1004F38+000092F**.

### Waste-Water-Tank-Kits with Diaphragm Pump

Spare pump  
12V **Code 183212**  
24V **Code 183224**



	Volume l	Length mm	Width mm	Weight kg	Shape
<b>Item Code 483190</b>	60	730	730	0.8	■
<b>Item Code 483191</b>	120	730	1030	1.65	■
<b>Item Code 483192</b>	55	950	950	0.75	▲
<b>Item Code 483193</b>	100	1100	1100	1.30	▲

### Flexible Waste-Water-Tanks Incl. Nipples

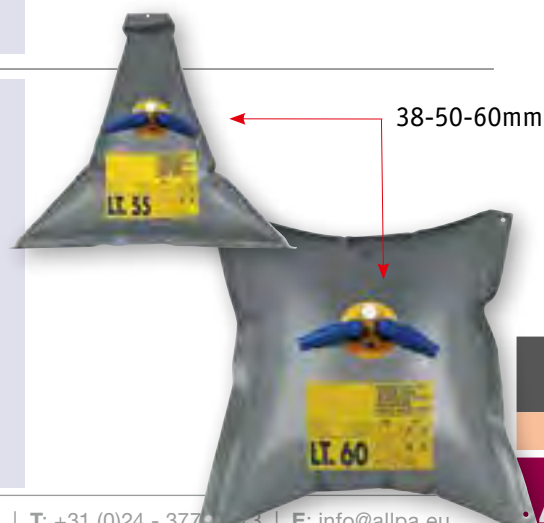



**Brass Skin Fittings**

Item C. 001123B15	3/8" x 15mm	Item C. 001123J57	2" x 57mm
Item C. 001123C18	1/2" x 18mm	Item C. 001123K70	2 1/2" x 72mm
Item C. 001123D24	3/4" x 24mm	Item C. 001123L80	3" x 80mm
Item C. 001123E30	1" x 30mm		
Item C. 001123F40	1 1/4" x 40mm		
Item C. 001123G45	1 1/2" x 45mm		



**Brass Skin Fittings**

Item Code 001121B	3/8"	Item Code 001121F	1 1/4"
Item Code 001121C	1/2"	Item Code 001121G	1 1/2"
Item Code 001121D	3/4"	Item Code 001121J	2"
Item Code 001121E	1"	Item Code 001121K	2 1/2"
		Item Code 001121L	3"



**Brass grated Water Intakes**

Item Code 001120B	3/8"	Item Code 001120F	1 1/4"
Item Code 001120C	1/2"	Item Code 001120G	1 1/2"
Item Code 001120D	3/4"	Item Code 001120J	2"
Item Code 001120E	1"		



**Brass Hose Nipples**

Item Code 1004A6	1/4" x6mm	Item Code 1004E30	1" x30mm
Item Code 1004A8	1/4" x8mm	Item Code 1004E32	1" x32mm
Item Code 1004A10	1/4" x10mm	Item Code 1004F32	1 1/4" x32mm
Item Code 1004B10	3/8" x10mm	Item Code 1004F38	1 1/4" x38mm
Item Code 1004B13	3/8" x13mm	Item Code 1004F40	1 1/4" x40mm
Item Code 1004B15	3/8" x15mm	Item Code 1004G38	1 1/2" x38mm
Item Code 1004C14	1/2" x14mm	Item Code 1004G40	1 1/2" x40mm
Item Code 1004C16	1/2" x16mm	Item Code 1004G45	1 1/2" x45mm
Item Code 1004C20	1/2" x20mm	Item Code 1004G50	1 1/2" x50mm
Item Code 1004D13	3/4" x13mm	Item Code 1004J50	2" x 50mm
Item Code 1004D16	3/4" x16mm	Item Code 1004J60	2" x60mm
Item Code 1004D20	3/4" x20mm	Item Code 1004K70	2 1/2" x70mm
Item Code 1004D25	3/4" x25mm	Item Code 1004L80	3" x80mm
Item Code 1004E25	1" x25mm		



**Brass Straight Coupling Female**

Item Code 000270-	1/8"	Item Code 000270E	1"
Item Code 000270A	1/4"	Item Code 000270F	1 1/4"
Item Code 000270B	3/8"	Item Code 000270G	1 1/2"
Item Code 000270C	1/2"	Item Code 000270J	2"
Item Code 000270D	3/4"		



**Brass T-Fittings With internal thread**

Item Code 000130-	1/8"	Item Code 000130E	1"
Item Code 000130A	1/4"	Item Code 000130F	1 1/4"
Item Code 000130B	3/8"	Item Code 000130G	1 1/2"
Item Code 000130C	1/2"	Item Code 000130J	2"
Item Code 000130D	3/4"		



**Brass 90° Elbow Male/Female**

Item Code 000092-	1/8"	Item Code 000092E	1"
Item Code 000092A	1/4"	Item Code 000092F	1 1/4"
Item Code 000092B	3/8"	Item Code 000092G	1 1/2"
Item Code 000092C	1/2"	Item Code 000092J	2"
Item Code 000092D	3/4"		

Item C. 001540A	1/4"	Item C. 001540B	3/8"
Item C. 001540C	1/2"	Item C. 001540D	3/4"
Item C. 001540E	1"	Item C. 001540F	1 1/4"
Item C. 001540G	1 1/2"	Item C. 001540J	2"
Item C. 001540K	2 1/2"		

**Full Flow Ball Valves  
Nickel-Plated Brass**



Item C. 001551A	1/4"	Item C. 001551E	1"
Item C. 001551B	3/8"	Item C. 001551F	1 1/4"
Item C. 001551C	1/2"	Item C. 001551G	1 1/2"
Item C. 001551D	3/4"	Item C. 001551J	2"

**3-Way Ball Valve**

"T-Flow" Nickel Plated Brass



Item Code 001585CBB	1/2" x 3/8" x 3/8"
Item Code 001585DCC	3/4" x 1/2" x 1/2"
Item Code 001585EDD	1" x 3/4" x 3/4"
Item Code 001585FEE	1 1/4" x 1" x 1"

**Ball Valve with Double  
Outlet Nickel Plated Brass**



Stainless Steel Ball Valves with full Flow. Suitable as shut-off valve for fuel systems.

Item Code 001815A	1/4"
Item Code 001815B	3/8"
Item Code 001815C	1/2"
Item Code 001815G	1 1/2"

**Stainless Steel  
Ball Valves**



Item Code 001134A	1/4" with hose pillar 12mm, with handle
Item Code 001135A	1/4" with hose pillar 17mm, with slot for screwdriver
Item Code 001596C	1/2" inner-/outer thread

**Brass Ball Drain  
Cocks Male/Female**



**Features**

- Mounts in any position
- Flow direction both ways
- Bronze body, CC491K (UNI EN 1982)
- Neoprene seals
- ABS Operating knob, fire-resistant
- Full flow

**Safety Intake  
NON-STICK VALVE  
Bronze**



Dims:	Item Code 002260B	Item Code 002260C	Item Code 002260D	Item Code 002260E	Item Code 002260F	Item Code 002260G	Item Code 002260J
SW	25mm	25mm	31mm	38mm	47mm	54mm	67mm
V	53mm	53mm	58mm	63mm	72mm	78mm	90mm
H	76mm	76mm	85mm	94mm	110mm	118mm	139mm
L	67mm	67mm	73mm	84mm	97mm	103mm	124mm
F	15mm	15mm	20mm	25mm	33mm	38mm	48mm
A	11,4mm	15mm	16,3mm	19,1mm	21,4mm	21,4mm	25,7mm
G	3/8"	1/2"	3/4"	1"	1"-1/4	1"-1/2	2"

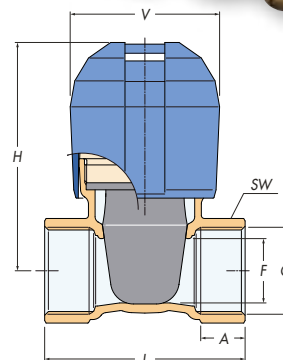



**Brass Male Nipples**

Item Code 000280-	1/8"	Item Code 000280E	1"
Item Code 000280A	1/4"	Item Code 000280F	1-1/4"
Item Code 000280B	3/8"	Item Code 000280G	1-1/2"
Item Code 000280C	1/2"	Item Code 000280J	2"
Item Code 000280D	3/4"		

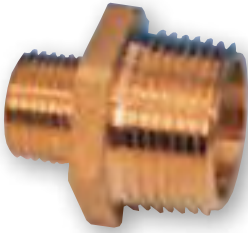

**Brass Reducing Nipples Male**

Item Code 000245A-	1/4"	x	1/8"
Item Code 000245CB	1/2"	x	3/8"
Item Code 000245BA	3/8"	x	1/4"
Item Code 000245DC	3/4"	x	1/2"
Item Code 000245ED	1"	x	3/4"
Item Code 000245FE	1 1/4"	x	1
Item Code 000245GF	1 1/2"	x	1 1/4"
Item Code 000245JG	2"	x	1 1/2"
Item Code 000245KJ	2 1/2"	x	2"



**Brass Straight Reducer Male/Female**

Code 000241A-	1/4"	x	1/8"	Code 000241ED	1"	x	3/4"
Code 000241B-	3/8"	x	1/8"	Code 000241FD	1 1/4"	x	3/4"
Code 000241BA	3/8"	x	1/4"	Code 000241FE	1 1/4"	x	1"
Code 000241CA	1/2"	x	1/4"	Code 000241GD	1 1/2"	x	3/4"
Code 000241CB	1/2"	x	3/8"	Code 000241GE	1 1/2"	x	1"
Code 000241DA	3/4"	x	1/4"	Code 000241GF	1 1/2"	x	1 1/4"
Code 000241DB	3/4"	x	3/8"	Code 000241JG	2"	x	1 1/2"
Code 000241DC	3/4"	x	1/2"				
Code 000241EB	1"	x	3/8"				
Code 000241EC	1"	x	1/2"				



**Brass Barrel Nipples**

Item Code 000530B-80	3/8"	x	80mm
Item Code 000530C-100	1/2"	x	100mm
Item Code 000530D-120	3/4"	x	120mm
Item Code 000530E-150	1"	x	150mm



**Brass Male Plugs**

Item Code 000290-	1/8"	Item Code 000290E	1"
Item Code 000290A	1/4"	Item Code 000290F	1 1/4"
Item Code 000290B	3/8"	Item Code 000290G	1 1/2"
Item Code 000290C	1/2"	Item Code 000290J	2"
Item Code 000290D	3/4"		



**Brass Bends Female/Female**

Brass bend 90° inner thread	Brass bend 45° inner thread		
Item Code 001002F	1 1/4"	Item Code 000120G	1 1/2"
Item Code 001002G	1 1/2"	Item Code 000120J	2"
Item Code 001002J	2"		



**Brass Manifolds**

Item Code 001007DB-2	2-weg	3/4"	x	1/2"
Item Code 001007DB-3	3-weg	3/4"	x	1/2"
Item Code 001007DB-4	4-weg	3/4"	x	1/2"
Item Code 001007EC-2	2-weg	1"	x	1/2"
Item Code 001007EC-3	3-weg	1"	x	1/2"
Item Code 001007EC-4	4-weg	1"	x	1/2"

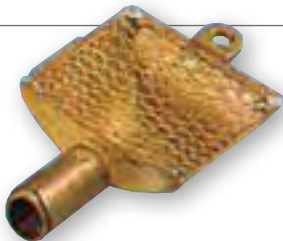

**Brass Bilge Pump Filter with stainless steel gauze**

With stainless steel gauze	
Item Code 001200	Ø20mm
Item Code 001201	Ø25mm



**Stainless Steel Filter/  
Brass Spring Check Valve**

Filter	Check valve		
Item Code 001533/C-B	3/8"	Item Code 001532B	3/8"
Item Code 001533/C-C	1/2"	Item Code 001532C	1/2"
Item Code 001533/C-D	3/4"	Item Code 001532D	3/4"
Item Code 001533/C-E	1"	Item Code 001532E	1"

	Hose (A)	B mm	C mm	D mm
Item Code 072695	10mm 3/8"	52	35	21
Item Code 072696	13mm 1/2"	52	35	26
Item Code 072697	19mm 3/4"	59	39	26
Item Code 072698	26mm 1"	68	49	40
Item Code 072699	32mm 1-1/4"	72	55	41
Item Code 072700	38mm 1-1/2"	77	64	43
Item Code 072701	52mm 2"			

### Stainless Steel Skin Fittings



### Item Code 078690

With removable cover (key supplied)  
The integrated ball prevents water from flowing back  
A = 38mm, B = 58mm, C = 115mm, D = 91mm

### Plastic Discharge Elbow with S/S Cover



Item Code	Amm	Bmm	Cmm	Dmm
078685	16	15	36	42
078686	19	15	36	42
078687	25	15	36	42
078688	38	33	63	90 (Plastic elbow)

### Stainless Steel Discharge



Plastic Skin Fittings with Hose Connector

	A	B	C	D	E	
	mm	mm	mm	mm	mm	
Item Code 062039	5/8"	22	15	75	43	39
Item Code 062040	3/4"	25	18	83	51	43
Item Code 062041	1"	32	25	94	62	45
Item Code 062043	1 1/4"	46	30	95	76	55
Item Code 062042	1 1/2"	46	40	104	78	54

### Skin Fittings

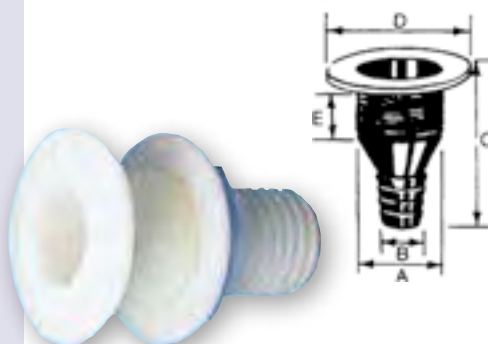

Brass, chromed

Item Code 001191C	1/2"
Item Code 001191E	1

### Breather Nipples

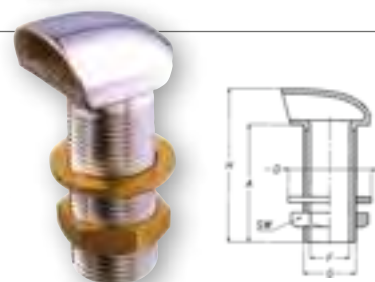

Nickel Plated Brass

Item Code 001250	1/2"
------------------	------

with lock ball

### Siphon Break Valve

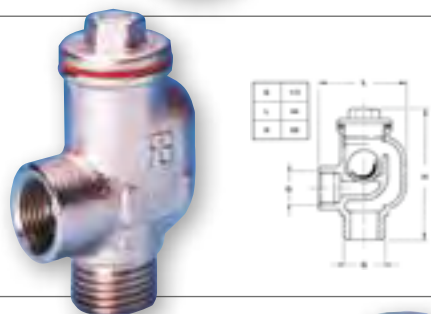

chromed brass

Item Code 001191	Ø16mm, straight
Item Code 001190	Ø20mm, straight
Item Code 001188/S	Ø16mm, 90°
Item Code 482050	Ø16mm, straight
Item Code 482052	Ø19mm, straight

### Breather Nipples

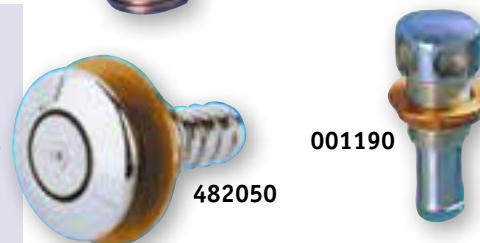



**Plastic Skin Fittings**

**Sturdy plastic skin fittings with straight connector and stainless steel (316) flange**

<b>Item Code 078920</b>	Hose connection 13mm (1/2"), L= 81mm, flange Ø48mm
<b>Item Code 078921</b>	Hose connection 16mm (5/8"), L= 81mm, flange Ø48mm
<b>Item Code 078922</b>	Hose connection 19mm (3/4"), L= 86mm, flange Ø48mm
<b>Item Code 078923</b>	Hose connection 26mm (1"), L= 86mm, flange Ø48mm
<b>Item Code 078924</b>	Hose connection 29mm (1-1/8"), L= 87mm, flange Ø48mm
<b>Item Code 078925</b>	Hose connection 32mm (1 1/4"), L= 103mm, flange Ø60mm
<b>Item Code 078926</b>	Hose connection 38mm (1 1/2"), L= 103mm, flange Ø60mm
<b>Item Code 078927</b>	Hose connection 52mm (2"), L= 130mm, flange Ø82mm



**Plastic Skin Fittings 90° Bend**

**Sturdy plastic skin fittings with 90° bend and stainless steel (316) flange**

<b>Item Code 078930</b>	Hose connection 16mm (5/8"), L= 63mm, flange Ø48mm
<b>Item Code 078931</b>	Hose connection 19mm (3/4"), L= 81mm, flange Ø48mm
<b>Item Code 078932</b>	Hose connection 26mm (1"), L= 95mm, flange Ø48mm
<b>Item Code 078933</b>	Hose connection 29mm (1-1/8"), L= 95mm, flange Ø48mm
<b>Item Code 078934</b>	Hose connection 38mm (1 1/2"), L= 112mm, flange Ø60mm
<b>Item Code 078935</b>	Hose connection 52mm (2"), L= 115mm, flange Ø82mm



**Plastic Skin Fittings 90° Bend**

**Plastic Skin Fittings 90° Bend**

<b>Item Code 483176</b>	3/4" x 19mm
<b>Item Code 483177</b>	1" x 25mm
<b>Item Code 483178</b>	1-1/2" x 38mm



**Plastic Straight Female Couplings**

**Plastic straight female couplings reinforced with stainless steel (316) ring**

<b>Item Code 486900</b>	1/2 x 1/2
<b>Item Code 486901</b>	3/4 x 3/4
<b>Item Code 486902</b>	1 x 1
<b>Item Code 486903</b>	1 1/4 x 1 1/4
<b>Item Code 486904</b>	1 1/2 x 1 1/2



**Black plastic ball valves with internal thread (PA-6 nylon)**

Item Code 486600	1/2"
Item Code 486601	3/4"
Item Code 486602	1"
Item Code 486603	1 1/4"
Item Code 486604	1 1/2"
Item Code 486605	2"

Connectors  
for water tanks



**White plastic skin fittings with outer thread**

Item Code 486610	1/2"
Item Code 486611	3/4"
Item Code 486612	1"
Item Code 486613	1 1/4"
Item Code 486614	1 1/2"
Item Code 486615	2"

Connectors  
for water tanks



**Black plastic hose nipples with outer thread**

Straight		90° Bend	
Item C. 486620	1/2" x 13mm	Item C. 486630	1/2" x 13mm
Item C. 486621	3/4" x 19mm	Item C. 486631	3/4" x 19mm
Item C. 486622	1" x 25mm	Item C. 486632	1" x 25mm
Item C. 486623	1 1/4" x 32mm	Item C. 486633	1 1/4" x 32mm
Item C. 486624	1 1/2" x 32mm	Item C. 486634	1 1/2" x 38mm
Item C. 486625	1 1/2" x 38mm	Item C. 486635	2" x 50mm

Connectors  
for water tanks



**White plastic reducer hose connections**

Item Code 486640	19 x 13mm
Item Code 486641	19 x 16mm
Item Code 486642	25 x 19mm
Item Code 486643	32 x 25mm
Item Code 486644	38 x 25mm
Item Code 486645	38 x 32mm

Connectors  
for water tanks



**White plastic Y-hose connectors**

Item Code 486650	25 x 25 x 38mm
Item Code 486651	25 x 25 x 25mm
Item Code 486652	38 x 38 x 38mm

Connectors  
for water tanks





**Fuel Hoses**  
suitable for oil,  
petrol & diesel  
with approval

**SAE J1527 B2 and ISO 8469 TYPE B Class Standard**

**Item Code 002000** 8 x 13mm Grey, 25 Meters

Temperature range: -30°C to + 80°C



**Exhaust Hose**  
with Lloyd's  
Approval

Very flexible exhaust hose with steel spiral inlay. Temperature range: -25°C + 120°C. Black with green tape print: "Marine Wet Exhaust - Approved Lloyd's Register no. 96/00127 (E3) & 96/00126 (E3)"

<b>Item Code 800040</b>	40 x 50mm
<b>Item Code 800045</b>	45 x 55mm
<b>Item Code 800050</b>	50 x 62mm
<b>Item Code 800060</b>	60 x 70mm
<b>Item Code 800152</b>	152 x 164mm
<b>Item Code 800075</b>	76 x 86mm
<b>Item Code 800090</b>	90 x 100mm
<b>Item Code 800100</b>	102 x 113mm
<b>Item Code 800127</b>	127 x 137mm



**Diesel & Petrol**  
Resistant Rubber  
Hose

Suitable for diesel, bio-diesel and unleaded fuel.

Standards: • SAE J 1527 • USCG A1 R1  
• ISO 7840 A1 CE

Approved: • CE • CE 0474 RINA  
• LLOYD'S REGISTER

• Colour: Black with print  
• Temperature range: -30°C to + 100°C

<b>Item Code 002012</b>	6 x 16mm – max 14 bar
<b>Item Code 002013</b>	8 x 17mm – max 14 bar
<b>Item Code 002060</b>	10 x 19mm – max 14 bar
<b>Item Code 002062</b>	12.5 x 22mm – max 12 bar
<b>Item Code 002014</b>	16 x 26mm – max 10 bar



**Diesel & Petrol**  
Resistant Rubber  
Hose

Inner Material: Nitrile, Outside: Neoprene

• Colour: Black with print  
• Working Pressure: 10bar  
• Burst Pressure: 30bar  
• Static wire R<1W  
• Temp. range: -30°C to + 80°C

<b>Item Code 831927</b>	19 x 27mm
<b>Item Code 831017</b>	10 x 17mm
<b>Item Code 831322</b>	13 x 22mm
<b>Item Code 831623</b>	16 x 23mm



**Diesel & Petrol**  
Resistant Rubber  
Hose with Steel  
Spiral Inlay

Suitable for diesel, bio-diesel and unleaded fuel.

Standards: • SAE J 1527 • USCG A1 R2  
• ISO 7840 A1 CE

Approved: • CE • CE 0474 RINA • LLOYD'S REGISTER

• Colour: black with red label with Print  
• Temp. range: -30°C to + 100°C

<b>Item Code 852532</b>	25 x 32mm – max 10 bar
<b>Item Code 853245</b>	32 x 44mm – max 10 bar, with steel spiral inlay
<b>Item Code 853852</b>	38 x 51mm – max 10 bar, with steel spiral inlay
<b>Item Code 855065</b>	51 x 64mm – max 10 bar, with steel spiral inlay

Transparent PVC hose with polyester inlay  
Food Quality

Temp. -20°C - +60°C Max. bar at +20°C (working pressure):

<b>Item Code 800814</b>	8 x 14mm	20 bar
<b>Item Code 801319</b>	19 x 13mm	15 bar
<b>Item Code 801521</b>	21 x 15mm	14 bar
<b>Item Code 801927</b>	27 x 19mm	14 bar
<b>Item Code 802534</b>	34 x 25mm	13 bar
<b>Item Code 803242</b>	42 x 32mm	10 bar
<b>Item Code 803848</b>	48 x 38mm	8 bar
<b>Item Code 805060</b>	60 x 50mm	6 bar

### Cold Water Hose



European

Transparent PVC hose with steel spiral inlay

Temp. -15°C - +65°C

Max. bar at +20°C (working pressure):

<b>Item Code 861016</b>	10 x 16mm	7 bar
<b>Item Code 861319</b>	13 x 19mm	6 bar
<b>Item Code 861623</b>	16 x 23mm	6 bar
<b>Item Code 862027</b>	20 x 27mm	5 bar
<b>Item Code 862533</b>	25 x 33mm	5 bar
<b>Item Code 862836</b>	28 x 36mm	4,5 bar
<b>Item Code 863241</b>	32 x 41mm	4 bar
<b>Item Code 863847</b>	38 x 47mm	4 bar

### Cold Water Hose



ributo

Hot Water Hose (EPDM) for allpa Boilers

- Colour: black with red striping
- Working pressure: 15bar
- Burst pressure: 45bar
- Temp. range: -35°C - +115°C
- Also suitable for cooling water (cooling liquid)

<b>Item Code 841319</b>	13 x 19mm
<b>Item Code 841522</b>	16 x 23mm
<b>Item Code 841927</b>	19 x 27mm

### Hot Water Hose



Most flexible, pressure-resistant and anti-torsion PVC hose.

- Color: white and blue core.
- Working pressure: 8 bar
- Temp. -10°C +60°C

<b>Item Code 881317</b>	13 x 17mm	8bar	65mm Bending Radius
<b>Item Code 881621</b>	16 x 21mm	8bar	75mm Bending Radius
<b>Item Code 881925</b>	19 x 25mm	8bar	75mm Bending Radius

### Deck Wash Hose



- Color: int. white, food quality. Ext. blue with print
- Working pressure: 7bar
- Temp. +120°C

<b>Item Code 821323</b>	13x22mm
<b>Item Code 087123</b>	16x26mm
<b>Item Code 821933</b>	19x33mm

### Steam / Hot Water Hose (EPDM) Food Quality

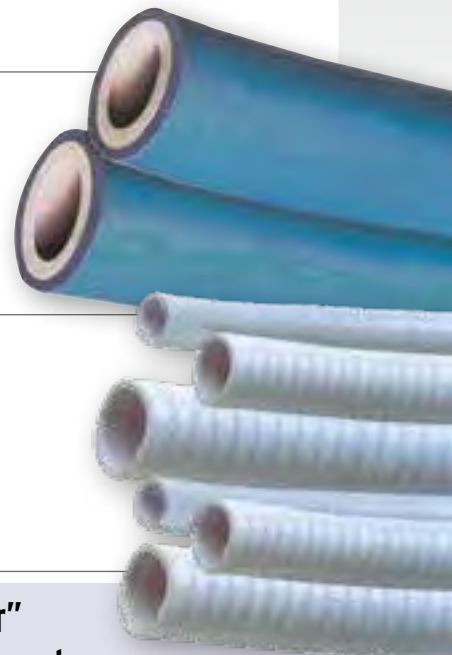

Suction / Press Hose with steel spiral inlay. Smooth surface, inside/outside white, not transparent, Impermeable.

<b>Item Code 811621</b>	16 x 21mm, 5bar
<b>Item Code 811925</b>	19 x 25mm, 5bar
<b>Item Code 812534</b>	25 x 32mm, 5bar
<b>Item Code 813241</b>	32 x 41mm, 5bar
<b>Item Code 813848</b>	38 x 47mm, 4bar

### PVC-Sanitary Hose

Sanitary Hose "SILVER"

- Sanipomp-Extra
- Maximum Impermeability
- With 5-Year Guarantee
- With vanilla aroma

<b>Code 891929</b>	Ø19 x 29mm
<b>Code 892535</b>	Ø25 x 35mm
<b>Code 893848</b>	Ø38 x 48mm

According to the EUROPEAN . FDA. ISO 9099:2000 TEST METHILIC ALCOOL		
hose type	after 20 month	after 5 years
Sanipomp-Extra	1,8%	4,8%
SBR	31,6%	61,5%
PVC	35,2%	68,9%

Sanitary Hose "Silver"  
5 Year "No-Smell" Guarantee



For hose clamps please see page 585



**Making a Connection:**

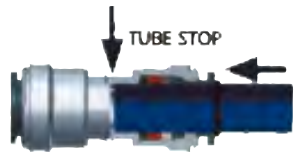

**Item Code 037115**  
Connector Female  
15mm



**Item Code 037120**  
Connector Female  
15mm, 1/2" NPT

**Item Code 037121**  
Connector Female  
15mm, 3/4" NPT

**SeaTech**

Create with a few "clicks" a complete cold- and hot water tubing system in your boat with zero leak connections! The SeaTech System is very easy to install, re-install and change.

The polyethylene metric tube can easily be cut to measure and with the several different fittings one can install the required system in no-time.

All SeaTech connectors incorporate an exclusive O-ring Guide for improved reliability. This unique feature insures zero-leak connections by:

- Protecting the O-ring from damage during connection
- Increasing the connectors side load capacity
- Correctly aligning the tubing with the O-ring every time
- Prevents the O-ring from becoming dislodged

**Technical Information** (pressure and temperature):

Max. working pressure	100 psi	180° F (max. temp)
	6.8 bar	82° C (max. temp)



Highest Flow!



Rotates under pressure!



**SeaTech tube 15mm:**

**Item Code 037100** Cold Water Tube,  
Coil 50' (ca. 16m), Colour Blue

**Item Code 037101** Cold Water Tube,  
Coil 250' (ca. 78m), Colour Blue

**Item Code 037105** Hot Water Tube,  
Coil 50' (ca. 16m), Colour Red

**Item Code 037106** Hot Water Tube,  
Coil 250' (ca. 78m), Colour Red

Connect to Multiple Materials!



Create Mini-Manifolds

Tube Cutter  
**Item Code 037195**



**Item Code 037145**  
Connector male, 15  
mm, 1/2" NPT Thread



**Item Code 037110**  
Union Tee, 15mm

**Item Code 037125**

Union Elbow 15mm

**Item Code 037130**

Male Elbow  
15mm, 1/2" NPT

**Item Code 037135** Female Swivel Elbow, 15mm, 1/2" NPS

**Item Code 037136** Female Swivel Elbow, 15mm, 3/4" NPS

**Item Code 037140**

Stackable Elbow 15mm

**Item Code 037155**

Elbow Pump Connector 15mm

**Item Code 037150**

Union Pump Connector 15mm

**Item Code 037175**

End Stop 15mm

**Item Code 037160**

Stackable Tee 15mm

**Item Code 037170**

Elbow Tube Clip 15mm

**Item Code 037165**

Pipe Clip 15mm

**Item Code 037185**

Shut-Off Valve 15mm

**Item Code 037180** Electric Valve 12V DC, 15mm

**Item Code 037181** Electric Valve 24V DC, 15mm

**Item Code 037190**

Flush Mounted Speed- Tap  
15mm with automatic shut-off valve  
Incl. adapter for standard "Gardena"-connection

**Item Code 037191** Spare adapter

SeaTech



037190

037191



Tank gauge:	Premier Pro	Lido Pro	Argent Pro
Fuel (SW)	84150FE	59655F	65524SSF
Fuel (VDO)	84151FE	65240F	67582SSF
Water (SW)	70605FE	70606FE	67579SSF
Water (VDO)	84160FE	66412F	67581SSF
Black water (VDO)	84161FE	66413F	



### Fuel Tank Sender with Gauge

**CODE F**

Fuel Gauge Sender (240-33 Ohm).  
5-Hole standard mounting pattern, arm right or left adjustable. Suitable for tanks with 4-24" (10-61 cm) depth.  
New „VITON" flange seal: suitable for all fuel types, worldwide.

<b>Item Code 90424K</b>	Fuel Gauge Sender
<b>Item Code 57902E</b>	Fuel Gauge



### Stainless Steel Tank Senders

Fuel and drinkwater tank senders are made of stainless steel and have a plastic float for fuel and drinking water. Waste tank senders are also made of stainless steel but have a stainless steel float of a specific, self-cleaning design.  
USA-type for Teleflex-, Vetus, Faria instruments have suffix "T".  
VDO-type senders have suffix "V". Suitable for 12 & 24V.  
Standard 5-hole mounting pattern (Ø54/70mm).

Length	Fuel senders		Drinking water and grey/black water senders:	
	USA	VDO	USA	VDO
	240-30 Ω	10-180 Ω	240-30 Ω	10-180 Ω
160mm	021810/T	021810/V		
200mm	021811/T	021811/V	021811/WT	021811/WV
250mm	021812/T	021812/V		
280mm	021813/T	021813/V		
300mm	021814/T	021814/V	021814/WT	021814/WV
320mm	021815/T	021815/V		
350mm	021816/T	021816/V		
380mm	021817/T	021817/V		
400mm	021818/T	021818/V	021818/WT	021818/WV
450mm	021819/T	021819/V		
480mm	021820/T	021820/V		
500mm	021821/T	021821/V		



### Mechanical Tank Senders

<b>Item Code 008251</b>	Tank depth 200mm (for tanks 008033/43/53)
<b>Item Code 008253</b>	Tank depth 280mm (for tanks 000042/55/70)
<b>Item Code 008254</b>	Tank depth 490mm (for tanks 008080/110)

Deck fillers with color-coded international symbols with engraved lettering. Straight model with Ø38 mm hose connection. Build in depth is 90mm.

**Item Code 269030 Diesel with venting,**  
Ø38mm hose connection and engraved text in the stainless steel mounting rings

**Item Code 269031 Water with venting,**  
Ø38mm hose connection and engraved text in the stainless steel mounting rings

### Stainless Steel A316 Deck Entries



Deck fillers with color-coded international symbols with engraved lettering and separate key. Straight and 30° angled models with Ø38mm hose connection. Depth is 76mm.

0° Models		30° Models	
ØFlange 76mm		ØFlange 90mm	
<b>Item Code 078221</b>	<b>Water</b>	<b>Item Code 078715</b>	<b>Water</b>
<b>Item Code 078218</b>	<b>Waste</b>	<b>Item Code 078716</b>	<b>Waste</b>
<b>Item Code 078219</b>	<b>Gas</b>	<b>Item Code 078717</b>	<b>Gas</b>
<b>Item Code 078222</b>	<b>Diesel</b>	<b>Item Code 078713</b>	<b>Diesel</b>
<b>Item Code 078220</b>	<b>Fuel</b>	<b>Item Code 078718</b>	<b>Fuel</b>
<b>Item Code 078223</b>	<b>Oil</b>	<b>Item Code 078714</b>	<b>Oil</b>
<b>Item Code 078224</b>	<b>Petrol</b>	<b>Item Code 078719</b>	<b>Petrol</b>
<b>Item Code 078225</b>	Spare key HTH 30mm		
<b>Item Code 078227</b>	Spare Cap (1-1/4")		

### Stainless Steel A316 Deck Entries



**Stainless Steel Deck Entries** Housing out of plastic, the filler cap is Stainless Steel. (A)

<b>Item Code 482043</b>	<b>Fuel</b>	Ø38mm
<b>Item Code 482044</b>	<b>Fuel</b>	Ø50mm
<b>Item Code 482045</b>	<b>Water</b>	Ø38mm

**Plastic Deck Entries** Housing out of plastic with chrome plated lid. (B)

<b>Item Code 482046</b>	<b>Fuel</b>	Ø38mm
<b>Item Code 482047</b>	<b>Fuel</b>	Ø50mm
<b>Item Code 482048</b>	<b>Water</b>	Ø38mm

### Deck Entries

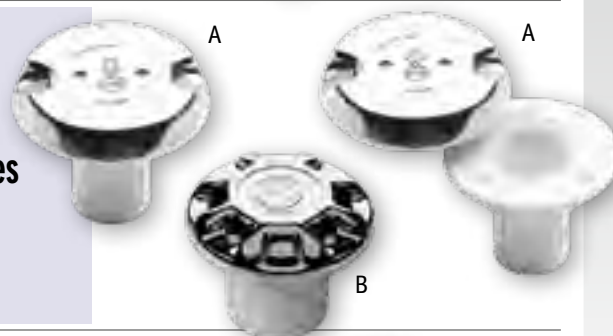

Deck Fillers with separate key  
Inner Thread 1-1/2". Flange Ø83mm. H=48mm,  
Cut-out size Ø54mm

**Item Code 001173 "Fuel"**  
**Item Code 001175 "Aqua"**

**Item Code 001174** Single key HTH 25mm

### Chromed Brass Deck Entries



Deck fillers with folding key  
Flange Ø89mm. H=81mm, Cut-out size Ø50mm

**Item Code 482040 "Diesel",** Ø50mm  
**Item Code 482041 "Water",** Ø35mm  
**Item Code 482042 "Fuel",** Ø50mm

### Chromed Brass Deck Entries



4 Pcs different Color Keys are included:  
Red/Gas, Green/Diesel, Blue/Water, Black/Waste  
6 Pcs Name Plates are included:  
Diesel, Fuel, Gas, Petrol, Waste, Water

**Item Code N2940006** Ø38mm  
**Item Code N2940007** Ø51mm

### Nylon Deck Entries with Color-Coded keys



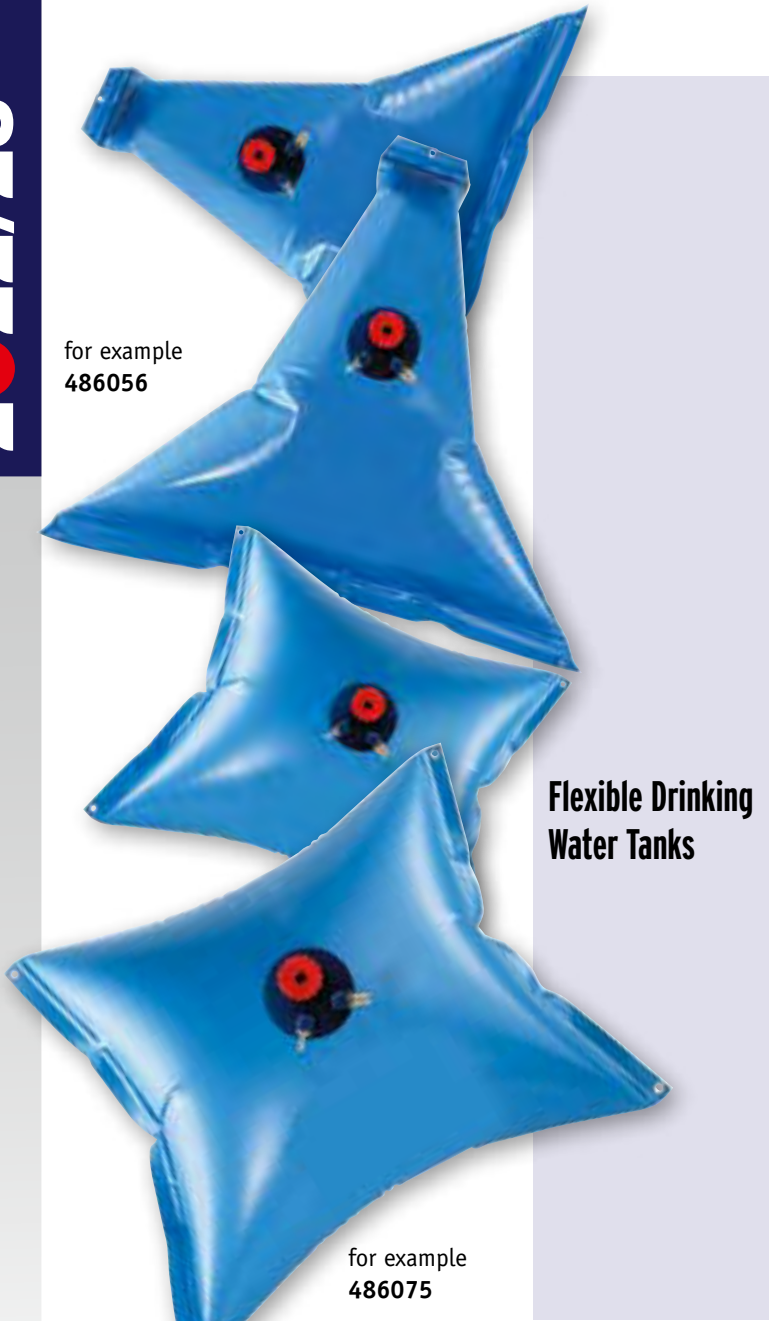

for example  
486056

### Flexible Drinking Water Tanks

for example  
486075

#### Flexible Drinking Water Tanks made of Multilayer Thermoplastic Elastomer

Now supplied with plastic hose connectors:  
1 upright connector adapting Ø10 & 12mm &  
1 upright connector adapting Ø17 & 19mm.

#### Triangular Models:

Item Code 486056	55l	950 x 950mm
Item Code 486100	100l	1100 x 1100mm

#### Rectangular Models:

Item Code 485060	60l	730 x 730mm
Item Code 485075	75l	730 x 800mm
Item Code 485100	100l	730 x 880mm
Item Code 485120	120l	730 x 1030mm
Item Code 485150	150l	730 x 1130mm



### Plastic Fittings

Item Code 482020	3/4" ball valve
Item Code 482021	3/4" x 12mm, straight
Item Code 482022	3/8" x 12mm, 90° bend
Item Code 482016	3/8" x 16-18mm, straight
Item Code 482019	3/8" x 10-12mm, straight
Item Code 482023	3/4" Outlet skin fitting



### Filler Kit & Fitting Flange

Item Code 008255	Flange for Plastic (fixed) Water Tanks
Item Code 008271	Filler Kit for allWater Tanks Hose Connections 38-50-60mm (straight and 90°)



## Polyethylene tanks

Drinking-water Tanks made of Polyethylene. Colour Green  
 These Tanks come complete with a Fitting Flange  
**(Item Code 008255)** and not with an Inspection  
 Flange as shown on these pictures.  
 Filler Kit **(Item Code 008271)**  
 has to be ordered separately.



### Net Gross

<b>Item Code 482101</b>	32l	35l	Dim. 450x390x200 (+30)mm (LxWxH)
<b>Item Code 482102</b>	39l	43l	Dim. 550x390x200 (+30)mm (LxWxH)
<b>Item Code 482103</b>	45l	51l	Dim. 650x390x200 (+30)mm (LxWxH)
<b>Item Code 482104</b>	52l	59l	Dim. 750x390x200 (+30)mm (LxWxH)
<b>Item Code 482105</b>	60l	66l	Dim. 850x390x200 (+30)mm (LxWxH)
<b>Item Code 482106</b>	65l	74l	Dim. 950x390x200 (+30)mm (LxWxH)

<b>Item Code 482107</b>	47l	51l	Dim. 450x390x290 (+30)mm (LxWxH)
<b>Item Code 482108</b>	57l	62l	Dim. 550x390x290 (+30)mm (LxWxH)
<b>Item Code 482109</b>	67l	74l	Dim. 650x390x290 (+30)mm (LxWxH)
<b>Item Code 482110</b>	77l	85l	Dim. 750x390x290 (+30)mm (LxWxH)
<b>Item Code 482111</b>	87l	96l	Dim. 850x390x290 (+30)mm (LxWxH)
<b>Item Code 482112</b>	97l	107l	Dim. 950x390x290 (+30)mm (LxWxH)

## Polyethylene tanks

Colour white. These Tanks come complete with Fitting Flange  
**(Item Code 008255)** as shown on these pictures.

Filler Kit **(Item Code 008271)** has to be ordered separately.

### Net

<b>Item Code 482115</b>	100l	Dim. 910x300x410 (+30) mm (LxWxH)
<b>Item Code 482116</b>	100l	Dim. 910x410x300 (+30) mm (LxWxH)

**Item Code 482120** 190l A=1230, B=570, C=290, D=330

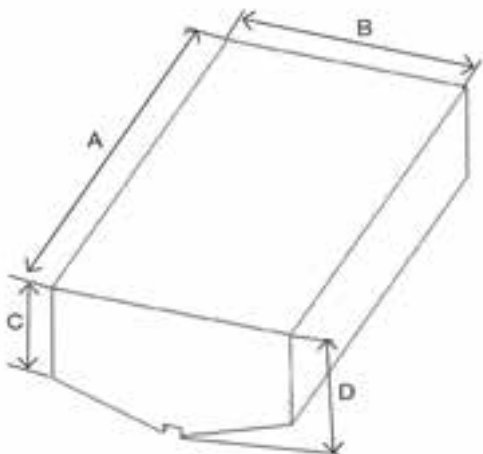

## Drinking-water Tanks made of Polyethylene green

008255

3/8"  
internal thread,  
flange ø 175mm

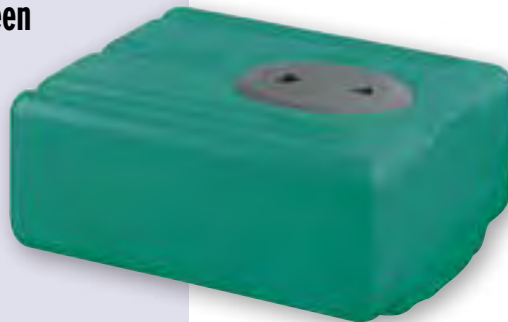

482101



482105



482115



482116

## Drinking-water Tanks made of Polyethylene white



483590

allpa® water boilers utilize the heat of the boat's engine cooling system to produce hot water. Alternatively, electric heating is possible too.

**Features:**

- Isolated with thick foam of expanded polyurethane.
- Heat loss less than 1°C per hour.
- Stainless steel mounting brackets.
- Huge production of hot water by the engine.
- Adjustable safety thermostat (0°C tot 70°C)
- Pressure relief (6 ± 0,5 bar).
- Non-return valve preventing backflow from cold water.
- Heater tested at 8 bar!
- Internal inspection possible by removing the brass mounting flange.

A magnesium anode is placed inside the tank of the enamelled tank. There is no magnesium anode for de S/S boilers.

**Attention: It is not allowed to switch on the electric power if the boiler has not been filled with water completely.**

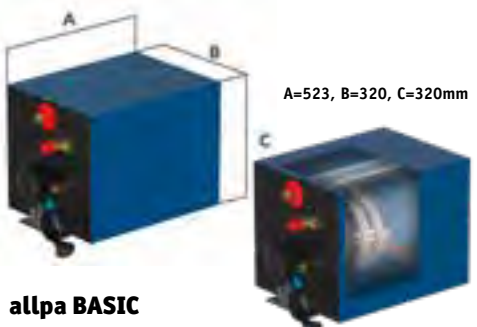

A=523, B=320, C=320mm

**allpa® Water boilers**

**NEW**

**allpa BASIC**

Item Code	Power	Voltage	Capacity	Weight	Model
051422	850W	230V	22l	13kg	Square
051423	850W	230V	22l	13kg	Round
051430	850W	230V	30l	14kg	Round

allpa basic water boilers with coating of opal glass at the inside of the tank and coated aluminium outer jacket.



A=390, B=413, C=397mm

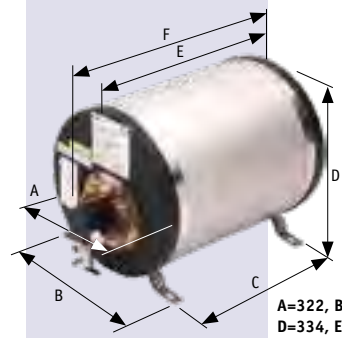

A=322, B=267, C=335, D=334, E=410 & F=485mm

**allpa STANDARD**

Item Code	Power	Voltage	Capacity	Weight	Model
051520	550W	230V	20l	13kg	Rectangular
051620	1200W	230V	20l	13kg	Rectangular
051522	500W	230V	22l	14kg	Round
051622	1200W	230V	22l	14kg	Round

allpa standard water boilers with coating of opal glass at the inside of the tank and anodized aluminium casing.

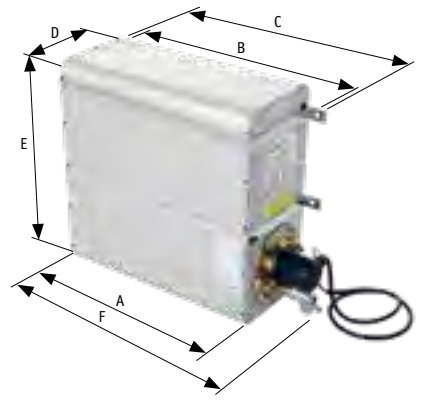

A=420, B=457, C=488, D=190, E=420 & F=485mm

**allpa LUXURY**

Item Code	Power	Voltage	Capacity	Weight	Model
051822	800W	230V	22l	14kg	Round
051621	1200W	230V	22l	14kg	Round

allpa luxury water boilers with stainless steel tank and stainless steel casing.

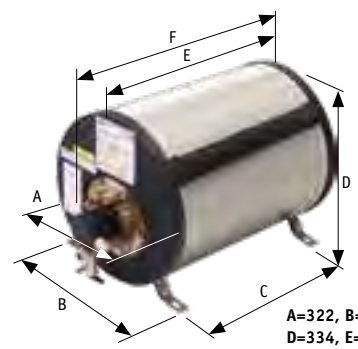

A=322, B=267, C=335, D=334, E=410 & F=485mm

**For accessories see page. 474**

Stainless steel water heaters with dual heating as standard electrical heating and indirect heating based on a second heat source, for example based on the cooling system from the Marine engine or generator set.

**AquaH** is a new innovative series of AISI 316 stainless steel water heaters, with storage capacity of 22 up to 80 l.

**Features:**

- Cased in AISI 316 stainless steel.
- Sturdy compact plastic end cover.
- Heat isolated by polyurethane foam.
- Heat loss less than 1°C per hour.
- Huge production of hot water by the engine.
- Adjustable safety thermostat (0°C tot 70°C)
- Pressure relief (6 ± 0,5 bar)
- Heater tested at 8 bar!
- Non-return valve preventing backflow from cold water.
- Engine ware fittings ½" BSP

**Attention: It is not allowed to switch on the electric power, if the boiler has not been filled with water completely!**

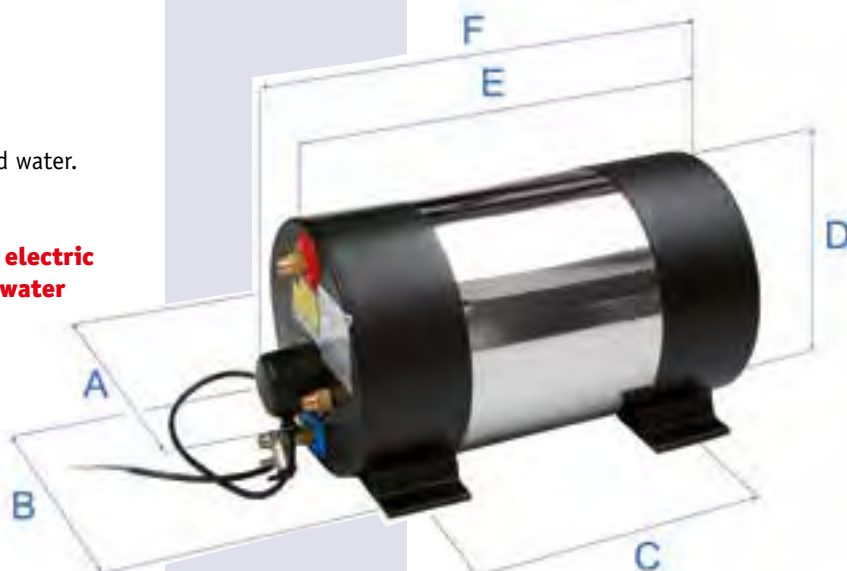
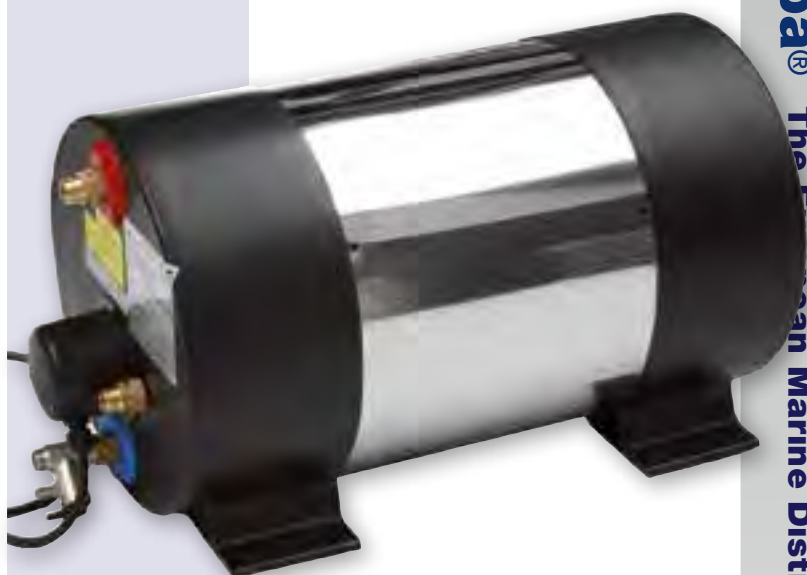

Item Code	Power	Voltage	Capacity	Weight	A	B	C	D	E	F	Model
	W	v	l	kg	mm	mm	mm	mm	mm	mm	
66-56-47455-01	1200	230	22	10	322	290	235	325	410	485	Round, S/S
66-56-47455-03	500	230	22	10	322	290	235	325	410	485	Round, S/S
66-56-47456-01	1200	230	30	11,5	322	290	370	325	545	620	Round, S/S
66-56-47456-03	500	230	30	11,5	322	290	370	325	545	620	Round, S/S
66-56-47457-01	1200	230	45	15	322	290	625	325	805	880	Round, S/S
66-56-47457-03	500	230	45	15	322	290	625	325	805	880	Round, S/S
66-56-47458-01	1200	230	60	17,3	322	290	810	325	990	1065	Round, S/S
66-56-47458-03	500	230	60	17,3	322	290	810	325	990	1065	Round, S/S
66-56-47459-01	1200	230	80	20	322	290	1030	325	1210	1285	Round, S/S
66-56-47459-03	500	230	80	20	322	290	1030	325	1210	1285	Round, S/S

For accessories see page. 474

**Replacement parts for:**

- **allpa** Water Heaters
- **AquaH** Water Heaters

66564746401  
AquaH Thermostat  
Water Mixer Kit



1. Cold Water Inlet: 1/2"
2. Hot Water Outlet: 1/2"
3. Inlet Engine Coolant: 1/2", 17mm
4. Outlet Engine Coolant: 1/2", 17mm

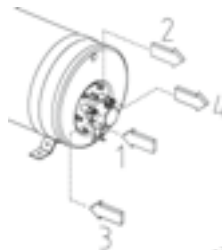

For Hot Water Hoses:  
Please see p. 465

ISO9001  
CE conform 2006/95/CE (low voltage)  
& 89/336/CEE (electromagnetic compatibility)

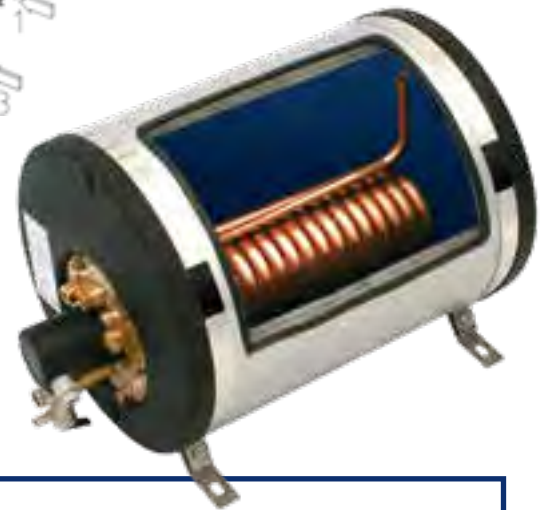

Code	Replacement parts:	Code	
051955	500W Heating Element: 1-1/4"	051896	Magnesium Anode Boiler 19, 20, 22 & (30 l-2009)
051958	800W Heating Element: 1-1/4"	051909	Gasketing Magnesium Anode. Plug <b>051910</b>
051962	1200W Heating Element: 1-1/4"	051901	Temperature Controller
051907	Gasket Heater	051906	Gasket Mounting Flange
051897	Magnesium Anode Boiler 12l	051914	Pressure relief valve + non return valve 1/2"
051898	Magnesium Anode Boiler 45 & 60l (2009)		
051899	Magnesium Anode Boiler 100l (2009)	66564746401	AquaH Thermostat/Water Mixer Kit

**Replacement parts for:**

- **Nico** Water Heaters



Item Code	Replacement parts:	Item C.	
100266	Temperature Controller 230V	100319	Drain Valve
100269	660W Heating Element 230V with gasket	100320	Drain Plug
100271	200W Heating Element 12V with gasket	100322	Pressure Relief 3,0 Bar 1/2"
100277	400W Heating Element 24V with gasket	100351	Temperature Controller 12/24V
100298	Temperature Controller knob		

1. Water tank
2. PUMProtector inlet strainer
3. Aqua Jet water pressure pump
4. Battery
5. Fuse
6. Switch
7. Accumulator tank
8. Water heater
9. ON/OFF bipolar switch
10. Motor
11. Check valve
12. Shut-off valve

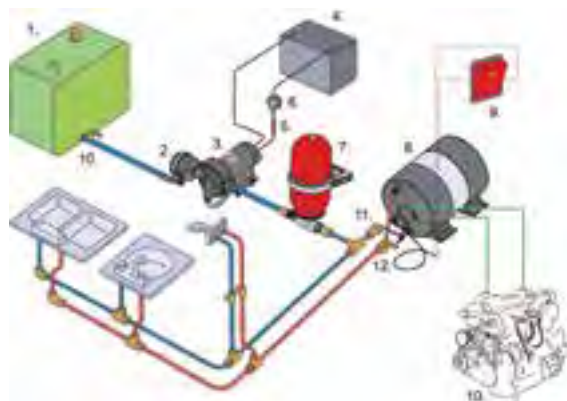

Waterheater Nico is an electrical boiler that operates on 12V, 24V and 230V. Due to its size it is easy to install in small spaces. There are two models that are available in different voltages.

**Features:**

- AISI 316 boiler
- Available in 12V, 24V or 230V
- Adjustable safety thermostat (30 tot 85 °C)
- Pressure relief 3 bar.
- 1m Power Cable (230V with plug)
- Compact water heater
- Hose connector 10mm
- Produced in Germany
- Empty boiler via the drain valve

**Attention: It is not allowed to switch on the electric power if the boiler has not been filled with water completely.**



NICO 6L



NICO 10L

**ALSO IN 12 OR 24 VOLT**



Item Code	Power W	Voltage V	Capacity l	Weight kg	B mm	H mm	D mm	Model
100467	660	230	6	2,8	220	230	410	Nico 6l 230V
100468	200	12 DC	6	2,8	220	230	410	Nico 6l 12V
100469	400	24 DC	6	2,8	220	230	410	Nico 6l 24V
100471	660	230	10	4,5	220	230	570	Nico 10l 230V
100472	200	12 DC	10	4,5	220	230	570	Nico 10l 12V
100473	400	24 DC	10	4,5	220	230	570	Nico 10l 24V

For accessories see page. 474



### Aqua Jet Wash Down Pump 5.2 suitable for seawater

As a wash down pump, the Aqua Jet offers much higher pressures than competitive models, making clean-up faster and easier than ever before. Complete with trigger nozzle, PUMProtector inlet strainer and hose connections for 1/2" hose.

Item Code	Description
66-32-64534	Aqua Jet 5.2 Wash down pump 12V
66-32-64534-R24	Aqua Jet 5.2 Wash down pump 24V

**Accessories**

Item Code	Description
66-80-47507	Stainless steel quick connect bulkhead fitting. It is possible to connect or disconnect under full pressure. 3/4" hose. Rear connection 1/2"
66-09-10616	Plastic bulkhead fitting 3/4" hose connection and ball valve
66-34-82004	Control panel 12V
66-34-82004-24	Control panel 24V



### Bulkhead Fitting

66-80-47507

66-09-10616



### AQUA JET 5.0 "FLOW MASTER" Water Pressure System

The Flow Master 5.0 is a five chamber positive displacement diaphragm pump that is an ideal choice for pressurizing water in a closed system. The digital controller adjusts water flow as the demand is increased and decreased while maintaining a very smooth flow. The unique variable flow feature of the FlowMaster pump allows the pump to be mounted without an accumulator tank and still maintain an even flow regardless if one or multiple taps are being used. The Flow Master pump comes complete with a PUMProtector inlet strainer. Strainer inclusive.

Dims.:	239 x 209 x 113mm (lxbxh)
Weight:	2kg
Motor:	WPS 5.0 – 150W, 12/24DC (with built-in thermal safety cut-off switch)
Body:	Nylon/propylene
Valves:	Santoprene/EPDM
Diaphragm:	Santoprene

Item Code	Description	Capacity	Working pressure	Fuse	Connection
6610-13329-03	WPS FM 5.0 12V	19L/min – 5GPM	3.5 bar/50 psi	15 A	3/8" BSP / hose 1/2", 1/2" BSP / hose 3/4"
6610-13329-04	WPS FM 5.0 24V	19L/min – 5GPM	3.5 bar/50 psi	8 A	3/8" BSP / hose 1/2", 1/2" BSP / hose 3/4"



### PUMProtector™ Strainer

Item Code 66-09-24652-01	Universal inline strainer Connections: 2 x straight 1/2" hose - 3/8" BSP 2 x straight 3/4" hose - 1/2" BSP
Item Code 66-09-24653-01	Inlet strainer Connections: 2 x straight 1/2" hose - 3/8" BSP 2 x straight 3/4" hose - 1/2" BSP

5-Chamber diaphragm pump.  
See also WPS 2.9. Capacity 9 l/min.  
Working pressure 2.8 bar.  
Self priming up to 2 m. Motor 87 W.  
Dims.: 200x 197 x 114mm. Weight 1.6kg.



**Item Code 66-10-24604-03 12V**  
**Item Code 66-10-24604-04 24V**  
**Item Code 66-10-24604-YG (12V incl. strainer)**

## Aqua Jet WPS 2.4 Water Pressure System



The five chamber Aqua Jet WPS-series provide a reliable heart for small boat and recreational vehicle water pressure system. Compared to conventional three or four-chamber diaphragm pumps, the Aqua Jet demonstrates dramatically lower noise and water pulsation characteristics. Smooth and pulsation-free flow due to the five chamber design. It is recommended to install the WPS-pumps with an accumulator tank. Always use a PUMProtector inlet strainer before the pump intake.

### Dimensions and weight

Model	WPS2.9	WPS3.5	WPS4.0	WPS5.2
Diaphragma	Santoprene	Santoprene	Santoprene	Santoprene
Valves	EDPM	EDPM	EDPM	EDPM
Body	PP/PPA	PP/PPA	PP	PP
Motor	90W	100W	100W	100W
Weight	1.6kg	2kg	2kg	2kg
Length	204mm	236,5mm	240mm	240mm
Width	197mm	210mm	214mm	214mm
Height	110mm	116mm	110mm	110mm

## Aqua Jet WPS 2.9, WPS 3.5, WPS 4.0, WPS 5.2 Water Pressure Systems



WPS 2.9



WPS 3.5



WPS 4.0



WPS 5.2

WPS 2.9							
Item Code	Description	Capacity	Pressure Cut-in	Pressure Cut-off *	Fuse	Connection**	
6610-13405-03	Aqua Jet WPS 2.9 12V	11L/min / 2.9 GPM	1.7 bar / 2psi	2.8 bar / 41psi	10A	3/8" BSP / hose 1/2", 1/2" BSP / hose 3/4"	
6610-13405-04	Aqua Jet WPS 2.9 24V	11L/min / 2.9 GPM	1.7 bar / 24psi	2.8 bar / 41psi	5A	3/8" BSP / hose 1/2", 1/2" BSP / hose 3/4"	
WPS 3.5							
Item Code	Description	Capacity	Pressure Cut-in	Pressure Cut-off *	Fuse	Connection**	
6610-13395-03	Aqua Jet WPS 3.5 12V	13L/min / 3.5 GPM	1.7 bar / 24psi	2.8 bar / 41psi	10A	3/8" BSP / hose 1/2", 1/2" BSP / hose 3/4"	
6610-13395-04	Aqua Jet WPS 3.5 24V	13L/min / 3.5 GPM	1.7 bar / 24psi	2.8 bar / 41psi	5A	3/8" BSP / hose 1/2", 1/2" BSP / hose 3/4"	
WPS 4.0							
Item Code	Description	Capacity	Pressure Cut-in	Pressure Cut-off *	Fuse	Connection**	
6610-13406-03	Aqua Jet WPS 4.0 12V	15L/min / 4.0 GPM	1.7 bar / 24psi	2.8 bar / 41psi	10A	3/8" BSP / hose 1/2", 1/2" BSP / hose 3/4"	
6610-13406-04	Aqua Jet WPS 4.0 24V	15L/min / 4.0 GPM	1.7 bar / 24psi	2.8 bar / 41psi	5A	3/8" BSP / hose 1/2", 1/2" BSP / hose 3/4"	
WPS 5.2							
Item Code	Description	Capacity	Pressure Cut-in	Pressure Cut-off *	Fuse	Connection**	
6610-13406-07	Aqua Jet WPS 5.2 12V	20L/min / 5.2 GPM	1.7 bar / 24psi	2.8 bar / 41psi	15A	3/8" BSP / hose 1/2", 1/2" BSP / hose 3/4"	
6610-13406-08	Aqua Jet WPS 5.2 24V	20L/min / 5.2 GPM	1.7 bar / 24psi	2.8 bar / 41psi	8A	3/8" BSP / hose 1/2", 1/2" BSP / hose 3/4"	

\* Cut-Off pressure 2.1 bar/30 psi and  
4 bar/20 psi available on request

\*\* NPT- connection available on request

**Max. Watertemp 50°C**

### WPS 3.5:

Fitted with built-in pulsation dampening by-pass valve.



Johnson  
Pump®



**Water Pressure System**

**INOX 66B Water Pressure System**

Stainless Steel tank with pump and impeller made of bronze  
 Capacity at 0,7bar: 12l/min  
 Capacity at 1,6bar: 6l/min  
 Suitable for 2-4 taps. Tank 2l  
 Available in 12 & 24V. Power 185W  
 Self priming up to 5,5m  
 Hose connection 20mm. Weight 6,7kg  
 Dims. 330 x 200 x 260mm.  
 Fuse at 12V: 20A, at 24V: 10A.



**Item Code 086040** INOX 66B-12V

**Item Code 086041** INOX 66B-24V



**Item Code 086514** Spare pressure switch (D9013) for INOX & AMFA-systems

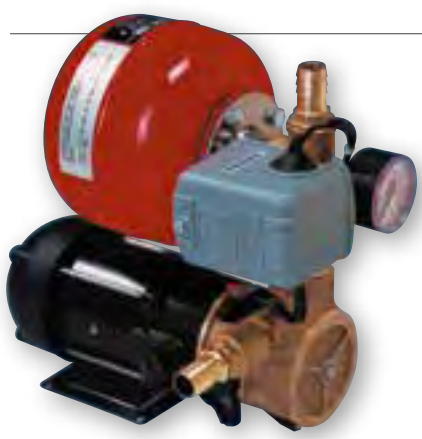

**Water Pressure System**

**AMFA 66B Water Pressure System**

Stainless Steel tank with pump and impeller made of bronze  
 Capacity at 0,7bar: 12l/min  
 Capacity at 1,6bar: 6l/min  
 Suitable for 2-4 taps. Tank 2l  
 Available in 12 & 24V. Power 185W  
 Self priming up to 5,5m  
 Hose connection 20mm. Weight 6,7kg  
 Dims. 330 x 200 x 260mm.  
 Fuse at 12V: 20A, at 24V: 10A.

**Item Code 086042** AMFA 66B-12V

**Item Code 086043** AMFA 66B-24V



**Water Pressure System**

**INOX 950 Water Pressure System**

Tank, pump and impeller made of Stainless Steel  
 Capacity at 1,2bar: 52l/min  
 Capacity at 2,7bar: 23l/min  
 Suitable for »10 taps. Tank 24l  
 Available in 12V, 24V, 230V & 400V. Power 370W  
 Self priming up to 5,5m  
 Hose connection 25mm. Weight 19,7kg (12/24V)  
 Weight 15,5kg (230/400V).  
 Dims. 640 x 300 x 550mm.  
 Fuse at 12V: 32A, at 24V: 25A, at 230V: 6A, at 400V: 3A



**Item Code 086050** INOX 950-12V

**Item Code 086051** INOX 950-24V

**Item Code 086052** INOX 950-230V

**Item Code 086053** INOX 950-400V

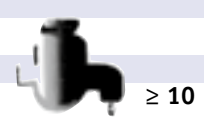

**Water Pressure System**

**AMFA 990 Water Pressure System**

Steel tank with pump and impeller made of Technopolymer  
 Capacity at 1,2bar: 52l/min  
 Capacity at 2,7bar: 23l/min  
 Suitable for » 10 taps. Tank 24l  
 Available in 12V, 24V, 230V & 400V. Power 370W  
 Self priming up to 5,5m  
 Hose connection 25mm. Weight 15,6kg  
 Dims. 770 x 235 x 490mm.  
 Fuse at 12V: 32A, at 24V: 25A, at 230V: 6A, at 400V: 3A



**Item Code 086060** AMFA 990-12V

**Item Code 086061** AMFA 990-24V

**Item Code 086062** AMFA 990-230V

**Item Code 086063** AMFA 990-400V





**AQUA JET UNO**

Medium demand unit with a single Aqua Jet WPS with capacity of 13 or 19l/min, fixed on a base with PUMProtector inlet strainer and a pre-pressurized 2l accumulator tank  
Horizontal or vertical mount.  
L=365mm, W=213mm, H=249mm

The system consists of:

- 1 Aqua Jet Pump 13l or 20l/min
- 1 inlet strainer
- 1 accumulator tank 2l
- complete pre-mounted on a base
- Cut-off pressure 2.8bar
- Hose connections 3/4"

**Item Code 66-10-13408-01** Aqua Jet Uno 13l/min.,12V/10A

**Item Code 66-10-13408-02** Aqua Jet Uno 13l/min., 24V/5A

**Item Code 66-10-13408-03** Aqua Jet Uno 20l/min.,12V/10A

**Item Code 66-10-13408-04** Aqua Jet Uno 20l/min., 24V/5A

Aqua Jet Uno



**AQUA JET DUO**

High demand unit with two parallel-connected Aqua Jet WPS with capacity of 36l/min, fixed on a base with PUMProtector inlet strainers and a pre-pressurized 2l accumulator tank.  
L=365mm, W=213mm, H=373mm



Cut-off pressure 2.8bar/41psi

Hose connections 3/4"

**Item Code 66-10-13409-01** Aqua Jet Duo 36 l/min.,12V/25A

**Item Code 66-10-13409-02** Aqua Jet Duo 36 l/min.,24V/15A

Aqua Jet Duo



**AQUA JET UNO MAX**

Medium demand unit with a single Aqua Jet WPS with capacity 11 of 13 l/min, fixed on a wooden panel for easy and efficient installation. The unit includes a PUMProtector inlet strainer and a pre-pressurized 2l accumulator tank

Replaces Jabsco Ultra Max

Max Cut-off pressure 2.8bar/41psi

Hose connections 1/2"

**Item Code 66-10-13410-01** Aqua Jet Uno Max 11l/min.,12V/10A

**Item Code 66-10-13410-02**Aqua Jet Uno Max 11l/min., 24V/5A

**Item Code 66-10-13411-01**Aqua Jet Uno Max13l/min.,12V/10A

**Item Code 66-10-13411-02** Aqua Jet Uno Max 13l/min.,24V/5A

Aqua Jet Uno Max



Volume 2,0l

Pre-pressurized at 0,8bar

Working pressure max 12bar

Dims. 315 x 160mm (h xØ)

Weight 1,2kg

Steel tank with corrosion protection

**Item Code 66-09-46839-01** Hose connection 13mm (1/2")

**Item Code 66-09-46839-02** Hose connection 19mm (3/4")

Accumulator Tank



Volume 1,0l

Max. working pressure 3,0 bar (at 20°C)

Plastic tank

Weight 0,2kg

**Item Code 000105** Hose connection 13mm (1/2")

Accumulator Tank



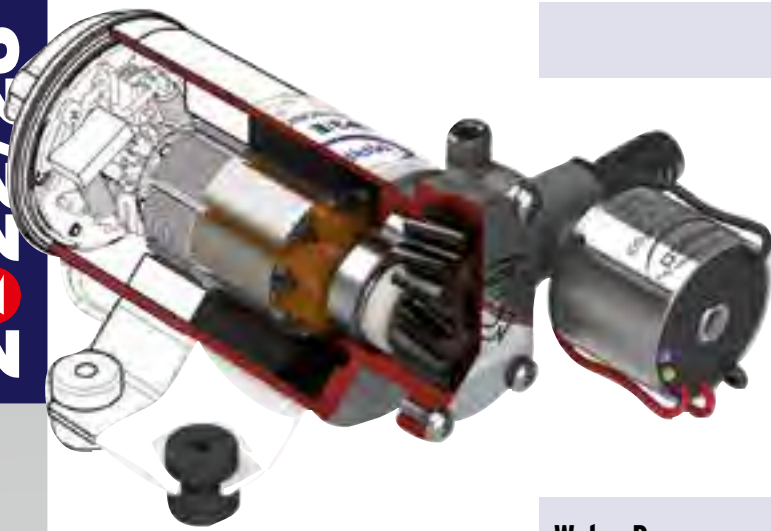

**Self-priming shower- and deckwashkit with electronic pressure control. Pump functions monitored by LED. Blue flashing LED indicating empty tank.**

**Features:**

- Selfpriming gear pump
- Constant waterflow
- Smart Sensor with LED indication
- Energy efficient
- Proportional reduction of noise
- Helical PTFE Gears

**Water Pressure System Showerkit**



Item code	06150
Discription	PA2
Voltage	12/24V
Capacity	10l/min
Max. pressure	2.0 bar/29 psi
Fuse	7,5A
Connection	3/8" BSP
Inline strainer	No
Control panel	No

**Water Pressure System with Deckwashkit**



Item code	06155
Discription	PA12/E
Voltage	12/24V
Capacity	15l/min
Max. pressure	5.0 bar/72,5 psi
Fuse	30A
Connection	1/2" BSP
Inline strainer	Yes
Control panel	No

**Quick connection for washingpump**



Item code	06160
Discription	PAQ Quick connection for washingpump PA12/E
Mounting	Ø 78mm

**Self-priming shower- and deckwashkit with electronic pressure control. Compact pressure system for use in smaller boats and campers. Pump functions monitored by LED. Blue flashing LED indicating empty tank.**

**Features:**

- Selfpriming gear pump
- Constant waterflow
- Smart Sensor with LED indication
- Energy efficient
- Proportional reduction of noise
- Helical PTFE Gears
- Nickel-plated brass casing



<b>Item code</b>	<b>06165</b>
Discription	ALL2/E
Voltage	12/24V
Capacity	10l/min
Max. pressure	2.0 bar/29 psi
Fuse	7,5A
Connection	3/8" BSP
Inline strainer	No
Control panel	No

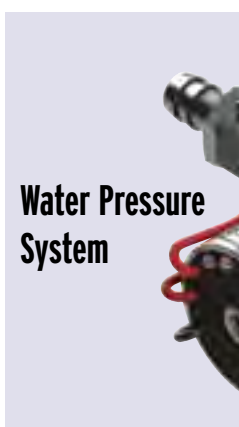

<b>Item code</b>	<b>06170</b>
Discription	ALL3/E
Voltage	12/24V
Capacity	15l/min
Max. pressure	2.5 bar/36 psi
Fuse	15A
Connection	3/8" BSP
Inline strainer	Yes
Control panel	Optional

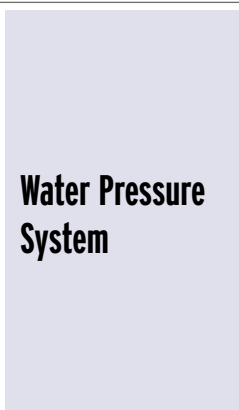

<b>Item code</b>	<b>06175</b>
Discription	ALL6/E
Voltage	12/24V
Capacity	26l/min
Max. pressure	2.5 bar/36 psi
Fuse	20A
Connection	1/2" BSP
Inline strainer	Yes
Control panel	Optional

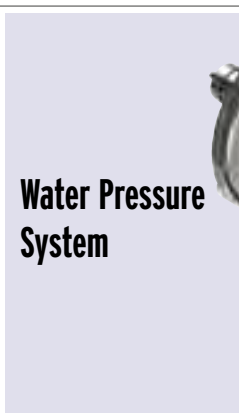

<b>Item code</b>	<b>06180</b>
Discription	PCS Control Panel for ALL3/E and ALL6/E

<b>Item code</b>	<b>06181</b>
Discription	Inlet strainer 3/8" BSP

<b>Item code</b>	<b>06182</b>
Discription	Inlet strainer 1/2" BSP

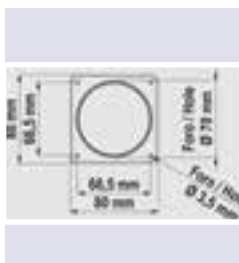



### Johnson Cartridge Bilge Pumps L-Series

#### Cartridge Bilge pumps

Improved design with easy-to-install Dura-Port discharge ports to eliminate stress cracking caused by over-tightened hose clamps. The pumps will be delivered including both a straight and a 90° smooth elbow (except L750)

Johnson Pump®



Model	L450	L550	L650	L750
Hose connections	3/4"	3/4"	3/4"	1- 1/8"
Capacity l/min.	49	56	61	73
Capacity by 1m.	38	45	53	60
Max. Head	2,5m	2,6m	3,5m	2,6m
Volt	12V	12V	12V	12V
Current draw	2,5A	3,0A	3,2A	3,0A
Fuse	3A	5A	5A	5A
Height	112mm	112mm	112mm	112mm
Diameter	70mm	70mm	70mm	70mm
Weight	0,27kg	0,27kg	0,27kg	0,32kg
Body	Thermoplastic	dito	dito	dito
Seal	Lip Seal	Lip Seal	Lip Seal	Lip Seal
Electric Cable	0,75mm <sup>2</sup>	0,75mm <sup>2</sup>	0,75mm <sup>2</sup>	0,75mm <sup>2</sup>
Item Code 12V	66-321450-01	66-321550-01	66-321650-01	66-321750-01
Item Code 24V	-	-	66-321650-01-24	66-321750-01-24



### Bilge Mate

A low budget alternative designed for long life and high performance capacity. Capacity, straight: 30 L/min, 12 V/2A. Max diam.: 115mm, height: 100mm. Connection: 3/4" (19mm), weight: 0.35kg  
**Item Code 66-321015-01** 12V



### Ultima Bilge™

UltimaBilge™ Pumps are the latest addition to the Johnson Pump lineup. Integration of the patented Ultima "field effect" sensing technology into the bilge pump body creates a sleek, reliable compact, unit ready to install and run for years and years of unerring service. All version are delivered with a removable check valve. Dimensions: L=142mm, W=82mm, H=105mm. Weight: 0.66kg

Item Code	Model	Capacity (1m , 13,6V)	Capacity (straight , 13,6V)	Amp.	Fuse	Connections
66-32-47258	600GPH 12V	32L/min.	38L/min.	2,5A	5A	3/4"
66-32-47259	800GPH 12V	38L/min.	51L/min.	3A	5A	3/4"
66-32-47260	1000GPH 12V	44L/min.	64L/min.	3,2A	5A	3/4"
66-32-47261	1250GPH 12V	51L/min.	79L/min.	3A	5A	1 1/8" and 1 1/4"
Item Code 6699990	Spare check valve (duck mouth)					

Johnson Pump®



### Low Boy Bilge Pump

Low Profile pump design for ease of mounting and removal in tight bilge areas. Perfect for vessels with bilge pumps mounted beneath inboard or I/O engines. Removable cartridge style. The pumps will be delivered including both a straight and a 90° smooth elbow Dura-Port as well as a removable check valve.

Dims. 146 x 81 x 72mm (l x w x h)  
 Power absorption 3A. Fuse 5A.

- Item Code 66-32-33703LB-01** Low Boy, type L550, 12 V, 50 l/min, 3/4" connection
- Item Code 66-32-33103LB-01** Low Boy, type L750, 12 V, 73 l/min, 1 1/8" connection



## Johnson Pump®

### L1600

Capacity:	100 l/min at 1 m head
Max head:	5 m
Power consumption:	7 A – 12 V / 3.5 A – 24 V
Connection:	1-1/8" (28.5mm) & 1/4" (32mm)
Shaft seal:	Lip seal
Dimensions:	Max Ø108mm, h = 149mm
Weight:	1.3kg

**Item Code 66-32-1600-01** 12V

**Item Code 66-32-1600-02** 24V

### L2200

Capacity:	130 l/min, 120 l/min at 1 m head
Max head:	5 m
Power consumption:	7.5 A – 12 V / 4.5 A – 24 V
Connection:	1-1/8" (28.5mm) & 1/4" (32mm)
Shaft seal:	Mechanical seal
Dimensions:	Max Ø108mm, h = 177mm
Weight:	2.25kg

**Item Code 66-32-2200-01** 12V

**Item Code 66-32-2200-02** 24V

### L4000

Capacity:	252 l/min, 164 l/min at 1 m head
Max head:	7.6 m
Power consumption:	15 A – 12 V / 7.5 A – 24 V
Connection:	1 1/2" (38) & 2" (51mm)
Shaft seal:	Mechanical seal
Dimensions:	Max Ø121mm, h = 216mm
Weight:	2.7kg

**Item Code 66-32-4000-01** 12V

**Item Code 66-32-4000-02** 24V



### L1600, L2200, L4000 Bilge pumps

With removable check valve

**Item Code 66-34888** 12/24V

This switch has a time-proven micro switch without mercury, activated by a rolling steel ball. Attaches to any Johnson Bilge pump. Max 15A

### Automatic Switch

Built on the same concept as the switch on the Cartridge Duo Pumps.

**Item Code 66-34-1900B12** (12V) Capacity 12V-15A

**Item Code 66-34-1900B24** (24V) Capacity 24V-10A

### Electronic Float Switch

92mm

88mm

56mm

New digital technology uses the patented Mirus field effect detector cells producing micro-electrical fields that detect disruptions caused by water and fluids. Detector cells are totally sealed, never in contact with the water, will not corrode and are not affected by oil or foreign debris. Nomoving parts, totally sealed solid state electronics and field detectors, no mercury and no exposed sensors eliminate corrosion possibilities and makes the ULTIMA switch environmentally sensitive. ULTIMA activates at a 50mm (2") fluid level and deactivates at a 20mm (3/4") fluid level. An 8 sec. delay prevents false starts. Rated up to 20A at 12 or 24V.

**Item Code 66-34-36303** Ultima Electronic Level Switch, 12/24V.

### ULTIMA Electronic Level Switch

High Water Alarm featuring new digital technology using the patented Mirus field effect cell. Totally sealed fluid detector never contacts water, will not corrode and is not affected by oil or debris. Bilge Alert detects water and sends a signal to the alarm (90db) and switch conveniently mounted on a panel. Three way rocker switch allows alarm to be tested, turned off and armed.

**Item Code 66-34-72303** Bilge Alert, 12V

**Item Code 66-34-72303-24** Bilge Alert, 24V

### "Bilge Alert"

Exclusive fuse but with three way rocker switch: Automatic, Manual and Off. Illuminated switch. Dims. 76 x 55 x 40mm (w x h x d)

**Item Code 66-34-1224** 12 V

**Item Code 66-34-1225** 24 V

### Bilge Pump Control



**allpa  
Mini-Midi-Maxi  
Bilge Pump**

allpa Mini, Midi, Maxi Bilge Pumps. Equipped with Stainless Steel 316 shaft. Saltwater resistance, with high-impact durable plastic housing.

<b>Item Code 018400</b>	<b>Mini</b>	1.8A	27l/min	12V	19mm
<b>Item Code 018405</b>	<b>Midi</b>	3A	50l/min	12V	24mm
<b>Item Code 018410</b>	<b>Maxi</b>	4A	75l/min	12V	29mm



**allpa  
Heavy Duty  
Bilge Pump**

Heavy Duty Bilge Pumps with check valve. Equipped with Stainless Steel 316 shaft and double ball bearing motor with mechanical seal. ISO 8848 Marine EN 55014. Dims. 170x158x130mm Hose connections: 32 or 38mm

<b>Item Code 018420</b>	7.5A	110l/min	12V
<b>Item Code 018425</b>	4A	110l/min	24V
<b>Item Code 018430</b>	9A	135l/min	12V
<b>Item Code 018435</b>	4.5A	135l/min	24V



<sup>3</sup>/<sub>4</sub>" - 19/29mm

**allpa Bilge Pump  
with integrated  
Float Switch**

Bilge pump with integrated float switch and 19mm hose connection.

Dims. 151 x 80 x 104mm

<b>Item Code 018112</b>	12V/1.8A	32l/min	19mm
<b>Item Code 018124</b>	12V/3.0A	48l/min	19mm
<b>Item Code 018136</b>	12V/4A	75l/min	29mm
<b>Item Code 018148</b>	24V/2.5A	75l/min	29mm



**allpa Automatic  
Switch**

Automatic Switch for 12V and 24V Bilge Pumps. ISO 8846. Max. 15A Dims. 110x70x50mm

<b>Item Code 018350</b>	Automatic Switch 12/24V
-------------------------	-------------------------



**allpa Electronic  
Level Switch**

Electronic Level Switch for 12V and 24V Bilge Pumps. Switch activates at 50mm and deactivates a 20mm fluid level. ISO 8846 Marine EN 5501. Max. 20A Dims. 110x70x50mm

<b>Item Code 018360</b>	Electronic Level Switch
-------------------------	-------------------------



**allpa Bilge Pump  
Strainer**

Strainer for use with a bilge pump. Can be mounted in inaccessible areas. 18, 20 and 22mm hose connectors. Dims. 145x80mm

<b>Item Code 018370</b>	Bilge Pump Strainer PVC
-------------------------	-------------------------

Manual Bilge and Waste water pump  
 PP-body with stainless steel shaft and nitrile diaphragm and valves.  
 Dims: Ø164mm, H=133mm, max. width 253mm  
 Max. head 4m, hose connections 1½" (Ø38mm).  
 Average capacity at 1m head: 95l/min.

**Item Code 66-70-50005** "Viking" Pump, wall mount with cover seal

**Item Code 66-70-50007** "Viking" Pump, horizontal mount

### Viking Manual Bilge Pump Thrudeck and Bulkhead



Viking Compact Manual Bilge Pump  
 Very sleek diaphragm pump. Cover is handle !  
 Hose connections Ø25mm (1") and Ø38mm (1½") swivel 360°.  
 Combined head/lift 3,3m  
 Average capacity at 1m head: 45l/min (Ø38mm port)

**Item Code 66-10-24800-01**

### Viking Compact Manual Bilge Pump



Very sleek diaphragm pump. Cover is handle !  
 Hose connections Ø25mm (1") and Ø38mm (1½") swivel 360°.  
 Combined head/lift 3,3m Average capacity at 1m head: 45l/min (Ø38mm port)

**Item Code P0218517**

### allpa Compact Manual Bilge Pump



Body nylon. Capacity 50l/min  
 Hose connection: Ø25mm

**Item Code P0218510**

### Manual Bilge Pump



**Item Code P0271601** Body Nylon.  
 Capacity 2724l/min.  
 Hose connection Ø33mm

### Heavy duty Manual Bilge Pump





### Nautical Bucket

**Item Code P001** Rubber Bucket. Extra sturdy.



### allpa Nautical Bucket "the Original"

**Item Code P002** PVC bucket 7,5L.  
With PVC handle



### Hand Suction Pumps with hose 800mm

**Item Code P0250035** L = 350mm  
**Item Code P0250055** L = 550mm  
**Item Code P0250075** L = 750mm

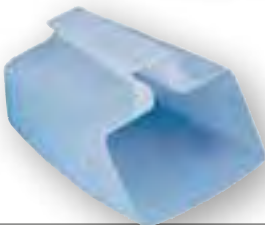

### Bailer

**Item Code P0000120** Bailer made of strong thermoplastic material



### Immersion Drinking-Water Pumps

Fits in a jerry can

**Item Code P0208035** Model CARAVEL  
Pump Ø35.5mm, Hose Ø9mm,  
12V/2.0A. Capacity 8.5l/min.  
**Item Code P0212052** Model CONCORDE  
Pump Ø52.0mm, Hose Ø11mm  
12V/2.5A. Capacity 12l/min.



### Oil change pump F3B-19 - "Oil Change"

The Johnson F3B-19 Oil Change Pump is a reversible rubber impeller pump with integrated quick reversing switch. The pump is designed to remove old oil from the engine, and then with the integral reversing switch., the flow direction can be changed to pump a measured amount of new oil back into the engine. Threaded Ports 3/8". Dims 170x113x115mm (lwxhxh). Capacity 12l/min.

**Item Code 66-10-24760-01** F3B19 Oil change, 12V  
**Item Code 66-10-24760-02** F3B19 Oil change, 24V  
**Item Code 66-09-843S-9** Replacement Impeller



### Pressure switch

**Item Code 66-09-45073**

Deck Wash Pumps can be provided with a pressure switch. This allows the pump to switch on automatically as soon as water is requested. Suitable for all self-priming, electric pumps and pumps with Electro-magnetic clutch. 230V AC - 16A / 12V DC - 16A Incl. 3/8" T-Fitting & non-return valve.



## DC Flexible Impeller Pumps

Max +80°C!



F2P10-19 is a fully equipped, self-priming multipurpose pump operating on a simple and uncomplicated principle. Ideal for pumping water, oils and chemicals. F3B-19, F38B-19, F4B-19 are perfect for bilge pumping, deckwash, water circulation, oil and diesel refuelling at dockside service, etc. F5B-19 is for bilge pumping, deckwash, water circulation, oil and diesel refuelling at dockside service, etc. The motor can be run continuously up to 0.5 bar \*) and for max 1 hour at 1 bar \*). Vacuum switch as extra accessory for F3B-19, F4B-19 and F5B-19, see below.

Pump	Item Code	Motor	Capacity (l/min)	Body	Impeller	Seal	Connection (mm)	Dims. lxbxh	Weight (kg)
F2P10-19	66-10-24886-01	12V	15	PTMT	66-09-1077B-9	Lip Seal	1/2" slang (13mm)	172x117x 78	1,6
F2P10-19	66-10-24886-02	24V	15	PTMT	66-09-1077B-9	Lip Seal	1/2" slang (13mm)	172x117x 78	1,6
F3B-19	66-10-24516-01	12V	21	Bronze	66-09-1052S-9	Lip Seal	3/8" BSP	170x113x 82	2,0
F3B-19	66-10-24516-02	24V	21	Bronze	66-09-1052S-9	Lip Seal	3/8" BSP	170x113x 82	2,0
F38B-19	66-10-24727-01	12V	35	Bronze	66-09-824P-9	Lip Seal	1/2" BSP & 1" slang	180x120x 90	3,0
F38B-19	66-10-24727-02	24V	35	Bronze	66-09-824P-9	Lip Seal	1/2" BSP & 1" slang	180x120x 90	3,0
F4B-19	66-10-24689-01	12V	48	Bronze	66-09-824P-9	Lip Seal	1/2" BSP & 1" slang	202x120x 90	3,0
F4B-19	66-10-24689-02	24V	48	Bronze	66-09-824P-9	Lip Seal	1/2" BSP & 1" slang	202x120x 90	3,0
F4B-11 Ultra Ballast	66-10-24690-01	12V	52	Bronze	66-09-824P-1	Lip Seal	1/2" BSP & 1" slang	202x120x 90	3,0
F4B-11 Ultra Ballast	66-10-24690-02	24V	52	Bronze	66-09-824P-1	Lip Seal	1/2" BSP & 1" slang	202x120x 90	3,0
F5B-19	66-10-24188-1	12V	55	Bronze	66-09-1027B-9	Glijring	3/4" BSP	258x131x120	8,0
F5B-19	66-10-24188-2	24V	55	Bronze	66-09-1027B-9	Glijring	3/4" BSP	258x131x120	8,0

NOTE! Do not use any of the pumps mentioned above for pumping paraffin or other thin petroleum products

\*) At nominal voltage and room temperature.

Designed to quickly fill or when reversed, drain a ballast tank at a rate of more than 45 L/min (12 GPM). Capable of pumping fresh or sea water the pump's robust design can handle the rigor of continuous duty usage, is reversible, and has a built in thermal overload for added protection. Care not to run dry forextended periods of time will increase the pump longevity and ensure reliable performance for many years. Note! Only for waterhandling.

**Item Code 66-10-24690-01** Ultra Ballast pump, 12V

**Item Code 66-10-24690-02** Ultra Ballast pump, 24V

### Ultra Ballast Pump F4B-11



For Ultra Ballast pump F4B-11

**Item Code 66-09-47196**

### Polarity Reversing Switch Kit



For convenient deckwash, includes: Pressure switch, Check valve, Trigger nozzle

**Item Code 66-09-46553**

### Deck Wash Kit for F4B-19



The vacuum switch works with all self-priming impeller pumps and should be used for e.g. bilge pumping/emptying of tanks to prevent the pump from dry running. The vacuum switch automatically shuts the pump off when the bilge/tank is dry. With the switch fitted, you can start the pump by remote push button or by depressing the lever on the switch.

In combination with electro magnetic clutch. Max 16A.

**Item Code 66-09-45053**

### Vacuum Switch



**Item Code 486300**

Manifold with multiple connections:

13-19(2x)-22-25-28.5-32-38mm,

Drainage connection 1 1/2" outer thread.

Normally located in the lowest part of the bilge.

### Universal Grey-Water-Manifold





### Macerator Pump

TA3P10-19 Waste Pump 12/24V  
 Pump Body: Phenol Plastic (PF)  
 Impeller: 66-09-1052S-9 (nitrile)  
 Housing: Thermoplastic Polyester (PET)  
 Shaft: Stainless Steel  
 Seal: Lip Seal  
 Hose connections: In 38mm (1½"), Out 25mm (1")  
 Motor: 12V-14A, 24V-7A  
 Dims.: 230 x 108 x 82mm (l x w x h)  
 Weight: 1,9kg  
 Capacity: 37l/min (at 0.2 bar)

**Item Code 66-10-24453-04** 12 V  
**Item Code 66-10-24453-05** 24 V



### Multiple Port Shower Sump

The shower sump turns on/off automatically and has multiple inlet ports for handling waste water from more than one tapping point. Equipped with a check valve on the outlet thus avoiding water coming back into the tank. The tank has a tight-fitting lid to minimize splashing and odour. The system includes a strainer that can be cleaned easily and the "Ultima"- switch.

Capacity, straight: 61l/min  
 Capacity 1,0m head: 53l/min  
 Motor: 12V or 24V  
 Current draw/Fuse: 3.4A/5A or 2A/3A  
 Intake connections: 1 x 3/4", 1 x 3/4" or 1 x 1" or 1 x 1-1/8" or 1 x 1-1/2"  
 Discharge connection: 3/4" (19mm)  
 Dims.: 273 x 210 x 135mm (l x w x h)  
 Weight: 1,05kg

**Item C. 66-32-57151-01** 12V  
**Item C. 66-32-57151-02** 24V

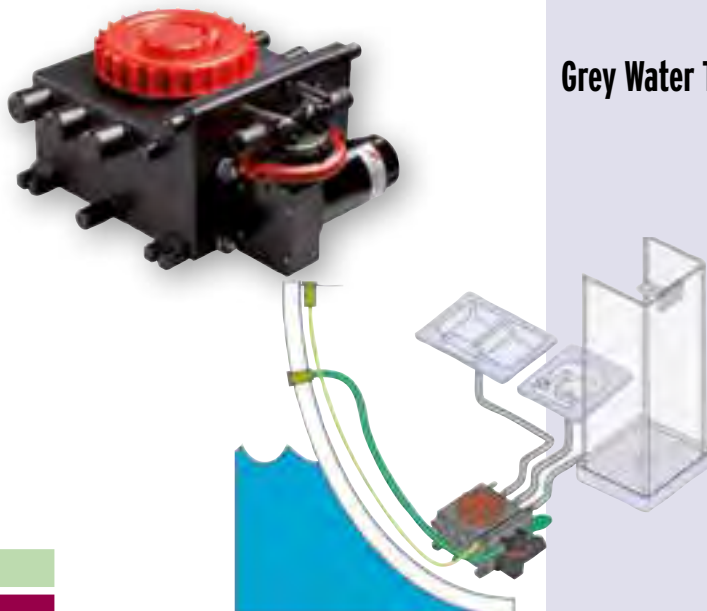

### Grey Water Tank

The Grey water tank is designed to be used as collection tank for waste water from showers, sinks, dishwashing machines, etc with 19mm, 25mm and 38mm inlet ports, and 19mm and 25mm outlet ports. The tank includes an Ultima Switch for automatic operation and is easy to connect to any 12V/24V pump up to 20 amp.

The tank is prepared for Viking Power 16, with pre-drilled holes for the pump. Dims.: 185 x 280 x 340mm

**Item Code 66-09-13384**

Grey Water Tank (Viking power 16 Pump not included)

An ultramodern, single-chamber, self-priming diaphragm pump that can be set up in several different pump/motor configurations. It is easy to install anywhere after the drain outlet in the wastewater system or as a bilge pump in any leisure craft - new or used. Its non-choke valves mean that no in-line filters are necessary, and the pump can not only run dry, it can also handle a mixture of air and water without difficulty. The Viking Power 16 is self-priming up to a height of 3 meters. With its low pulse and muffled rubber bracket, this pump offers quiet operation. Specifically designed to pump wastewater, the Viking Power 16 has been built to last, and engineered for easy maintenance. When the time comes to replace the premium grade reinforced nitrile rubber diaphragm, you can put in a spare without even removing the pump from the system.

Capacity:	19l/min, 16l/min at 1m head
Max. Head:	3m
Max. Lift:	3m
Max. Head & Lift:	4m
Motor:	40W at 1m head
Hose connections:	1" or 3/4" (19 und 25mm) hose & 1/2" BSP
Dims.:	L = 186mm - W = 235 / 181mm - H = 118 / 204mm
Weight:	2,6kg
Body:	Nylon, glass-fibre reinforced
Valves:	Nitrile rubber
Diaphragm:	Reinforced nitrile rubber

**Item Code 66-10-13350-03** Viking Power 16 12V  
**Item Code 66-10-13350-04** Viking Power 16 24V



### Viking Power 16 - Bilge, Waste and Toilet Handling

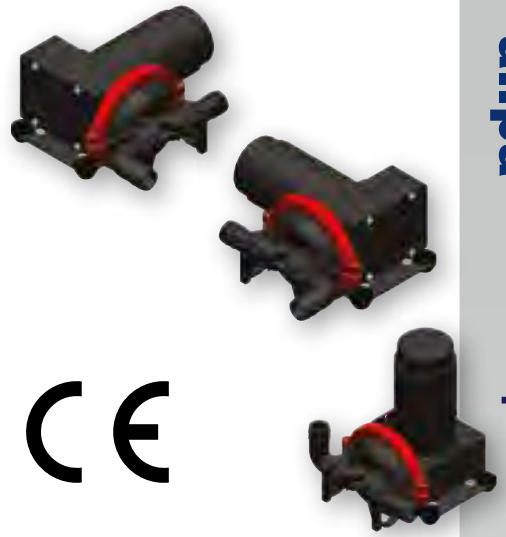

➤ **Johnson Pump®**



The Viking Power 32 and Viking Power Vacuum diaphragm pumps have been designed to meet the rigorous demands of the world's leading manufacturers of boats, recreational vehicles and busses. Thanks to its single-chamber design and non-choke valves, the Viking Power 32, can be used to pump un-accelerated sewage to a holding tank or transfer it onwards to a septic tank. The Viking Power Vacuum has double check-valves and can therefore also be used in vacuum toilet systems.

**Features:**

- Maximum flow 32l/min
- Specifically engineered to pump black wastewater
- Uncompromising odor-prevention features
- Whisper quiet operation
- Self-priming
- High-impact glass-fiber reinforced nylon body
- Ball-bearing supported transmission
- Non-choke valves - no waste shredding required
- Pump head rotatable 360°
- Double check valves on Viking Power Vacuum
- Self-priming up to 2.5 meters (8.2ft)
- Can be run dry and can pump air/water mixture
- Robust single diaphragm
- Electric motor with power-out, manual-crank backup
- Complies with ISO 15083 and small craft bilge pump standard for vessels above 12 m (39.4ft)

**Technical specifications:**

- Capacity: 32 l/min open flow
- 30 l/min at 0.1 bar
- Max head: 4 m (13.1 ft)
- Max lift: VP-32: 2.5 m (8.2 ft) VP-Vacuum: 5 m (11.5ft)
- Dims. VP-32: 277 x 264 x 192mm (L x w x h)
- Dims. VP-Vacuum: 357 x 271 x 192mm (L x w x h)
- Ports: 38mm diameter (1 1/2")
- Weight: VP-32: 5.0kg VP-Vacuum: 5.1kg
- Motor: 3.5 amp (12V), 1.8A (24V) at 0.1 bar
- 12/24V DC (with built-in thermal protection)
- Body: Nylon
- Valves: Nitrile rubber
- Diaphragm: Reinforced nitrile rubber

**Item Code 66-10-13373-03** Viking Power 32 12V  
**Item Code 66-10-13373-04** Viking Power 32 24V  
**Item Code 66-10-13373-07** Viking Power Vacuum 12V  
**Item Code 66-10-13373-08** Viking Power Vacuum 24V

CE marked according to following standards:  
 Recreational Craft Directive 94/25/EEC • ISO8846: Small Craft - Electrical devices - Protection against ignition of surrounding flammable gases.  
 ISO10133: Small Craft - Electrical systems - Extra low voltage DC- installations. ISO8849: Small Craft - Electrically operated bilge pumps. Electromagnetic Compatibility Directive 89/336/EEC  
 EN55014: 1993/Radio disturbance

### Viking Power 32 & Viking Power Vacuum Compact toilet handling and waste water pump



*It can be  
so beautiful . . .*



**allpa**  
marine equipment

- Pump body: PPA thermoplastic
- Impeller: PPS thermoplastic
- O-ring: EPDM
- Shaft: Stainless steel
- Magnet housing: PSU
- Motor: 12/24 V DC enclosed (as per IP67) permanent magnet, ball bearing mounted motor, designed for continuous operation
- Liquid temp.: Min -40°C Max +100°C
- Hose connection: Ø16mm (5/8") or 20mm (3/4") hose.
- Dims CM10 & CM30: 177 x 68 x 85mm (l x w x h)
- Weight CM10: 0.53kg & CM30: 0.6kg



### CM10 & CM30 Circulation Pump

#### Ø16mm Hose Connection:

**Item Code 66-10-24501-03 CM10P7-1 12V**, 15l/min at 0.1 bar

**Item Code 66-10-24501-04 CM10P7-1 24V**, 15l/min at 0.1 bar

#### Ø20mm Hose Connection:

**Item Code 66-10-24502-03 CM10P7-112V**, 18.5l/min at 0.1 bar

**Item Code 66-10-24502-04 CM10P7-124V**, 18.5l/min at 0.1 bar

**Item Code 66-10-24504-03 CM30P7-1 12V**, 26l/min at 0.1 bar

**Item Code 66-10-24504-04 CM30P7-1 24V**, 26l/min at 0.1 bar

CM10P7-1 16mm (5/8")

Bar	kPa	ft	l/min	USGPM	12 V	24 V
0.1	10	3.3	15.0	4.0	1.2	0.6
0.15	15	4.9	12.0	3.2	1.1	0.55
0.2	20	6.7	7.3	1.9	0.9	0.5
Fuse required					1.6A	0.8A

CM10P7-1 20mm (3/4")

Bar	kPa	ft	l/min	USGPM	12 V	24 V
0.1	10	3.3	18.5	5.0	1.2	0.6
0.15	15	4.9	14.5	3.9	1.1	0.55
0.2	20	6.7	9.0	2.4	1.0	0.5
Fuse required					1.8A	0.8A

CM30P7-1 20mm (3/4")

Bar	kPa	ft	l/min	USGPM	12 V	24 V
0.1	10	3.3	26.0	6.9	2.2	1.1
0.2	20	6.6	19.5	5.2	2.0	1.0
0.3	30	9.8	9.5	2.6	1.7	0.75
Fuse required					3.0	1.6

- Pump body: PA66 thermoplastic
- Impeller: PA66 thermoplastic
- Shaft: Stainless steel
- Shaft seal: Mechanical seal
- Motor: 12/24V DC enclosed (as per IP31) permanent magnet, ball bearing mounted motor, designed for continuous operation
- Liquid temp.: Min -30°C Max +100°C
- Hose connection: Ø38mm (1.1/2") hose
- Dims.: 211 x 117 x 110mm (l x w x h)  
Height incl. base plate 116mm
- Weight: 1.75kg

**Item Code 66-10-24190-1 C090 12V**, 100l/min at 0.1 bar

**Item Code 66-10-24190-2 C090 24V**, 100l/min at 0.1 bar

C090P5-1



### C090 Circulation Pump

C090P5-1 38mm (1 1/2")

Bar	kPa	ft	l/min	USGPM	12 V	24 V
0.1	10	3.4	100.0	26.4	7.4	4.3
0.2	20	6.7	78.2	20.7	7.3	4.2
0.3	30	10.1	56.6	14.7	7.0	3.9
0.4	40	13.4	32.0	8.5	6.5	3.5
0.5	50	16.8	7.1	1.9	5.9	3.0
Fuse required					10.0	6.0

Extra Heavy Duty Circulation Pump with a Motor service life of more than 20,000 hours & 40,000 start/stops at nominal voltage and 30°C surrounding temperature. Interchangeable motor can run dry for 30min.

- Specifically engineered for continuous duty.
- Seal-less magnetic drive. Ball bearing brushless motor. Enclosure IP67.
- Capacity: 55l/min with Ø20mm ports or 115l/min. with Ø38mm ports @0,1bar.
- System pressure -0.2 to +2.5bar @ 100°C.
- Motor voltage 13.6V DC for use between 10-16V / 27.2V DC for use between 20-32V.
- Fuse 12A (13.6V) - 6A (27.2V).
- Input power: max 125W. Weight: 3kg, including mounting bracket.

**Item Code 66-10-24898-01 CM90P7-1 BL 12V**, ports Ø38mm (1-1/2")

**Item Code 66-10-24898-02 CM90P7-1 BL 24V**, ports Ø38mm (1-1/2")

**Item Code 66-10-24901-01 CM90P7-1 BL 12V**, ports Ø20mm (3/4")

**Item Code 66-10-24901-02 CM90P7-1 BL 24V**, ports Ø20mm (3/4")

Protection against ignition of surrounding flammable gases et cetera.

CE-certified: 94/25EEC: SIO 8846. ISO 10133.

### Johnson Pump®

### Extra Heavy Duty Circulation Pump



CE-certified: 94/25 EEC: ISO 8846. ISO 10133.

#### Features:

- Capacity: 90 l/min at 0.25 bar
- System pressure: -0.3 to +3.0 bar; stationary max. 4.0 bar
- Liquid: water/glycol mixture; max. 60% glycol
- Motor service life: More than 5,000 hours at nominal voltage 10,000 start/stops. Interchangeable motor.
- Motor, voltage: Nominal 13.6V DC for use between 10-16V
- Nominal 27.2V DC for use between 20-32V
- Input power: Max. 125W
- Dry running: 30 minutes
- Dimensions: 244 x 120 x 150mm (l x w x h)
- Ports: Ø38mm (1 1/2")
- Weight: 3.0kg
- Body: PPA, glass-fiber reinforced
- Mounting: Separate universal bracket for flat surfaces

**Item Code 66-10-24664-01 CM90** 12V

**Item Code 66-10-24664-02 CM90** 24V

### Johnson Pump®

### Circulation Pump CM90





### IDREX S15

**Item Code 086001** S15-12V

**Item Code 086002** S15-24V

#### Capacity

Head(m) 0 2 4 6 8 10

Litre 18 16 15 14 13 12

**IDREX S15** 18,5l/min.

Self priming diaphragm Deck wash & Refuelling Pump Can run dry without damage. Available in 12V & 24V For Specifications see Page 493.



### IDREX S40

**Item Code 086005** S40-12V

**Item Code 086006** S40-24V

**Item Code 086007** S40-230V

#### Capacity

Head(m) 0 2 4 6 8 10

Litre 37 34 31 28 27 27

**IDREX S40** 37,0l/min.

Self priming diaphragm Deck wash & Refuelling Pump Can run dry without damage. Available in 12V, 24V & 230V For specifications see Page 493.



### PVM 0,2

**Item Code 086010** PVM 0,2 -12V

**Item Code 086011** PVM 0,2 -24V

**Item Code 086012** PVM 0,2 -230V

**Item Code 086013** PVM 0,2 -400V

**PVM 0,2** 30,0l/min.

Self priming diaphragm pump. PVC Body Can run dry without damage Suitable for seawater, drinking-water, waste water, diesel and liquid food etc. Available in 12V, 24V, 230V & 380V. For specifications see Page 493.

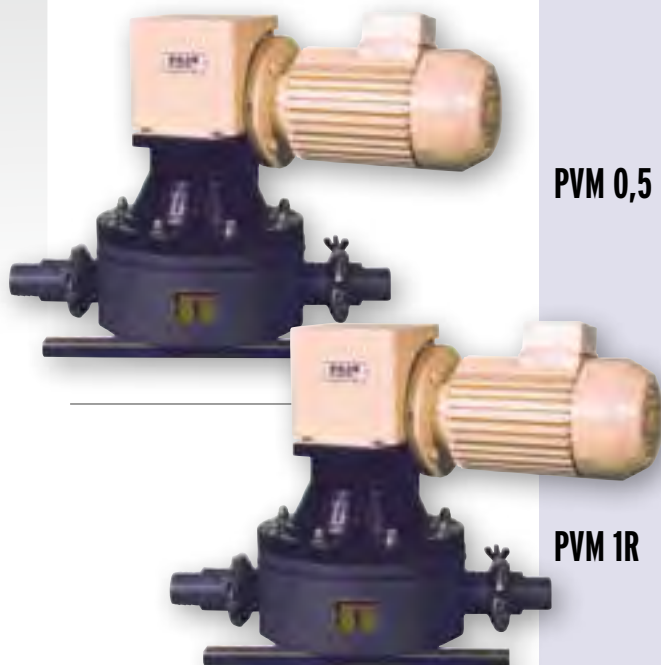

### PVM 0,5

**Item Code 086015** PVM 0,5 -12V

**Item Code 086016** PVM 0,5 -24V

**Item Code 086017** PVM 0,5 -230V

**Item Code 086018** PVM 0,5 -400V

**PVM 0,5** 70,0l/min.

Self priming diaphragm pump. PVC Body Can run dry without damage Suitable for seawater, drinking-water, waste water, diesel and liquid food etc. Available in 12V, 24V, 230V & 380V. For specifications see Page 493.



### PVM 1R

**Item Code 086025** PVM 1R-24V

**Item Code 086026** PVM 1R-230V

**PVM 1R** 100,0l/min.

Self priming diaphragm pump. PVC Body Can run dry without damage Suitable for seawater, drinking-water, waste water, diesel and liquid food etc. Available in 24V & 230V. For specifications see Page 493.



### A66B - Centrifugal Pump

**Item Code 086030** A66B-12V

**Item Code 086031** A66B-24V

**A66B Centrifugal Pump** 17l/min. Bronze Pump Body & Bronze Impeller. Sel-Priming due to venturi system. Suitable for seawater, fresh water and gas-oil transfer. Pump body & impeller are made of bronze Available in 12V & 24V For specifications see Page 493.



**Item Code 086085**

PVM 0,16-12V

**Item Code 086086**

PVM 0,16-24V

PVM 0,16 30L/m. Extra compact self priming diaphragm pump. Can run dry without damage

Cannot clog: no impeller, seals or valves

Pumps without problems liquids and solids like sand, mud, debris, saw-dust, sediment, and hair or cotton. Suitable for seawater, drinking-water, oil, diesel, waste water and also liquid food

**Features**

- Self priming up to 3m
- Max. Head: 5m
- Pump Body of PVC
- Hose Connections: 38mm
- Weight 6kg
- Dims.: 350 x 250 x 250mm (w x d x h)
- Motor 0,35 Hp/0,26kW
- Current Draw: 6A/12V or 3A/24V

## 30L per minute!

**Technical information & dimensions pumps**

Item Code	Model	Litre/ min.	Self priming	Max. Head	Rated Motor	Amps/ breaker	Pump body	Hose connection	Weight	Dimensions L x W x H
086001	S15-12V	18,5	2,0m	10m	90W	10/16A	PVC	20mm	1,9kg	260x70x180mm
086002	S15-24V	18,5	2,0m	10m	90W	5/ 6A	PVC	20mm	1,9kg	260x70x180mm
086005	S40-12V	37,0	4,0m	8m	200W	16/20A	PVC	25mm	5,0kg	310x120x195mm
086006	S40-24V	37,0	4,0m	8m	200W	7/10A	PVC	25mm	5,0kg	310x120x195mm
086007	S40-230V	37,0	4,0m	8m	200W	1/ 2A	PVC	25mm	5,0kg	310x132x190mm
086010	PVM 0,2-12V	30,0	3,0m	5m	120W	12/16A	PVC	38mm	10,0kg	380x200x310mm
086011	PVM 0,2-24V	30,0	3,0m	5m	120W	8/10A	PVC	38mm	10,0kg	380x200x310mm
086012	PVM 0,2-230V	30,0	3,0m	5m	260W	2,3/3A	PVC	38mm	10,0kg	380x200x310mm
086013	PVM 0,2-400V	30,0	3,0m	5m	260W	1/2A	PVC	38mm	10,0kg	380x200x310mm
086015	PVM 0,5-12V	70,0	3,0m	5m	370W	45/50A	PVC	38mm	18,0kg	480x250x370mm
086016	PVM 0,5-24V	70,0	3,0m	5m	370W	22/25A	PVC	38mm	18,0kg	480x250x370mm
086017	PVM 0,5-230V	70,0	3,0m	5m	370W	3,2/ 4A	PVC	38mm	18,0kg	480x250x370mm
086018	PVM 0,5-400V	70,0	3,0m	5m	370W	1,3/ 2A	PVC	38mm	18,0kg	480x250x370mm
086025	PVM 1R-24V	100,0	4,0m	4m	350W	22/25A	PVC	38mm	25,0kg	560x350x350mm
086026	PVM 1R-230V	100,0	4,0m	4m	350W	3,2/ 4A	PVC	38mm	25,0kg	560x350x350mm
086030	A66B-12V	17,0	5,5m	18m	185W	15/16A	Bronze	20mm	4,7kg	270x130x130mm
086031	A66B-24V	17,0	5,5m	18m	185W	9/10A	Bronze	20mm	4,7kg	270x130x130mm
086085	PVM 0,16-12V	30,0	3m	5m	260W	6/8A	PVC	38mm	6,0kg	350x250x250mm
086086	PVM 0,16-24V	30,0	3m	5m	260W	3/4A	PVC	38mm	6,0kg	350x250x250mm

PVM 0,16



Johnson Pump®



Extra Heavy Duty Impeller Pump

Whenever you need greater strength or service from a pump, use an extra heavy duty flexible impeller pump with separate bearing housing and mechanical seal for less wear and longer life.

These pumps cover the entire range of marine applications and may be used as cooling water pumps, bilge pumps, deck wash pumps, emergency and fire fighting pumps, etc.

Available in sizes from 3/4" to 2 1/2" (13l/min to 625l/min).

Wearing parts are easily replaceable and service kits are available for all standard models.

Vacuum switch is available as extra accessory.

Technical specifications:

- Pedestal cast iron with permanently lubricated double ball bearings.
- Connection BSP or NPTF
- Pump body: bronze with connection for vacuum switch
- Shaft: stainless steel
- Seal: mechanical
- Cam: Full or reduced

Item Code	Model	Impeller	Connection	Length	Width	Height	Weight	Shaft Ø
66-10-24210-1	F5B 3000	66 09 1027B / B 9	3/4" BSP	195mm	106mm	88mm	2,9kg	17mm
66-10-24209-1	F7B 3000	66 09 1028B / B 9	1" BSP	213mm	120mm	93mm	3,1kg	17mm
66-10-13024-1	F8B 3000VF	66 09 819B / B 9	1 1/2" BSP	255mm	152mm	154mm	7,6kg	24mm
66-10-13026-1	F9B 3000	66 09 802B /814B 9	2" BSP	282mm	192mm	157mm	9,3kg	24mm
66-10-13175-01	F8B 3000 TSS	66 09 819B / B 9	1 1/2" BSP	255mm	198mm	151mm	7,6kg	24mm
66-10-13225-01	F9B 3000 VF	66 09 802B / 814B 9	2" BSP	282mm	152mm	175mm	9,3kg	24mm
66-10-13177-01	F9B 3000 TSS	66 09 802B /814B 9	2" BSP	282mm	200mm	151mm	9,3kg	24mm
66-10-13121-01	F95B 3000	66 09 820B	2 1/2" BSP	354mm	295mm	201mm	17,2kg	24mm

Johnson Pump®



Impeller

Item Code 66-09-703P-1 Impeller replaces Mercruiser 47-59362T

Item Code 66-09-701B-1 Impeller replaces Sherwood 09959K

Item Code 66-09-702B-1 Impeller replaces Sherwood 10615K

Item Code 66-09-704BT-1 Impeller replaces Sherwood 17000K

We can now offer a new impeller stand that can rotate and has room for 10 of our most popular spare impellers up to size F7 Display

size: Height 750mm incl. top sign. Width 500mm

Included are:

- Impeller guide with 1/1 size illustration of all our impellers
- 5 pcs 66-09-806B-1
- 5 pcs 66-09-808B-1
- 5 pcs 66-09-810B-1
- 5 pcs 66-09-1026B-1
- 5 pcs 66-09-801B
- 5 pcs 66-09-1027B-1
- 5 pcs 66-09-1028B
- 5 pcs 66-09-1052S-9
- 5 pcs 66-09-1077B-9
- 5 pcs 66-09-824P-9

Item Code 66-09-46854

Complete stand including above impellers.

**Note: Price of this Impeller Bar including impellers is less than the total price of all these impellers if ordered separately without display!**



Johnson Pump Impeller Bar



## Heavy Duty Impeller Pumps

A range of multipurpose bronze pumps. Compact design, raw water Resistant pumps at an attractive price – with the renowned Johnson Pump quality. With excellent self-priming capability, these pumps are ideal as cooling water pumps for marine engines, bilge pumps, deck-wash pumps, fresh water pumps, fuel transfer pumps and to empty septic tanks.

## Johnson Pump®

Pump body:	Bronze
Impeller:	<b>66-09-808B-1</b> (MC-97)
Shaft:	Stainless steel, with double ball bearings
Seal:	Mechanical seal.
Connection:	3/8" BSP
Capacity:	20,5l/min
Dimensions	109 x 80 x 30mm (L x w x h)
Weight:	0.5kg
Drive shaft	Ø12k6mm
<b>Item Code</b>	<b>66-10-24569-01</b>
	Mechanical seal, full cam, S/S end cover, wear plate On request: Reduced cam

### Self-Priming All-Round Flexible Impeller Bronze Pedestal Pumps



### F35B-8 3/8"



Pump body:	Bronze
Impeller:	<b>66-09-810B-1</b> (MC-97) / <b>66-09-810B-9</b> (nitrile) optional
Shaft:	Stainless steel, with double ball bearings
Seal:	Mechanical seal
Connection:	3/8" BSP
Capacity:	34,5l/min
Dimensions	111 x 80 x 50mm (L x w x h)
Weight:	0.8kg
Drive shaft	Ø12k6mm
<b>Item Code</b>	<b>66-10-24570-01</b>
	Mechanical seal, full cam, S/S end cover, wear plate On request: Reduced cam

### F4B-8 3/8"



Pump body:	Bronze
Impeller:	<b>66-09-1027B-1</b> (MC-97) / <b>66-09-1027-9</b> (nitrile) optional
Shaft:	Stainless steel, with double ball bearings
Seal:	Mechanical seal
Connection:	3/4" BSP
Capacity:	46,0l/min
Dimensions	151 x 106 x 50mm (L x w x h)
Weight:	1.6kg
Drive shaft	Ø17k6mm
<b>Item Code</b>	<b>66-10-24571-01</b>
	Mechanical seal, full cam, S/S end cover, wear plate. On request: Reduced cam

### F5B-8 3/4"



Pump body:	Bronze
Impeller:	<b>66-09-1028B</b> (neoprene)
Shaft:	Stainless steel, with double ball bearings
Seal:	Mechanical seal
Connection:	1" BSP
Capacity:	107l/min
Dimensions	170 x 120 x 50mm (L x w x h)
Weight:	1.9kg
Drive shaft	Ø17k6mm
<b>Item Code</b>	<b>66-10-24572-01</b>
	Mechanical seal, full cam, S/S end cover, wear plate. On request: Reduced cam

### F7B-8 1"



Pump body:	Bronze
Impeller:	<b>66-09-819B</b> / <b>66-09-819B-9</b> (nitrile) optional
Shaft:	Stainless steel, with double ball bearings
Seal:	Mechanical seal
Connection:	1 1/2" BSP
Capacity:	279l/min
Dimensions	217 x 160 x 65mm (L x w x h)
Weight:	5.9kg
Drive shaft	Ø24h8mm
<b>Item Code</b>	<b>66-10-13021-1</b>
	Mechanical seal, full cam, wear plate On request: Reduced cam

### F8B-8 1 1/2"



Set bronze butterfly nuts and studs for quick impeller replacement. Very convenient when the standard end cover screws are hard to reach with a screw driver

<b>Item Code</b>	<b>66-95093-50</b>	Pinwing Set-A	Johnson Pump	6st. 8/32xM4
<b>Item Code</b>	<b>66-95093-51</b>	Pinwing Set-B	Johnson F35B	4st. M4 x M4
<b>Item Code</b>	<b>66-95093-52</b>	Pinwing Set-C	Johnson F4/F5B	6st. M4 x M4
<b>Item Code</b>	<b>66-95093-54</b>	Pinwing Set-E	Johnson F7B	6st. M5 x M5
<b>Item Code</b>	<b>66-95093-55</b>	Pinwing Set-F	Johnson Pump	4st. M5 x M5
<b>Item Code</b>	<b>66-95093-56</b>	Pinwing Set-G	Johnson Pump	6st. 10/32 x M5
<b>Item Code</b>	<b>66-95093-57</b>	Pinwing Set-H	Johnson Pump	6st. M8 x M6

### Bronze "Pin Wing" Kit

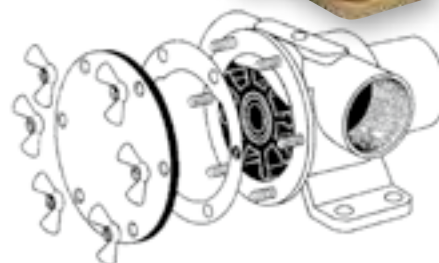

## Replacement Cooling Pumps



Pump	OEM No.	Supplier	Engine Description	Item Code
F7B-9 IMPELLER PUMP OEM (DEUTZ)	4229524	Deutz	D7	66102458011
F7B-9 IMPELLER PUMP OEM		Drinkwaard Motoren	OM 616/617	6610241271
F4B-9 IMPELLER PUMP OEM 1/1 (Fischer Panda)	0030105	Fischer Panda	Panda 12 000 NE PMS Kubota, Panda 6000 ND PMS Kubota, Panda 8000 NE PMS Kubota, Panda 9000 ND PMS Kubota	66102496702
F7B-9 IMPELLER PUMP OEM	RE525563	John Deere	Deere S350	66101359902
F7B-9 IMPELLER PUMP OEM	RE535944	John Deere	Deere S350, PowerTech 4.5L, 4045DFM70/TFM75, Powertech 6.8L, 6068TFM75/TFM76	66101359902
F7B-9 IMPELLER PUMP OEM	DZ107518	John Deere	Deere S350	66101359902
F7B-9 IMPELLER PUMP OEM	DZ116559	John Deere	Deere S350	66101359902
F7B-9 IMPELLER PUMP OEM		KOHLER	GM57562	66101359902
F7B-903 IMPELLER PUMP OEM		Lombardini	LDW 2204 MD	66102447502
F4B-9 IMPELLER PUMP OEM		Lombardini	LDW 1003 M, LDW 1204 M, LDW 1404 M, LDW 502 M, LDW 602 M, LDW 702 M, LDW 903 M	6610350984
F4B-9 IMPELLER PUMP OEM		Lombardini	LDW 1503 M, LDW 1603 M, LDW 2004 M, LDW 2204 M	66103535501
F9B-905 IMPELLER PUMP OEM (MHI)	33A53-15100	Mitsubishi	S6M3	66101317111
F5B-9 IMPELLER PUMP OEM	970301725	Nanni Diesel	N3.30, N4.38, N4.40	66102433401
F5B-9 IMPELLER PUMP OEM		Nanni Diesel	3.110 HE, 4.110 HE, 4.190 HE, 4.150 HE	66102433401
F7B-9 IMPELLER PUMP (NANNI)	970316374	Nanni Diesel	N4.65, N4.80, GENSETS V3300	66102490411
F7B-9 IMPELLER PUMP (NANNI)	970316373	Nanni Diesel	N4.115, N4.140	66102490412
F4B-9 IMPELLER PUMP OEM 1/1 (Thread)	538.012.1	Nanni Diesel	2.60, 3.90, 2.60 HE, 3.90 HE, P 30	66102494901
F35B-9 IMPELLER PUMP OEM	970300495	Nanni Diesel	2.40H & 2.60H	6610352113
F4B-9 IMPELLER PUMP OEM	970307808	Nanni Diesel	N2.10, N2.14, N3.21	66103572501
F4B-9 IMPELLER PUMP OEM		Nanni Diesel	2.50 HE, 3.75 HE	66103572501
F7B-903 IMPELLER PUMP OEM		Nanni Diesel	5250 TDi	66102490411
F5B-9 IMPELLER PUMP OEM (VP3583089)	3583089	Perkins	D2-55, D2-75	66101328311
F7B-9 IMPELLER PUMP OEM		Perkins	6.305/6.354 6 cyl;6.3543M;6HD 135/15D;	6610240141
F5B-9002 IMPELLER PUMP OEM		Perkins	4.99M, 4.108 4 cyl, 4.107MLL	6610241192
F7B-9 IMPELLER PUMP OEM		Steyr	All 4 Cyl./ 6Cyl. from 1999	66102463701
F7B-903 IMPELLER PUMP OEM	STM8020	Vetus	P 4.25	6610242181
F5B-9 IMPELLER PUMP OEM	STM8000	Vetus	42-26-21, 52-34-26, 42-26-26, 36-22-11, M 4.14, 52-34-21	6610351001
F4B-9 IMPELLER PUMP OEM	STM8050	Vetus	K 3/3D/4	6610351611
F4B-9 IMPELLER PUMP OEM		Vetus	K 3/3D/4	6610351611
F7B-9 IMPELLER PUMP OEM	STM 8922	Vetus	DT(A) 44/44	66102463004
F7B-9 IMPELLER PUMP OEM		Vetus	DT(A) 64/66/67	66102463003
F7B-9 IMPELLER PUMP OEM		Vetus	VF4 VF5	6610241271
F9B-905 IMPELLER PUMP OEM		Yanmar	6 SY-STP, 8SY-STP	66102430812
F4B-903 IMPELLER PUMP OEM (VP3593654)	3593654	Volvo Penta	D1-13, D1-20, D1-30,	66102475111
F4B-9 IMPELLER PUMP OEM (VP3593655)	3593655	Volvo Penta	D1-30, D2-40	66102475211
F5B-9 IMPELLER PUMP OEM (VP3583089)	3583089	Volvo Penta	D2-55, D2-75	66101328311
F6B-9 IMPELLER PUMP OEM (VP3593656)	3593656	Volvo Penta	D3	66101344911
F6B-9 IMPELLER PUMP OEM (VP21141637)	21141637	Volvo Penta	D3	66101344901
F6B-9 IMPELLER PUMP OEM (VP3884694)	3884694	Volvo Penta	D3	66101344911

Pump	OEM No.	Supplier	Engine Description	Item Code
F5B-9 IMPELLER PUMP OEM (VP)		Volvo Penta	AQ 170C, AQ 171A/C, AQ 175A, AQD 21A, AQD 21B, BB 140A, BB 145A, BB 165A, BB 170A/B, BB 170C, MD 21A, MD 21B, MD 42A	6610320581
F4B-9 IMPELLER PUMP OEM (VP829895)	829895	Volvo Penta	AQ115A;AQ115A;AQ115B;AQ130A;AQ130B;AQ130C;AQ130D;BB115A;BB115B;BB115C;MB20A;MB20B;MB20C;MD17C;MD17D;MD3B;	6610350983
F5B-9 IMPELLER PUMP OEM	855517	Volvo Penta	AQ171A, AQ171C, 251A	6610326212
F5B-902 IMPELLER PUMP OEM	855578	Volvo Penta	230A, 230B, 250A, 250B, AQ120B, AQ125A, AQ140A, BB140A, AQ145A, BB145A, AQ125B, AQ145B, AQ131A, AQ131B, AQ131C, AQ131D, AQ151A, AQ151B, AQ151C	6610326213
F8B-905 IMPELLER PUMP OEM (VP838522)	838522	Volvo Penta	MD40A, TMD40A, TMD40B, TMD40C, AQD40A, TAMD40A, TAMD40B, AD40B, AQAD40A, AQAD40B	6610241303
F7B-9 IMPELLER PUMP OEM (VP858469)	858469	Volvo Penta		6610242773
			MD31A, TMD31A, TMD31B, TAMD31A, TAMD31B, AD31, AQAD31A, AD31B, 290A, 740, 740A, DPX, PT93, DP-A, DP-B, DP-A1, DP-B1, SP-A, SP-A1; TMD41A, TMD41B, D41A, D41B, TAMD41A, TAMD41B, AQAD41A, AD41A, AD41B, 290A, 740, 740A, DPX, PT93, DP-A, DP-B, DP-A1, DP-B1, SP-A, SP-A1, AD41BJ, AD41, AD41P-B, D41, TAMD41M-A, AD 31A/B, AD 41A/B, AQAD 30A, AQAD 31A, AQAD 40A/B, AQAD 41A, AQD 40A, AQD 41A, D 41A/B, MD 31, MD 31A, MD 40A, TAMD 31, TAMD 31A/B, TAMD 41, TAMD 41A/B, TMD 31, TMD 31A/B, TMD 40A/B/C, TMD 41A/B	
F4B-903 IMPELLER PUMP OEM (VP3580944)	3580944	Volvo Penta		66102475111
			MD2010-C, MD2010-D, MD2020-C, MD2020-D, MD2030-C, MD2030-D, MD2040-C, MD2040-D, 120S-D, 120S-E, MD2010B, MD2020B, MD2030B, MD2040B, MS2L-D, MS2A-D, 120S-D, MS2B-R, MS2A-E, MS2L-E, D1-13, D1-13B, D1-20, D1-20B, D1-30, D1-30B, D2-40, D2-40B, D1-13F, D1-20F, D1-30F, D2-40F, MD2010A, MD2020A, MD2030A, MD2040A, MS2B-R, MS2A-D, MS2A-E, MS2L-D, MS2L-E, 120S-D, 120S-E, MD2010, MD2030, MD2040, MD2020	
F4B-9 IMPELLER PUMP OEM (VP3580945)	3580945	Volvo Penta		66102475211
			MD2010-C, MD2010-D, MD2020-C, MD2020-D, MD2030-C, MD2030-D, MD2040-C, MD2040-D, 120S-D, 120S-E, MD2010B, MD2020B, MD2030B, MD2040B, MS2L-D, MS2A-D, 120S-D, MS2B-R, MS2A-E, MS2L-E, D1-13, D1-13B, D1-20, D1-20B, D1-30, D1-30B, D2-40, D2-40B, D1-13F, D1-20F, D1-30F, D2-40F, MD2010A, MD2020A, MD2030A, MD2040A, MS2B-R, MS2A-D, MS2A-E, MS2L-D, MS2L-E, 120S-D, 120S-E, MD2010, MD2030, MD2040, MD2020	
F7B-9 IMPELLER PUMP OEM (VP3583115)	3583115	Volvo Penta		66102452412
			KAD42P-A, KAMD42P-A, HS1A, KAD32P, TAMD42WJ-A, KAD43P-A, KAMD43P, KAMD43P-A, KAMD43P-B, KAD44P, KAD44P-B, KAD44P-C, KAMD44P-A, KAMD44P-C, KAD300-A, KAMD300-A, HS1A, HS1E-A, KAMD44P-BAD31L-A, AD31P-A, AD41L-A, AD41P-A, D41L-A, TAMD31L-A, TAMD31M-A, TAMD31P-A, TAMD31S-A, TAMD41H-A, TAMD41H-B, TAMD41P-A, TAMD41L-A, TAMD41M-A, TMD31L-A, TMD41L-A, TAMD31S, HS1A, TAMD31L, TAMD31P, TAMD41PMD31A, TMD31B, TAMD31B, AD31BTMD41B, D41B, TAMD41B, AD41B, AD41BJKAD42A, KAMD42A, HS1A, MS5BAD31D, AD31D-A, AD31XD, TAMD31D, TMD31DAD41D, D41D, TAMD41D, TMD41D, HS1AKAD42B, KAMD42B, TAMD42B	
F7B-9 IMPELLER PUMP OEM VP3581558	3581558	Volvo Penta	Benzine Motoren	66102452412
F5B-905 IMPELLER PUMP OEM (VP3858847)	3858847	Volvo Penta	Benzine Motoren	66101315908
F5B-9 IMPELLER PUMP OEM (VP3812693)	3812693	Volvo Penta	Benzine Motoren	66101356711
F5B-9 IMPELLER PUMP OEM (VP3812695)	3812695	Volvo Penta	Benzine Motoren	66101356713
F5B-9 IMPELLER PUMP OEM (VPoA)	3812697	Volvo Penta	Benzine Motoren	66101356811
F6B-9 IMPELLER PUMP OEM (VPoA)	3812519	Volvo Penta	Benzine Motoren	66101356911
F5B-905 IMPELLER PUMP OEM (VP3857794)	3857794	Volvo Penta	Benzine Motoren	66101315907

Item Code 66-10-24569-01	F35B-8 3/8" Capacity 20,5l/min
Item Code 66-10-24570-01	F4B-8 3/8" Capacity 34,5l/min
Item Code 66-10-24571-01	F5B-8 3/4" Capacity 46l/min
Item Code 66-10-24572-01	F7B-8 1" Capacity 107l/min

### Bronze Flexible Impeller Pedestal Pumps

► Johnson Pump®



23

## SPX Johnson Pump Original Impellers

Ref.	Pump	Impeller	Material*	Outer dia		Inner dia		Width		Replaces Jabsco No	
				mm	inch	mm	inch	mm	inch	Europe	USA
1	F2	<b>66-09-1077B-9</b>	Nitrile	35.2	1.29	8.0 / Flat	0.31 / Flat	12.7	0.50		
2	F3	<b>66-09-843S-9</b>	Nitrile	45.2	1.78	8.0 / Flat	0.31 / Flat	12.8	0.50		
3	TA3P10	<b>66-09-1052S-9</b>	Nitrile	45.2	1.78	8.0 / Flat	0.31 / Flat	12.8	0.50		
4	F35	<b>66-09-806B-1</b>	MC97	40.0	1.58	9.5	0.37	19.0	0.75		4528-0001
5	F35	<b>66-09-808B-1</b>	MC97	40.0	1.58	12.0	0.47	19.0	0.75		22405-0001
6	F4	<b>66-09-824P-1</b>	MC97	50.8	2.00	8.0 / Flat	0.31 / Flat	22.0	0.87		
6	F4	<b>66-09-824P-9</b>	Nitrile	50.8	2.00	8.0 / Flat	0.31 / Flat	22.0	0.87		6303-0003
7	F4	<b>66-09-810B-1</b>	MC97	50.8	2.00	12.0	0.47	22.0	0.87		18653-001
7	F4	<b>66-09-810B-9</b>	Nitrile	50.8	2.00	12.0	0.47	22.0	0.87		
8	F4	<b>66-09-1026B-1</b>	MC97	50.8	2.00	12.7	0.50	22.0	0.87		673-0001
8	F4	<b>66-09-1026B-9</b>	Nitrile	50.8	2.00	12.7	0.50	22.0	0.87		673-0003
9	F5	<b>66-09-801B</b>	Neoprene	57.1	2.25	15.9 / Key	0.63 / Key	31.5	1.24		4568-0001
10	F5	<b>66-09-1027B-1</b>	MC97	57.1	2.25	Splines		31.5	1.24		1210-0001
10	F5	<b>66-09-1027B-9</b>	Nitrile	57.1	2.25	Splines		31.5	1.24		1210-0003
11	F6	<b>66-09-812B-1</b>	MC97	57.1	2.25	Splines		48.2	1.90		13554-0001
12	F7	<b>66-09-1028BT-1</b>	MC97	65	2.56	Splines		50.2	1.98		17937-0001
12	F7	<b>66-09-1028B-9</b>	Nitrile	65	2.56	Splines		50.2	1.98		17937-0003
13	F75	<b>66-09-821BT-1</b>	MC97	65	2.56	Splines		80	3.15		
14	F8	<b>66-09-819B</b>	Neoprene	95	3.74	Splines		63	2.48	836-0001	17935-0001
14	F8	<b>66-09-819B-9</b>	Nitrile	95	3.74	Splines		63.2	48	836-0003	17935-0003
15	F8	<b>66-09-1029B<sup>1)</sup></b>	Neoprene	95	3.74	Splines		63.2	48	836-0001	17935-0001
16	F9	<b>66-09-802B</b>	Neoprene	95	3.74	Splines		88.5	3.48		6760-0001
17	F9	<b>66-09-814B</b>	Neoprene	95	3.74	Splines		88.5	3.48	21676-0001	17936-0001
18	F95	<b>66-09-820B</b>	Neoprene	95	3.74	Splines		130	5.12		
19	F98	<b>66-09-842B</b>	Neoprene	95	3.74	Splines		180	7.09		

\* MC97 and Neoprene for cooling, Nitrile is oil resistant      \* Alternative Impeller 09-819B

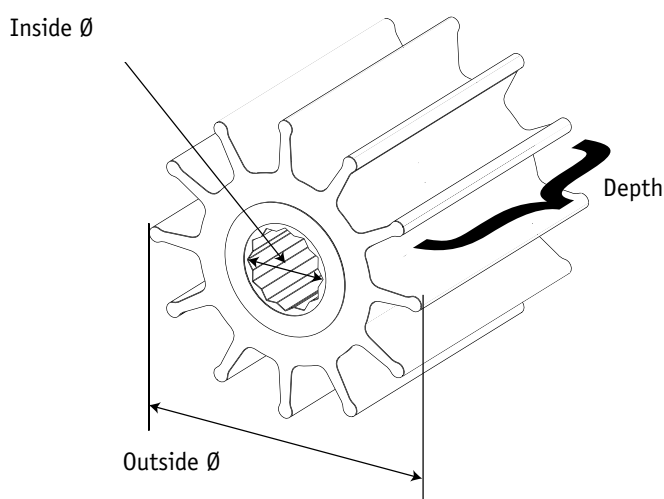

**Johnson Pump®**

## SPX Johnson Pump Original Impellers

Scale 1:1

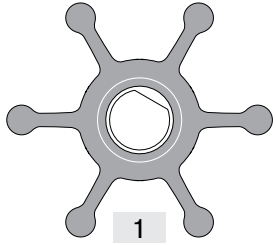

1

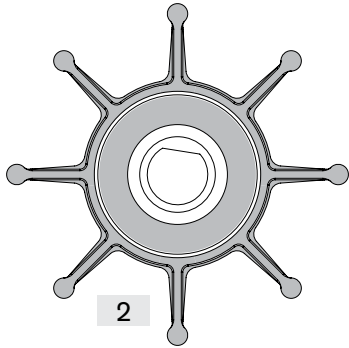

2

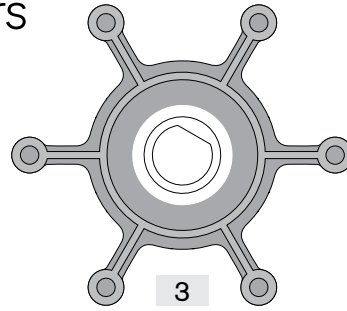

3

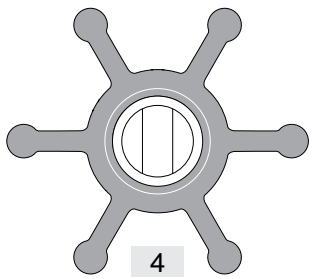

4

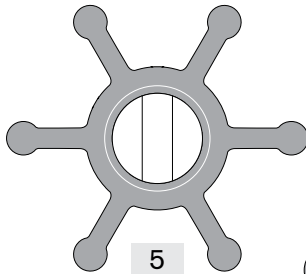

5

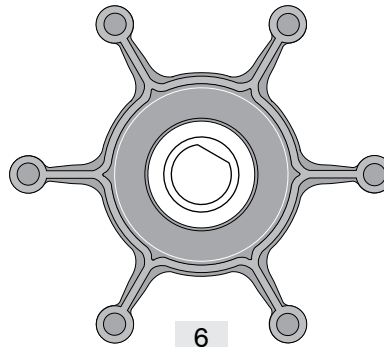

6

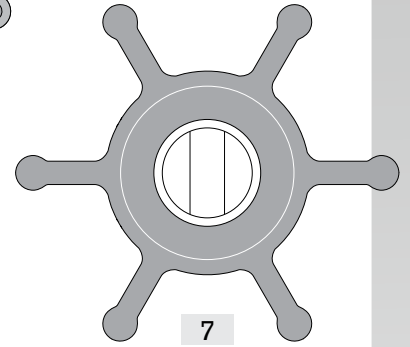

7

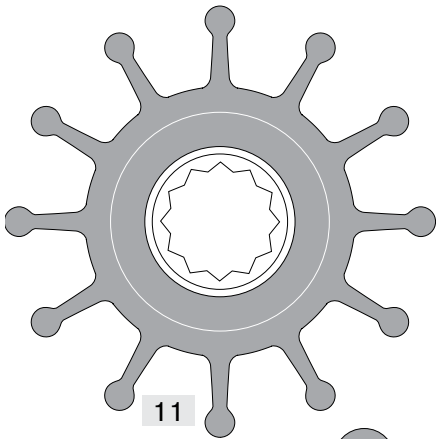

11

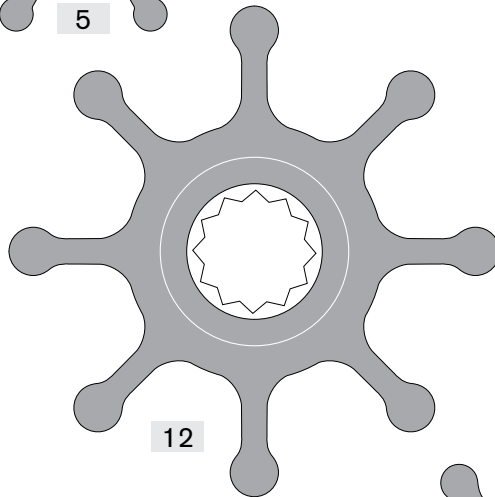

12

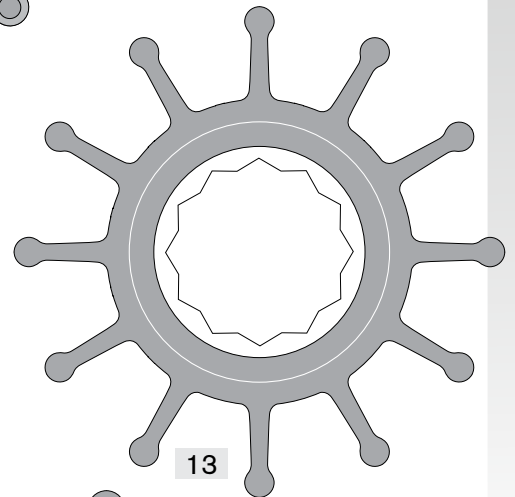

13

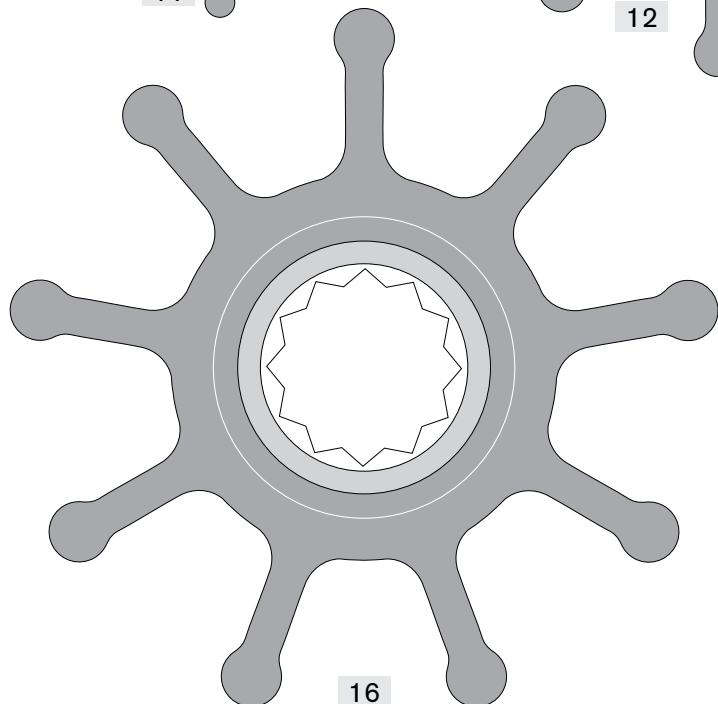

16

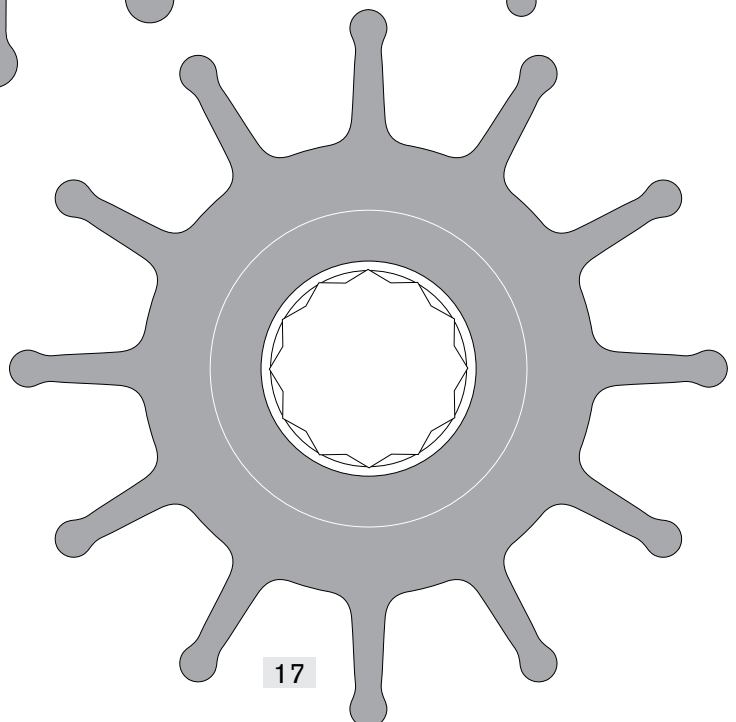

17

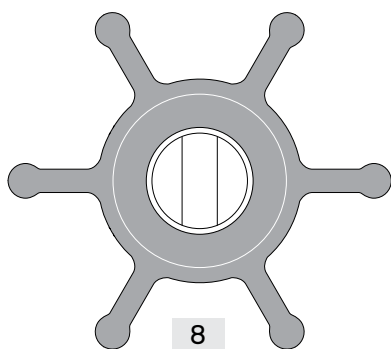

8

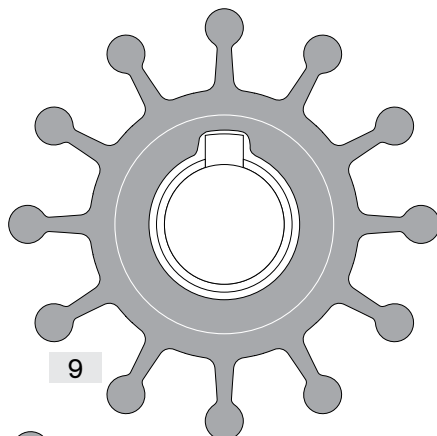

9

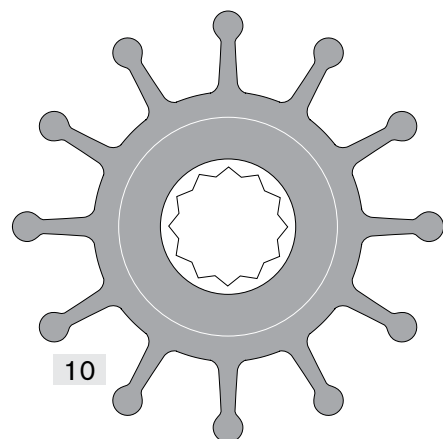

10

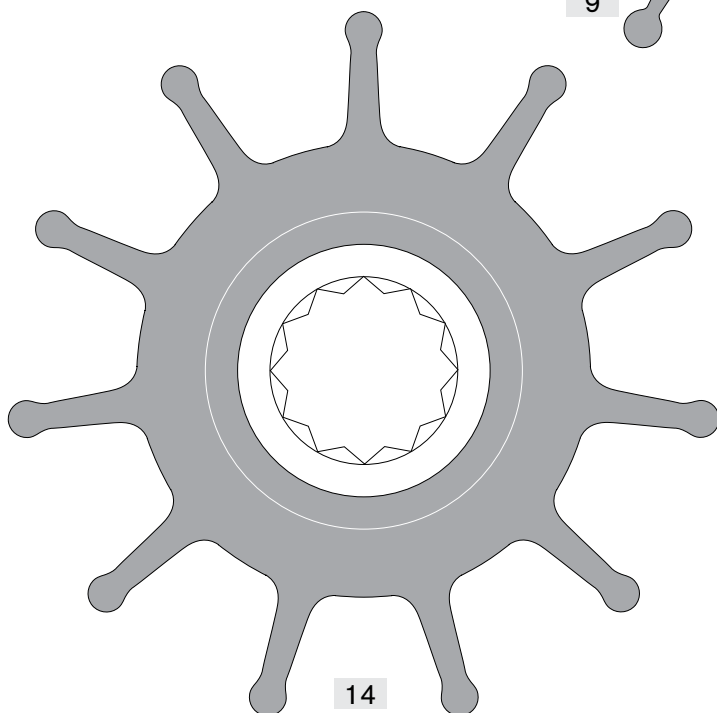

14

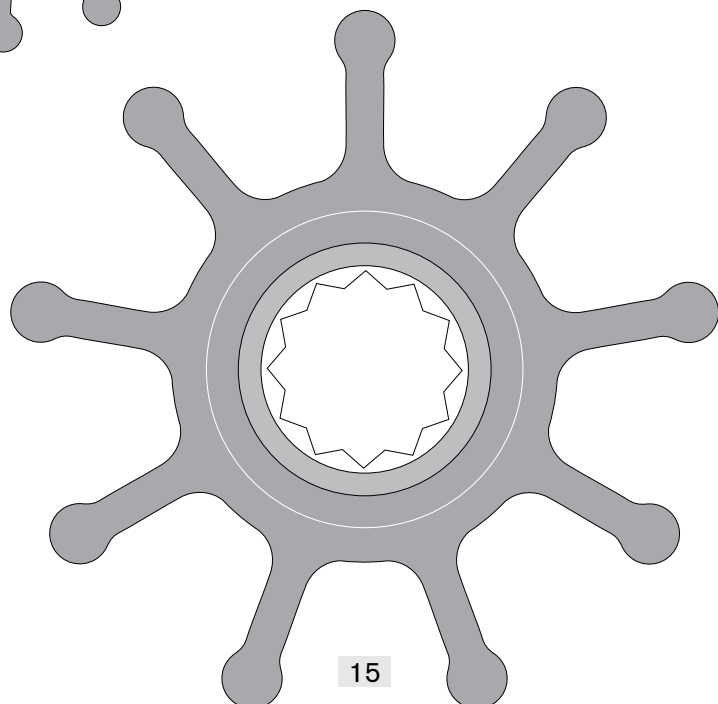

15

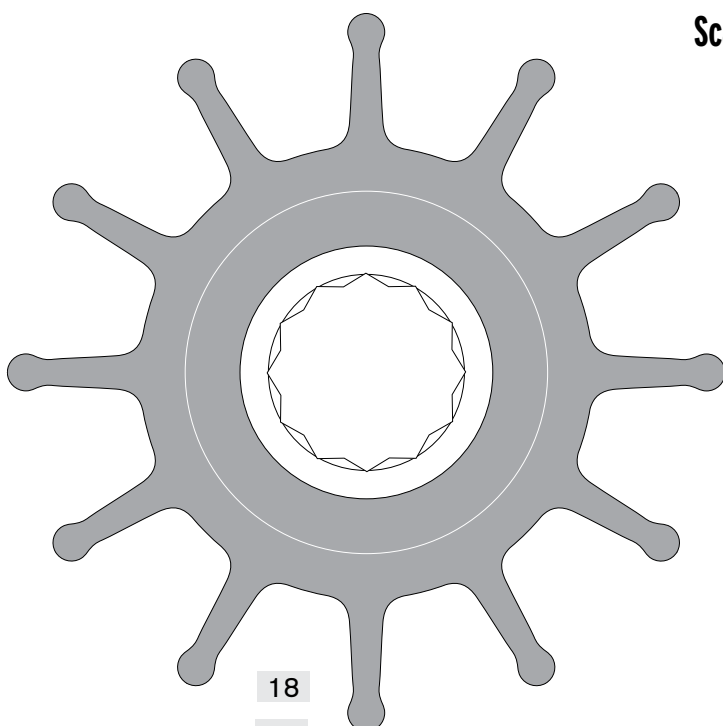

18

19

Scale 1:1

Ref.	Pump type	Item Code
1	F2	66-09-1077B-9
2	F3	66-09-843S-9
3	TA3P10	66-09-1052S-9
4	F35	66-09-806B-1
5	F35	66-09-808B-1
6	F4	66-09-824P-1
6	F4	66-09-824P-9
7	F4	66-09-810B-1
7	F4	66-09-810B-9
8	F4	66-09-1026B-1
8	F4	66-09-1026B-9
9	F5	66-09-801B
10	F5	66-09-1027B-1
10	F5	66-09-1027B-9
11	F6	66-09-812B-1
12	F7	66-09-1028BT-1
12	F7	66-09-1028B-9
13	F75	66-09-821BT-1
14	F8	66-09-819B
14	F8	66-09-819B-9
15	F8	66-09-1029B*
16	F9	66-09-802B
17	F9	66-09-814B
18	F95	66-09-820B
19	F98	66-09-842B

\* Alternative impeller 66-09-819B

## Replacement impellers: Scale 1:1

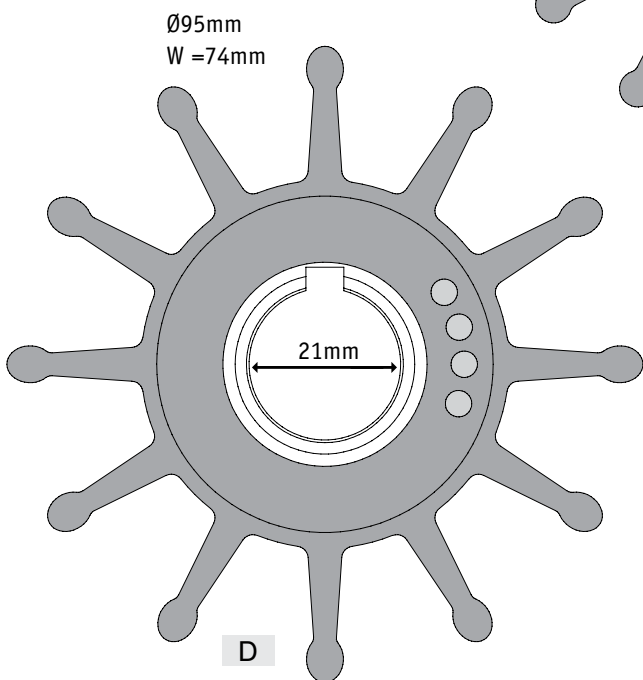
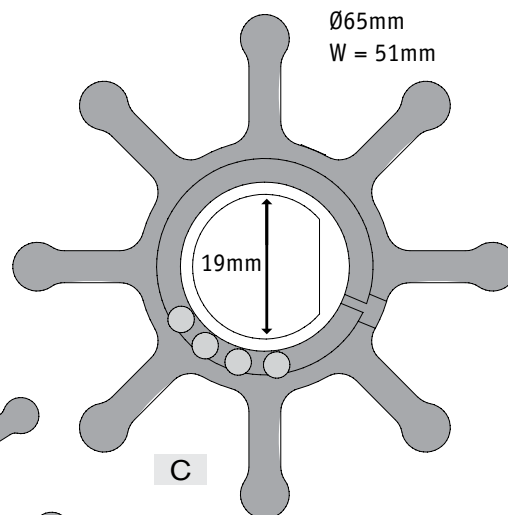
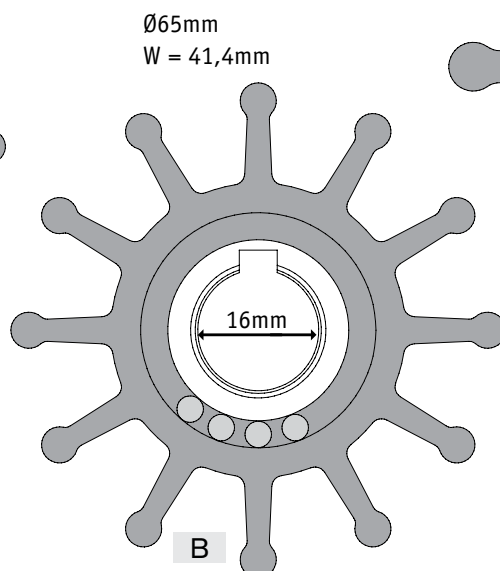
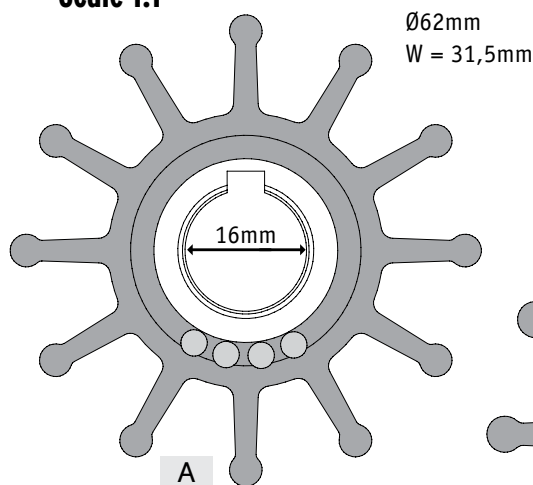

## Replacement impellers:

Ref.	SPX Johnson Pump part no.	Sherwood part no.	allpa part no.	Jabsco part no.	Engines / Pumps
A	<b>66-09-701B-1</b>	9959K	500103	18838-0001	Chris Craft; Chrysler Marine; Commander; Crusader; Glastron Boat Co.; Gray Marine; Interceptor; Onan; OMC; Pathfinder VolksWagon Eng.; Perkins Eng. U.S.; Plesurecraft Marine; Universal Medalist; Volvo Penta; Yamaha; Westerbeke 24102; Sherwood 11353; Pleasure Craft 302&351; Chris Craft 350; Onan MDL3,4
B	<b>66-09-702B-1</b>	10615K	500120	18948-0001	Chris Craft; Chrysler Marine; Commander; Crusader; Escort (Skiltec); Gray Marine; Isuzu; Lenco; Marine Power; North American Engine; Onan; Osco Motors; OMC; Perkins Engine U.S.; Plesurecraft Marine; Volvo Penta; J.H. Westerbeke Corp; Crusader 97179; Chrysler 3675763; Chrysler 4142878; Cummins 4B; Onan MDL6; Chris Craft 454; Pleasure Craft 454
C	<b>66-09-703P-1</b>	-	500109	17954-0001	Pump Quicksilver Model 46-72774 A32 (ref. 47-59362T)
D	<b>66-09-704BT-1</b>	17000K	500164	18958-0001	Cummins 6B 300Hp B Series; Cummins C Series; CAT 3208; CAT 3116; CAT 3126; Deere 6076; Sherwood Pump P17 series

These end covers are illustrated in full scale for easy identification

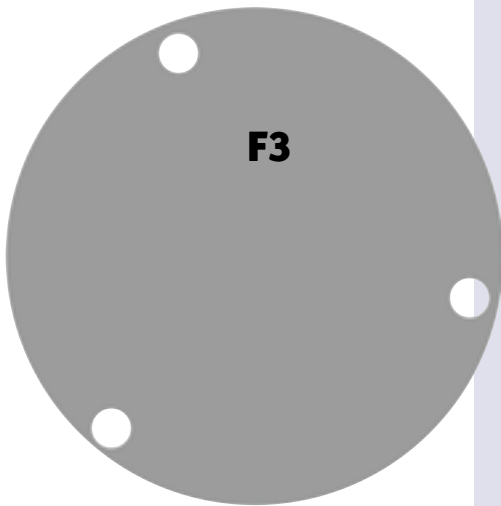

**F3**

**Item Code 66-01-43141**  
F3 End Cover

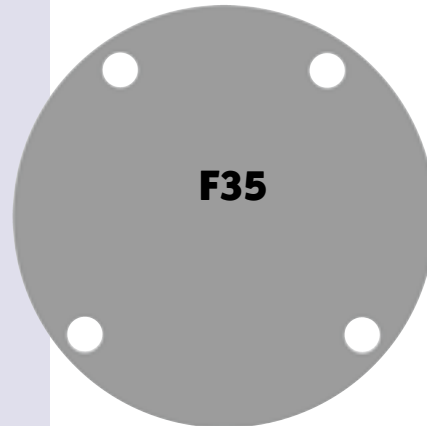

**F35**

**Item Code 66-01-43239**  
F35 End Cover  
Replaces Jabsco 29305.

**Johnson Pump  
End Covers**

**Scale 1:1**

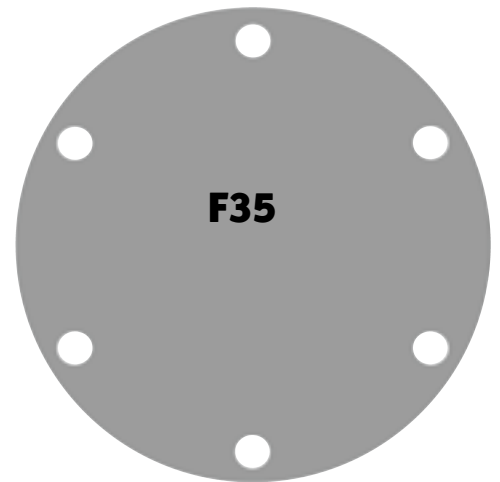

**F35**

**Item Code 66-01-42414**  
F35 End Cover  
Replaces Jabsco AL6-200.

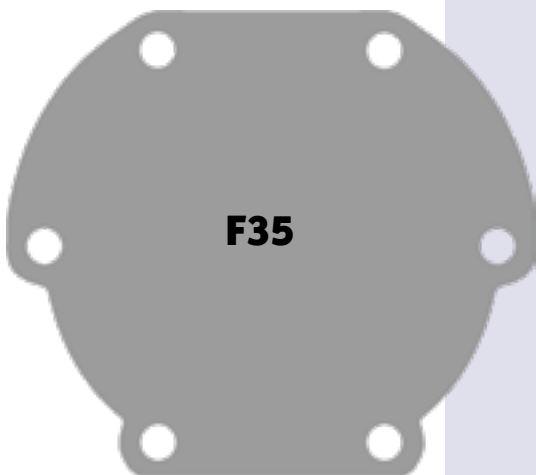

**F35**

**Item Code 66-01-45282**  
F4 End Cover  
Replaces Jabsco 29475

**Item Code 66-01-42398**  
F4 / F5 End Cover  
Replaces Jabsco 3992

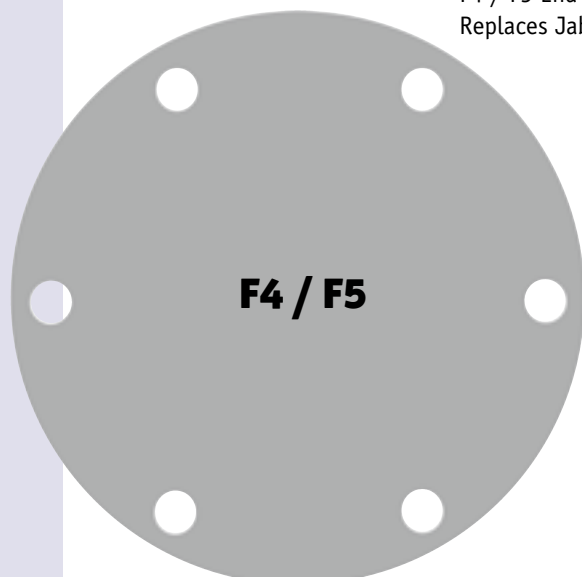

**F4 / F5**



These end covers are illustrated in full scale for easy identification

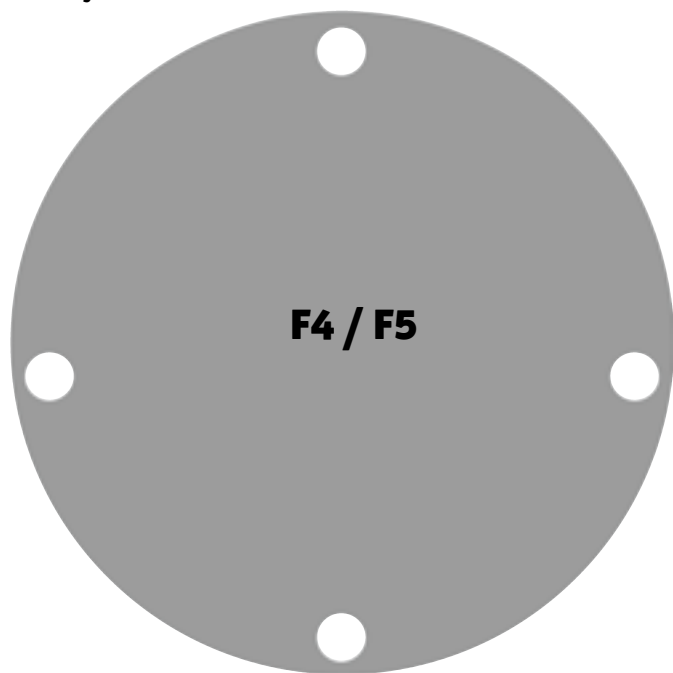

**Item Code 66-01-46556**  
F5 / F6 End Cover

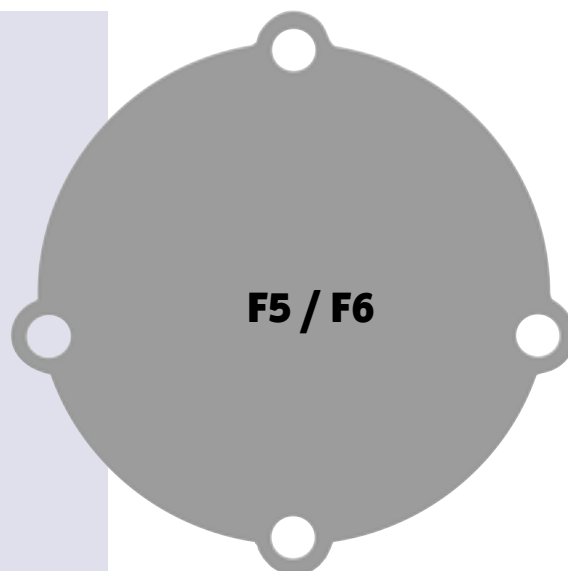

**Item Code 66-01-45312-1**  
F5 / F6 End Cover

## Johnson Pump End Covers

Scale 1:1

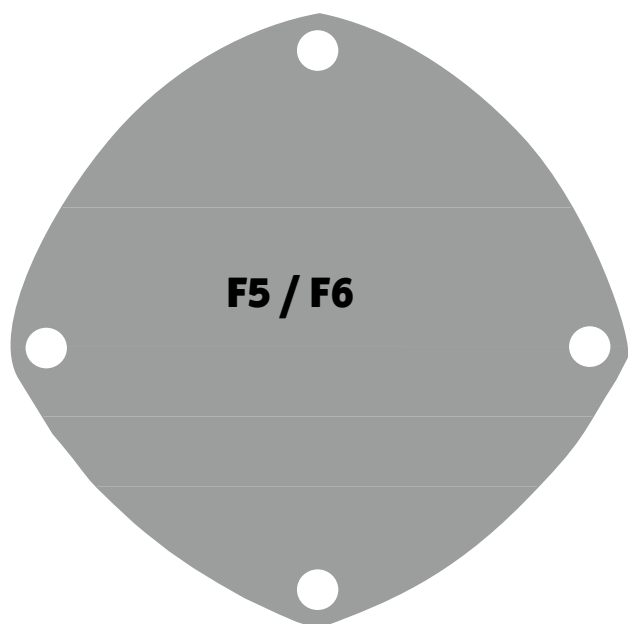

**Item Code 66-01-46535**  
F5 / F6 End Cover

**Item Code 66-01-42441**

F7 End Cover (bronze)  
Replaces Jabsco 3993

**Item Code 66-01-46648-3**

F7 End Cover (stainless steel) with groove  
for O-ring (F7B-8 new)

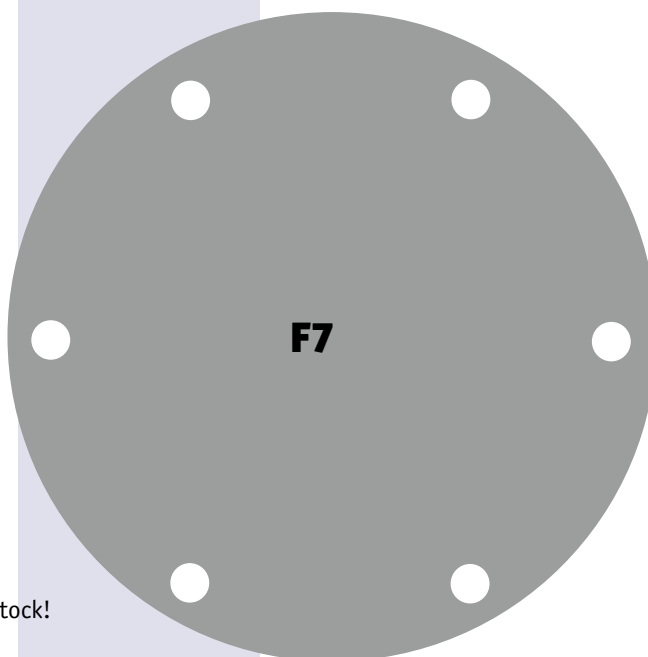

End covers for F8 and F9 pumps are available from stock!

Jabsco ↔ **allpa**  
marine equipment

# Johnson Pump

## Article number reference list



You may have to remove a line before the allpa article number.

<b>Ball bearing</b>	S P2600-06	660508126	4528-0001	66098018
<b>Cam</b>	490	660142397	6303-0003	66098212
	834	660142680	673-0001	660910258
	934	660142679	673-0003	660910259
	2431	660142584	673-0004	660980125
	2441	660145084	EUR 86-0001	660910298
	2551	660142755	EUR 86-0002	66098198
	3255	660142442	EUR 86-0003	66098198
	6988	660143137	EUR 86-0003	66098198
	10338	66014566014	Key X4000	660503125
	10818	660142389	Key X4000	660503125
	22039	660143135	Lip seal 22039-48	660529142
	22268	660143138	Lip seal 22268-04	660529120
	29303	660142910	Lip seal P2701-04	660529111
	2907-0001	660145288	Lip seal P2701-11	660529111
	29303-01	660142415	Mechanical seal 22617-0010	66098198
AL8	660142910	Impeller 9700	66098198	
AL8-01	660142415	Impeller 9900	66098198	
<b>Endcover</b>	3992	660142397	10670	66098198
	3993	660142415	10670	66098198
	5522	660142415	10670	66098198
	9336	660142415-1	10670	66098198
	9406	660142415	10670	66098198
	9905	660142415	10670	66098198
<b>Gasket</b>	10670-200	661013022-1	10670-200	661013022-1
	10670-201	661013022-5	10670-201	661013022-5
	10670-201	661013022-2	10670-201	661013022-2
	10670-201	661013022-6	10670-201	661013022-6
	10670-210	661013022-3	10670-210	661013022-3
	10670-210	661013022-7	10670-210	661013022-7
	10670-211	661013022-4	10670-211	661013022-4
	10670-211	661013022-8	10670-211	661013022-8
	10680-200	661022362-1	10680-200	661022362-1
	10680-201	661022362-2	10680-201	661022362-2
<b>Impeller</b>	1210-0001	66091027B	10680-210	661022362-3
	1210-0003	66091027B-9	10680-211	661022362-4
	USA 13554-001	6609812B	10770-0051	661024315-01
	USA 17935-0001	66091029B	10770-0151	661024026-1
	USA 17935-0001	6609819B	10770-0251	661024027-1
	USA 17935-0003	66091029B-9	10770-57	661021915-1
	USA 17935-0003	6609819B-9	10800-21	661011236-2
	USA 17936-0001	6609814B	10800-21	661022139-1
	17937-0001	66091028B	10880-0101	661024091-1
	17937-0003	66091028B-9	10880-0151	661024091-2
	18653-0001	6609810B	10880-0151	661024091-3
	EUR 21676-0001	6609814B	10950-200	661022143-1
	22405-0001	6609808B	10950-201	661022143-1
	4528-0001	6609806B	10950-201	661024140-1

for Info and CHECK





# Solé Marine Engines



#### NOTE:

- All Solé Marine Engines comply with Euro Control Declaration of Conformity as regards Exhaust Emission
- Solé Mini 17, 29, 33 and 44 have Bodensee-Admittance (BS02)
- Solé Mini 33 and 43 are available on request as Lifeboat Engine with SOLAS Type-Approval



#### Light and Compact

SOLÉ engines are outstanding for their low weight and small size due to their new compact design and the use of materials such as cast iron and aluminum.

#### Heat Exchanger

The cooling system using a thermostatically controlled heat exchanger keeps the engine on a constant working temperature resulting in a longer life and optimal combustion.

#### Electric Installation

12V starter motor, powerful alternator with built-in regulator. Instrument panel with tachometer, hour counter, starter key switch, temperature gauge, audible and visual alarm on low oil pressure, high temperature and battery charging, 3m wiring, (4m starting from Mini 62/G). Starting from Mini 74, the instrument panels also have volt and oil pressure gauges.

#### Standard Equipment

All engines come complete with: reversing gear, flexible mounts circulation pump, sea-water pump, water cooled exhaust manifold with heat exchanger, complete electric installation, fuel supply pump, fuel filter, oil filter, electric stop, connection kits for control cables, instruction and parts manual.

#### Warranty:

The warranty term for Pleasure use is 5 year (24 + 36 months)

#### Standard limited manufacturer's warranty:

- Propulsion engines => 24 months or 1.000 hours.
- Generators => 24 months or 1.000 hours.

#### Extended limited manufacturer's warranty\*:

- Propulsion engines => 36 months or 1.500 hours.
- Generators => 36 months or 1.000 hours.

\*The extended manufacturer's warranty term applies to the following parts:

Engine block - Cylinder head - Crank shaft - Cam shaft - Flywheel housing - Timing gear case - Timing gears - Connecting rods.

#### The warranty term for Commercial use is:

- Propulsion engines => 12 months or 2.000 hours (commercial use).  
=> 24 months or 2.000 hours (charter).
- Generators => 12 months or 1.000 hours.

\*Conditions available upon request

# Marine Engine Range



**allpa**  
marine equipment

Item Code 022010/11



22.13840110

**Solé Mini 17**  
 (Based on Mitsubishi,  
 2 cylinder  
 16HP / 11,7kW)

**Bodensee  
 Admittance  
 (BS0-2)**

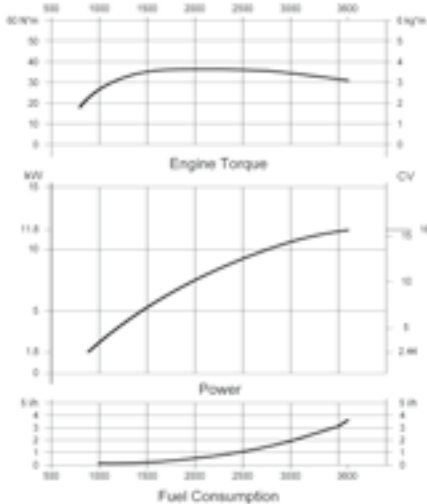

**Standard equipment:**

Flexible mounts, standard instruments panel, gearbox, wiring loom and instruction manual.

Type Diesel,	4-stroke
No. of cylinders	2 in line
Bore x stroke	76 x 70mm
Total displacement	635cc
Compression ratio	23:1
Max. output	DIN6270B 16HP / 11,77kW
Max. speed	3.600 rpm
Max. torque	32Nm at 2.300 rpm
Combustion system	Indirect mechanical injection
Cooling system	Fresh water, using heat exchanger, cooled exhaust manifold
Electrical system	12V starter motor, 1,2kW
Alternator	75A
Gearbox Technodrive	TMC40
Weight:	
- with gear box	98kg
- with Sail Drive	127kg (incl. polyester base)
Max. installation angle	22°(+3° discontinuous)
ØExhaust	40mm
ØSea-water intake	20mm
ØFuel intake	6mm
ØFuel return	5mm

**Certifications EU: RCD II (Directive 2013/53/EU), BSO II**

<b>Item Code 022010</b>	<b>Solé Mini 17,</b> with gear box Technodrive TMC40, R = 2,00:1
<b>Item Code 022011</b>	<b>Solé Mini 17,</b> with gear box Technodrive TMC40, R = 2,60:1
<b>Item Code 022162</b>	<b>Solé Mini 17/SD,</b> with Technodrive Sea Prop - Sail drive & base R=2,15:1

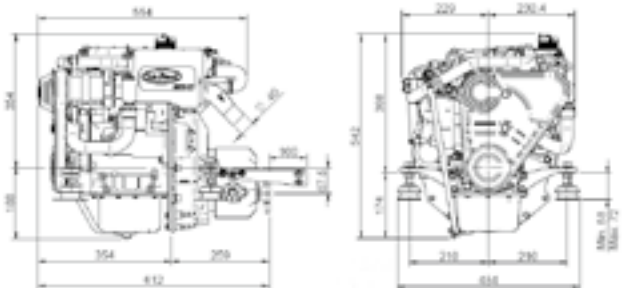

**Parts see p. 529**



Standard equipment:  
Flexible mounts, standard instruments panel,  
gearbox, wiring loom and instruction manual.

Type	Diesel, 4-stroke
No. of cylinders	3 in line
Bore x stroke	76 x 70mm
Total displacement	952 cc
Compression ratio	22:1
Max. output	DIN6270B 27.2HP /20kW
Max. speed	3.600 rpm
Max. torque	52Nm at 1.800 rpm
Combustion system	Indirect mechanical injection
Cooling system	Fresh water, using heat exchanger, cooled exhaust manifold
Electrical system	12V starter motor, 1,2kW
Alternator	75A
Gearbox	Technodrive TMC40
Weight:	105kg
with Sail Drive	134kg (incl. base)
Max. installation angle	20° 22°(+3°discontinuous)
ØExhaust	50mm
ØSea-water intake	20mm
ØFuel intake	6mm
ØFuel return	5mm

**Certifications EU: RCD II (Directive 2013/53/EU), BSO II**

<b>Item Code 022025</b>	<b>Solé Mini 29,</b> with gearbox TMC 40, R=2.00:1
<b>Item Code 022026</b>	<b>Solé Mini 29,</b> with gearbox TMC 40, R=2.60:1
<b>Item Code 022065</b>	<b>Solé Mini 29SD,</b> with Technodrive Saildrive, R=2.15:1 and base

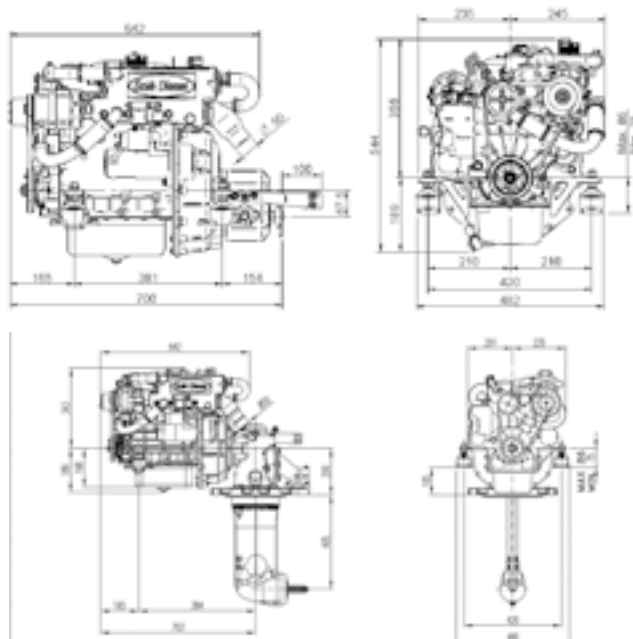

Item Code 022025/26



### Solé Mini 29

(Based on Mitsubishi,  
3 cylinder  
27.2HP / 20kW)



22.13840110

**Parts see p. 529**

**Bodensee  
Admittance  
(BSO-2)**

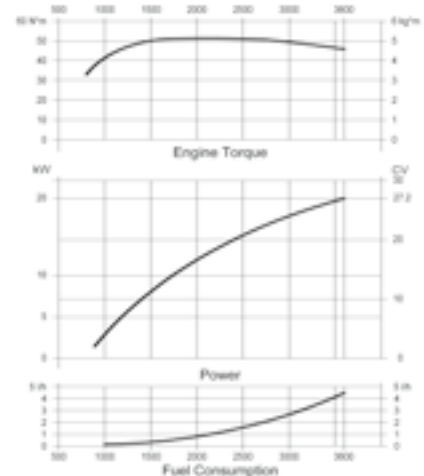



## Solé 'sportbootführerscheinfrei' Engines

allpa supplies, especially for the German market, Solé Marine Diesel Engines which do not deliver over 15HP (11kW) and therefore may be used without a license ('Sportbootführerschein').

These engines are RCD-homologated and come with a certificate.

These engines are:

- Solé model Mini 17 adjusted at 15HP (11kW) @ 3.200 rpm
- Solé model Mini-29/26G adjusted at 15HP (11kW) @ 1.800 rpm

Solé Mini 17



Solé Mini 29

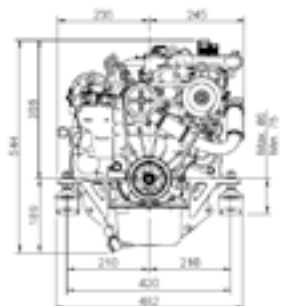
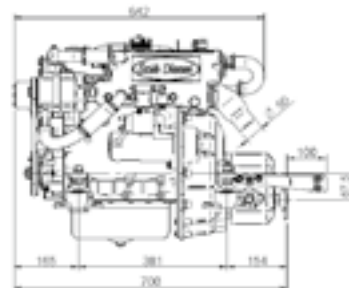
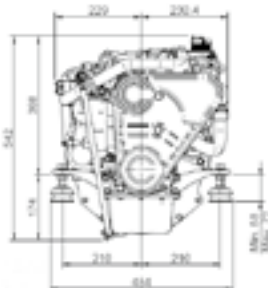
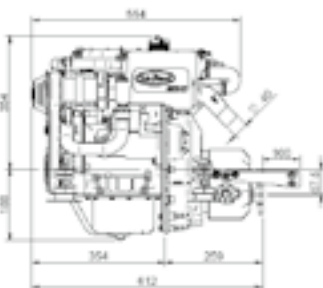





**Standard equipment:**

Flexible mounts, standard instruments panel, gearbox, wiring loom and instruction manual.

Type Diesel, 4-stroke  
 No. of cylinders 3 in line  
 Bore x stroke 78 x 92mm  
 Total displacement 1.318cc  
 Compression ratio 22:1  
 Max. output DIN6270B 32HP / 23,5kW  
 Max. speed 3.000rpm  
 Max. torque 82Nm at 1.800rpm  
 Combustion system Indirect mechanical injection  
 Cooling system Fresh water, using heat exchanger, cooled exhaust manifold

Electrical system 12V starter motor, 1,7kW  
 Alternator 95A  
 Gearbox Technodrive

Weight:  
 - with gear box 155kg  
 - with Sail Drive 176kg (without base)  
 Max. installation angle 12° (+3° with discontinuous)  
 ØExhaust 50mm  
 ØSea-water intake 20mm  
 ØFuel intake 6mm  
 ØFuel return 5mm

**Certifications EU: RCD II (Directive 2013/53/EU), BSO II**

- Item Code 022030 Solé Mini 33, with gearbox**  
Technodrive TMC40P, R=2.00:1
- Item Code 022032 Solé Mini 33, with gearbox**  
Technodrive TMC60P, R=2.00:1
- Item Code 022033 Solé Mini 33, with gearbox**  
Technodrive TMC60P, R=2.45:1
- Item Code 022034 Solé Mini 33, with gearbox**  
Technodrive TMC60P, R=2,83:1
- Item Code 022038 Solé Mini 33, with gearbox**  
Technodrive TMC260, R=2,88:1
- Item Code 022133 Solé Mini 33, with hydraulic gearbox**  
Technodrive TM345, R=2.00:1
- Item Code 022134 Solé Mini 33, with hydraulic gearbox**  
Technodrive TM345, R=2.47:1
- Item Code 022165 Solé Mini 33, with Saildrive**  
Technodrive Sea Prop, R = 2.15:1, and base

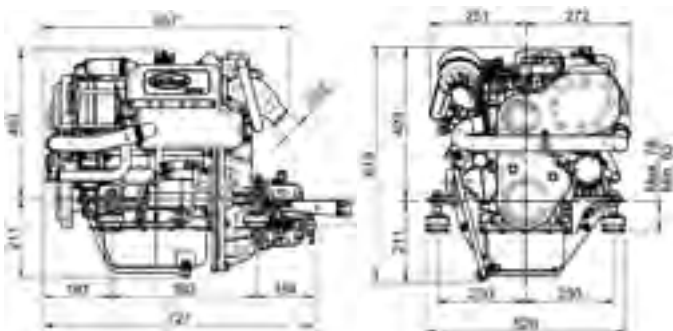

**Solé Mini 33**

(Based on Mitsubishi,

**3 cylinder**

**32HP / 23,5kW)**

**Bodensee  
 Admittance  
 (BSO-2)**

**Also available  
 with lifeboat  
 SOLAS Type  
 Approval**

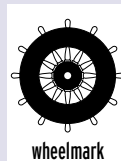

22.13840110

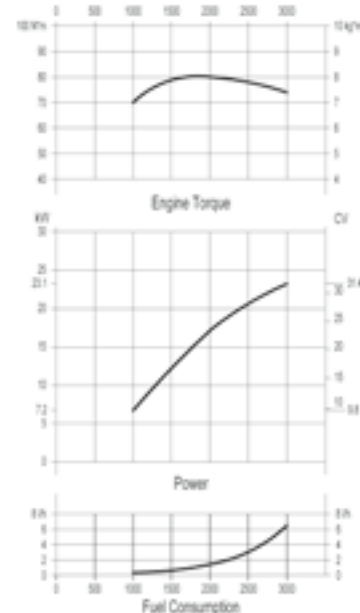



22.13840110

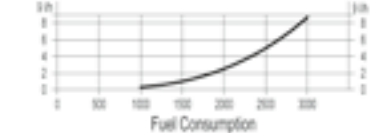
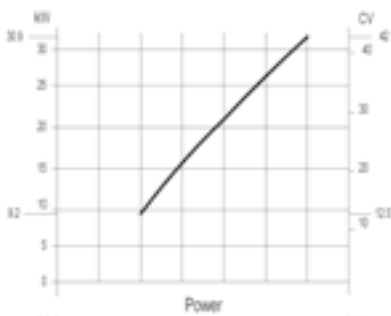
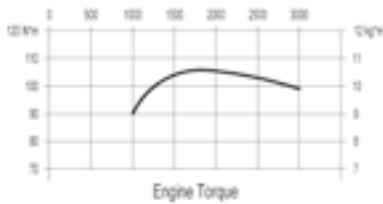

**Solé Mini 44**  
(based on Mitsubishi,  
4 cylinder  
42HP / 30,9kW)

**Bodensee  
Admittance  
(BSO-2)**

**Also available  
with lifeboat  
SOLAS Type  
Approval**

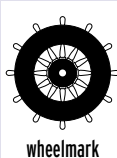

Standard equipment:

Flexible mounts, standard instruments panel, gearbox, wiring loom and instruction manual.

Type	Diesel, 4-stroke
No. of cylinders	4 in line
Bore x stroke	78 x 92mm
Total displacement	1.758cc
Compression ratio	22:1
Max. output	DIN6270B 42HP / 30,9kW
Max. speed	3.000 rpm
Max. torque	106Nm at 1.900 rpm
Combustion system	Indirect mechanical injection
Cooling system	Fresh water, using heat exchanger, cooled exhaust manifold

Electrical system 12V starter motor, 2,0kW

Alternator 95A

Gearbox Technodrive

Weight:

- with gear box 190kg

- with Sail Drive 210kg (without base)

Max. installation angle 12° (+3° with discontinuous)

ØExhaust 50mm

ØSea-water intake 20mm

ØFuel intake 6mm

ØFuel return 5mm

**Certifications EU: RCD II (Directive 2013/53/EU), BSO II**

<b>Item Code 022041</b>	<b>Solé Mini 44</b> , with gearbox Technodrive TMC60P, R=1,55:1
<b>Item Code 022042</b>	<b>Solé Mini 44</b> , with gearbox Technodrive TMC60P, R=2,00:1
<b>Item Code 022045</b>	<b>Solé Mini 44</b> , with gearbox Technodrive TMC260, R=2,88:1
<b>Item Code 022143</b>	<b>Solé Mini 44</b> , with hydraulic gearbox Technodrive TM345, R=2.00:1
<b>Item Code 022144</b>	<b>Solé Mini 44</b> , with hydraulic gearbox Technodrive TM345, R=2.47:1
<b>Item Code 022166</b>	<b>Solé Mini 44</b> , with Saildrive Technodrive Sea Prop, R= 2.15:1, and base

**Mini 44 with TMC60P**

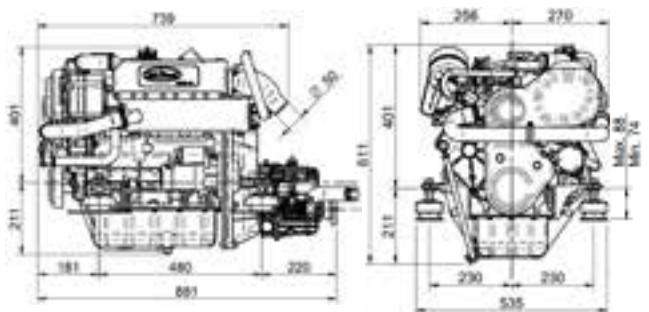

**Mini 44 with TM345**

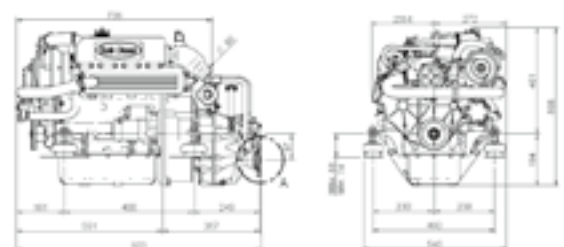

Parts see p. 529



Standard equipment:  
Flexible mounts, standard instruments panel,  
gearbox, wiring loom and instruction manual.

Type	Diesel, 4-stroke
No. of cylinders	4 in line
Bore x stroke	78 x 92mm
Total displacement	1.758cc
Compression ratio	22:1
Max. output	DIN6270B 52HP /38,3kW
Max. speed	3.000 rpm
Max. torque	125Nm at 1.900 rpm
Combustion system	Indirect mechanical injection
Cooling system	Fresh water, using heat exchanger, cooled exhaust manifold
Electrical system	12 V starter motor, 1,7kW
Alternator	95A
Gear box	Technodrive
Weight:	189kg
with Sail Drive	189kg (incl. base)
Max. installation angle	12° (+3° with discontinuous)
ØExhaust	60mm
ØSea-water intake	26mm
ØFuel intake	6mm
ØFuel return	5mm

**Certifications EU: RCD II (Directive 2013/53/EU)**

<b>Item Code 022200</b>	<b>Solé Mini 55</b> , with gearbox Technodrive TMC260E, R=2.00:1
<b>Item Code 022201</b>	<b>Solé Mini 55</b> , with gearbox Technodrive TMC260E, R=2.45:1
<b>Item Code 022206</b>	<b>Solé Mini 55</b> , with hydraulic gearbox Technodrive TM345, R=2.00:1
<b>Item Code 022207</b>	<b>Solé Mini 55</b> , with hydraulic gearbox Technodrive TM345, R=2.47:1
<b>Item Code 022209</b>	<b>Solé Mini 55</b> , with Saildrive Technodrive Sea Prop, R = 2.15:1, and base

**Mini 55 with TMC260**

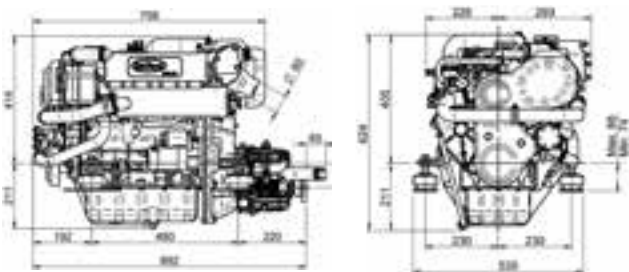

**Mini 55 with TM345**

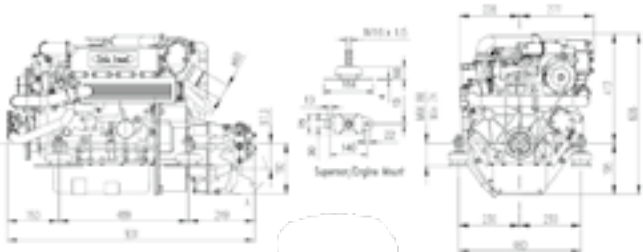

**Solé Mini 55**  
(Based on Mitsubishi,  
4 cylinder  
52HP / 38,3kW)

22.17740110

Engine Torque

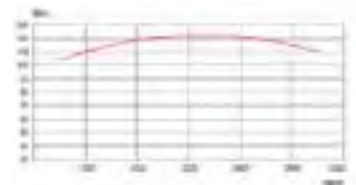

Power

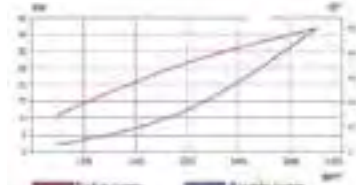

Fuel Consumption

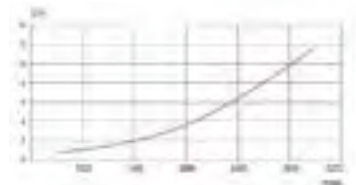

Parts see p. 529



Standard equipment:  
Flexible mounts, standard instruments panel,  
gearbox, wiring loom and instruction manual.

Type	Diesel, 4-stroke
No.° of cylinders	4 in line
Bore x stroke	88 x 95mm
Total displacement	2.311cc
Compression ratio	22:1
Max. output	DIN6270B 35HP / 26kW <i>(former M62: 59HP/43,4kW)</i>
Max. speed	1.700 rpm <i>(former M62: 3000 rpm)</i>
Max. torque	142Nm at 1.700 rpm
Combustion system	Indirect mechanical injection
Cooling system	Fresh water, using heat exchanger, cooled exhaust manifold
Electrical system	12V starter motor, 2,0kW
Alternator	95A
Gearbox	Technodrive
Weight:	
- with gear box	240kg
- with Sail Drive	260kg (without base)
Max. installation angle	12° (+3° with discontinuous)
ØExhaust	60mm
ØSea-water intake	32mm
ØFuel intake	8mm
ØFuel return	6mm

**Solé Mini 62/G**  
(Based on Mitsubishi,  
4 cylinder  
35HP / 26kW)



22.17140110

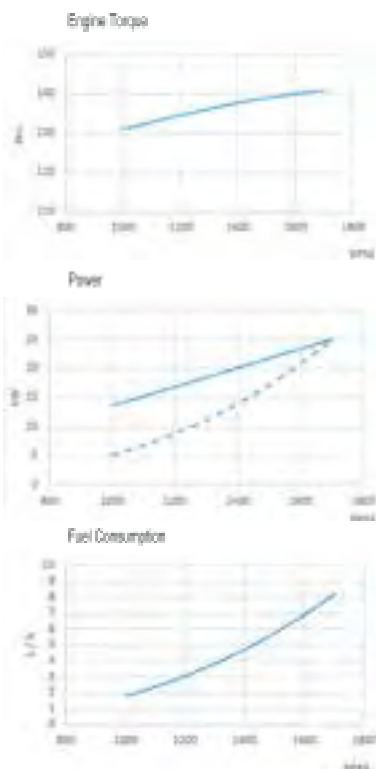

**Certifications EU: RCD II (Directive 2013/53/EU)**

<b>Item Code 022050</b>	<b>Solé Mini 62/G</b> , with gearbox Technodrive TMC260E, R=2.00:1
<b>Item Code 022051</b>	<b>Solé Mini 62/G</b> , with gearbox Technodrive TMC260E, R=2.45:1
<b>Item Code 022153</b>	<b>Solé Mini 62/G</b> , with hydraulic gearbox Technodrive TM345, R=2.00:1
<b>Item Code 022154</b>	<b>Solé Mini 62/G</b> , with hydraulic gearbox Technodrive TM345, R=2.47:1
<b>Item Code 022167</b>	<b>Solé Mini 62/G</b> , with Saildrive Technodrive Sea Prop, R = 2.15:1, and base

**Mini 62/G with TMC260**

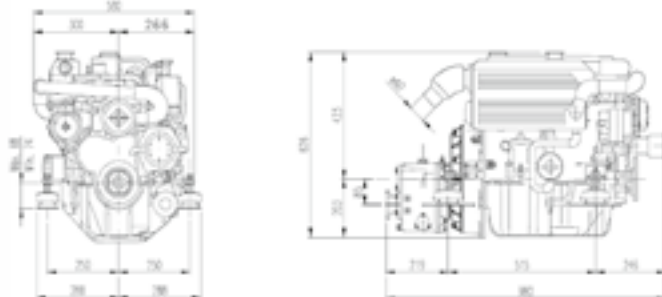

**Mini 62/G with TM345**

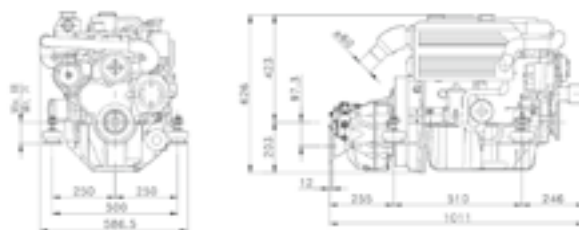



Standard equipment:  
Flexible mounts, standard instruments panel,  
Gearbox, wiring loom and instruction manual.

Type	Turbo Diesel, 4-stroke
No. of cylinders	4 in line
Bore x stroke	87 x 102mm
Total displacement	2434cc
Compression ratio	22.5:1
Max. output ISO 3046/1	60HP / 44.5kW
Max. speed	2.700 rpm
Max. torque	165Nm @1.850rpm
Combustion system	Indirect mechanical injection
Cooling System	Fresh water, using heat exchanger
Electrical system	12V Startmotor, 2.0kW, alternator 120A
Gear box	Technodrive
Weight	243kg (including TM345)
Max. installation angle	17° (+3° with discontinuous)
Ø Exhaust	60mm
Ø Sea-water intake	32mm
Ø Fuel intake	8mm
Ø Fuel return	6mm
Certifications	EU RCD Tier II

**Certifications EU: RCD II (Directive 2013/53/EU)**

<b>Item Code 022348</b>	<b>Solé SK-60,</b> with gearbox TMC260, R=2.00:1
<b>Item Code 022347</b>	<b>Solé SK-60,</b> with gearbox TMC260, R=2.47:1
<b>Item Code 022349</b>	<b>Solé SK-60,</b> with hydraulic gearbox TM345, R=2.00:1
<b>Item Code 022350</b>	<b>Solé SK-60,</b> with hydraulic gearbox TM345, R=2.47:1
<b>Item Code 022355</b>	<b>Solé SK-60,</b> with Saildrive Technodrive Sea Prop R=2.15:1 and base

**Parts see p. 529**

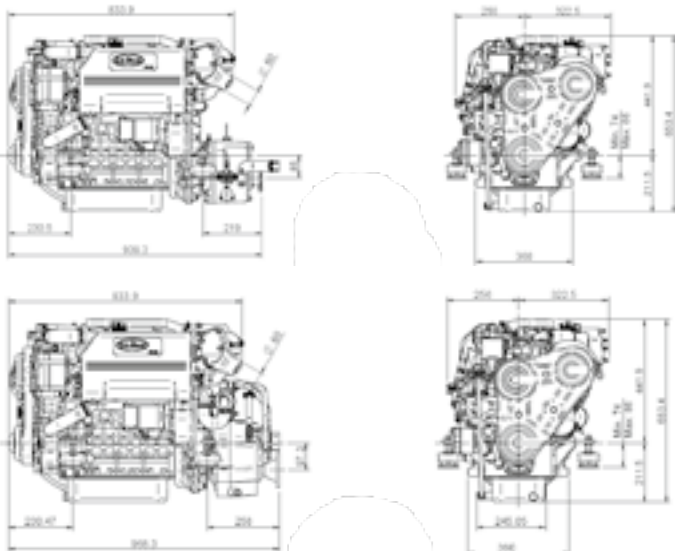

**Solé SK-60**  
(Based on Kubota,  
4 cylinder  
60HP / 44.5kW)



22.1A040103

Engine Torque

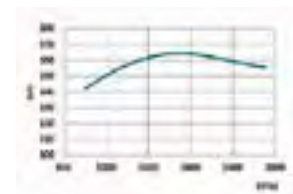

Power

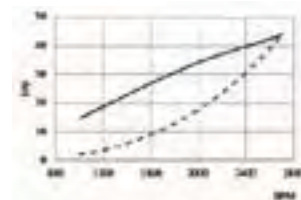

Fuel Consumption

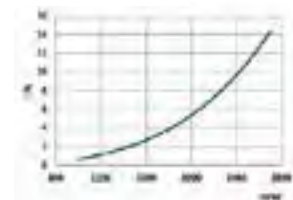



22.17440110

**Solé Mini 74**  
 (based on Mitsubishi,  
 4 cylinder  
 70HP / 51,4kW)

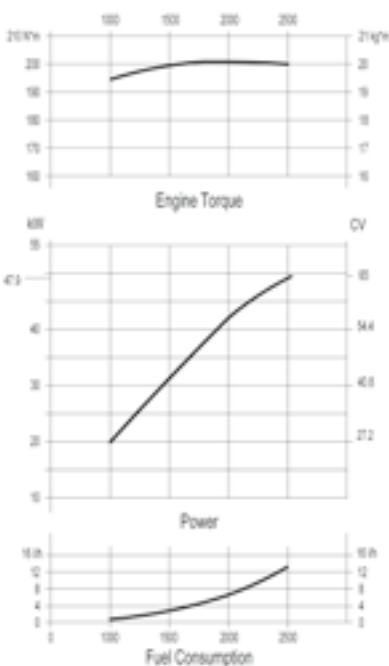

Standard equipment:  
 Flexible mounts, deluxe instruments panel,  
 gearbox, wiring loom and instruction manual.

Type	Diesel, 4-stroke
No. of cylinders	4 in line
Bore x stroke	94 x 120mm
Total displacement	3.331cc
Compression ratio	22:1
Max. output	DIN6270B 70HP / 51,4kW
Max. speed	2.500 rpm
Max. torque	200Nm at 1.400rpm
Combustion system	Indirect mechanical injection
Cooling system	Fresh water, using heat exchanger, cooled exhaust manifold
Electrical system	12V starter motor, 2.2kw
Alternator	95A
Gear box	Technodrive hydraulic
Weight with gear box	340kg
Max. installation angle	12° (+3° with discontinuous)
ØExhaust	76mm
ØSea-water intake	32mm
ØFuel intake	8mm
ØFuel return	8mm

**Certifications EU: RCD II (Directive 2013/53/EU)**

<b>Item Code 022170</b>	<b>Solé Mini 74</b> with gear box TM345, R=2.00:1
<b>Item Code 022171</b>	<b>Solé Mini 74</b> with gear box TM345, R=2.47:1
<b>Item Code 022370</b>	<b>Solé Mini 74</b> with gear box TM93, R=2.09:1
<b>Item Code 022177</b>	<b>Solé Mini 74</b> with gear box TM93, R=2.40:1
<b>Item Code 022178</b>	<b>Solé Mini 74</b> with gear box TM93, R=2.77:1

**Parts see p. 529**

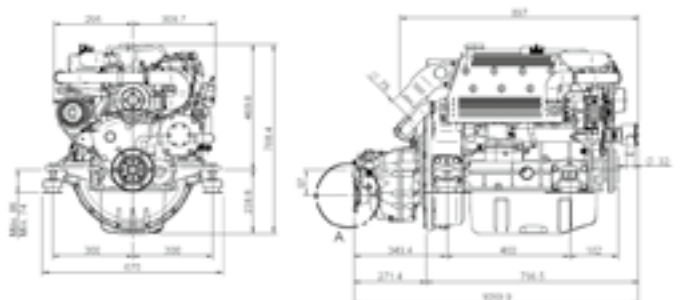



**Standard equipment:**

Flexible mounts, deluxe instruments panel, gearbox, wiring loom and instruction manual.

Type	Turbo Diesel, 4-stroke
No. Of cylinders	4 in Line
Bore x stroke	94 x 120mm
Total displacement	3331cc
Compression ratio	22:1
Max. output ISO 3046/1	82HP / 60.3kW
Max. speed	2500 rpm
Max. torque	268Nm at 1.350rpm
Combustion system	Indirect mechanical injection
Cooling system	Fresh water, Using heat exchanger, Cooled exhaust manifold
Electrical system	12V starter motor, 2.2kW, Alternator 95A
Gear box	Technodrive, hydraulic
Weight	362kg (including TM345)
Max. installation angle	12° (+3° with discontinuous)
Ø Exhaust	76mm
Ø Sea-water intake	32mm
Ø Fuel intake	8mm
Ø Fuel return	8mm

**Certifications EU: RCD II (Directive 2013/53/EU)**

<b>Item Code 022632</b>	<b>Solé SM-82</b> , with gear box TM345, R=2.00:1
<b>Item Code 022633</b>	<b>Solé SM-82</b> , with gear box TM345A, R=2.00:1
<b>Item Code 022634</b>	<b>Solé SM-82</b> , with gear box TM345, R=2.47:1
<b>Item Code 022635</b>	<b>Solé SM-82</b> , with gear box TM345A, R=2.47:1
<b>Item Code 022638</b>	<b>Solé SM-82</b> , with gear box TM93, R=2.77:1

**Parts see p. 529**

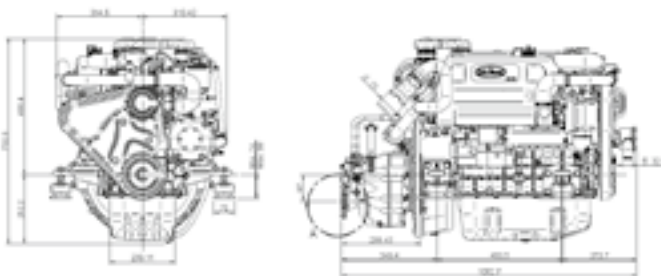

**Solé SM-82**  
(based on Mitsubishi,  
4 cylinder  
82HP / 60,3kW)



22.17840110

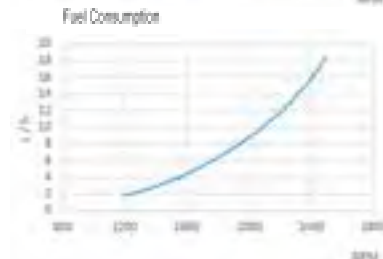
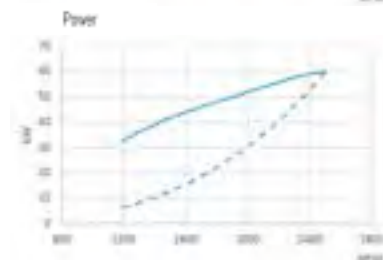
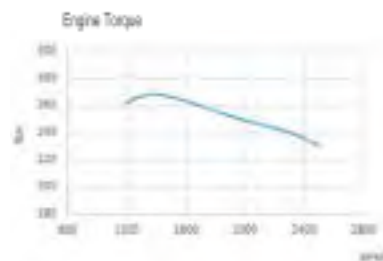

# Takes you further!



Based on: 

Mini 17, 29, 33, 44 & 55  
comply with the new RCD  
Directive Tier II  
Also available with Saildrive



**allpa**  
marine equipment





allpa® The European Marine Distributor

Type	Turbo Diesel, 4-stroke
No. Of cylinders	4 in Line
Bore x stroke	94 x 120mm
Total displacement	3331cc
Compression ratio	22:1
Max. output ISO 3046/1	94HP / 69kW
Max. speed	2500 rpm
Max. torque	298Nm at 1.700rpm
Combustion system	Indirect mechanical injection
Cooling system	Fresh water, Using heat exchanger, Cooled exhaust manifold
Electrical system	12V starter motor, 2.2kW, Alternator 95A
Gear box	Technodrive, hydraulic
Weight	362kg (including TM345)
Max. installation angle	12° (+3° with discontinuous)
Ø Exhaust	76mm
Ø Sea-water intake	32mm
Ø Fuel intake	8mm
Ø Fuel return	8mm



**Solé SM-94**  
(based on Mitsubishi,  
4 cylinder  
94HP / 69kW)



22.17940110

**Certifications EU: RCD II (Directive 2013/53/EU)**

**Item Code 022642 Solé SM-94, with gear box TM345, R=2.00:1**

**Item Code 022644 Solé SM-94, with gear box TM345, R=2.47:1**

**Item Code 022648 Solé SM-94, with gear box TM93, R=2.77:1**

**Parts see p. 529**

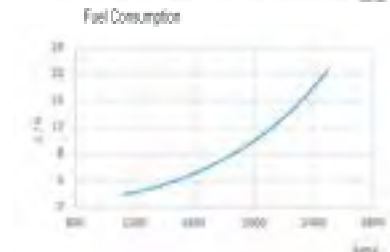
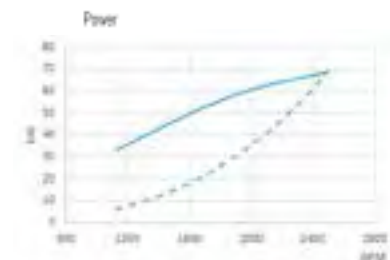
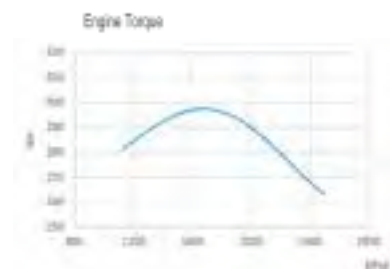
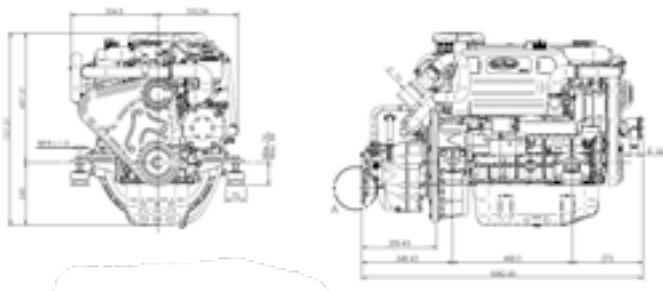



Standard equipment:  
Flexible mounts, standard instruments panel,  
gearbox, wiring loom and instruction manual.



**Solé SM-105/L**  
(Based on Mitsubishi,  
6 cylinder  
76HP / 56kW)



22.17540110



Type	Diesel, 4-stroke
No. of cylinders	6 in line
Bore x stroke	94 x 120mm
Total displacement	4.996cc
Compression ratio	22:1
Max. output	DIN6270B 76HP / 56kW (former SM105: 95HP / 76kW)
Max. speed	2.300 rpm (former SM105: 2.500 rpm)
Max. torque	293Nm at 1.625 rpm
Combustion system	Indirect mechanical injection
Cooling system	Fresh water, using heat exchanger, cooled exhaust manifold
Electrical system	12V starter motor, 3.0kW
Alternator	95A
Gear box	Technodrive hydraulic
Weight:	460kg
Max. installation angle	12° (+3° with discontinuous)
Ø Exhaust	75mm
Ø Sea-water intake	30mm
Ø Fuel intake	8mm
Ø Fuel return	8mm

**Certifications EU: RCD II (Directive 2013/53/EU)**

**Item Code 022190** Solé SM-105/L,  
with gearbox Technodrive TM93,  
R=2.09:1

**Item Code 022191** Solé SM-105/L,  
with gearbox Technodrive TM93,  
R=2.40:1

**Item Code 022198** Solé SM-105/L,  
with gearbox Technodrive TM170,  
R=2.94:1

ENGINE TORQUE

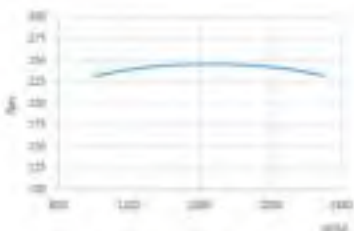

POWER RATING

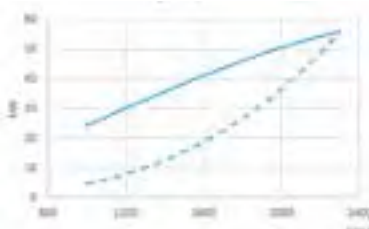

FUEL CONSUMPTION

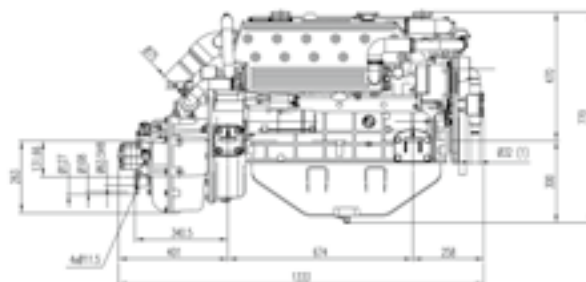
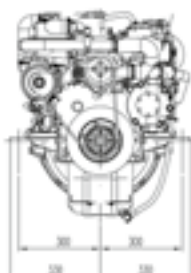
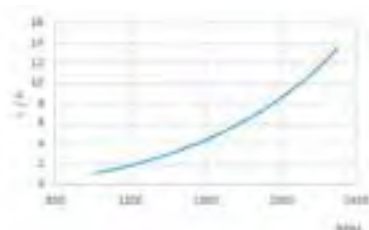

SM-105/L with TM 93

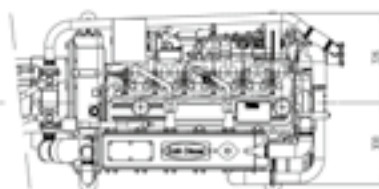

Parts see p. 529



**Standard equipment:**

Flexible mounts, standard instruments panel, gearbox, wiring loom and instruction manual.

Type	Turbo Diesel Intercooler, 4-Stroke
No. of cylinders	4 in line
Bore x stroke	108 x 130mm
Total displacement	4.764cc
Compression ratio	17.6:1
Max. output	DIN6270B 160HP/118kW
Max. speed	2.300 rpm
Max. torque	548Nm at 1.500 rpm
Combustion system	Direct mechanical injection Cooling system Fresh water, using heat exchanger, cooled exhaust manifold and turbo
Electrical system	2 Poles, 24V
Starter motor,	4.0kW
Alternator	55A
Gear box	Technodrive hydraulic
Max. installation angle	7° (+3° with discontinuous)
Ø Exhaust	90mm
Ø Sea-water intake	42mm
Ø Fuel intake	12mm
Ø Fuel return	12mm

**Certifications EU: RCD I (Directive 94/25/EC)**

<b>Item Code 022250</b>	<b>Solé SDZ 165</b> with hydraulic gearbox TM170 R=2,04 :1 - 646kg
<b>Item Code 022251</b>	<b>Solé SDZ 165</b> with hydraulic gearbox TM170 R=2,50 :1 - 646kg
<b>Item Code 022253</b>	<b>Solé SDZ 165</b> with hydraulic gearbox TM170A R=2,08 :1 - 646kg
<b>Item Code 022254</b>	<b>Solé SDZ 165</b> with hydraulic gearbox TM170A R=2,60 :1 - 646kg
<b>Item Code 022256</b>	<b>Solé SDZ 165</b> with hydraulic gearbox TM265 R=2,09 :1 - 729kg
<b>Item Code 022257</b>	<b>Solé SDZ 165</b> with hydraulic gearbox TM265 R=2,82 :1 - 729kg
<b>Item Code 022258</b>	<b>Solé SDZ 165</b> with hydraulic gearbox TM200 R=3,60 :1 - 790kg
<b>Item Code 022259</b>	<b>Solé SDZ 165</b> with hydraulic gearbox TM200 R=4,48 :1 - 790kg

**Parts: See page 529**

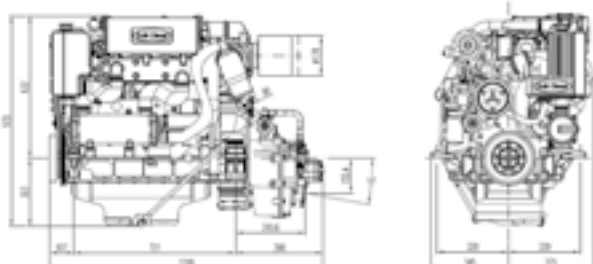

**Solé SDZ 165**  
(based on Deutz  
4 cylinder  
160HP / 118kW)



**22.19440110**

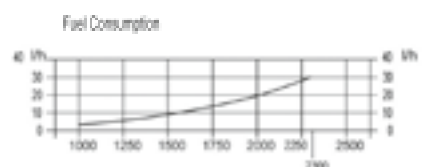
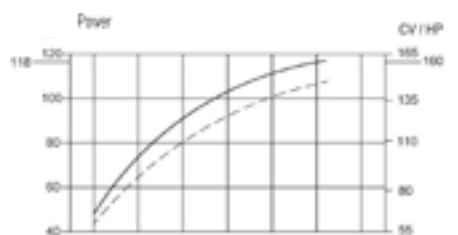
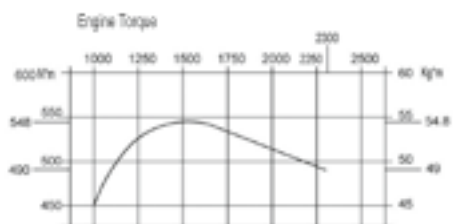

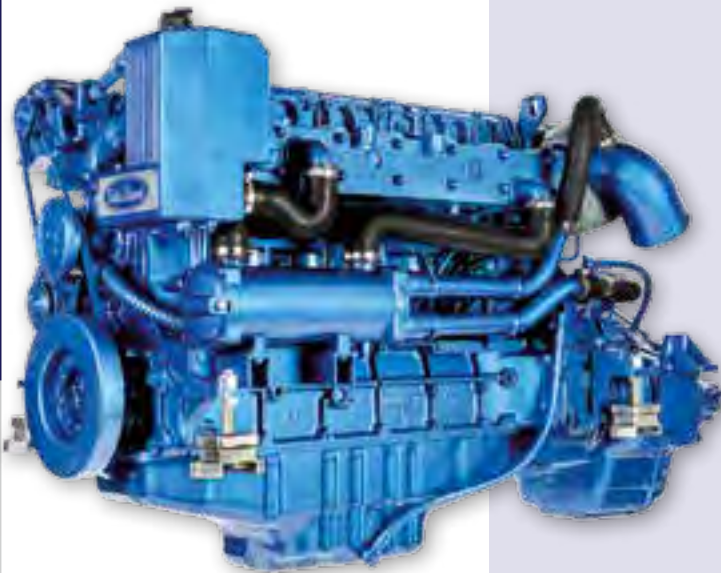

**Solé SDZ 205**  
(Based on Deutz,  
6 cylinder  
197HP / 145kW)

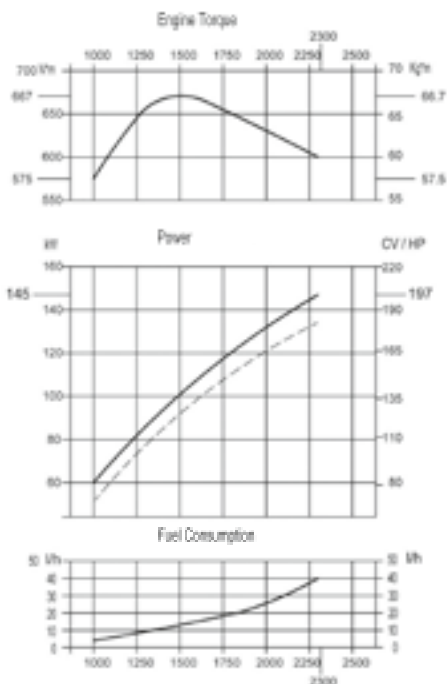

**Standard equipment:**

Flexible mounts, standard instruments panel, gearbox, wiring loom and instruction manual.

Type	Turbo Diesel, 4-stroke
No. of cylinders	6 in line
Bore x stroke	108 x 130mm
Total displacement	7.146cc
Compression ratio	17.6:1
Max. output	DIN6270B 197HP/145kW
Max. speed	2.300 rpm
Max. torque	667Nm at 1.500 rpm
Combustion	Direct mechanical injection
Cooling system	Fresh water, using heat exchanger, cooled exhaust manifold and turbo
	Electrical system 2 Poles, 24V
	Starter motor, 4.0kW
Alternator	55A
Gear box	Technodrive hydraulic
Max. installation angle	9° (+3° with discontinuous)
Ø Exhaust	125mm
Ø Sea-water intake	42mm
Ø Fuel intake	12mm
Ø Fuel return	12mm

**Certifications EU: RCD I (Directive 94/25/EC)**

- Item Code 022270** Solé SDZ 205 with hydraulic gearbox TM170 R=2,04 :1 - 788kg
- Item Code 022271** Solé SDZ 205 with hydraulic gearbox TM170A R=2,08 :1 - 789kg
- Item Code 022272** Solé SDZ 205 with hydraulic gearbox TM265 R=2,09 :1 - 871kg
- Item Code 022273** Solé SDZ 205 with hydraulic gearbox TM265 R=2,82 :1 - 871kg
- Item Code 022274** Solé SDZ 205 with hydraulic gearbox TM265A R=2,09 :1 - 871kg
- Item Code 022275** Solé SDZ 205 with hydraulic gearbox TM265A R=2,30 :1 - 871kg
- Item Code 022276** Solé SDZ 205 with hydraulic gearbox TM200 R=3,60 :1 - 941kg
- Item Code 022277** Solé SDZ 205 with hydraulic gearbox TM200 R=4,48 :1 - 941kg

**Parts see p. 529**

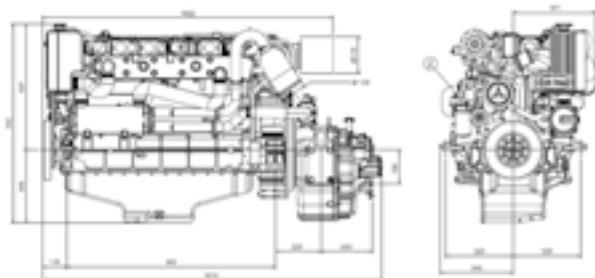



**Standard equipment:**

Flexible mounts, standard instruments panel, gearbox, wiring loom and instruction manual.

Type	Turbo Diesel Intercooler, 4-stroke
No. of cylinders	6 in line
Bore x stroke	108 x 130mm
Total displacement	7.150cc
Compression ratio	17.5:1
Max. output DIN6270B	272HP/200kW
Max. speed	2.300 rpm
Max. torque	870Nm at 1.500 rpm
Combustion system	Direct mechanical injection
Cooling system	Fresh water, using heat exchanger, cooled exhaust manifold and turbo
Electrical system	2 Poles, 24V
Starter motor,	4,0kW, alternator 55A
Gear box	Technodrive hydraulic
Max. installation angle	9° (+3° with discontinuous)
Ø Exhaust 125mm	Ø Sea-water intake 42mm
Ø Fuel intake 12mm	Ø Fuel return 12mm

**Certifications EU: RCD I (Directive 94/25/EC)**

- Item Code 022282** Solé SDZ 280 with hydraulic gearbox  
TM265 R=2,09 :1 - 841kg
- Item Code 022283** Solé SDZ 280 with hydraulic gearbox  
TM265 R=2,82 :1 - 841kg
- Item Code 022286** Solé SDZ 280 with hydraulic gearbox  
TM265A R=2,09 :1 - 841kg
- Item Code 022287** Solé SDZ 280 with hydraulic gearbox  
TM265A R=2,30 :1 - 841kg

**Parts see p. 529**

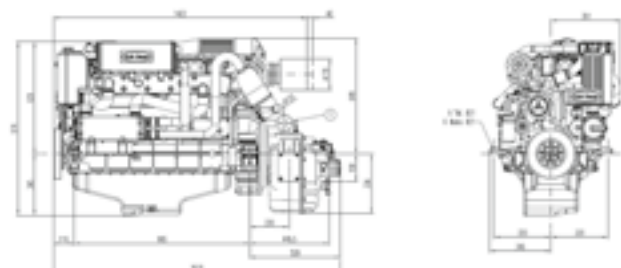

**Solé SDZ 280**  
(Based on Deutz,  
6 cylinder  
272HP / 200kW)



22.19440110

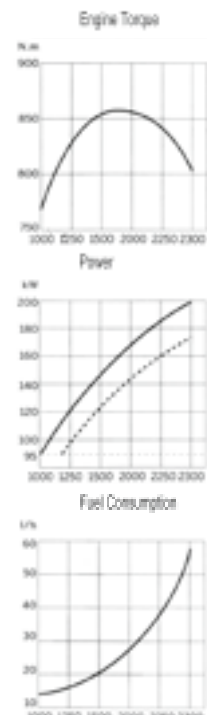



**By request!**

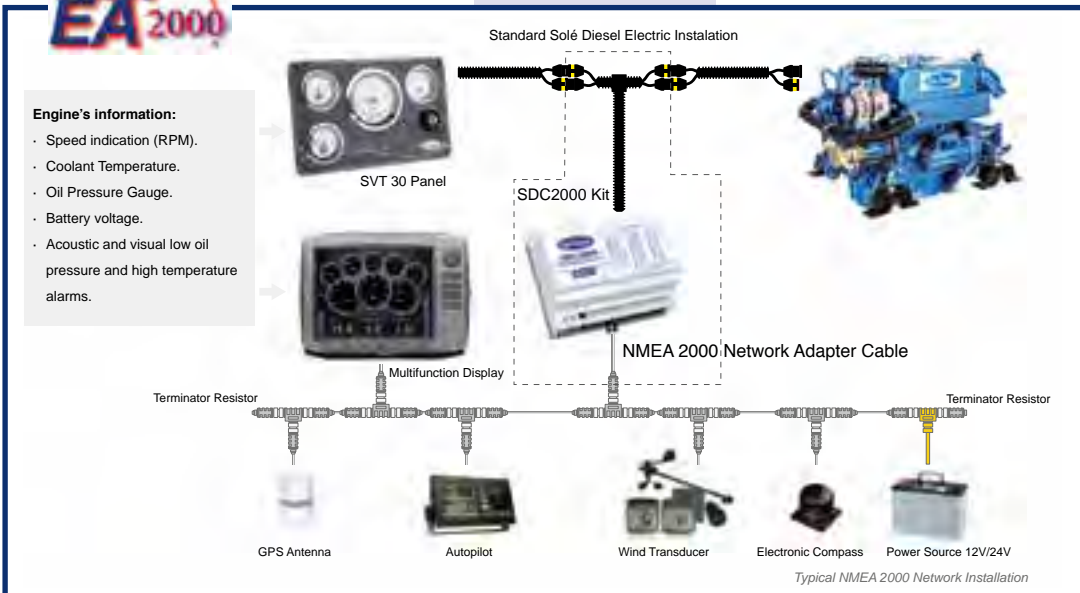

- Engine's information:**
- Speed indication (RPM).
  - Coolant Temperature.
  - Oil Pressure Gauge.
  - Battery voltage.
  - Acoustic and visual low oil pressure and high temperature alarms.

The SDC2000 Kit is an analog-to-digital-signal-converter to NMEA 2000 protocol. This product allows motor data to be displayed on a multi-functional display in a CAN-network on board.

**Features:**

- Plug and Play
- For Solé engines from 2008
- Compatible with Dual Panel Kit
- Converts to NMEA: RPM-, oil pressure, temperature- and voltage signal and audio alarm signal.



**Solé Mini 17 & 29 with adapterkits for Volvo Saildrive**

**For Solé Mini 17 & Mini 29 engines allpa delivers special adapterkits to place the waterpump on front of the engine. This is an ideal solution for sailboats!**

allpa delivers the replacement engine complete with this adapter kit:

- Code 022900** Solé Mini 17 + Kit 22.139101105  
Volvo MD 5A – 5B -7A @ Volvo Saildrive 110 S
- Code 022905** Solé Mini 17 + Kit 22.13810101  
Volvo MD 5C -7B @ Volvo Saildrive 120 S
- Code 022910** Solé Mini 29 + Kit 22.139101105  
Volvo MD 7A -11C -17C @ Volvo Saildrive 110S
- Code 022915** Solé Mini 29 + Kit 22.13810101  
Volvo MD 7B -11D -17D @ Volvo Saildrive 120 S
- Code 022920** Solé Mini 17 + Kit 22.13810100  
Volvo 2001/2002 @ Volvo Saildrive 120 B/S
- Code 022925** Solé Mini 29 + Kit 22.138.10.100  
Volvo 2002/2003 @ Volvo Saildrive 120 B/S



**Solé Mini 11, 17 & 29 adapterkit for Waterpump**

**For Solé Mini 17 & Mini 29 engines allpa delivers special adapterkits to place the waterpump on front of the engine. This is an ideal solution for sailboats!**

There are three different kits available:

- Item Code 22.13810118**  
Solé Mini 11, 17 and 29 with an old seawater pump (without splines)
- Item Code 22.13810118R**  
Solé Mini 11, 17 and 29 with a new seawater pump (with splines)
- Item Code 22.13810118S**  
Accessories kit for newly delivered Solé Mini 11, 17 and 29



**Engine support brackets specially designed for re-motorization from Volvo or Yanmar to Solé engines.**

The sets of four customized brackets come in the Solé color. The mounting holes correspond to the old holes of Volvo or Yanmar. Due to this customization, the extra costs for modification of supports and foundation will be eliminated.

See the table below, with re-motorization possibilities.

**NB. The engine always comes with the standard supports. These customized support Brackets must be ordered separately. We can not take back the standard brackets.**



Volvo Penta	Solé MINI-17	Solé MINI-29	Solé MINI-33	Solé MINI-44
2002	22.13810093	22.13910031		
2003		22.13910030	22.17210047	
2003 Turbo		22.13910030	22.17210047	
D1-13		22.13910023		
D1-20			22.17210048	
D1-30			22.17210053	
D2-40				22.17310022
MD 11C			22.17210054	
MD 2001	22.13810094			
MD 2010		22.13910012		
MD 2020		22.13910023	22.17210048	
MD 2030		22.13910023	22.17210048	
MD 2040				22.17310023
MD 7A/B	22.13810096			
MD6A	22.13810096			
MD11		22.13910034	22.17210054	
MD17/C (Largo 533)				22.17310024
MD17/C (Largo 608)				22.17310033
MD3B				22.17310036

Yanmar	Solé MINI-17	Solé MINI-29	Solé MINI-33	Solé MINI-44	Solé MINI-55
1GM	22.13810097				
1GM10	22.13810097				
1GM10V	22.13810099				
2GM20	22.13810098	22.13910033			
2GM20F	22.13810098	22.13910033			
2GM20 SD20	22.13810122				
2GM20FV	22.13810109				
2QM20H			22.17210055		
2YM15		22.13910022			
3GM 30		22.13910029			
3GM30F		22.13910029			
3GM 30 SD20		22.13910035			
3GM30FV		22.13910024			
3HM		22.13910028			
3HM 35		22.13910028			
3HMF		22.13910028			
3JH2-E			22.17210056		
3JH2-TE				22.17310028	
3JH4E SD40			22.17210059		
4JH3CE SD40				22.17310037	22.17310037
SB12/SB12G	22.13810112				
SB8/SB8G	22.13810110				

Solé  
Instrument-  
panel SVT-20

STANDARD



Item Code 22.60938130	Solé Mini- 17/29 (included)
Item Code 22.60972130	Solé Mini- 33/44/55 (included)
Item Code 22.60971135	Solé Mini- 62 (included)

Dims. 205 x 155mm

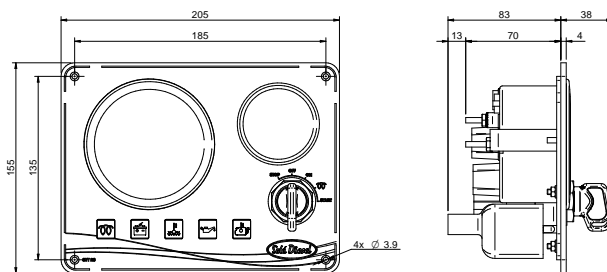

Solé  
Instrument-  
panel SVT-30

DELUXE



Item Code 22.60938132	Solé Mini- 17/29 (option)
Item Code 22.60972132	Solé Mini- 33/44/55 (option)
Item Code 22.60971138	Solé Mini- 62 (option)

Please Note: Adapter + Oil Pressure Sensor to be ordered extra!

Item Code 22.60974130	Sole Mini-74/SM-105 (included)
Item Code 22.60978100	Sole SM-82/94 (included)
Item Code 22.60982130	Sole SN85/110 (included)
Item Code 22.60994130	Sole SDZ-165/205/280 (included)

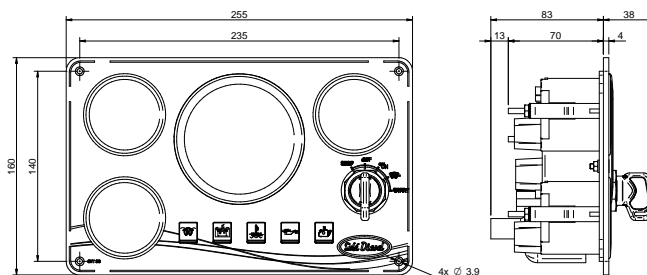

Solé  
Instrument-  
panel SVT-40

2nd PANEL



Item Code 22.60938134	Solé Mini- 17/29 (option)
Item Code 22.60972135	Solé Mini- 33/44/55 (option)
Item Code 22.60971140	Solé Mini- 62 (option)
Item Code 22.60974132	Sole Mini-74/SM-105 (option)
Item Code 22.60978131	Sole SM-82/94 (option)
Item Code 22.60982132	Sole SN85/110 (option)
Item Code 22.60994135	Sole SDZ-165/205/280 (option)

Dims. 205 x 155mm

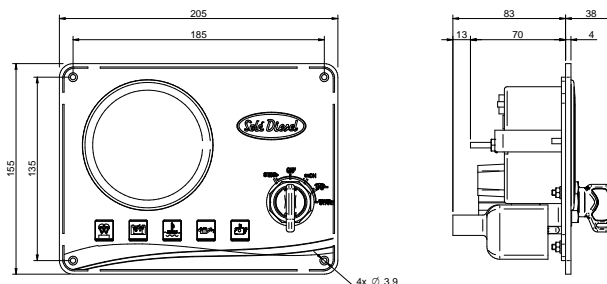

Special versions such as 24V- or mass free panels upon request.



**These Installation Kits are CE-approved!**

**allpa bespoke installation kits:**

The length of control cables and the several hoses do not influence the fixed set price. Additional price is charged for an extra big or stainless steel fuel tank, an eventual folding propeller, an A-Flex CV-shaft with thrust bearing, an extra motor control unit for dual station, a longer propeller shaft and/or a bigger shaft diameter and/or a longer stern tube than standard.

Installation of an air vent into the exhaust and cooling system is essential if the water injection point is only 150mm above the waterline or below.



**An Installationkit consists of:**

- Single lever dual action engine control, side mount
- Control cables, set of two
- Battery selector switch
- Battery box
- Water lock
- Exhaust hose
- Skin fitting for exhaust
- Set stainless steel hose clamps
- Cooling water strainer kit complete with hoses
- Fuel tank with suction- and return lines
- Fuel deck entry with hose
- Stainless steel propeller shaft with nut and anode
- Inner bearing
- Outer bearing or shaft support strut
- Brass-, glassfiber or aluminum stern tube
- Centa flexible shaft coupling



**Bespoke Installation Kits for Marine Diesel Engines**

**Customization delivered!**



<b>allpa® Bespoke Marine Engine Installation Kits CE-approved</b>			
Item Code	Description	Power	Features
SETM17	allpa Mini 11/17	up to ± 20HP	Shaft Ø25x1000mm, tank 33L
SETM29	allpa Mini 29	up to ± 30HP	Shaft Ø25x1500mm, tank 33L
SETM33	allpa Mini 33	up to ± 40HP	Shaft Ø25x1500mm, tank 33L
SETM44	allpa Mini 44	up to ± 50HP	Shaft Ø30x1500mm, tank 33L
SETM55	allpa Mini 55	up to ± 60HP	Shaft Ø30x1500mm, tank 53L
SETM62	allpa Mini 62/SK 60	up to ± 70HP	Shaft Ø35x1500mm, tank 53L





# SOLÉ FAST MOVING PARTS



Solé Maintenance Kits include:  
 Impeller, Water Pump Gasket,  
 Fuel Filter, Oil Filter and Plastic Tool Case

Maintenance Kits for:

Item Code	22.13840110	Mini 17, 29, 33, 44
Item Code	22.17740110	Mini 55
Item Code	22.17140110	Mini 62/G
Item Code	22.1A040103	SK-60
Item Code	22.17440110	Mini 74
Item Code	22.17840110	SM-82
Item Code	22.17940110	SM-94
Item Code	22.17540110	SM-105/L
Item Code	22.18240110	SN-110
Item Code	22.19440110	SDZ-165, 205, 280
Item Code	22.A0105000	Solé 5l Motor Oil Multigrade 15W40 ACEA: E5/E3, API CH-4
Item Code	22.A0201000	Solé 1l ATF-Oil, Dexron II-D, for mechanical gearboxes TMC-series
Item Code	22.MA000001	Solé 5l Antifreeze Coolant Liquid 50%

## Solé Service Items

# SOLÉ DIESEL FAST MOVING PARTS



SOLÉ Engine	Power	Rocker Cover	Oil Filter	Fuel Filter	V-Belt Standard (depending on alternator type)	Impeller	Water Pump Gasket	Air Filter (Element)	Anodes
MINI 1/2/3	6pk	22.12121044	22.12114082	22.11114095	22.12117043	22.32111008R	22.32111003	22.13810073*	
MINI 10	9pk	22.13721010	22.13124051	22.13124020	22.13717013	22.32111008R	22.32111003	22.13810073*	
MINI 11	11pk	22.13821010	22.13124051	22.13114022	22.13821028	22.31211008R	22.31211003	22.13810073*	
MINI 14	13pk	22.13521010	22.13124051	22.13124020	22.13521028	22.31211008R	22.31211003	22.13810073*	
MINI 17	16pk	22.13821010	22.13124051	22.13114022	22.13821228	22.31211008R	22.31211003	22.13810073*	22.13811043
MINI 18	17pk	22.13121010	22.13124051	22.13124020	22.13117015	22.32111008R	22.32111003	22.13810073*	
MINI 23	20pk	22.13621010	22.13124051	22.13114022	22.13221028	22.31211008R	22.31211003	22.13810073	
MINI 26	25pk	22.13921010	22.13124051	22.13114022	22.13821028	22.31211008R	22.31211003	22.13810073	
MINI 29	27pk	22.17621010	22.13124051	22.13114022	22.13821228	22.31211008R	22.31211003	22.13810073	22.13811043
MINI 32	28pk	22.13221010	22.13124051	22.13124020	22.13221028	22.31211008R	22.31211003	22.13810073	
MINI 33	32pk	22.17221010	22.13124051	22.13114022	22.13421028	22.31211008R	22.31211003	22.13810073	22.18011031
MINI 34	31pk	22.13221010	22.13124051	22.13114022	22.13421028	22.31211008R	22.31211003	22.13810073	
MINI 44	42pk	22.17321010	22.13124051	22.13114022	22.13421028	22.31211008R	22.31211003	22.13810073	22.18011031
MINI 48	45pk	22.17021010	22.13924051	22.13114022	22.17021028	22.31211008R	22.31211003	22.13810073	
MINI 50	50pk	22.16110026	22.16124051	22.12814028	22.16127013	22.35111008R	22.35211003		
MINI 55	52pk	22.17321010	22.13124051	22.13114022	22.13421028	22.35111008R	22.35211003	22.17710012	22.18011031
MINI 62	60pk	22.17121010	22.13924051	22.17114022	22.15217103	22.34711008R	22.34711003	22.17110030	22.18011031
MINI 74	70pk	22.17421010	22.17424051	22.17414022	22.17521028	22.34711008R	22.34711003	22.17410031	22.18011031
SK 60	82pk	22.1A021009	22.1A024051	22.13114022	22.17117020	22.34711008R	22.34711003	22.17710012	
SM 75	72pk	22.18021010	22.17524051	22.17114022	22.18021028	22.34711008R	22.34711003	22.18010031	22.18011031
SM 90	88pk	22.18021010	22.17524051	22.12814028	22.18021028	22.34711008R	22.34711003	22.18010031	22.18011031
SM 105	95pk	22.17521010	22.17524051	22.17414022	22.17521028	22.34711008R	22.34711003	22.17410030	22.18011031
SN 85	83pk	22.18221010	22.18524051	22.18224022	22.18221028	22.34711008R	22.34711003	22.17110030	
SN 110	103pk	22.18221010	22.18524051	22.18224022	22.18221028	22.34711008R	22.34711003	22.17110030	
SM 82	82pk	22.17421010	22.17424051	22.17114022	22.17521028	22.34711008R	22.34711003	22.17810012	22.18011031
SM 94	94pk	22.17421010	22.17424051	22.17114022	22.17521028	22.34711008R	22.34711003	22.17910012	22.18011031
SFN 100	100pk	22.19021010	22.19024051	486470	22.19017025	22.34711008R	22.34711003	22.19010031	

\* = Kompleet filter art. 22.13810074



# R-Serie 200HP / 147kW

## Engine

- Cast iron engine cylinder block
- Aluminum head
- Nine balance weight crankshaft
- Balance shaft
- Oil cooled pistons
- In-line 4, 16-valve DOHC
- Hydraulic lash adjusters
- Integrated water jacket
- Timing / drive belt auto tensioner
- Single serpentine belt system
- Drive belt auto tensioner

## Engine Mounting

- Adjustable engine mounts

## Lubrication System

- Easily exchangeable oil filter cartridge
- Electric oil extraction pump
- Seawater cooled transmission oil cooler

## Fuel System

- Common Rail Direct Injection (CRDi)-Solenoid injectors
- New Solenoid Injectors with 2,000 bar
- Fuel filter with sensor detecting water in fuel
- Electric fuel pump
- Dual pressure control valve
- Low and high pressure fuel pumps

## Electrical System

- 12V system and 180A alternator
- Auxiliary engine stop button
- Glow plugs for a trouble-free cold start
- NMEA2000 Converter (Optional)
- Electronic control system (Optional)

## Cooling System

- Seawater pump driven directly from the camshaft
- Seawater cooled intercooler, heat exchanger
- Connector prepared for cabin heater
- Corrosion resistant material for the seawater circuit
- Easily exchangeable rubber impeller

## Engine Operation Indicator (EOI)

- Engine self protection and diagnosis
- Displays CAN information
- Displays engine diagnostic error codes
- Audible alarm and control lamps

## Air Inlet system

- Oil wetted and reusable air filter
- Crankcase gases vented into the air inlet

## Exhaust System

- Thermal insulated exhaust manifold
- Seawater cooled exhaust elbow

## Turbocharger

- E-VGT, Electronic Variable Geometry Turbocharger

## Engine Coupler

- Life-long and rattle free rubber roller coupler
- Torsion spring type for water jet

## Emissions

- IMO NOx Tier 2 and EU RCD compliant

## Noise Level

- EU RCD compliant



Extra



Extra



**HYUNDAI SEASALL**  
NEW THINKING. NEW POSSIBILITIES.

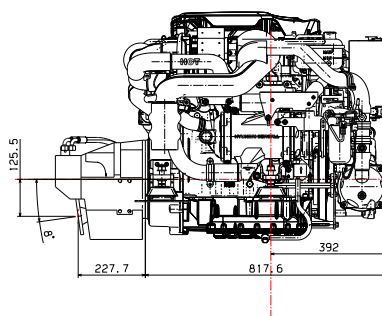
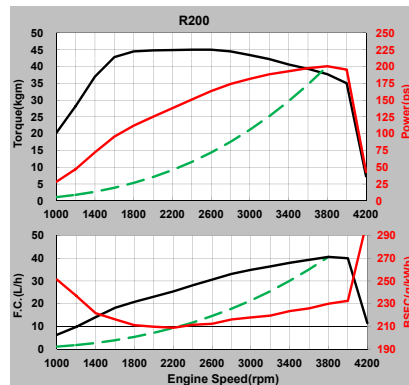



## V6 S-Series 270HP / 199kW

### Engine

- Cast iron engine cylinder block
- Aluminum head
- Nine balance weight crankshaft
- Oil cooled pistons
- V6, 24-valve DOHC
- Hydraulic lash adjusters
- Integrated water jacket
- Low noise duplex timing chain
- Single serpentine belt system
- Drive belt auto tensioner

### Engine Mounting

- Adjustable engine mounts

### Lubrication System

- Easily exchangeable oil filter cartridge
- Electric oil extraction pump
- Seawater cooled oil cooler
- Chain drive engine oil pump

### Fuel System

- Common Rail Direct Injection (CRDi)-Piezo injectors
- Fuel filter with sensor detecting water in fuel
- Electric fuel pump
- Dual pressure control valve
- Low and high pressure fuel pumps

### Electrical System

- 12V system and 150A alternator
- Auxiliary engine stop button
- Glow plugs for a trouble-free cold start
- NMEA2000 Converter (Optional)
- 2 Pole system (Optional)
- Electronic control system (Optional)

### Cooling System

- Seawater pump driven directly from the camshaft
- Seawater cooled intercooler, heat exchanger
- Auxiliary connector prepared for cabin heating
- Corrosion resistant material for the seawater circuit

### Engine Operation Indicator (EOI)

- Engine self protection and diagnosis
- Displays CAN information
- Displays engine diagnostic error codes
- Audible alarm and control lamps

### Air Inlet system

- Oil wetted and reusable air filter
- Crankcase gases vented into the air inlet
- Intake silencer (Optional)

### Exhaust System

- Engine coolant cooled exhaust manifold
- Thermal insulated exhaust manifold
- Seawater cooled exhaust elbow
- Seawater cooled Hi-Riser (Optional)

### Turbocharger

- E-VGT, Electronic Variable Geometry Turbocharger

### Engine Coupler

- Life-long and rattle free rubber roller coupler
- Torsion spring type for water jet

### Emissions

- EPA Tier 2, IMO, BSO and RCD compliant

### Noise Level

- 69.3dB (RCD Standard 75dB)



Extra

Extra



**HYUNDAI SEASALL**  
NEW THINKING. NEW POSSIBILITIES.

• S2505 / S2509P / S2501 Performance Curves

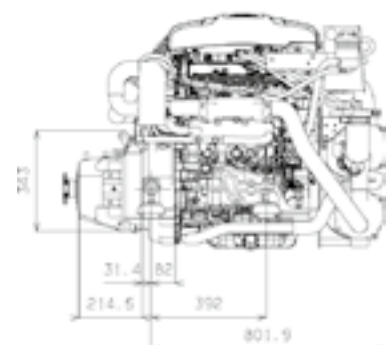
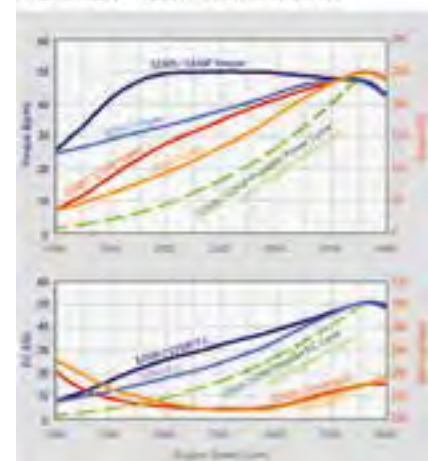



**allpa**  
marine equipment





**TECHNODRIVE TMC 40P** marine gearbox unit is equipped with conical clutches mechanically operated, actuated by a servo-system; gears are specially constructed for quiet operation and bearing are amply proportioned.

Forward Ratio	1,45	2,00	2,60
Reverse Ratio	2,13	2,13	2,13
Max. Input Torque (Nm)			
Pleasure	115	90	70
Commercial	95	70	50
Max.input power			
Pleasure	26kW		
Commercial	21kW		
Max. input power	4500 rpm		
Dry weight	8,8kg		
Oil quantity	0,20L		
Oil type	ATF		



When ordering please specify length of input shaft 45 or 75mm.

TMC 40P

**TMC 40 P:**

This mechanical marine gearbox is suitable for righthanded propellers. For left-handed propellers one must use reverse as forward. Max. Input Power in reverse is 33% of rated power in forward.

Accessories: see p. 548-553



**Dimensions:**

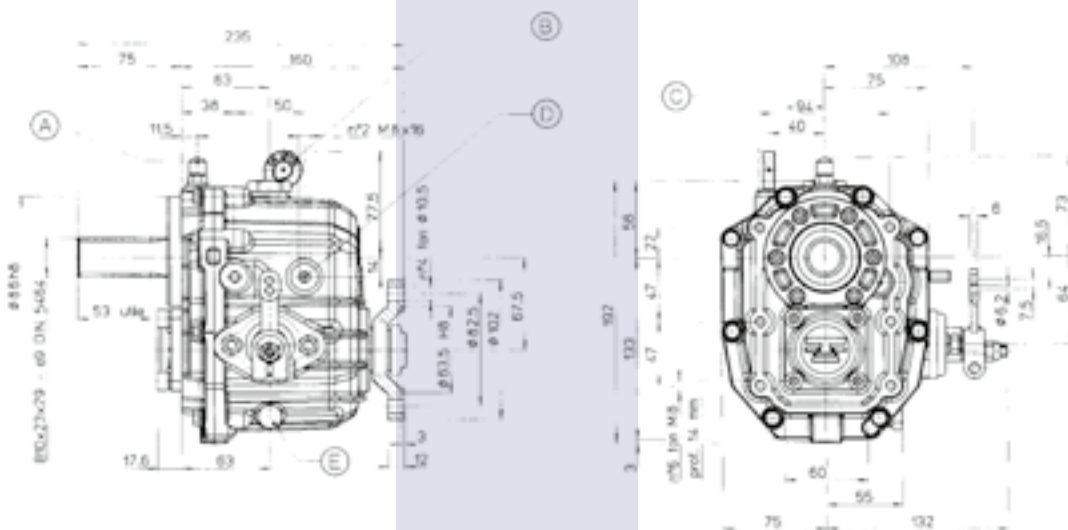

- A: Breather Plug
- B: Filling Plug
- C: Oil level dip stick
- D: Holes for control cable bracket
- E: Oil drain plug

Max. Engine Power (kW) \_\_\_\_\_ x 7120 = Max. Max. Prop. Shaft Torque (Nm)

Max. Engine rpm (N)

Units: 1kgm = 9,807Nm, 1 PS = 0,736kW, 1kg = 9,807 N, 1 Kn = 1000 N

**Calculation Max. Propeller Shaft Torque**



TMC 60P

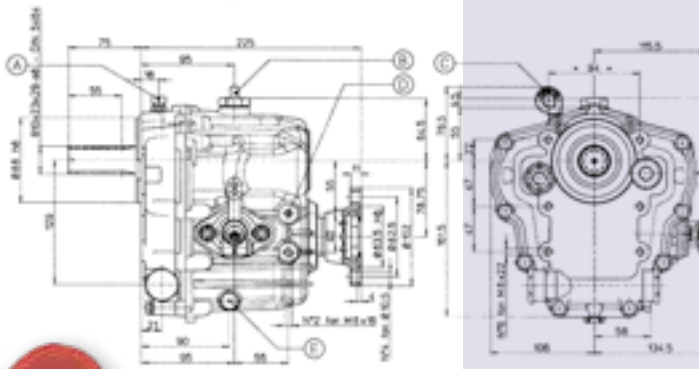

**TMC 60P Marine Gearbox**

**Technical Data:**

Mechanically operated conical clutches with servo-system

<b>Forward ratios</b>	<b>1,55</b>	<b>2,00</b>	<b>2,45</b>	<b>2,83</b>
Reverse ratios	2,00	2,00	2,45	2,45
Max. torque (Nm):				
Pleasure	170	150	120	100
Commercial	120	110	90	75
Max. input speed	5000 rpm			
Max. input power:				
Pleasure	60kW			
Commercial	45kW			
Oil Quantity	0,65l			
Oil type	ATF			
Dry Weight	14kg			

For left-handed propellers the reverse must be used as forward. The reverse capacity is limited as follows:

**TMC 60P R = 1,55:** 80% of listed rating at R=2,00

**TMC 60P R = 2,00 & 2,45:** 80% of listed ratings

**TMC 60P R = 2,83:** 80% of listed rating at R=2,45

Accessories: Oil cooler, Flanges, Cable Brackets et cetera:

**Please see p. 548-553**



TMC 60A

**TMC 60A Marine Gearbox**

**Technical Data:**

Mechanically operated conical clutches with servo-system

Helical gears, case hardened and cemented

Down angled output shaft: 7°

<b>Forward ratios:</b>	<b>2,00</b>	<b>2,45</b>
Reverse ratios:	2,17	2,17
Max. Torque (Nm):		
Pleasure:	130	130
Commercial:	91	91
Max. input speed	4500 rpm	4500 rpm
Max. input power:		
Pleasure	52kW	
Commercial	39kW	
Oil Quantity	0,60l	
Oil Type	ATF	
Dry Weight	15kg	

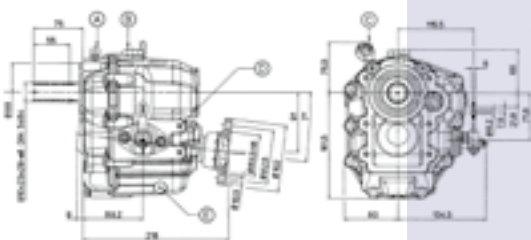

A: Breather Plug

B: Filling Plug

C: Oil Level Dip Stick

D: Holes for Control Cable Bracket

E: Oil Drain Plug



For left-handed propellers the reverse must be used as forward. The reverse capacity is limited as follows:

**TMC 60A R = 2,00 and 2,45:** 33% of forward ratings.

Accessories: Oil cooler, Flanges, Cable Brackets etcetera:

**Please see p. 548-553**

**TECHNODRIVE TMC 260** marine gearbox unit is equipped with conical clutches mechanically operated, actuated by a servo-system; gears are specially constructed for quiet operation and bearings are amply proportioned.

Forward Ratio	1,54	2,00	2,47	2,88
Reverse Ratio	2,00	2,00	2,47	2,47
Max. Input Torque (Nm)				
Pleasure	260	260	210	180
Commercial	190	190	140	110
Max. Input Power				
Pleasure	84kW			
Commercial	61kW			
Max. Input Speed	5000rpm			
Dry Weight	18kg			
Oil Quantity	1,20l			
Oil Type	ATF			

**TMC 260M:**

These mechanical gearboxes are suitable for right-handed propellers. For left-handed propellers the reverse must be used as forward. NOTE: Ratings are full power forward.

- The reverse capacity is limited as follows:

**TMC 260M R = 1,54 & 2,00:** 80% of listed ratings

**TMC 260M R = 2,47 & 2,88:** 80% of ratio 2,47 listed ratings

The reduction ratios 2,00 and 2,47 are very suitable for left-hand and right-hand propeller rotation in " ahead" full power, making TMC 260 particularly well suited to twin engine applications.

For operation under arduous conditions, especially when The reverse is used as the main direction of travel, we suggest a cooling system. **See accessories on p. 548-553**



**TMC 260**

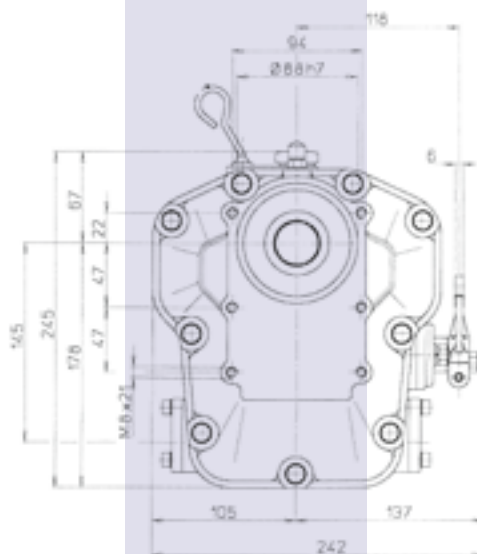
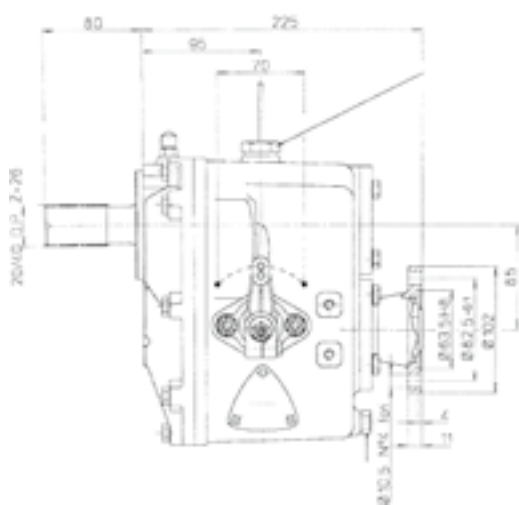

- A: Breather Plug
- B: Filling Plug
- C: Oil level dip stick
- D: Holes for control cable bracket
- E: Oil drain plug



TM 345

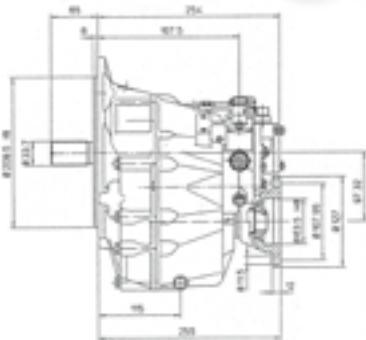

**TM 345 Marine Gearbox**

**Technical data**

- Hydraulic multi-plate clutch
- Identical performance forward and reverse
- Case hardened and cemented helical gears
- Lubricating pressure: 0,5 - 1,5bar
- Operating pressure: 24bar
- Oil content: 1,5l
- Weight: 25kg
- Ratios: 1,54 - 2,00 - 2,47 : 1
- Standard SAE-7 flanging

Ratio	max. torque pleasure	max. torque commercial	max. rpm
1,54:1	35kgm	---	4500
2,00:1	28kgm	---	4500
2,47:1	21kgm	---	4500

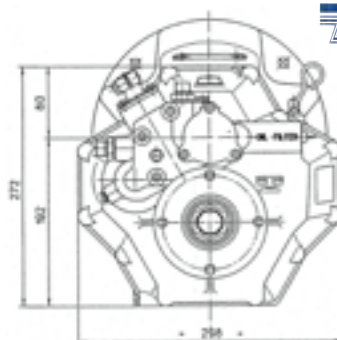

TM 345A

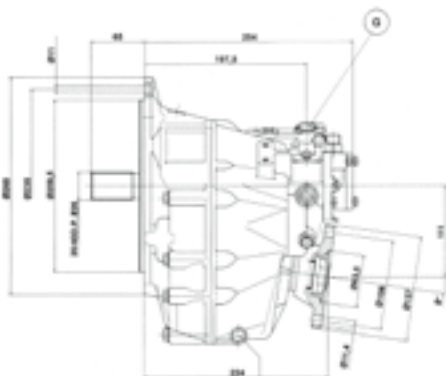

**TM 345A Marine Gearbox**

**Technical data**

- Hydraulic multi-plate clutch
- Identical performance forward and reverse
- Case hardened and cemented helical gears
- Lubricating pressure: 0,5 - 1,5bar
- Operating pressure: 24bar
- Oil content: 1,5l
- Weight: 25kg
- Ratios: 1,54 - 2,00 - 2,47 : 1
- Down angle output shaft: 8°
- Standard SAE-7 flanging

Ratio	max. torque pleasure	max. torque Commercial	max. rpm
1,54:1	35kgm	---	4500
2,00:1	28kgm	---	4500
2,47:1	21kgm	---	4500

Accessories: see p. 548-553

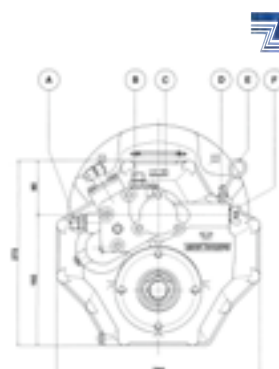

**TM 93 Marine Gearbox**

**Technical data**

- Hydraulic multi-plate clutch
- Identical performance forward and reverse
- Case hardened and cemented helical gears
- Lubricating pressure: 0,5 - 1,5bar
- Operating pressure: 24bar
- Oil content: 2,0l
- Weight: 51kg
- Ratios: 1,51 - 2,09 - 2,40 - 2,77 : 1

Ratio	max. torque pleasure	max. torque commercial	max. rpm
1,51:1	52kgm	40kgm	4500
2,09:1	42kgm	35kgm	4500
2,40:1	40kgm	31kgm	4500
2,77:1	35kgm	27kgm	4500

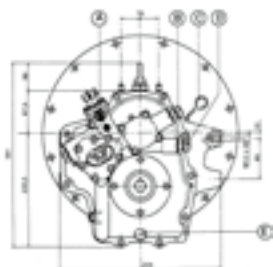

TM 93

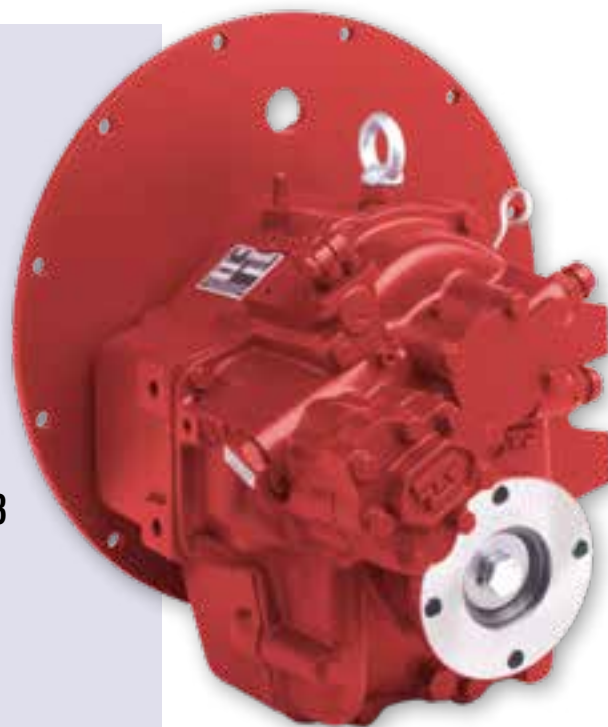

**TM 93A Marine Gearbox**

**Technical Data**

- Hydraulic multi-plate clutch
- Identical performance forward and reverse
- Case hardened and cemented helical gears
- Lubricating pressure: 0,5 - 1,5bar
- Operating pressure: 24bar
- Oil content: 2,0l
- Weight: 51kg
- Ratios: 1,51 - 2,09 - 2,40 : 1
- Down angle output shaft: 8°

Ratio	max. torque pleasure	max. torque commercial	max. rpm
1,51:1	48kgm	37kgm	4500
2,09:1	40kgm	31kgm	4500
2,40:1	35kgm	27kgm	4500

Accessories: see p. 548-553

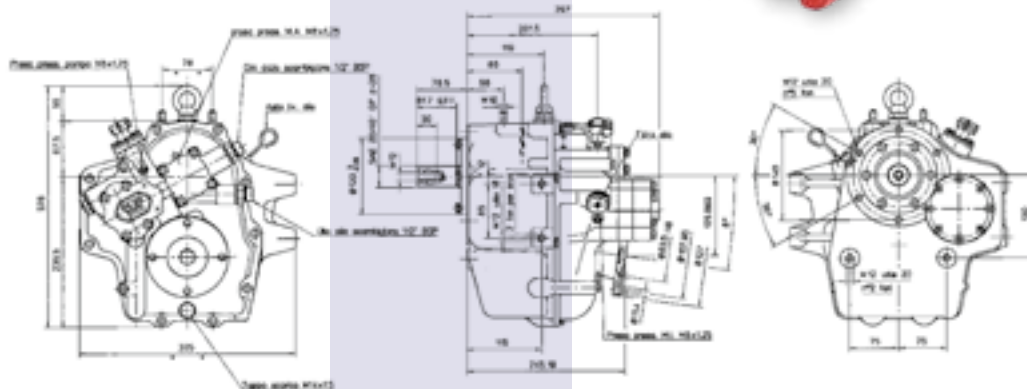

TM 93A

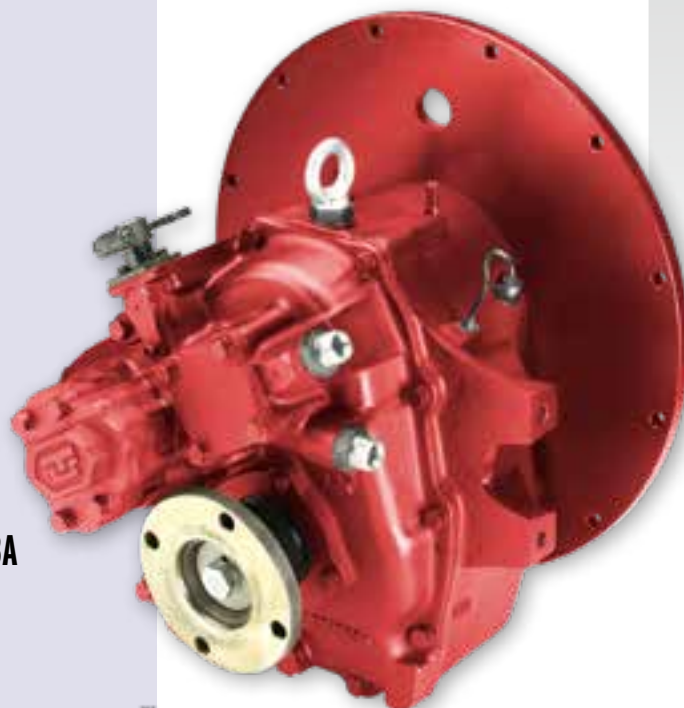

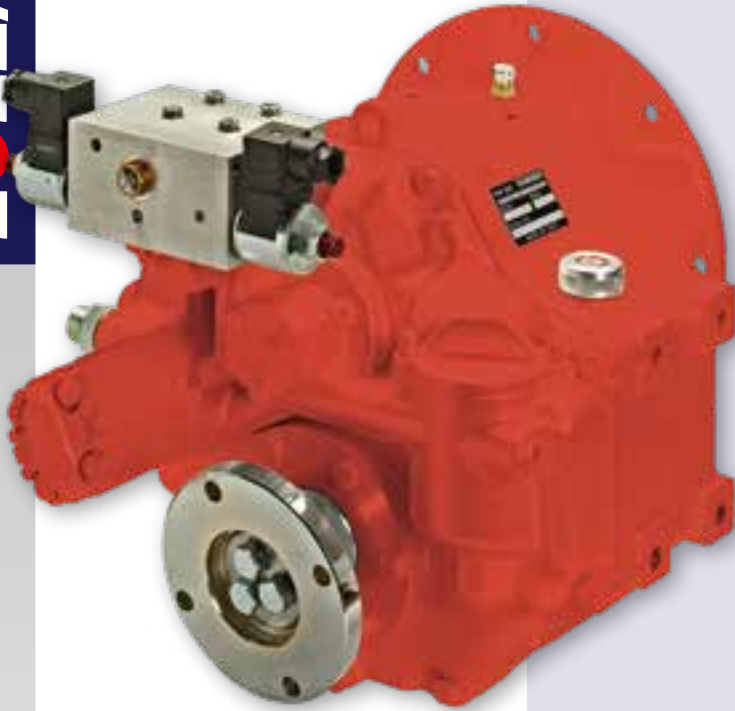

TM 485A1

**TM 485A1 Marine Gearbox**

**Technical Data**

- Hydraulic multi-plate clutch
- Identical performance forward and reverse
- Case hardened and cemented helical gears
- Lubricating pressure: 0,5 - 1,5bar
- Operating pressure: 24bar
- Oil content: 2,6l
- Weight: 36kg
- Ratios: 1,51-2,09-2,40 :1
- Down angle output shaft: 8°

**TM 485A1 Accessories:**

- SAE 3 Flange
- SAE 2 Flange
- Torsional Couplings
- Propeller Shaft Flange
- Heat Exchanger Kit
- Cable Bracket
- Trolling Valve
- Electric Shift

ratio	max. torque pleasure	max. torque commercial	max. rpm.
1.51:1	49kgm	32kgm	4500
2.09:1	49kgm	32kgm	4500
2.40:1	43kgm	28kgm	4500

Accessories: see p. 548-553

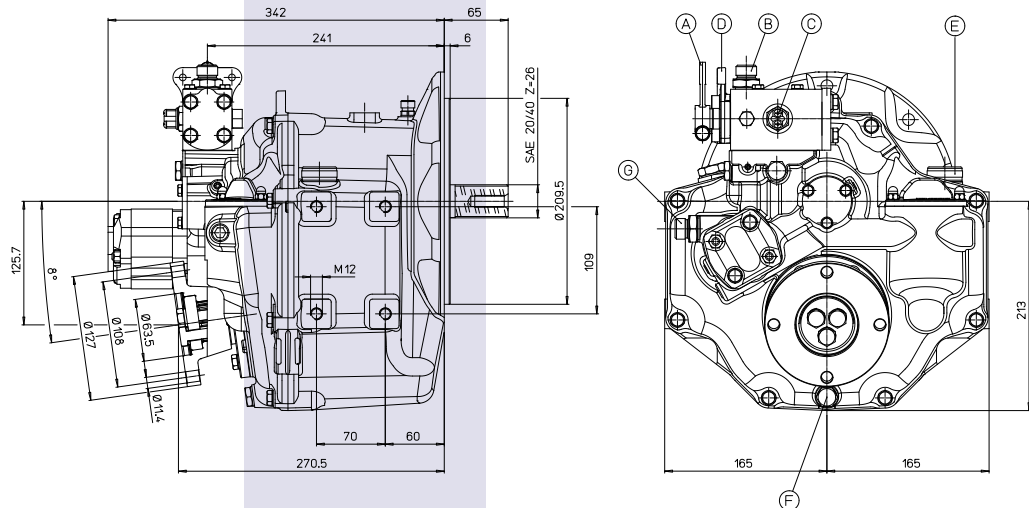





TM 170

**TM 170 Marine Gearbox**

**Technical data**

- Hydraulic multi-plate clutch
- Identical performance forward and reverse
- Case hardened and cemented helical gears
- Lubricating pressure: 0,5 - 1,5bar
- Operating pressure: 24bar
- Oil content: 2,5l
- Weight: 75kg
- Ratios: 1,51 - 2,04 - 2,50 - 2,94 : 1

Ratio	max. torque pleasure	max. torque commercial	max. rpm
1,50:1	75kgm	57kgm	4500
2,04:1	75kgm	57kgm	4500
2,50:1	60kgm	45kgm	4500
2,94:1	51kgm	38kgm	4500

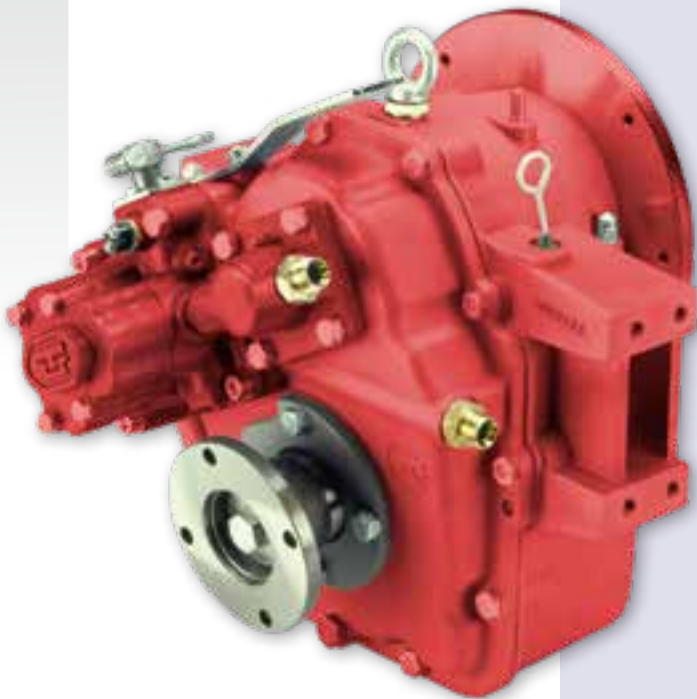
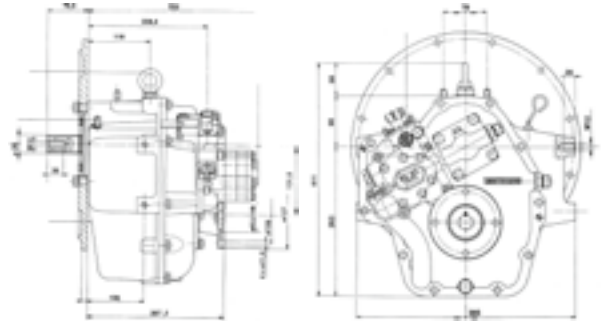

TM 880A

**TM 880A Marine Gearbox**

**Technical data**

- Hydraulic multi-plate clutch
- Identical performance forward and reverse
- Case hardened and cemented helical gears
- Lubricating pressure: 0,5 - 1,5bar
- Operating pressure: 24bar
- Oil content: 3,7l
- Weight: 54kg
- Ratios: 1,53 - 2,08 - 2,60 : 1
- Down angle output shaft: 10°

Ratio	max. torque pleasure	max. torque commercial	max. rpm
1,53:1	88kgm	57kgm	4000
2,08:1	88kgm	57kgm	4000
2,60:1	61kgm	32kgm	4000

Accessories: see p. 548-553

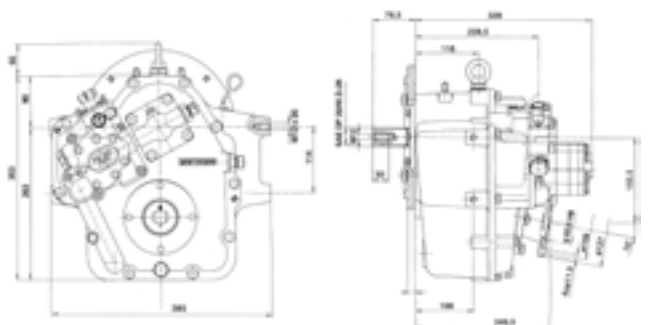



### TM 265 Marine Gearbox

#### Technical data

- Hydraulic multi-plate clutch
- Identical performance forward and reverse
- Case hardened and cemented helical gears
- Lubricating pressure: 0,5 - 1,5bar
- Operating pressure: 24bar
- Oil content 5,5l
- Weight: 165kg
- Ratios: 1,17 - 1,50 - 2,09 - 2,82 : 1

Ratio	max. torque pleasure	max. torque commercial	max. rpm.
<b>1,17:1</b>	106kgm	83kgm	3000
<b>1,50:1</b>	106kgm	83kgm	3000
<b>2,09:1</b>	106kgm	83kgm	3000
<b>2,82:1</b>	106kgm	83kgm	3000

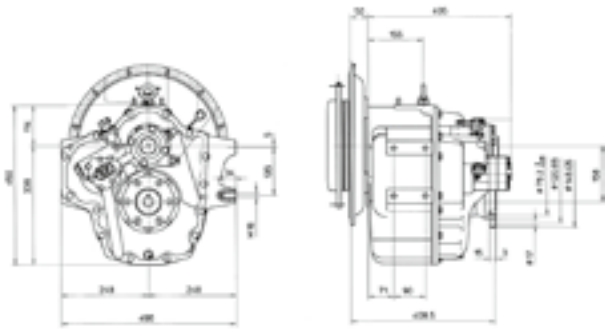

TM 265

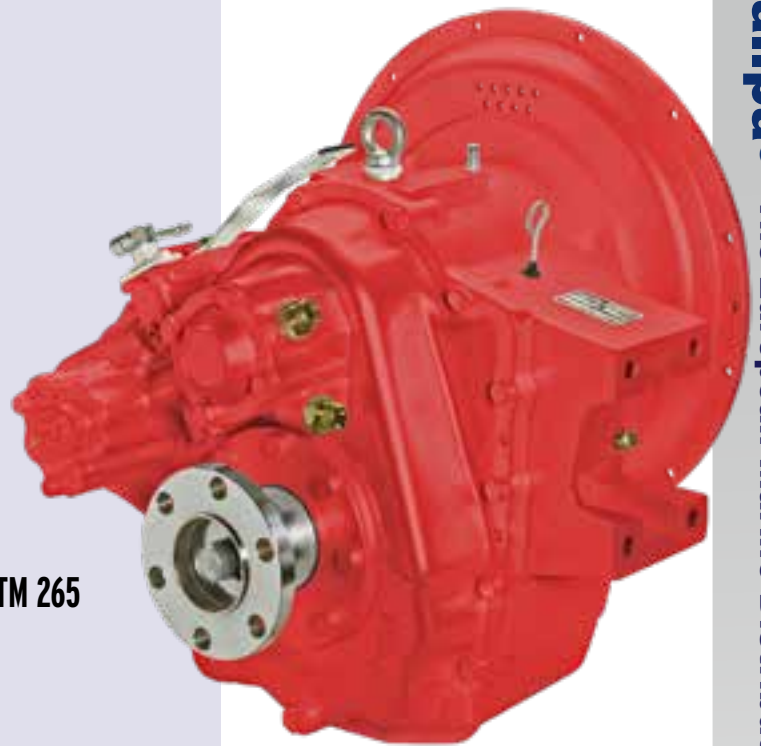

Also available with  
PTO (SAE-B/Z-15)  
Max. Torque 195Nm

### TM 265A Marine Gearbox

#### Technical data

- Hydraulic multi-plate clutch
- Identical performance forward and reverse
- Case hardened and cemented helical gears
- Lubricating pressure: 0,5 - 1,5bar
- Operating pressure: 24bar
- Oil content: 5,5l
- Weight: 165kg
- Ratios: 1,44 - 2,09 - 2,30 : 1
- Down angle output shaft: 7°

Ratio	max. torque pleasure	max. torque commercial	max. rpm.
<b>1,44:1</b>	106kgm	94kgm	3000
<b>2,09:1</b>	98kgm	87kgm	3000
<b>2,30:1</b>	89kgm	79kgm	3000

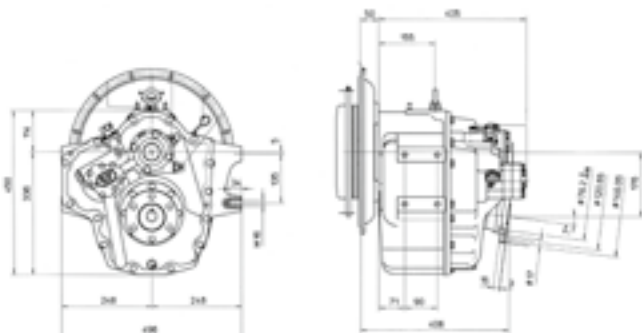

TM 265A

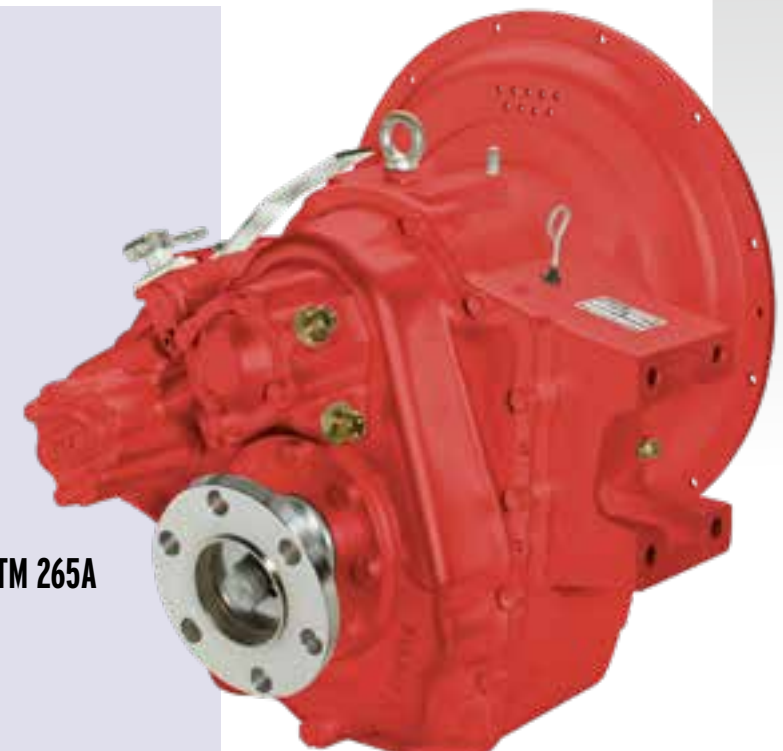

Also available with  
PTO (SAE-B/Z-15)  
Max. Torque 195Nm

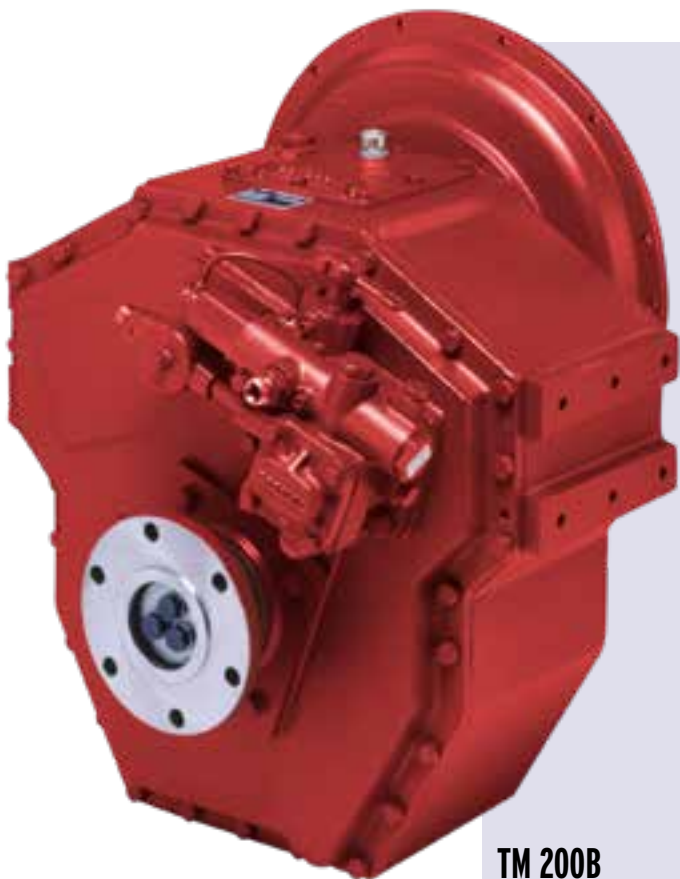

TM 200B

### TM 200B Marine Gearbox

#### Technical data

- Hydraulic multi-plate clutch
- Identical performance forward and reverse
- Case hardened and cemented helical gears
- Lubricating pressure: 0,5 - 1,5bar
- Operating pressure: 14-18bar
- Oil content: 13l
- Weight: 235kg
- Ratios: 3,60 - 4,48 : 1

Ratio	max. torque pleasure	max. torque commercial	max. rpm.
3,60:1	61kgm	61kgm	3000
4,48:1	61kgm	61kgm	3000

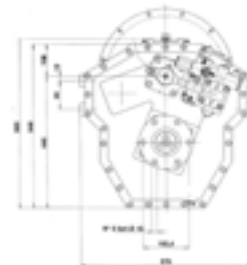
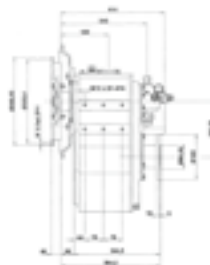

TM 360

### TM 360 Marine Gearbox

#### Technical data

- Hydraulic multi-plate clutch
- Identical performance forward and reverse
- Case hardened and cemented helical gears
- Lubricating pressure: 0,5 - 1,5bar
- Operating pressure: 24bar
- Oil content: 11l
- Weight: 415kg
- Ratios: 3,00 - 3,50 - 4,00 - 5,00 : 1

Ratio	max. torque pleasure	max. torque commercial	max. rpm.
3,00:1	---	118kgm	2600
3,50:1	---	118kgm	2600
4,00:1	---	118kgm	2600
5,00:1	---	118kgm	2600

Accessories: see p. 548-553

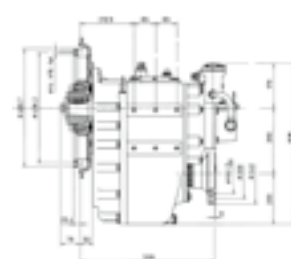
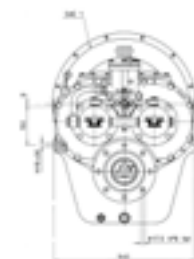

**TM 1200A Marine Gearbox**

**Technical data**

- Max. 400 Hp (294kW)
- Lubricating pressure: 0,5 - 1,5bar
- Operating pressure: 24bar
- Oil content: 6,5l
- Weight: 120kg
- Ratios: 1,44 - 2,09 - 2,30 : 1
- Down angle output shaft: 7°
- Standard with Electric Shift

**Accessories for TM1200A:**

- SAE-3 Flange
- SAE-2 Flange
- SAE-1 Flange
- Couplings 11-1/2"
- Couplings 14"
- Adapter for output flange
- Gearbox supports
- PTO

Ratio	max. torque pleasure	max. torque commercial	max. rpm.
1.44:1	140kgm	84kgm	3200
2.00:1	140kgm	84kgm	3200
2.30:1	140kgm	71kgm	3200

Accessories: see p. 548-553

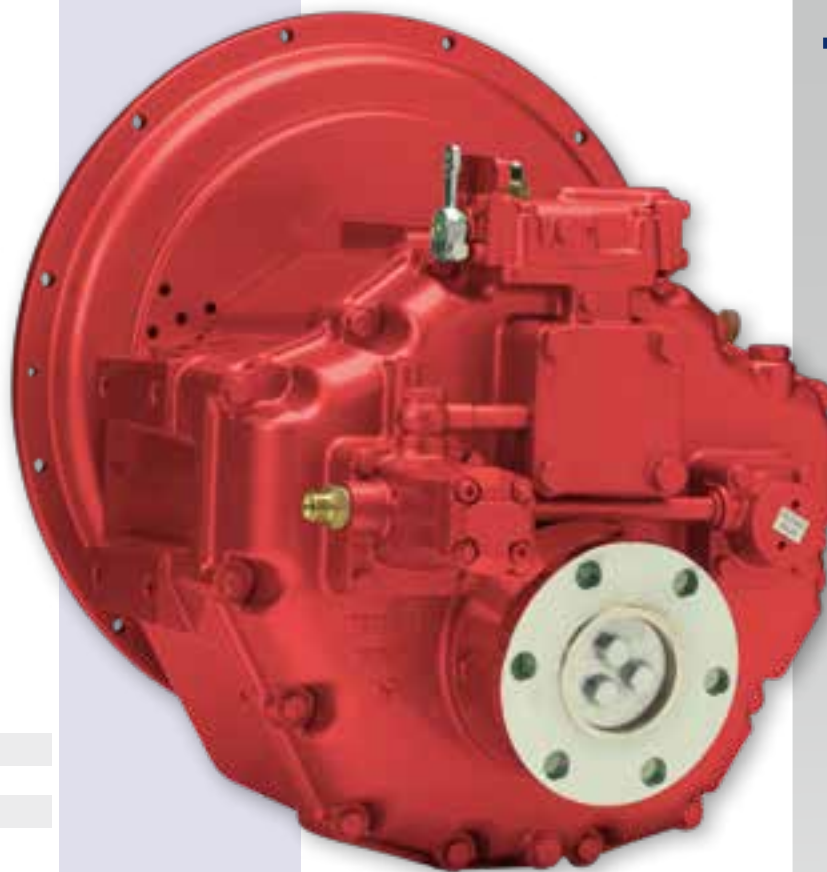

TM 1200A

Also available with  
PTO (SAE-B/Z-15)  
Max. Torque 195Nm

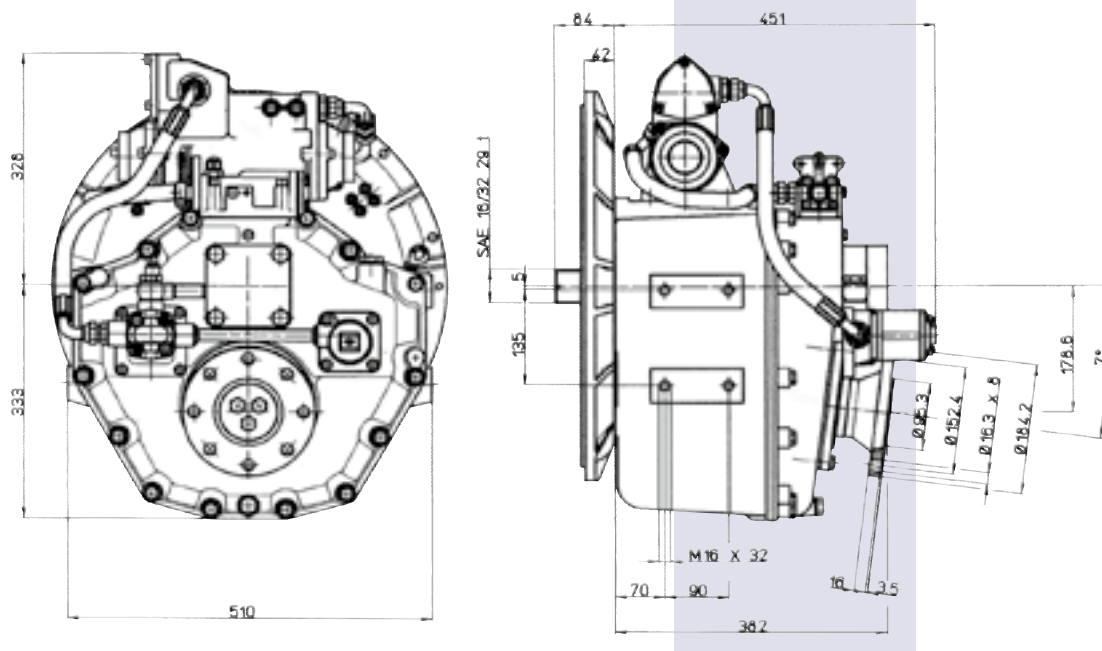

## Technodrive Marine Reversing Gears

Mechanical Gearboxes:	Ratio	Pleasure Duty at RPM:			Intermediate Duty at RPM:			Continuous Duty at RPM:			Max RPM	Weight kg
		2800	3000	3600	2800	3000	3600	1800	2300	2600		
		HP	HP	HP	HP	HP	HP	HP	HP	HP		
TMC40P	1,45	35	35	35	35	35	35	24	31	35	4500	8,8
	2,00	35	35	35	30	32	35	18	23	25	4500	
	2,60	27	29	35	24	25	30	13	16	18	4500	
TMC60P	1,55	67	72	80	57	61	73	30	39	44	5000	14
	2,00	59	63	76	50	53	64	28	35	40	5000	
	2,45	47	51	61	44	47	56	23	29	33	5000	
	2,83	39	42	51	34	36	43	19	24	27	5000	
TMC60A (7°)	2,00	-	56	66	43	47	-	23	30	-	4500	15
	2,45	-	56	66	43	47	-	23	30	-	4500	
TMC260	1,54	102	109	113	87	93	111	48	61	69	5000	18
	2,00	102	109	113	87	93	111	48	61	69	5000	
	2,47	83	88	106	70	75	90	35	45	51	5000	
	2,88	71	76	91	60	64	77	28	35	40	5000	
Hydraulic Gearboxes:	Ratio	Pleasure Duty at RPM:			Intermediate Duty at RPM:			Continuous Duty at RPM:			Max RPM	Weight Kg
		2600	2800	3300	2100	2500	2800	1800	2100	2400		
		HP	HP	HP	HP	HP	HP	HP	HP	HP		
TM345	1,54	126	135	147	63	75	84	47	55	62	4500	25
	2,00	102	110	130	63	75	84	47	55	62	4500	
	2,47	77	83	97	47	56	63	35	41	47	4500	
TM345A (8°)	1,54	126	135	147	63	75	84	47	55	62	4500	25
	2,00	102	110	130	63	75	84	47	55	62	4500	
	2,47	77	83	97	47	56	63	35	41	47	4500	
TM93	1,51	186	200	236	125	148	166	98	115	131	4500	51
	2,09	161	173	204	108	128	144	86	100	114	4500	
	2,40	142	153	180	95	114	127	77	90	103	4500	
	2,77	124	134	157	83	99	111	67	78	89	4500	
TM93A (8°)	1,51	171	185	218	106	126	141	63	73	84	4500	51
	2,09	142	153	180	88	105	118	52	61	69	4500	
	2,40	124	134	157	77	91	102	46	53	61	4500	
TM485A (8°)	1,51	174	188	221	109	129	145	79	92	105	4500	36
	2,09	174	188	221	109	129	145	79	92	105	4500	
	2,40	153	164	194	92	110	123	70	81	93	4500	
TM880A (10°)	1,53	321	346	395	197	235	263	141	164	187	4000	54
	2,08	321	346	395	197	235	263	141	164	187	4000	
	2,60	219	236	278	135	160	179	82	95	109	4000	
TM170	1,50	273	295	344	179	213	239	139	162	185	4000	75
	2,04	273	295	344	179	213	239	139	162	185	4000	
	2,50	219	236	278	143	171	191	111	130	148	4000	
	2,94	186	200	236	124	148	165	96	112	128	4000	
TM170A (10°)	1,53	273	295	344	168	200	224	100	117	134	4000	75
	2,08	273	295	344	168	200	224	100	117	134	4000	
	2,60	219	236	278	133	158	177	80	94	107	4000	
TM1200A (7°)	1,44	509	548	-	361	430	482	228	267	305	3200	120
	2,00	509	548	-	361	430	482	228	267	305	3200	
	2,30	435	469	-	308	367	411	193	225	257	3200	
TM265	1,17	386	416	-	277	330	370	210	245	279	3000	165
	1,50	386	416	-	277	330	370	210	245	279	3000	
	2,09	386	416	-	277	330	370	210	245	279	3000	
	2,82	386	416	-	277	330	370	210	245	279	3000	
TM265A (7°)	1,44	386	416	-	277	330	369	142	165	189	3000	165
	2,09	357	385	-	256	305	342	131	153	175	3000	
	2,30	325	350	-	233	277	310	119	139	159	3000	
TM200B	3,60	-	-	-	-	-	-	154	180	206	3000	235
	4,48	-	-	-	-	-	-	154	180	206	3000	
TM360	3,00	-	-	-	-	-	-	298	348	397	2600	415
	3,50	-	-	-	-	-	-	298	348	397	2600	
	4,00	-	-	-	-	-	-	298	348	397	2600	
	5,00	-	-	-	-	-	-	298	348	397	2600	

The SEA PROP drive system has been designed to handle more torque than existing products

- Ratios: 2,15:1 and 2.38:1
- Capable of input speeds up to 3.800 rpm
- Marine transmission with mechanically actuated cone clutches
- Made of sea water resistant aluminum
- Robust design for continuous duty
- Output shaft thrust bearing designed to take max. propeller thrust
- Compatible with most if not all propellers (LH&RH) available
- Suitable for left- & right handed (folding) propellers. Ideal for catamarans!
- Full safety because of by double membrane
- Can be drained off the lube from the top with the boat in the water
- The head of the drive can be turned 180° providing engine installation back to front (8 x 45° steps!)
- Dry weight 39kg
- Oil quantity 2,5l – Oil type: ATF
- Propeller shaft thread: 16mm
- Input shaft: 10 splines (B10x23x29)

Mounts like TMC or ZF/Hurth HBW50-150 gearboxes

**Item Code TMSDTMC215/1**

Sea Prop Saildrive, R=2,15:1

**Item Code TMSDTMC238/1**

Sea Prop Saildrive, R=2,38:1

Optionals:

- Damper plate (please specify dims.)
- SAE-7, SAE-4 or SAE-5 flanges
- Ball valve for cooling water
- Propeller (aluminum fixed 2/3-blade LH & bronze 2-blade folding).

- Item Code 2076001** Water alarm sensor
- Item Code 1054011** Propeller cone nut complete
- Item Code 2030084** Polyester base
- Item Code 05.2050039** Zink anode
- Item Code 05.2050043** Magnesium anode
- Item Code 05.2050044** "All water" anode
- Item Code 05.2012175** Membrane, lower
- Item Code 05.2012176** Membrane, upper, prepared for water sensor
- Item Code 05.1059053** Gasket set/Seal kit, incl. Membranes
- Item Code 501001** Rubber hull cover



501001

**Saildrive „Sea Prop 60“**

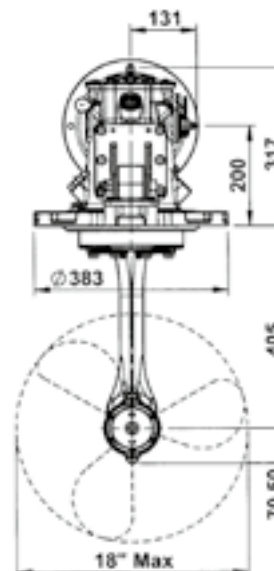
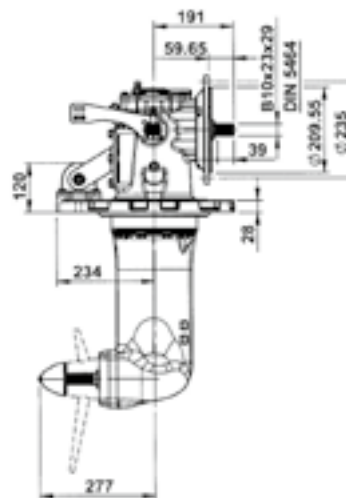

Input Ratings kW (HP)				
Reduction	Pleasure		Intermediate	
2,15:1	2800 rpm	3000 rpm	2800 rpm	3000 rpm
	46kW (62HP)	49kW (66HP)	38kW (52HP)	40kW (55HP)
2,38:1	3600 rpm	3800 rpm	3600 rpm	3800 rpm
	44kW (60HP)	46kW (62HP)	36kW (48HP)	38kW (51HP)

## POLAR STAR Damper plates with plastic core Type PSMC 20 – Single Stage



Diam. mm	Cont. Nm	Max. Nm	Splines	Hole pitch Ø	Mounting mm	Flywheel SAE J620	Height F mm	Item Code
121.5	200	350	10T	111	8 x Ø6.5	-	31	AL400001
121.5	250	400	26T	111	8 x Ø6.5	-	47.5 ± 6.5	AL400005
151.3	200	350	10T	140	8 x Ø6.5	-	31	AL400002
151.3	250	400	10T	140	8 x Ø6.5	-	47.5 ± 6.5	AL400006
151.3	200	350	26T	140	8 x Ø6.5	-	47.5 ± 6.5	AL400009
159.0	200	350	10T	142	5 x Ø9	-	31	AL400021
159.0	200	350	26T	142	5 x Ø9	-	47.5 ± 6.5	AL400023
185.0	200	350	10T	175	6 x Ø6.5	-	31	AL400024
185.0	200	350	26T	175	6 x Ø6.5	-	47.5 ± 6.5	AL400026
190.0	200	350	10T	170	6 x Ø9.3	-	31	AL400018
190.0	300	550	26T	170	6 x Ø9.3	-	47.5 ± 6.5	AL400020
215.9	200	350	10T	200	6 x Ø9	6-1/2"	31	AL400003
215.9	250	400	10T	200	6 x Ø9	6-1/2"	47.5 ± 6.5	AL400007
215.9	300	550	26T	200	6 x Ø9	6-1/2"	47.5 ± 6.5	AL400008
241.3	200	350	10T	222.2	8 x Ø9	7-1/2"	31	AL400004
241.3	250	400	10T	222.2	8 x Ø9	7-1/2"	47.5 ± 6.5	AL400011
241.3	300	550	26T	222.2	8 x Ø9	7-1/2"	47.5 ± 6.5	AL400010

Diam. mm	Cont. Nm	Max. Nm	Splines	Hole pitch Ø	Mounting mm	Flywheel SAE J620	Height F mm	Item Code
263.52	300	550	10T	244.5	8 x Ø11	8"	47.5 ± 6.5	AL400015
263.52	300	550	26T	244.5	8 x Ø11	8"	47.5 ± 6.5	AL400012
314.32	300	550	10T	295.3	8 x Ø11	10"	47.5 ± 6.5	AL400016
314.32	300	550	26T	295.3	8 x Ø11	10"	47.5 ± 6.5	AL400013
352.4	300	550	10T	333.38	8 x Ø11	11-1/2"	47.5 ± 6.5	AL400017
352.4	300	550	26T	333.38	8 x Ø11	11-1/2"	47.5 ± 6.5	AL400014

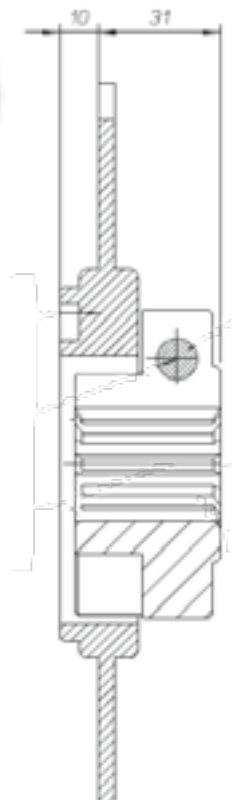

- Code 300302 Hub damper plate 10 teeth, low
- Code 300303 Hub damper plate 26 teeth, low
- Code 300305 Hub damper plate 26 teeth, high



## POLAR STAR Damper plates with flexible element Type PSM 55/60 – Dual Stage

Diam. mm (A)	Cont. Nm	Max. Nm	Splines	Hole pitch mm (B)	Mounting mm (C)	Flywheel SAE J620	mm (D)	mm (E)	mm (F)	mm (G)	Item Code
215.9	500	800	26T	200.02	6 x Ø8.5	6-1/2"	37	182	4	-	AL420017
241.3	500	800	26T	222.25	8 x Ø8.5	7-1/2"	37	182	4	-	AL420018
263.52	600	1000	26T	244.5	6 x Ø11	8"	37	182	4	-	AL420026
280.00	600	1000	26T	255	6x Ø8.5	Hyundai D170	42	182	4	-	AL420025
314.32	600	1000	26T	295.3	8 x Ø11	10"	42	182	4	-	AL420027
352.4	600	1000	26T	333.4	8 x Ø11	11-1/2"	42	182	4	-	AL420028

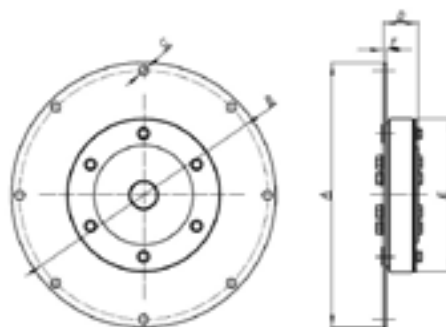

## POLAR STAR Damper plates with flexible element Type PSM 120 – Dual Stage

Diam. mm (A)	Cont. Nm	Max. Nm	Splines	Hole pitch mm (B)	Mounting mm (C)	Flywheel SAE J620	mm (D)	mm (E)	mm (F)	mm (G)	Item Code
263.52	1200	1800	26T	244.5	6 x Ø11	8"	44	230	4	5	AL420017
314.32	1200	1800	26T	295.3	8 x Ø11	10"	44	230	4	5	AL420018
352.4	1200	1800	26T	333.4	8 x Ø11	11-1/2"	44	230	4	5	AL420026
352.4	1200	1800	27T	333.4	8 x Ø11	11-1/2"	44	230	4	5	AL420025
352.4	1200	1800	29T	333.4	8 x Ø11	11-1/2"	44	230	4	5	AL420027
352.4	1200	1800	Cil. Ø30	333.4	8 x Ø11	11-1/2"	44	230	4	5	AL420028

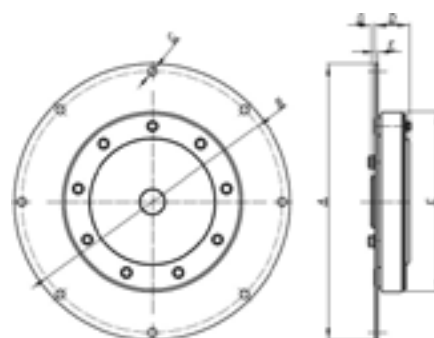
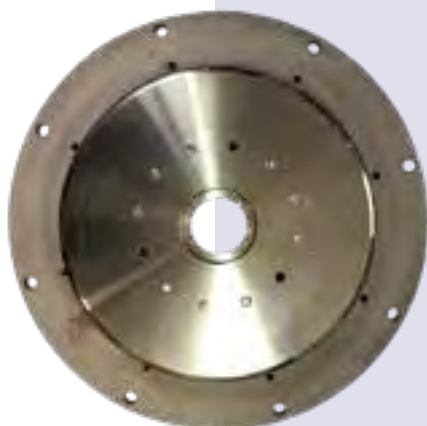

### Half-Couplings sizes

A	B	C	E	F	G	H	I
68	65	3	10	63,5	102	10,5	82,5
68	85	3	11	63,5	127	11,5	108
68	65	3	10,5	63,5	102	10,5	82,5
93	90	3	11,5	63,5	127	11,5	108
120	117	3	11,8	63,5	102	10,5	82,5
70	67	3	10,5	50	100	10,5	78
93	90	3	11,8	65	127	12,5	100
93	90	3	11,8	65	120	10,5	100
70	70	-3,5	10,5	60	100	10,5	80
84	84	-3,5	10,5	60	100	10,5	80
166	166	-5	16,2	76,2	146	17	120,65

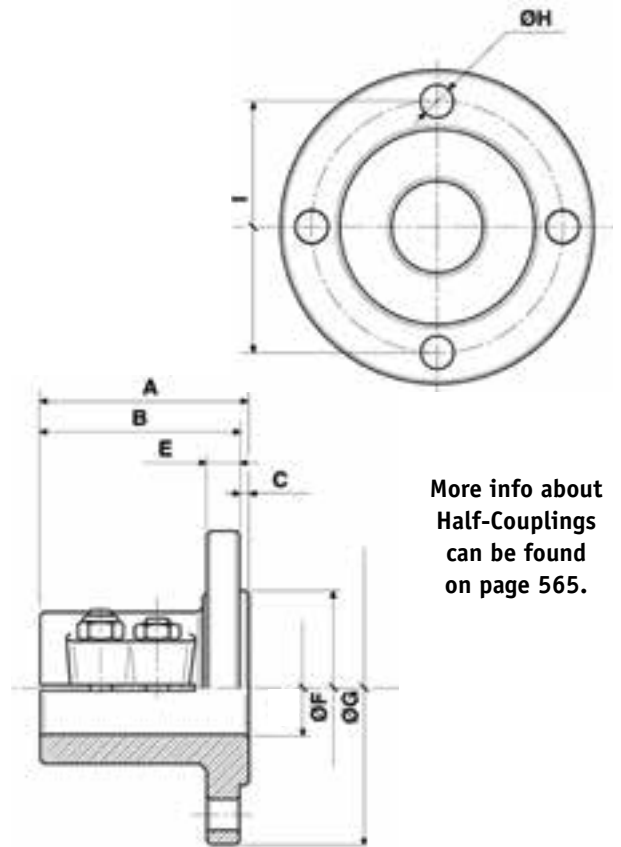

More info about Half-Couplings can be found on page 565.

### SAE - Adapter Flanges

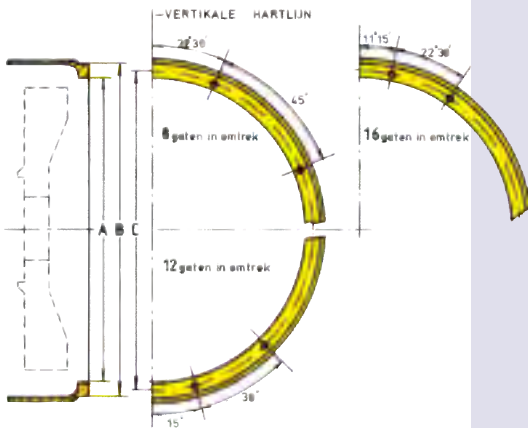

SAE-Code	A		B (mm)	C		Nr of holes	Ø
	Max. (mm)	Min. (mm)		Max. (mm)	Min. (mm)		
7	209,52	209,47	263,65	234,98	234,94	6	3/8"
6	266,78	266,70	307,98	285,88	285,62	8	3/8"
5	314,40	314,33	355,60	333,50	333,25	8	3/8"
4	362,04	361,95	403,25	381,13	380,87	12	3/8"
3	409,68	409,58	450,85	428,75	428,50	12	3/8"
2	447,78	447,68	488,95	466,85	466,60	12	3/8"
1	511,29	511,18	552,45	530,35	530,10	12	7/16"
0	647,83	647,70	711,20	679,58	679,32	16	1/2"
00	787,53	787,40	885,65	851,03	850,77	16	1/2"

Item Code 22.10110001

Separate house

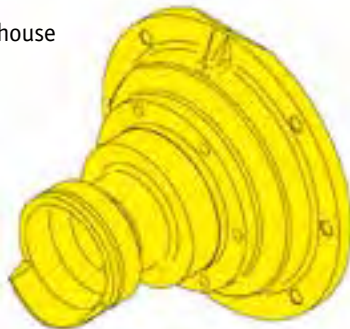

### SAE-7 Adapter for Volvo Stern Drive

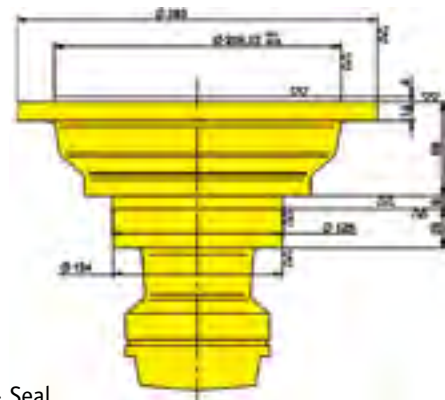

Item Code 22.1331/S Set: Housing - Shaft - Bearing - Seal



 <b>Item Code 1066159</b> Ø159mm, 10-T, 170Nm	 <b>Item Code 2062143</b> Ø151,3mm, 26-T, 250Nm	 <b>Item Code 1067274</b> 336,5mm, 26-T, 550Nm	 <b>Item Code 42AG117</b> Ø276mm, 26-T, 270Nm, 33°	 <b>Item Code 1066235</b> Ø235mm, 10-T, 170Nm
 <b>Item Code 1067270</b> Ø270mm, 26-T, 250Nm	 <b>Item Code 4648004</b> 6-1/2" DS 22, 26-T, TM345(A)	 <b>Item Code 4648005</b> 7-1/2" DS 22, 26-T, TM345(A)	 <b>Item Code 4648019</b> 11-1/2" DS 25, 26-T, TM485A	 <b>Item Code 4648020</b> 11-1/2" DS 30, 26-T, TM170-880
 <b>Item Code 4648055</b> 11-1/2" DS 40, TM265	 <b>Item Code 1070099</b> 10" Rubber Block Drive Ø313mm, TM93/TM485A	 <b>Item Code 1070098</b> 11-1/2" Rubber Block Drive Ø352mm, TM170-880	 <b>Item Code 4648072</b> 11-1/2" Rubber Block Drive Ø352mm, TM265	 <b>Item Code 4648042</b> 14" Rubber Block Drive Ø463mm, TM265
 <b>Item Code 2011272</b> SAE-7 TMC40-60-260	 <b>Item Code 1070097</b> SAE-7 H=13,5mm, TM93->880	 <b>Item Code 1070131</b> SAE-7 H=30mm, TM93->880	 <b>Item Code 1070156</b> SAE-4 H=12,5mm TM93-880	 <b>Item Code 1070157</b> SAE-3 H=33mm TM93-170-88A
 <b>Item Code 1070154</b> SAE-3 H=12,5mm, TM170->880	 <b>Item Code 1070150</b> SAE-3 TM265	 <b>Item Code 1070151</b> SAE-2 TM265	 <b>Item Code 1070152</b> SAE-1 TM265	 <b>Item Code 1065245</b> SAE-7 PRM 160-260
 <b>Item Code 2011333</b> SAE-7 x SAE-5, H=12,5mm	 <b>Item Code 1023035</b> Oil cooler TMC60	 <b>Item Code 1023045</b> Oil cooler TMC260	 <b>Item Code 1023041</b> Oil cooler TM345	 <b>Item Code 1023023</b> Oil cooler TM93->880
 <b>Item Code 2011355</b> SAE-7 x SAE-3, H=12,5mm	<p><b>This is only a summary of the numerous connection options for Technodrive- and other marine gearboxes.</b></p> <p><b>Please ask allpa for additional info.</b></p>		 <b>Item Code 1065003</b> Shift bracket TMC40 & TMC40M, TM345-93-485-265.	 <b>Item Code 1023027</b> Oil cooler TM265
			 <b>Item Code 1065005</b> => TMC40P, TM170-880	 <b>Item Code 1065002</b> Shift bracket TMC60 & 260



allpa supplies an adapter for exchange of the old Volvo gearbox type MS2 (Series 2000) for a Technodrive gearbox model TMC40, TMC60 or TMC260. Item Code 1070007



SAE-4 flange



Dual Stage damper



Rubber Block Drive

## Technodrive Accessories

TMC40	Item Code
Sae-7 flange (BW)	2011272
Sae-5 flange	2011166
Damper plate Ø151,3mm (several executions available)	2062144
Cable bracket TMC40/TMC40M	1065003
Cable bracket TMC40P	1065005

TMC60	Item Code
Sae-7 flange (BW)	2011272
Sae-5 flange	2011166
Damper plate Ø151,3mm (several executions available)	2062144
Extra pulley	1051022
Oil cooler (Ø 20mm)	1023035
Cable bracket	1065002

TMC 260	Item Code
Sae-7 flange (BW)	2011272
Sae-5 flange	2011166
Sae-6 x Sae-7 Adapter flange (H=15mm/W.H.=11mm)	1070005
Sae-7 x Sae-5 Adapter flange (H=11mm)	2011333
6-1/2" Centaflex Dual Stage damper plate	4648004
Oil cooler	1023045
Steel Spring Damper plate 26T Ø 151,3mm	2062143
Cable bracket	1065002

TM345	Item Code
Sae-7 x Sae-5 Adapter flange (H=12.5mm)	1070142
Sae-7 x Sae-4 Adapter flange (H=12.5mm)	2011332
Sae-7 x Sae-5 Adapter flange (H=12.5mm)	1070142+
+ adapter ring (H=63.0mm) for Yanmar 3.4JH3	4571002
Sae-7 x Sae-3 Adapter flange	2011355
6-1/2" Centaflex Dual Stage damper plate	4648004
7-1/2" Centaflex Dual Stage damper plate	4648005
Centaflex Dual Stage damper plate for Yanmar 3.4JH3	4648053
Centaflex Dual Stage damper plate for AIFO 8141	4648007
Counter flange for propeller shaft, pilot bored	2074040
Heat exchanger kit (oil cooler) c/w oil hoses & fittings	1023041
Heat exchanger kit (oil cooler) for Yanmar 4JH	1023042
Steel Spring Damper plate 26T Ø 151,3mm	2062143
Cable bracket	1065003
Sae-7 x Sae-5 Adapter flange (H=12.5mm)	2011333
Trolling Valve Kit	1033004/S

TM93	Item Code
Sae-3 Flange (H=12,5mm)	1070155
Sae-3 Flange (H=33mm)	1070157
Sae-4 Flange (H=12,5mm)	1070156
Sae-4 Flange (H=33mm)	1070158
Sae-7 Flange (BW) (H=13,5mm)	1070097
Sae-7 Flange (BW) (H=30mm)	1070131
Centa Dual Stage damper plate DS25, 10"	4648018
Centa Dual Stage damper plate DS25, 11-1/2"	4648019
Centa Dual Stage damper plate DS for AIFO 8141	4648007
10" Rubber Block Drive (D = 313mm, pitch 293mm)	1070099
11-1/2" Rubber Block Drive (D = 352mm, pitch 332mm)	1070098
Counter flange for propeller shaft, pilot bored	1068001
Heat exchanger kit (oil cooler) c/w oil hoses & fittings	1023023
Cable bracket	1065003
Sae-7 x 5 flange (H=12.5mm)	2011333
Trolling Valve Kit	1033001/S

TM485A	Item Code
Sae-3 Flange (H=12,5mm)	1070155
Sae-3 Flange (H=33mm)	1070157
Sae-4 Flange (H=12,5mm)	1070187
Sae-4 Flange (H=33mm)	1070158
Sae-4 Flange for Yanmar LH (H=50mm)	1070144
Sae-7 Flange (BW) (H=13,5mm)	1070097
Sae-7 Flange (BW) (H=30mm)	1070131
Centaflex Dual Stage damper plate DS25, 10"	4648018
Centaflex Dual Stage damper plate DS25, 11-1/2"	4648019
Centaflex Dual Stage damper plate DS for Yanmar LH	4648054
Counter flange for propeller shaft, pilot bored	1068001
Heat exchanger kit (oil cooler) c/w oil hoses & fittings	1023023
Heat exchanger kit (oil cooler) for Yanmar JH	1023043
Cable bracket	1065003
Sae-7 x 5 flange (H=12.5mm)	2011333
Trolling Valve Kit	1033010/S

## Technodrive Accessories

TM880 / TM170	Item Code
Sae-2 Flange	2011273
Sae-3 Flange (H=12,5mm)	1070154
Sae-3 Flange (H=33mm)	1070157
Sae-4 Flange (H=12,5mm)	1070156
Sae-4 Flange (H=33mm)	1070158
Sae-7 Flange (BW) (H=13,5mm)	1070097
Sae-7 Flange (BW) (H=30mm)	1070131
Sae-3 Flange (CAT)	1070161
Sae-7 x 5 Flange (H=12.5mm)	2011333
Dual Stage damper plate Centa DS30, 11-1/2 "	4648020
Dual Stage damper plate Centa DS30 for Yanmar 6LYUTE	4648021
Counter Flange for propeller shaft, pilot bored	1068001
Heat exchanger kit (oil cooler) c/w oil hoses & fittings	1023023
Cable bracket	1065005
Gearbox supports (pair)	1052001
Trolling Valve Kit TM880(A)	1033007/S
Trolling Valve Kit TM170(A)	1033002/S



SAE-7 flange

TM265	Item Code
PTO Power Take Off for TM265, SAE-B, Z-15, 2-holes, max 195 Nm	1051032
PTO Power Take Off for TM265, SAE-B, Z-15, 4-holes, max 195 Nm	1051015
Sae-3 Flange	1070150
Sae-2 Flange	1070151
Sae-1 Flange	1070152
Dual Stage damper plate Centa DS40, 11-1/2 "	4648055
Dual Stage damper plate Centa DS40, 14"	4648056
Sae-3 Flange with 11-1/2 " Rubber Block Drive (D = 352mm, pitch 332mm)	1070105
Sae-3 Flange with 11-1/2 " Vulkan Coupling (V3414)	1070137
Sae-3 Flange with 11-1/2 " Centa DS40 Coupling	1070168
Sae-2 Flange with 11-1/2 " Rubber Block Drive (D = 352mm, pitch 332mm)	1070114
Sae-2 Flange with 11-1/2 " Centa DS40 Coupling	1070169
Sae-1 Flange with 11-1/2 " Centa DS40 Coupling	1070170
Sae-1 Flange with 14" Rubber Block Drive (D = 463mm, pitch 436mm)	1070113
Sae-1 Flange with 14" Vulkan Coupling (V3414)	1070138
Counter Flange for propeller shaft, pilot bored	1068010
Heat exchanger kit (oil cooler) c/w oil hoses & fittings	1023027
Cable bracket	1065003
Gearbox supports (pair)	1052002
Trolling Valve Kit	1033003/S
Only Rubber Block Drive 11-1/2 "	4648072
Only Rubber Block Drive 14 "	4648042

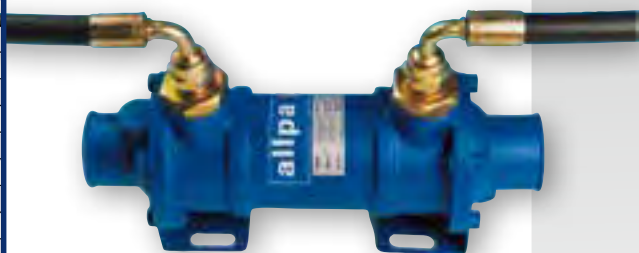

oil cooler

TM200B	Item Code
Sae-3 Flange with 11-1/2 " Rubber Block Drive (D = 352mm, pitch 332mm)	1070003
Sae-2 Flange with 11-1/2 " Rubber Block Drive (D = 352mm, pitch 332mm)	1070002
Sae-1 Flange with 11-1/2 " Rubber Block Drive (D = 352mm, pitch 332mm)	1070001
Heat exchanger kit (oil cooler) c/w oil hoses & fittings	1023003

TM360	Item Code
Sae-1 Flange	2011247
Sae-2 Flange	2011267
14" Centaflex Dual Stage DS45 damper plate	4648057
Sae-1 Flange with 14" Rubber Block Drive (D = 463mm)	1070104
Sae-1 Flange with 14" Vulkan Coupling (V3414)	1070139
Sae-3 Flange with 11-1/2 " Rubber Block Drive	1070130
Contraflens	1068020
Oliekoeler-kit	1023026
Gearbox supports (pair)	1052003

TM1200	Item Code
Sae-3 Flange	1070177
Sae-2 Flange	1070179
Sae-1 Flange	1070178
11-1/2" Centaflex Coupling CF-R-136	4648064
11-1/2 " Vulkardan Coupling 2K 341	4648031
14" Centa Coupling CF-R-136	4648065
14" Vulkardan Coupling 2K 341	4648032
3-3/4" Counter flange for propeller shaft, pilot bored	1068030
Heat exchanger kit (oil cooler) c/w oil hoses & fittings	1023046
Gearbox supports (pair)	1052004
Trolling Valve Kit	1033009/S
Electric control valve	4643003



Dual Stage Damper Plate



**Technodrive  
Trolling Valve  
Kits**



**Item Code 1033001/S** Trolling Valve Kit for TM93 & TM93A

**Item Code 1033002/S** Trolling Valve Kit for TM170 & TM170A

**Item Code 1033003/S** Trolling Valve Kit for TM265 & TM265A

**Item Code 1033004/S** Trolling Valve Kit for TM345 & TM345A

**Item Code 1033007/S** Trolling Valve Kit for TM880A

**Item Code 1033009/S** Trolling Valve Kit for TM1200A

**Item Code 1033010/S** Trolling Valve Kit for TM485A



**Technodrive  
Electric Shift  
Kits**

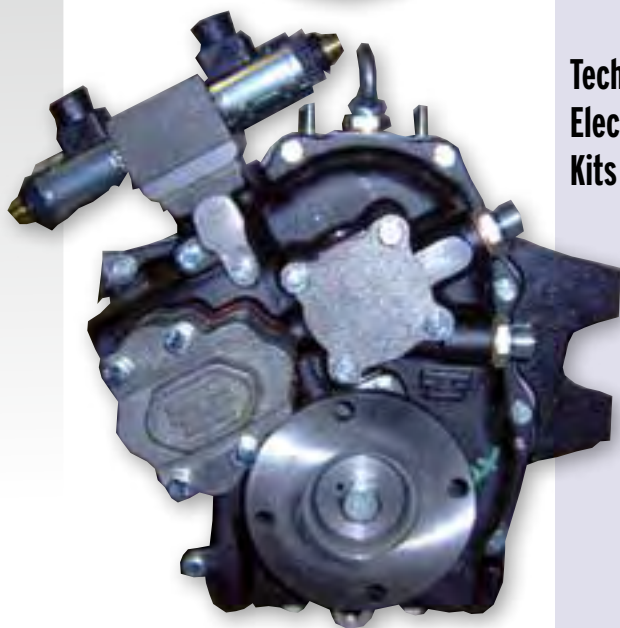

**Item Code 1026008** 12V Electric Shift Kit for:  
TM93 – TM93A – TM170 – TM170A  
TM880A – TM265 – TM265A

**Item Code 1026009** 24V Electric Shift Kit for:  
TM93 – TM93A – TM170 – TM170A  
TM880A – TM265 – TM265A

**Item Code 1026012** 12V Electric Shift Kit for:  
TM485A



- **TM345 & TM345A:** No electric shift possible
- **TM485A :** Only 12 V
- **TM1200A:** Comes complete with Electric Shift as a standard
- **TM200B and TM360:** No Electric Shift available

# allpa FLANGE ADAPTERS

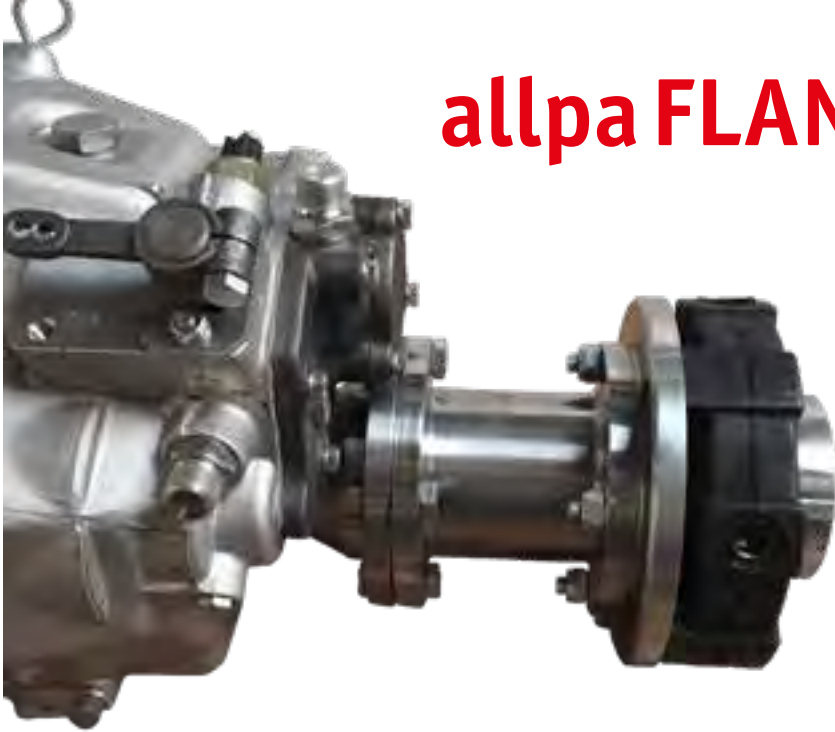

040000B



040001/12B



040002/12B



040000



040001



040002



040004

(\*): not shown

Item Code	Type	Length mm	Center 1 mm	Pitch 1 mm	Mounting 1 mm	Center 2 mm	Pitch 2 mm	Mounting 2 mm	Application (example)
040000	5"	L = 100	63.5 <b>F</b>	107.95	4 x 10.5	63.5 <b>M</b>	107.95	4 x 11.5	TM345 to TM170
040000B	5"	L = 80	63.5 <b>F</b>	107.95	8 x 10.5	63.5 <b>M</b>	107.95	8 x 10.5	Centa AM80-1.0 * MG5020
040001	5" x 5-3/4"	L = 83	63.5 <b>F</b>	107.95	8 x 10.5	76.2 <b>F</b>	120.65	6 x 14.0	TM265
040001/12B	5" x 5-3/4"	L = 80	63.5 <b>F</b>	107.95	8 x 10.5	76.2 <b>M</b>	120.65	6 x 12.5	Centa AM80-1,2 * ZF45
040002	4"	L = 80	63.5 <b>F</b>	82.5	4 x 10.5	63.5 <b>M</b>	82.5	4 x 10.5	TMC40-60-260
040002/12B	5" x 5-3/4"	L = 110	63.5 <b>F</b>	107.95	8 x 10.5	63.5 <b>F</b>	120.65	6 x 14.0	Centa AM140-1.2 * ZF220
040003/31B(*)	5-3/4"	L = 120	76.2 <b>F</b>	120.65	6 x 17.0	63.5 <b>F</b>	107.95	8 x 11.5	Centa AM200-1.2 * MG5050
040004	4" x 5"	L = 100	63.5 <b>F</b>	82.5	4 x 10.5	63.5 <b>M</b>	107.95	4 x 10.5	4" to 5" adapter
088090(*)	4"	L = 21	63.5 <b>F</b>	82.5	4 x 10.0	60.0 <b>F</b>	80.0	4 x 10.5	4" to Volvo 60x80
088095(*)	4"	L = 45	63.5 <b>F</b>	82.5	4 x 10.5	50.0 <b>M</b>	78.0	4 x 10.5	4" to Yanmar Kanzaki 50x78
088096(*)	4"	L = 53	63.5 <b>F</b>	82.5	4 x 10.5	65.0 <b>M</b>	100.0	4 x 10.5	4" to Yanmar Kanzaki 65x100



## Centaflex M-127

### Centaflex Flexible Marine Couplings M-127

Highly flexible couplings for mounting between gear and propeller shaft providing a dramatic reduction of noise and vibration. Due to the large volume of rubber used a very smooth transmission of torque and propeller thrust is achieved. The noise level will drop up to 5dBA, meaning a reduction of to one-third. The couplings have a fail-save device which ensures that power can continue to be transmitted even if the rubber fails. All couplings are fastened to the plain cylindrical propeller shaft by means of a securely dimensioned clamping hub. The couplings are electrically insulating and therefore give protection from electrolysis damage.

#### Centaflex-M-127 Max. Propeller Shaft Torque (Nm)

Max.rpm	Commercial	Pleasure	Max. allow. angular misalignment
4500	175	250	2°

Type 1.4

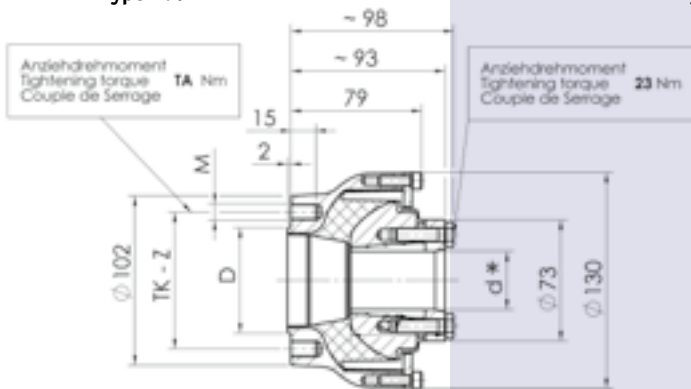

Type 2. ...

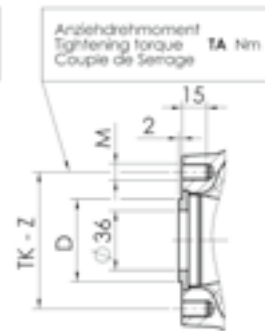

Type 3. ...

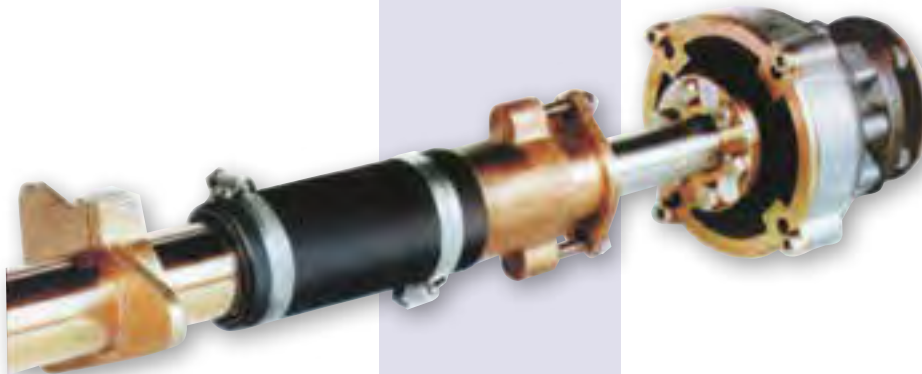
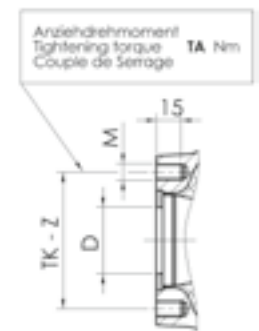

Item Code	Type	D	M	Tk	Z	Geartype (TKN > Tgear output)	TA (Nm)
088001	M-127-K1.4-*	63,5	M10	82,5	4x90°	4"-Flange, HBW, SOM, Velvet, ZF-BW7-A+C, BW12, Technodrive	45
088001/11	M-127-K1.1-*	66,65	M10	82,5	4x90°	Paragon ES40 (Gear flange to be bored to ø 10,5)	45
088001YANMAR	M-127-K2.2-*	50	M10	78	4x90°	Kanzaki KC30, KC100, Yanmar 1GM10, 2GM30 (3GM30, 3HM), KM2, KM3P, KM35P	45
088001/32	M-127-K3.2-*	60	M10	80	4x90°	Volvo MS2, MS10, MS15, MS25 (088001 + 088090)	45
088001BUKH	M-127-K3.3-*	47	M8	74,5	4x90°	ZF-BW7-Bukh	34
088001/34	M-127-K3.4-*	45	M10	75	4x90°	Farymann 15W, 18W, 32W	45
088001/37	M-127-K3.7-*	42	M6	62	6x60°	ZF-BW6 (with 10mm adaptor, length over all 104mm resp. 99mm)	10
088001/310	M-127-K3.10-*	38,1	M8	66,7	3x120°	Watermota	23

Standard bores M-127 for propeller shafts: d\*= 20, 25, 30, 35mm, 1", 1-1/2"

When ordering a flexible coupling you need to specify the right clamping hub for your propeller shaft diameter: **088001Kxx**. For example: Technodrive gearbox TMC40M, with a propeller shaft of Ø25: **088001** (M-127) plus **088001K25** (clamping hub).

When ordering, please state brand, type and ratio of you gearbox, hole pitch and centering ring of the output flange and the propeller shaft diameter!

## Centaflex Flexible Marine Couplings M-160

Highly flexible couplings for mounting between gear and propeller shaft providing a dramatic reduction of noise and vibration. Due to the large volume of rubber used a very smooth transmission of torque and propeller thrust is achieved. The noise level will drop up to 5dBA, meaning a reduction of to one-third. The couplings have a fail-safe device which ensures that power can continue to be transmitted even if the rubber fails. All couplings are fastened to the plain cylindrical propeller shaft by means of a securely dimensioned clamping hub. The couplings are electrically insulating and therefore give protection from electrolysis damage.

**Centaflex-M-160**  
Max. Propeller Shaft Torque (Nm)

Max.rpm	Commercial	Pleasure	Max. allow. angular misalignment
3500	350	500	2°

**Type 1.0**

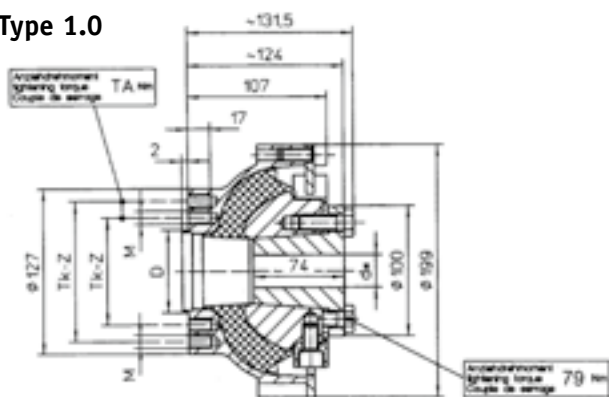

**Type 2. ...**

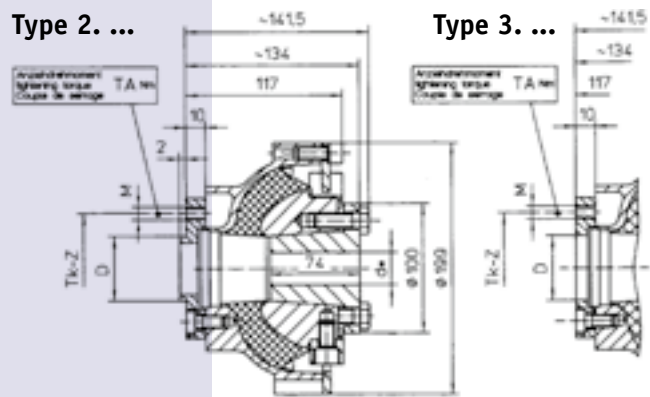

**Type 3. ...**

Item Code	Type	D	M	Tk	Z	Geartype (TKN > Tgear output)	TA (Nm)
088002	M-160-K1.0-*	63,5	M10	108 +82,5	4x90°	4"-5"-Flange, HBW, SOM, Velvet, ZF-BW7-A+C, BW12, Technodrive	45
088002/11	M-160-K1.1-*	66,65	M10	82,5	4x90°	Paragon ES40. P13L (Gear flange to be bored to ø 10,5)	45
088002YANMAR	M-160-K2.2-*	50	M10	78	4x90°	Kanzaki KC30, KC100, Yanmar 3GM30, 3HM	45
088002YANM23	M-160-K2.3-*	65	M10	100	4x90°	Kanzaki KC180, Yanmar 4JH-TE, 4JH3-TE	45
088002/32	M-160-K3.2-*	60	M10	80	4x90°	Volvo MS2 (088002 + 088090)	45
088002/33	M-160-K3.3-*	47	M8	74,5	4x90°	ZF-BW7-Bukh	23
By request!	M-160-K3.4-*	45	M10	75	4x90°	Farymann 15W, 18W, 32W (with adaptor So-3-03-028 also for Farym.95W)	45
088002/35	M-160-K3.5-*	45	M10	85	4x90°	Farymann 95W (with adaptor So-3-03-028 also for Farym.15W, 18W, 32W)	45
By request!	M-160-K3.6-*	73	M12	104,7	4x90°	Paragon P/PL/PM/PMB 15 (gear flange to be bored to Ø12,5)	79

Standard bores M-160 for propeller shafts: : d\*=25, 30, 35, 40mm, 1", 1-1/4", 1-1/2"

When ordering a flexible coupling you need to specify the right clamping hub for your propeller shaft diameter: **088002Kxx**. For example: Technodrive gearbox TMC60P, with a propeller shaft of Ø30: **088002** (M-160) plus **088002K30** (clamping hub).

**When ordering, please state brand, type and ratio of you gearbox, hole pitch and centering ring of the output flange and the propeller shaft diameter!**



**Centaflex**  
**M-160**



**Centaflex  
AM**

**Centaflex Flexible Marine Couplings AM**

Highly flexible couplings for mounting between gear and propeller shaft providing a dramatic reduction of noise and vibration. Due to the large volume of rubber used a very smooth transmission of torque and propeller thrust is achieved. The noise level will drop up to 5dBA, meaning a reduction of to one-third. The couplings have a fail-safe device which ensures that power can continue to be transmitted even if the rubber fails. All couplings are fastened to the plain cylindrical propeller shaft by means of a securely dimensioned clamping hub.

**Centaflex-AM  
Max. Propeller Shaft Torque (Nm)**

Item Code	Model	Max. rpm	Commercial	Pleasure	Max. allow. angular misalignment
088011	AM-030	4000	350	625	3°
088012	AM-050	4000	500	870	2°
088013	AM-080	4000	700	1125	2°
088014	AM-140	3600	1200	1875	2°
088015	AM-200	3000	2000	3000	2°

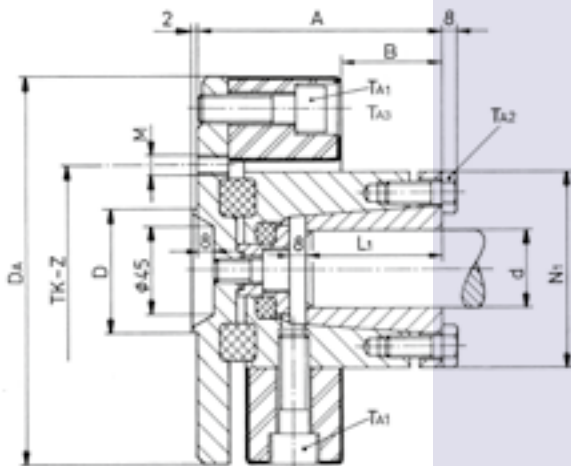

Item Code	Size	Flange	A	B	Da	TK	Z	D	Ø Prop.shaft		L1	N1	Ta1 + Ta3 (Nm)	Ta2 (Nm)	weight (kg)
									min	max					
088004	AM-12	1,4	99	51	120	82,5	4x90°	63,5	20	38,1	57	75	50	23	3,9
088005	AM-22	1,0	99	41	150	82,5+108	4x90°	63,5	20	38,1	57	80	85	23	5,5
088006	AM-28	1,0	102	40	170	82,5+108	4x90°	63,5	20	40	55	85	140	45	7,3
088011	AM-30	1,0	125	51	200	82,5+108	4x90°	63,5	25	50	70	100	220	79	10,6
088012	AM-50	1,2	125	51	200	108	8x45°	63,5	25	50	70	100	220	79	10,8
088013/12	AM-80	1,2	125	44	205	108	8x45°	63,5	25	50	70	100	220	79	11,3
088014	AM-140	1,2	138	48	260	108	8x45°	63,5	35	60	83	125	500	117	21,4
088015	AM-200	1,2	162	55	300	108	8x45°	63,5	40	80	90	145	500	79	32,5
	AM-250	-	172	60	340	-	-	-	45	80	100	160	500	117	43,8
	AM-400	-	199	67	370	-	-	-	50	100	120	170	*610/**1050	125	68,5

\*radial/\*\*axial

When ordering a flexible coupling you need to specify the right clamping hub for your propeller shaft diameter: **088011Kxx**. For example: Technodrive gearbox with a propeller shaft of Ø35: **088011** (AM-30) plus **088011K35** (clamping hub).

When ordering, please state brand, type and ratio of you gearbox, hole pitch and centering ring of the output flange and the propeller shaft diameter!



## Centaflex Flexible Marine Couplings AGM

### Double couplings with thrust bearing

Highly flexible couplings for mounting between gear and propeller shaft providing a dramatic reduction of noise and vibration. Due to the large volume of rubber used a very smooth transmission of torque and propeller thrust is achieved. The noise level will drop up to 5dBA, meaning a reduction of to one-third. The couplings have a fail-safe device which ensures that power can continue to be transmitted even if the rubber fails. All couplings are fastened to the plain cylindrical propeller shaft by means of a securely dimensioned clamping hub.

**Centaflex-AGM**  
Max. Propeller Shaft Torque (Nm)

Item Code	Model	Max. rpm	Com-mercial	Pleasure	Max. allow. angular misalignment
088021	AGM-016	3000	130	250	2x3°
088022	AGM-025	2500	200	375	2x3°
088023	AGM-030	2000	350	625	2x3°
088024	AGM-050	2000	500	870	2x3°
088025	AGM-080	2000	700	1125	2x3°
088026	AGM-140	1500	1200	1875	2x3°
088027	AGM-200	1500	2000	3000	2x3°

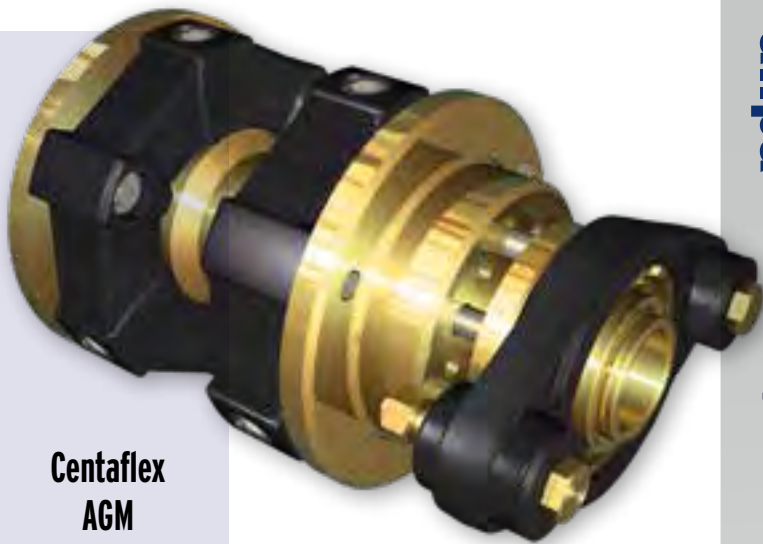

**Centaflex AGM**

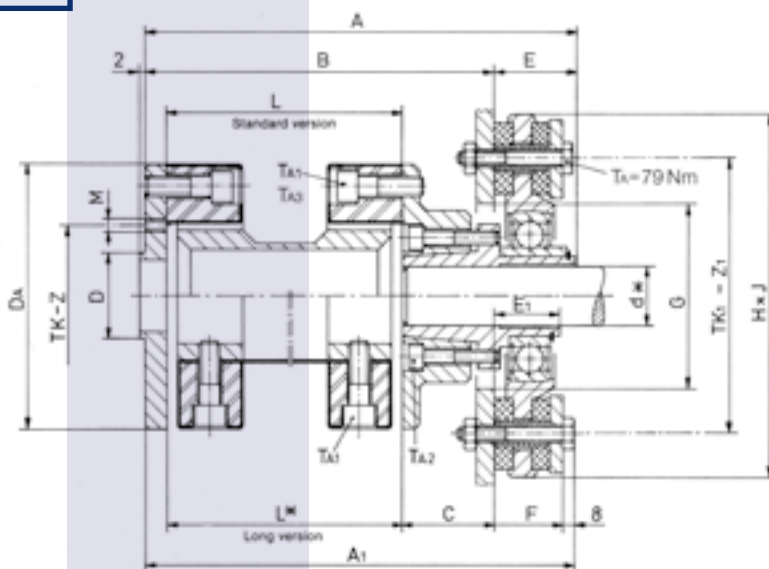

**Size guide will be sent on request.**

When ordering, please state brand, type and ratio of you gearbox, hole pitch and centering ring of the output flange and the propeller shaft diameter!

**For Flange Adapters: Please see page 555**



**a-flex****Features:**

- A propulsion system which reduces noise and vibrations up to 90%
- Simplifies engine/gearbox installations significantly
- Alignment procedure is very easily accomplished due to self-aligning propeller shaft clamp hub in thrust bearing
- Can handle angular misalignments of up to  $2 \times 8^\circ$
- CV drive shaft of variable length with two true plunging Constant Velocity joints working independently at any angle
- Solid thrust bearing transfers massive propulsion thrusts directly to the hull and not to the engine thus providing the possibility of softer flexible engine mounts
- Thrust bearing coupling is fastened to the plain cylindrical propeller shaft by means of a securely dimensioned clamping hub

A complete system consists of: CV-Drive Shaft, Thrust Bearing and Gearbox Adapter according to measure (see page 563) as well as bolts, nuts and rings, while the kit price is fixed.

When ordering, please state engine power and max. rpm, brand of gearbox, type and ratio, hole centre and centering ring of the output flange and the propeller shaft diameter.

**Note:** The given max. values for torque and propeller thrust are meant for pleasure craft with less than 100 hours at full load.

For commercial applications 60-80% of the given values should be considered as max. load.

**Max. installation angle is related to propeller shaft rpm:**

- $8^\circ$  angle per joint => max 1200 rpm
- $6^\circ$  angle per joint => max 1500 rpm
- $5^\circ$  angle per joint => max 2000 rpm

**suitable for engine powers up to  $\pm 50$ hp**

- Max. propeller thrust 4300N
- Max. shaft torque 485Nm
- Max. shaft rpm: 5000
- Length CV-shaft:  $155 \pm 25$ mm
- Propeller shaft diameters: 20, 25, 30mm & 1", 1-1/4"
- Propeller shaft depth in thrust bearing: 60mm

**Item Code 099500**

Set HD-108 with thrust bearing, CV-shaft and adapter flange

**suitable for engine powers up to  $\pm 80$ hp**

- Max. propeller thrust 10500N
- Max. shaft torque 690Nm
- Max. shaft rpm: 5000
- Length CV-shaft:  $155 \pm 25$ mm
- Propeller shaft diameters: 30, 35, & 40mm
- Propeller shaft depth in thrust bearing: 90mm

**Item Code 099505**

Set HD-113 with thrust bearing, CV-shaft and adapter flange

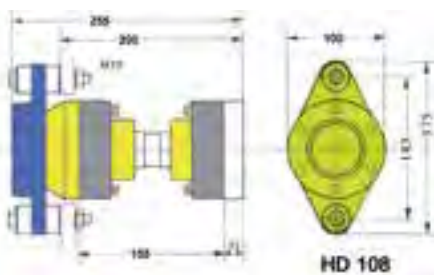
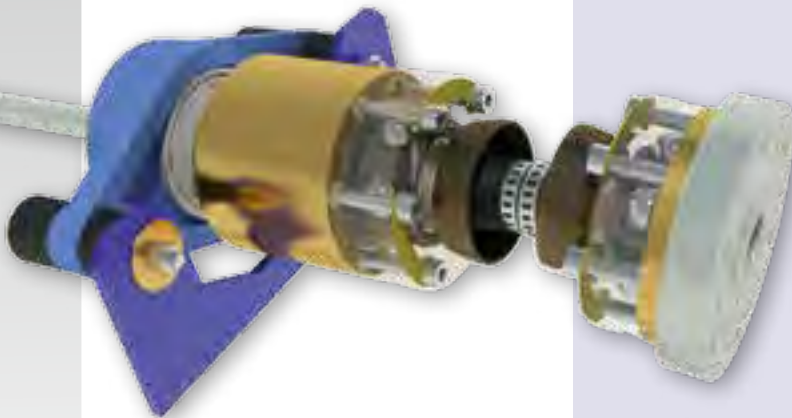
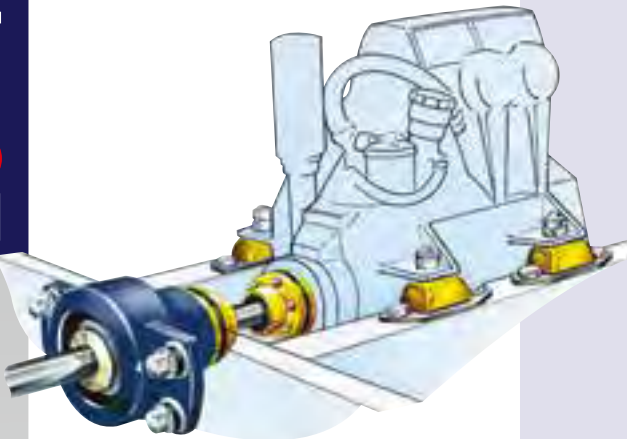
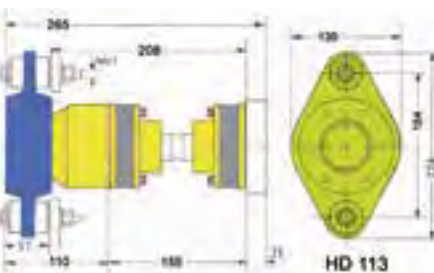
**CV-drive  
Shaft systems****Type HD-108****Type HD-113**

**suitable for engine powers up to ± 90hp**

- Max. propeller thrust 12500N
- Max. shaft torque 800Nm
- Max. shaft rpm: 5000
- Length CV-shaft: 170 ± 25mm
- Propeller shaft diameters: 35, 40, 45 & 50mm
- Full planing vessels: up to 135HP
- Propeller shaft depth in thrust bearing: 110mm



**Type HD-115L**

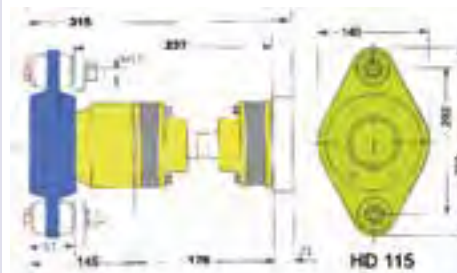

**Item Code 099510** Set HD-115L with thrust bearing, CV-shaft and adapter flange

**a-flex**

**suitable for engine powers up to ± 170hp**

- Max. propeller thrust 18000N
- Max. shaft torque 1100Nm
- Max. shaft rpm: 4000
- Length CV-shaft: 210 ± 40mm
- Propeller shaft diameters: 35, 40, 45, 50 & 55mm
- Full planing vessels: up to 220HP



**Type HD-125**

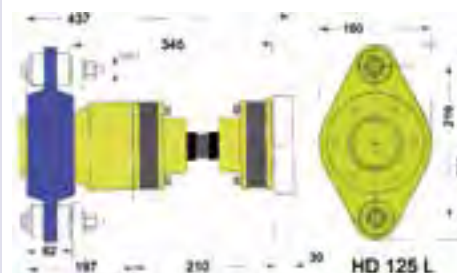

**Item Code 099515**

Set HD-125 with thrust bearing, CV-shaft and adapter flange

**a-flex**

**suitable for engine powers up to ± 250hp**

- Max. propeller thrust 25000N
- Max. shaft torque 1800Nm
- Max. shaft rpm: 4000
- Length CV-shaft: 240 ± 45mm
- Propeller shaft diameters: 40, 45, 50, 55 & 60mm
- Full planing vessels: up to 320HP



**Type HD-130**

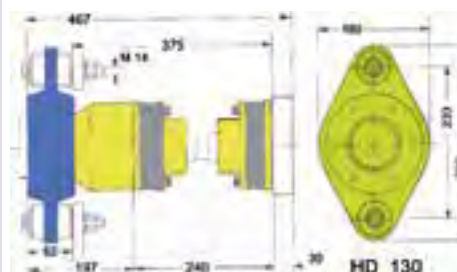

**Item Code 099520**

Set HD-130 with thrust bearing, CV-shaft and adapter flange

**a-flex**

**suitable for engine powers up to ± 350hp**

- Max. propeller thrust 38000N
- Max. shaft torque 3300Nm
- Max. shaft rpm: 4000
- Length CV-shaft: 275 ± 45mm
- Propeller shaft diameters: 40, 45, 50, 55, 60, 70, 80mm
- Full planing vessels: up to 475HP



**Type HD-142**

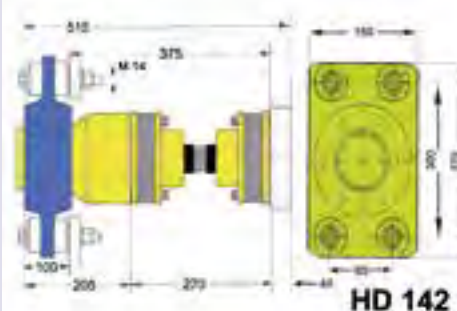

**Item Code 099525**

Set HD-142 with thrust bearing, CV-shaft and adapter flange

**a-flex**

# a-flex

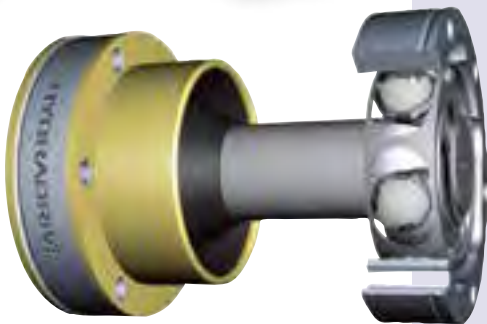
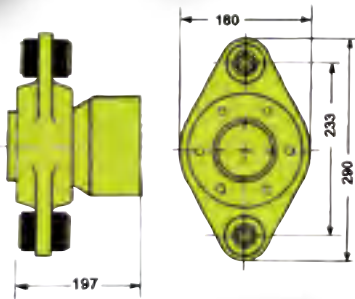

**Max. installation angle is related to propeller shaft rpm:**

- 8° angle per joint => max 1200 rpm
- 6° angle per joint => max 1500 rpm
- 5° angle per joint => max 2000 rpm
- 4° angle per joint => max 2500 rpm
- 3° angle per joint => max 4000 rpm
- 2° angle per joint => max 8000 rpm

**Separate, self-aligning Thrust Bearings:**

Shaft	Model 108	Model 113	Model 115L	Model 125	Model 130	Model 142
Ø mm	Item Code	Item Code	Item Code	Item Code	Item Code	Item Code
20	099600	---	---	---	---	---
22	099603	---	---	---	---	---
25	099601	---	---	---	---	---
30	099602	099610	---	---	---	---
35	---	099611	099620	099630	---	---
38,1	---	---	---	099629	---	---
40	---	099612	099621	099631	099640	---
45	---	---	099622	099632	099641	099648
50	---	---	099623	099633	099642	099647
55	---	---	---	099634	099643	---
60	---	---	---	---	099644	099650

**Anti Vibration System**

**CV-Joint Shafts:**

- Item Code 099700** Model 108 & 113, length 155± 25mm  
Outer ø103mm, pitch ø85mm
- Item Code 099710** Model 115, length 170 ± 25mm  
Outer ø109.5mm, pitch ø95mm
- Item Code 099715** Model 125, length 210 ± 40mm  
Outer ø130mm, pitch ø108mm
- Item Code 099720** Model 130, length 245 ± 45mm  
Outer ø150mm, pitch ø125mm
- Item Code 099723** Model 142, Length 270 ± 45mm  
Outer ø213mm, Pitch ø165mm

**Gearbox Adapters: (see p. 563)!**

A large number of different adapters is available for Techno-drive, Twin Disc, Hurth, PRM, Volvo, Yanmar, Velvet, Paragon etc. Most of them are standard stock.; some are made upon request.

- Item Code 099740** 4", centre ø63,5mm, pitch ø82,5mm, for model 108 & 113
- Item Code 099741** 5", centre ø63,5mm, pitch ø108mm, for model 115
- Item Code 099742** 5", centre ø63,5mm, pitch ø108mm, for model 125

**Calculating the Propeller Shaft Torque:**

(Max. HP : Max. Rpm) x 7120 x Gearbox Ratio = Max. propeller Shaft Torque (Nm)

**Calculating the Propeller Thrust:**

Max. HP x 80 = Propeller Shaft Thrust (N), where factor '80' concerns an average value

# a-flex Selection Table

## Gearbox Adapters

### Gearbox brand:

	Flange outer Ø (")	Flange outer Ø (mm)	A: No. of holes	B: Hole diameter (mm)	C: Hole pitch (mm)	D: Centering ring (mm)	CV-joint model						Remark
							HD108	HD113	HD115	HD125	HD130	HD142	
Blank adapter							099790	099790	099757	099761	099762	099763	
Bukh	3,54	90,00	4	8,20	74,50	47	099785	099785					Adapter flange
Buhk DV10/ZF/BW6													
Daewoo	7,25	184,15	6	14,20	152	100							
Daewoo	11,35	288,30	6	240	240	160							
Farymann	4	101,60	4	10	75	45	099756	099756					
Kanzaki KM35A/KM3P	4	101,60	4	10	78	50	099746	099746					
Kanzaki KM4A	5	127,00	4	10	100	65	099750	099750	099747				
Paragon	4	101,60	4	9,70	82,50	66,60	099767	099767	099755				
PRM, ZF/Hurth, Technodrive, Velvet, Ronim, SMI	4	101,60	4	10	82,50	63,50	099740	099740	099751				115-4" standard
PRM, ZF/Hurth, Technodrive, Velvet, Ronim, SMI	4	101,60	4	10	82,50	63,50	099745	099745	099741	099742	099748		115-tube type: L=120mm
PRM, ZF/Hurth, Technodrive, Velvet, Ronim, Volvo	5	127,00	4	11,20	108	63,50	099745	099745	099741	099742	099748		
PRM, MPM, Twin Disc, Velvet	5,75	146,05	6	12,70	120,60	76,20			099749	099752			
PRM, ZF/Hurth, MPM, Twin Disc, Velvet, Technodrive	5,75	146,05	6	16	120,60	76,20			099753	099766	099759		
PRM 750	6	152								099765			
Twin Disc	5	127,00	4	10	104,80	63,50							
Twin Disc 507 - 509	7,25	184,15	6	19	152,40	95,25							
Twin Disc	9	228,60	8	22,10	190,50	152,40							
Twin Disc	10,5	266,70	8	25,40	222	127							
Velvet, ZF/Hurth, PRM, Volvo 5"	5	127,00	4	10	108	63,50							
Volvo MS2 & MSB	4	101,60	4	10	80	60	099744	099744	099754				
Volvo (MS4A)	5	127,00	4	10	80	60							

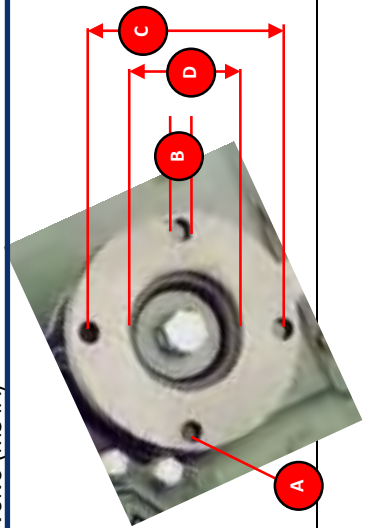

**Replacement clamps for thrust bearings:**

Shaft diameter 25mm	099791
Shaft diameter 30mm	099803
Shaft diameter 35mm	099798
Shaft diameter 38mm	099792
Shaft diameter 40mm	099794
Shaft diameter 45mm	099796
Shaft diameter 50mm	099797

Other adapters for HD142 on request

Adapter not found? Please contact us!

All adapters are supplied with bolts, nuts and other necessary parts



# allpa Custom-Made: Installations Our Specialization!

Please contact allpa through [inboard@allpa.eu](mailto:inboard@allpa.eu) for technical solutions.



**allpa**  
marine equipment

Item Code	Dimensions (mm)									Ref.	
	A	B	C	D	E	F	G	H	I		
518003	65		30	10			102	10	82,5	bronze	4"

### Bronze Half Couplings

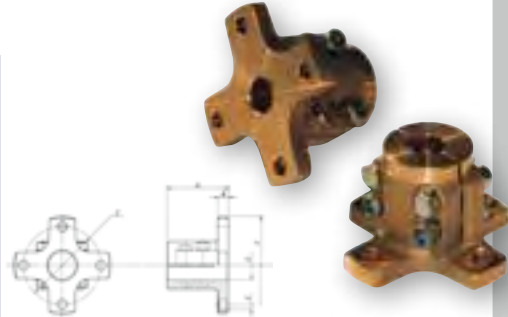

Item Code	A	B	C	D	E	F	G	H	I	Ref.	
518004	68	65	3	20	10	63,5	102	10,5	82,5	bronze	4"
518005	68	65	3	25	10	63,5	102	10,5	82,5	bronze	4"
518006	68	65	3	30	10	63,5	102	10,5	82,5	bronze	4"
518007	68	65	3	35	11	63,5	127	11,5	108	bronze	5"
518007/30	68	65	3	30	11	63,5	127	11,5	108	steel	5"
518008	68	65	3	40	11	63,5	127	11,5	108	bronze	5"
518045	101	98	3	45	12,5	63,5	132	12	108	steel	5"
518009	68	65	3	25	10,5	63,5	102	10,5	82,5	steel	4"
5180095	68	65	3	30	10,5	63,5	102	10,5	82,5	steel	4"
518011	93	90	3	35	11,5	63,5	127	11,5	108	steel	5"
5180115	120	117	3	35	11,8	63,5	102	10,5	82,5	steel	4"
518012	93	90	3	40	12	63,5	127	11,5	108	steel	5"
5180125	120	117	3	40	11,8	63,5	102	10,5	82,5	steel	4"
518020	166	166	-5	60	16,2	76,2	146	17	120,65	steel	6-gats
518009Y	70	67	3	25	10,5	50	100	10,5	78	steel	Yanmar
518010Y	70	67	3	30	10,5	50	100	10,5	78	steel	Yanmar
518011Y	93	90	3	35	11,8	65	127	12,5	100	steel	Yanmar
518012Y	93	90	3	40	11,8	65	127	12,5	100	steel	Yanmar
522240	93	90	3	40	11,8	65	120	10,5	100	steel	Yanmar
518009V	70	70	-3,5	25	10,5	60	100	10,5	80	steel	Volvo
518010V	83,5	83,5	-3,5	30	10,5	60	100	10,5	80	steel	Volvo

### Bronze & Steel Half-Couplings with centering ring



Item Code	A	B	C	D	E	F	G	H	I	Ref.	
522125	85	82	3	25	8,5	50	100	10,5	78	steel	Yanmar
522130	107	105	2	30	9	50	100	10,5	78	steel	Yanmar
522230	107	105	2	30	9	65	120	10,5	100	steel	Yanmar
522235	109	105	4	35	10	65	120	10,5	100	steel	Yanmar
522240	93	90	3	40	11,8	65	120	10,5	100	steel	Yanmar
522225	83	81	2	25	8,5	63,5	102	10,5	82,5	steel	4"
522330	106	104	2	30	9	63,5	102	10,5	82,5	steel	4"
522335	107	105	2	35	10	63,5	102	10,5	82,5	steel	4"
522435	109	105	4	35	10	63,5	127	11,5	108	steel	5"
522440	130	126	4	40	11	63,5	127	11,5	108	steel	5"
522329	83	83	-4	25	10	60	102	10,5	80	steel	Volvo
522331	106	106	-4	30	11	60	102	10,5	80	steel	Volvo

### Steel Half-Couplings with centering ring



Application Formula:  $M_t = (M_{tm} \times K_s \times K_c)$

- Pleasure: KS=1
- Commercial: KS=1,25
- ≤ 4 Cylinders: KC=1,2
- > 4 Cylinders: KC=1
- Torque(Nm) =  $M_{tm}$
- Max. Rpm = 2000

Item Code	Mt	A	B	C	D	E	F	G	H	a°	X	Y
001140	140(Nm)	82,5	108	10	11,2	44	12	140	56	2	1,5	3

### Flexible Rubber Couplings with metal inserts



Item Code	Mt	A	B	C	D	E	F	a°	X	Y
002200	200(Nm)	82,5	120	44	10,2	36	9	2	1,5	3

Max.Engine Power kW

Max Engine RPM (N)

X 9680 X Reduction Ratio = Max. Prop. Shaft Torque (Nm)

$\frac{hp}{N} \times 726 \times \text{Reduction Ratio} = \text{Max. Prop. shaft Torque (kgm)}$

Units: 1kgm = 9,807 Nm, 1 hp = 0,736kW, 1kg = 9,807N, 1 Kn = 1000N

Calculation  
Max. Propeller  
Shaft Torque



**allpa® Anti Vibration Mount V-Shaped**

**50° or 60° shore, Pin M16 x 1,5**

This Anti-vibration V-shaped mount is very suitable for engines without thrust bearing.

- Item Code 063150/S** 50° Shore, max. 50kg per mount
- Item Code 063160/S** 60° Shore, max. 60kg per mount

- A = 205mm
- B = 76mm
- C = 57mm
- D = 174mm
- E = 30mm Ø30mm
- M = M16 x 1,5



063097  
063098

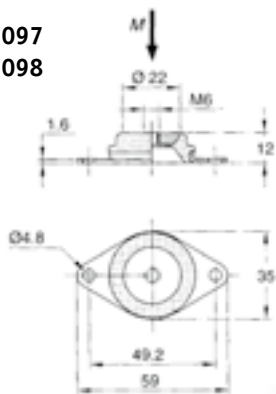

**Vibration Mounts**

These mounts are used in applications with low built-in heights. Horizontal and vertical stiffness are the same. Very suitable for generator sets, pump sets, compressors etc.

- Item Code 063097** 45°, M6 inner thread, max. load 120N  
Stiffness 75N/mm

- Item Code 063098** 60°, M6 inner thread, max. load 240N  
Stiffness 150N/mm

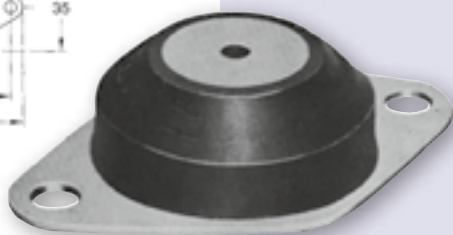

063099  
063100

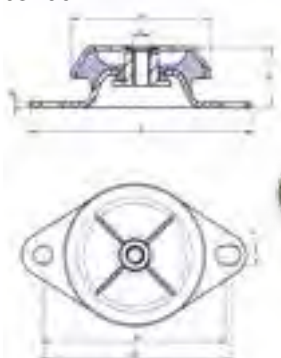

- Item Code 063099** 45°, M10 inner thread, max. load 300N  
Stiffness 90N/mm

- Item Code 063100** 60°, M8 inner thread, max. load 600N  
Stiffness 180N/mm

Dims.: A=50, B=25, C=M8, D1=63(min),  
D2=70(max), E=85, G=2 & F=6,5 mm





**For engines up to 257kW (350hp)**

Their special design offers different stiffnesses on the three axes. These anti vibration mounts have great vertical elasticity, great longitudinal stiffness and optimal lateral stiffness to offer extra isolation on this axis. Standard with engine height adjustment.

Item Code	Shore	Deflection	Max.load*	Pin
063040/S	40°	4,0mm	35kg	M12
063045/S	45°	4,0mm	45kg	M12
063046/S	45°	4,0mm	45kg	M16
063055/S	55°	4,0mm	70kg	M12
063056/S	55°	4,0mm	70kg	M16
063064/S	65°	3,7mm	95kg	M12
063065/S	65°	3,7mm	95kg	M16
063235/S	35°	5,1mm	95kg	M16
063245/S	45°	5,0mm	120kg	M16
063255/S	55°	5,0mm	220kg	M16
063265/S	65°	5,0mm	280kg	M16
063275/S	75°	5,0mm	400kg	M16
063345/S	45°	5,4mm	350kg	M20
063355/S	55°	5,4mm	525kg	M20
063365/S	65°	5,0mm	800kg	M20

\* max. load per mount!

Model	Dimensions							Weight kg
	A	B	C	D	F	J	G	
0630**	120	38,560	100	11	11	14	M-12	0,30
0632**	183	50	75	140	13	20	M-16	0,86
0633**	228	68	112	182	18	26	M-20	2,15



allpa®  
Anti  
Vibration  
Mounts

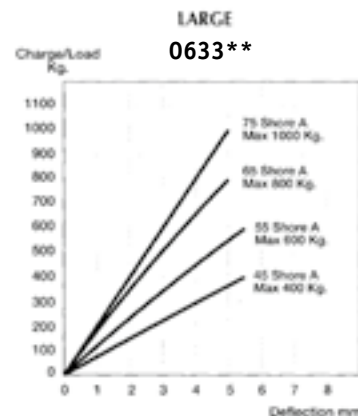
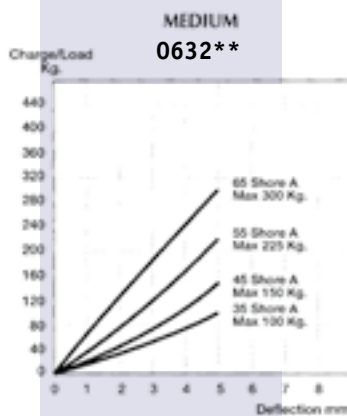
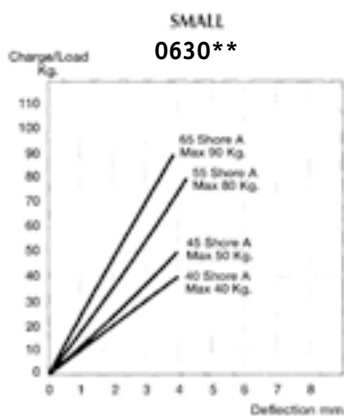
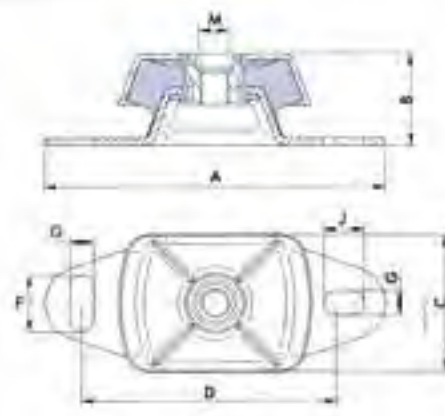

Height adjusting shims are used for the leveling of the marine engine. Made of anti corrosive steel plate in order to resist the marine environment. The shims have identical size and shape of the flexible marine mount feet and avoid the use of the traditional height adjusting studs which are subject to cyclic bending moments are exposed to eventual ruptures. Most of the marine certification companies do not recommend the use of height adjusting studs. Reference is made to DET NORSKE VERITAS (DNV) rules for ships / high speed Craft – issue January 2001, Pt.4 Ch3 Sec. 1 F202. This requirement is referred to rigid mounting, but is considered applicable this topic.

Code 063003	Shim for SMALL marine mount, H=3mm	HtH 100mm
Code 063204	Shim for MEDIUM marine mount, H= 4mm	HtH 1400mm
Code 063305	Shim for LARGE marine mount, H=5mm	HtH 182mm

Height adjusting  
shims





incl. cap nut

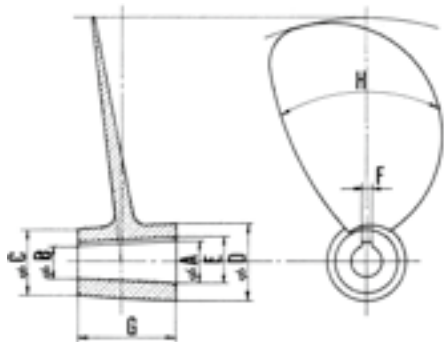

A	B	D	E	C	G	F
20	15.8	35	22.7	30	42	6
22	17.0	39	24.7	37	50	6
25	19.2	42	27.7	37	58	6
28	21.2	45	31.2	40	68	8
30	22.4	52	33.2	45	76	8
32	24.4	52	35.7	45	76	10
35	26.4	57	38.7	50	86	10
40	30.4	64	43.7	55	96	12
45	34.4	75	49.2	65	106	14
50	38.5	84	54.2	75	115	14
55	42.0	94	60.2	80	130	16
60	46.0	105	65.3	90	140	18
65	49.5	120	70.3	100	155	18
70	54.5	120	76.3	100	155	20

**Standard taper 1:10** All Propeller Shafts are completely machined and come with propeller nut with zinc anode, key and lock washer.

Item Code	Ø Shaft	Length
420100	20mm	1000mm
420150	20mm	1500mm
420200	20mm	2000mm
420250	20mm	2500mm
425100	25mm	1200mm
425150	25mm	1600mm
425200	25mm	2000mm
425250	25mm	2400mm
425300	25mm	3000mm
425350	25mm	3500mm
430100	30mm	1200mm
430150	30mm	1600mm
430200	30mm	2000mm
430250	30mm	2400mm
430300	30mm	3000mm
430350	30mm	3500mm
435100	35mm	1200mm
435150	35mm	1600mm
435200	35mm	2000mm
435250	35mm	2400mm
435300	35mm	3000mm
435350	35mm	3500mm
435400	35mm	4000mm
440150	40mm	1600mm
440200	40mm	2000mm
440250	40mm	2400mm
440300	40mm	3000mm
440350	40mm	3500mm
440400	40mm	4000mm

Item Code	Ø Shaft	Length
445150	45mm	1600mm
445200	45mm	2000mm
445250	45mm	2400mm
445300	45mm	3000mm
445350	45mm	3500mm
445400	45mm	4000mm
450150	50mm	1500mm
450200	50mm	2000mm
450250	50mm	2500mm
450300	50mm	3000mm
450350	50mm	3500mm
450400	50mm	4000mm
455150	55mm	1500mm
455200	55mm	2000mm
455250	55mm	2500mm
455300	55mm	3000mm
455350	55mm	3500mm
455400	55mm	4000mm
460150	60mm	1500mm
460200	60mm	2000mm
460250	60mm	2500mm
460300	60mm	3000mm
460350	60mm	3500mm
460400	60mm	4000mm

**Propeller Shafts  
Stainless Steel  
AISI 329**

**Key Sizes (wxhxl in mm):**

Shaft 20mm:	6x6x30	<b>Item Code 31100100</b>
Shaft 25mm:	6x6x40	<b>Item Code 31100700</b>
Shaft 30mm:	8x7x55	<b>Item Code 31100800</b>
Shaft 35mm:	10x8x70	<b>Item Code 31100900</b>
Shaft 40mm:	12x8x82	<b>Item Code 31101000</b>
Shaft 45mm:	14x9x88	<b>Item Code 31101100</b>
Shaft 50mm:	14x9x88	<b>Item Code 31101100</b>
Shaft 55mm:	16x10x100	<b>Item Code 31101400</b>
Shaft 60mm:	18x11x118	<b>Item Code 31101600</b>

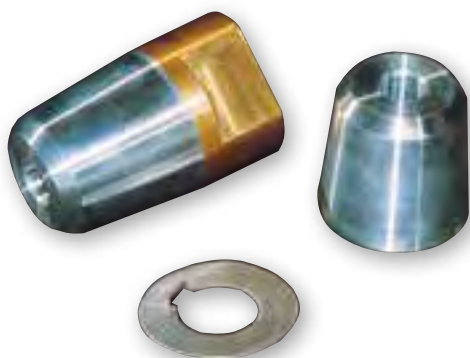

**allpa® Propeller  
Nuts with Zinc  
Anode**

Complete nut Item Code	Shaft (mm)	Thread	Zink only Item Code	Lock Washer Item Code
465020	20	M12 x 1,5	465120	465220
465025	25	M16 x 1,5	465125	465225
465030	30	M20 x 1,5	465130	465230
465035	35/40	M24 x 2	465135	465235
465040	40	M27 x 2	465140	465240
465045	45	M33 x 2	465145	465245
465045/30	45	M30 x 2	465145	465245/30
465050	50	M36 x 3	465150	465250
465055	55	M40 x 3	465155	465255
465060	60	M45 x 3	465160	465260

For aluminum anode,  
see p. 136

# allpa Components for Propeller Shaft Systems

## Stern Bearings

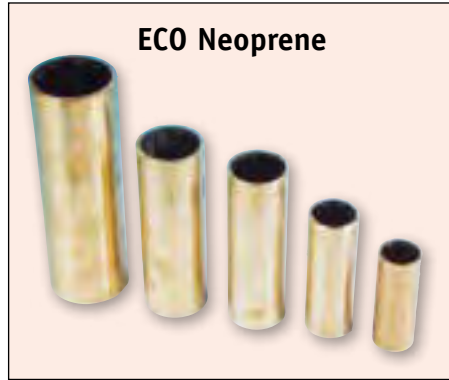

## Stern Tubes

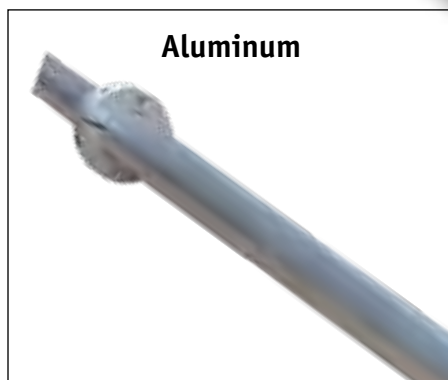

## Inner Bearing



**Accessories/Options:**  
 Intermediate Bearing Bronze, threaded  
 Intermediate Bearing Phenol, for Glassfiber Tube  
 Intermediate Bearing Phenol, for Aluminum Tube  
 Propeller Shaft: See p. 568 to 579



## allpa Propeller Shaft Assembly SET-K1



<b>Item Code</b> 176125	SET-K1 with Ø25mm propeller shaft
<b>Item Code</b> 176130	SET-K1 with Ø30mm propeller shaft
<b>Item Code</b> 176135	SET-K1 with Ø35mm propeller shaft
<b>Item Code</b> 176140	SET-K1 with Ø40mm propeller shaft



### Assembly SET-K1 consists of:

- Stainless Steel Propeller shaft L=2000mm, with nut and zinc anode, security washer and shaft key
- Glass fiber stern tube L=1200mm with neoprene bearing
- Rubber inner bearing with dual lip seal and water intake

### Option:

- Phenolic Intermediate bearing (See p. 576)

## allpa Propeller Shaft Assembly SET-K2



<b>Item Code</b> 176225	SET-K2 with Ø25mm propeller shaft
<b>Item Code</b> 176230	SET-K2 with Ø30mm propeller shaft
<b>Item Code</b> 176235	SET-K2 with Ø35mm propeller shaft



### Assembly SET-K2 consists of:

- Stainless Steel Propeller shaft L=2000mm, with nut and zinc anode, security washer and shaft key
- Aluminum stern tube L=1500mm with neoprene bearing and mounting flange
- Rubber inner bearing with dual lip seal and water intake

### Extra:

- Phenolic Intermediate bearing (See p. 576)

## allpa Propeller Shaft Assembly SET-K3



**Item Code 176325** SET-K3 with Ø25mm propeller shaft  
**Item Code 176330** SET-K3 with Ø30mm propeller shaft

### Assembly SET-K3 consists of:

- RVS Propeller shaft L=2000mm, with nut and zinc anode, security washer and shaft key
- Bronze stern tube L=1500mm with neoprene bearing and mounting flanges
- Rubber inner bearing with lip seals and water intake

### Extra:

- Intermediate Bearing Phenol (See page 576)



## allpa Propeller Shaft Assembly SET-K4



**Item Code 176435** SET-K4 with Ø35mm propeller shaft  
**Item Code 176440** SET-K4 with Ø40mm propeller shaft

### Assembly SET-K4 consists of:

- RVS Propeller shaft L=2400mm, with nut and zinc anode, security washer and shaft key
- Bronze stern tube L=1800mm
- Bronze, threaded, outer bearing with mounting flange
- Bronze, threaded, intermediate bearing on L=1200mm from propeller side
- Rubber inner bearing with lip seals and water intake



## allpa Propeller Shaft Assembly SET-K5

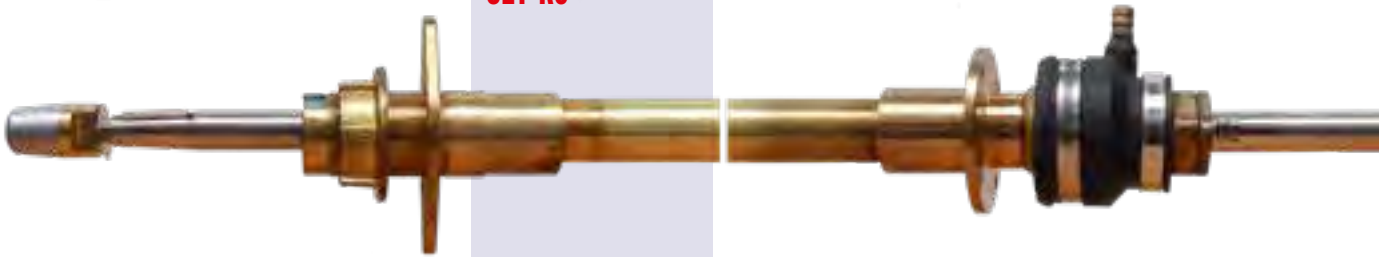

**Item Code 176535** SET-K5 with Ø35mm propeller shaft  
**Item Code 176540** SET-K5 with Ø40mm propeller shaft

### Assembly SET-K5 consists of:

- RVS Propeller shaft L=2000mm, with nut and zinc anode, security washer and shaft key
- Bronze stern tube L=1600mm
- Bronze, threaded, outer bearing with mounting flange
- Bronze, threaded, flexible inner bearing with greased cotton packing and water intake
- Rubber inner bearing with lip seals and water intake

### Extra:

- Bronze, threaded, intermediate bearing (for longer stern tubes) (See p. 576)



## Stern Tubes

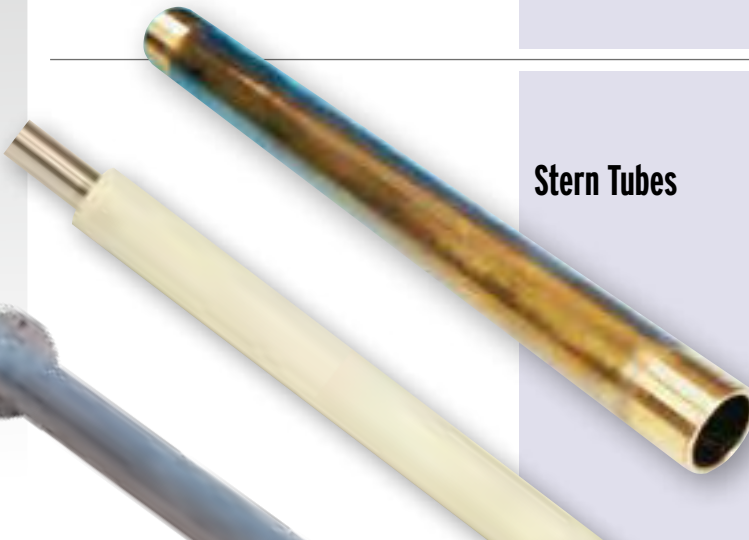

Item Code	Material	Shaft	Tube Size	Length	Remarks
OT6325	Brass	Ø25mm	40 x 34mm	per meter	Thread machined 1- or 2-sides
OT6330	Brass	Ø30mm	45 x 39mm	per meter	Thread machined 1- or 2-sides
OT6335	Brass	Ø35mm	50 x 43mm	per meter	Thread machined 1- or 2-sides
OT6340	Brass	Ø40mm	55 x 45mm	per meter	Thread machined 1- or 2-sides
OT0125P	Fiberglass	Ø25mm	43 x 35mm	1200mm	Compl. w.neoprene bearing w. brass shell
OT0130P	Fiberglass	Ø30mm	49 x 40mm	1200mm	Compl. w.neoprene bearing w. brass shell
OT0135P	Fiberglass	Ø35mm	55 x 47mm	1200mm	Compl. w.neoprene bearing w. brass shell
OT0140P	Fiberglass	Ø40mm	60 x 52mm	1200mm	Compl. w.neoprene bearing w. brass shell
OT0145P	Fiberglass	Ø45mm	65 x 56mm	1200mm	Compl. w.neoprene bearing w. brass shell
042825	Aluminum	Ø25mm	45 x 35mm	1500mm	Compl. w.neoprene bearing w. brass shell
042830	Aluminum	Ø30mm	50 x 40mm	1500mm	Compl. w.neoprene bearing w. brass shell
042835	Aluminum	Ø35mm	60 x 44mm	1500mm	Compl. w.neoprene bearing w. brass shell



Radice rubber propeller shaft seal for water-lubricated shaft logs with water intake and separate grease inlet to lubricate the double lip seal.

This shaft seal consists of a flexible sleeve with shaft bearing and S/S hose clamp. Includes a tube of silicon grease and a mounting aid too.

Temperature range: seals -10° to +80° C, sleeve: -20° to +140° C.

Water intake Ø10mm (for water scoop!)

Minimal friction. Oil and grease resistant.

<b>Radice Rubber Propeller Shaft Seal with water- and grease inlet</b>				
Item Code	Ø Shaft	Ø Tube	L-1	L-2
463422	22mm	39mm	111mm	38mm
463425	25mm	39mm	111mm	38mm
463425/P	25mm	42mm	111mm	38mm
463430	30mm	45mm	116mm	38mm
463430/P	30mm	48mm	116mm	38mm
463435	35mm	48mm	123mm	38mm
463435/P	35mm	54mm	123mm	38mm
463440	40mm	54mm	129mm	38mm
463440/P	40mm	60mm	129mm	38mm
467100	Spare tube silicon grease			

## Radice Rubber Propeller Shaft Seal

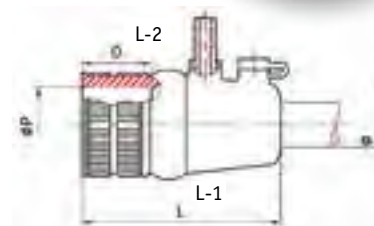

allpa rubber propeller shaft seal for water-lubricated shaft logs. Also available with water intake and separate grease inlet to lubricate the double lip seal.

This shaft seal consists of a flexible sleeve with shaft bearing and S/S hose clamp. Includes a tube of silicon grease and a mounting aid too.

Temperature range: seals -10° to +80° C, sleeve: -20° to +140° C.

Water intake Ø10mm (for water scoop!)

Minimal friction. Oil and grease resistant.

<b>allpa Rubber Propeller Shaft Seal</b>				
Item Code	Ø Shaft	Ø Tube	L-1	L-2
463225	25mm	43mm	102mm	38mm
463230	30mm	47mm	112mm	38mm
463235	35mm	54mm	121mm	38mm
463240	40mm	59,5mm	121mm	38mm
463245	45mm	62mm	121mm	38mm
463250	50mm	65mm	129mm	38mm
<b>allpa Rubber Propeller Shaft Seal with water- and grease inlet</b>				
Item Code	Ø Shaft	Ø Tube	L-1	L-2
463226	25mm	43mm	102mm	38mm
463231	30mm	49mm	112mm	38mm
463236	35mm	55mm	121mm	38mm
463241	40mm	59,5mm	121mm	38mm

## allpa Rubber Propeller Shaft Seal



## allpa - PSS - Packless Sealing System

- DRIPLESS OPERATION
- LOW MAINTENANCE
- REDUCED COSTS
- RINA, ABS AND BUREAU VERITAS CERTIFIED

Maintenance free axial propeller shaft sealing system. Specially developed for water lubricated propeller shaft assemblies. No stuffing box, no greased cotton sealing rings or lip seals. This mechanical sealing system consists of a carbon cuff, a stainless steel rotor and a rubber sleeve. Temperature range -70 °C till +220 °C.

This carbon cuff is attached to the stern tube by the rubber sleeve. The elasticity of this sleeve allows the carbon cuff to be pressed against the stainless steel rotor. Due to the permanent contact of the carbon cuff with the stainless steel ring, the sealing surface remains very smooth providing perfect sealing. The stainless steel ring rotates with the propeller shaft. This ring is mounted on the shaft with two allen screws and O-rings. The axial sealing surface is very wide thus providing perfect sealing even with vibrating propeller shafts. The rubber sleeve is resistant to oil and grease and is available in a wide range of sizes.

Item Code	Ø Shaft	Ø Tube		Length	
		inch	mm	inch	mm
036222114	22	1-1/4	31,8	6-1/4	158
036222112	22	1-1/2	38,1	6-1/4	158
036225112	25	1-1/2	38,1	6-1/4	158
036225134	25	1-3/4	44,5	6-1/4	158
036230134	30	1-3/4	44,5	6-1/4	158
036230200	30	2	50,8	6-1/4	158
036230214	30	2-1/4	57,2	6-1/4	158
036232200	32	2	50,8	6-1/2	165
036232214	32	2-1/4	57,2	6-1/2	165
036232212	32	2-1/2	63,5	6-1/2	165
036235200	35	2	50,8	6-1/2	165
036235214	35	2-1/4	57,2	6-1/2	165
036235212	35	2-1/2	63,5	6-1/2	165
036238212	38	2-1/2	63,5	8-1/8	206
036240200	40	2	50,8	8-1/8	206
036240214	40	2-1/4	57,2	8-1/8	206
036240212	40	2-1/2	63,5	8-1/8	206
036240234	40	2-3/4	69,9	8-1/8	206
036245214	45	2-1/4	57,2	8-1/8	206
036245212	45	2-1/2	63,5	8-1/8	206
036245234	45	2-3/4	69,9	8-1/8	206
036250212	50	2-1/2	63,5	8-1/8	206
036250234	50	2-3/4	69,9	8-1/8	206
036250300	50	3	76,2	8-1/8	206
036250314	50	3-1/4	82,6	8-1/8	206
036250312	50	3-1/2	88,9	8-1/8	206
036255300	55	3	76,2	8-1/8	206
036255314	55	3-1/4	82,6	8-1/8	206
036255312	55	3-1/2	88,9	8-1/8	206
036260314	60	3-1/4	82,6	8-1/2	216
036260312	60	3-1/2	88,9	8-1/2	216
036260334	60	3-3/4	95,3	8-1/2	216
036260500	60	5	127,0	9-1/8	232
036270412	70	4-1/2	114,3	9-1/4	235
036270500	70	5	127,0	9-1/4	235
036280412	80	4-1/2	114,3	9-1/4	235
036295600	95	6	152,4	9-3/4	248

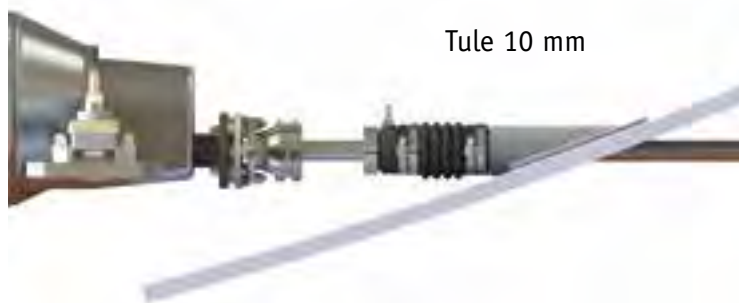

Also available for propeller shaft diameters with inch sizes.

Nitrile O-rings & S/S screws - kits:

Code 036000022	22mm	Code 036000045	45mm
Code 036000025	25mm	Code 036000050	50mm
Code 036000030	30mm	Code 036000055	55mm
Code 036000032	32mm	Code 036000060	60mm
Code 036000035	35mm	Code 036000070	70mm
Code 036000040	40mm	Code 036000080	80mm

Voor afwijkende maatcombinaties kan de rubberbalg aangepast worden met de volgende reduceerringen:

Item Code 036200134	2" naar 1-3/4"
Item Code 036212214	2-1/2" naar 2-1/4"
Item Code 036214200	2-1/4" naar 2"
Item Code 036300234	3" naar 2-3/4"



allpa - PSS mechanical seals are available from 22mm to 95mm (type A) and from 100mm to 150mm (type B)



Water lubricated self-aligning bronze inner bearing with rubber sleeve and dual lip seal. Complete with adjustable mounting flange for stern tube.

The bearing comes with spare seals.

**Item Code 042540** For propeller shaft 25mm and stern tube 40mm

**Item Code 043045** For propeller shaft 30mm and stern tube 45mm

**Item Code 043550** For propeller shaft 35mm and stern tube 50mm

**Item Code 044055** For propeller shaft 40mm and stern tube 55mm

**Item Code 042541** Lipseal 25mm = 1 set of 2 seals + grease

**Item Code 043046** Lipseal 30mm = 1 set of 2 seals + grease

**Item Code 043551** Lipseal 35mm = 1 set of 2 seals + grease

**Item Code 044056** Lipseal 40mm = 1 set of 2 seals + grease

A	B	C	D	E
184	32	80	25	40
184	32	80	30	45
189	32	90	35	55
189	32	90	40	55

All length in mm.



### Inner Bearings with Dual Lip Seal

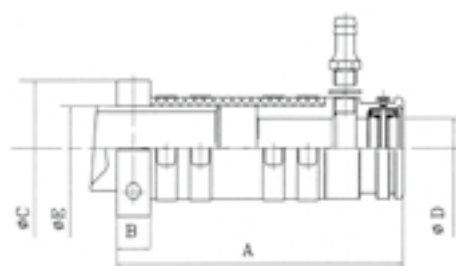

The latest development in this field. This mechanical seal definitely prevents any propeller shaft drip in the bilge. The system consists of a non-rotating carbon cuff joined to the stern tube by means of a rubber bellow and a stainless steel rotor fixed on the propeller shaft. The tension of the bellow, with the help of water pressure, produces a constant contact between the carbon cuff and the stainless steel rotor resulting in a drip free propeller shaft seal.

A neoprene bearing incorporated in the bellow aligns both bearing surfaces and reduces shaft vibrations.

Once installed, it does not require any adjustment. Remarkable disalignment is allowed, both axial and angular.

Available for propeller shaft diameters of 25, 30, 35 and 40mm.

	A	B*	D	E (mm)
<b>Item Code 040125</b>	210	190	25	40
<b>Item Code 040130</b>	210	190	30	45
<b>Item Code 040135</b>	255	235	35	50
<b>Item Code 040140</b>	255	235	40	55

\* B = A - 20mm, ± 0-5mm (= bellow pre-tension)



### TMF Axial Propeller Shaft Seals

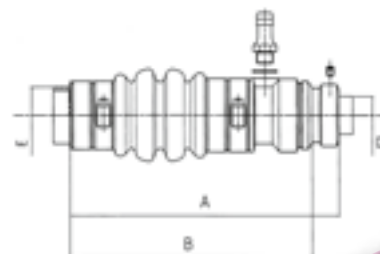

Kit with grated water scoop, ball valve, hose pillar and 1m of water hose with hose clamps

**Item Code 013012** Kit with 12mm hose

**Item Code 013015** Kit with 14mm hose

**Item Code 013019** Kit with 19mm hose

### Water Scoop Kit



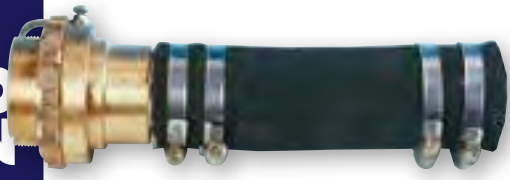

### Self-aligning Inner Bearings

Bronze inner bearing with stuffing box and sleeve

**Item Code TF30-Set** for shaft Ø30mm

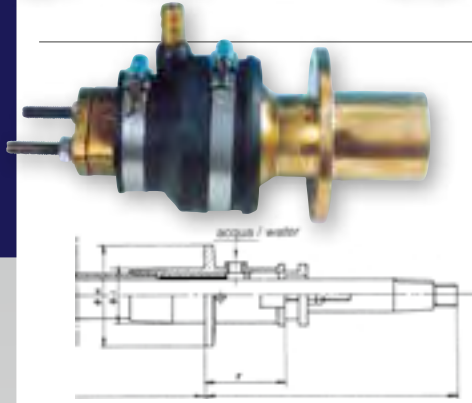

### Self-aligning Inner Bearings

Water lubricated, bronze inner bearing with stuffing box and rubber sleeve. Integrated neoprene bearing and inner thread for stern tube.

**Item Code**                      **Dimensions (mm)**

	Øshaft	F	H	I	N
463125	25	135	100	52	45
463130	30	135	100	52	45
463135	35	150	120	62	80
463140	40	150	120	62	80
463145	45	175	140	74	80
463150	50	175	140	74	80

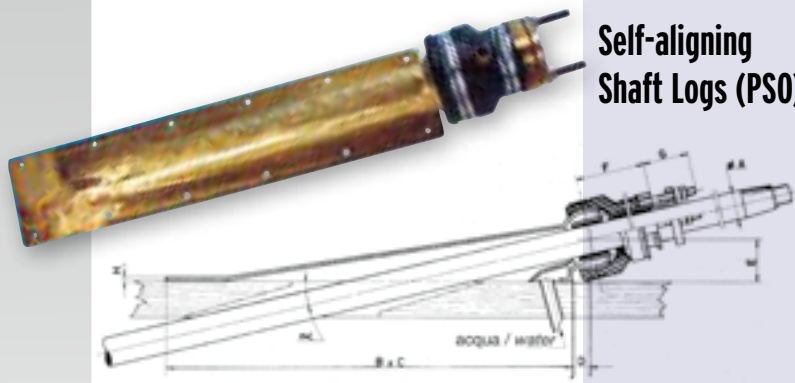

### Self-aligning Shaft Logs (PS0)

Self-aligning bronze shaft log with inner bearing and stuffing box with rubber sleeve. Installation angle see table. For wooden boats.

**Item Code**                      **Dimensions**

	Øshaft	a°	B	C	D	E	F	G	H
464225	25	9°-17°	460	90	20	48	77	45	5
464230	30	9°-17°	460	90	20	48	77	45	5
464235	35	11°-17°	500	110	27	60	86	103	5
464240	40	11°-17°	500	110	27	60	86	103	5
464245	45	11°-15°	555	130	35	66	103	75	5
464250	50	11°-15°	555	130	35	66	103	75	5

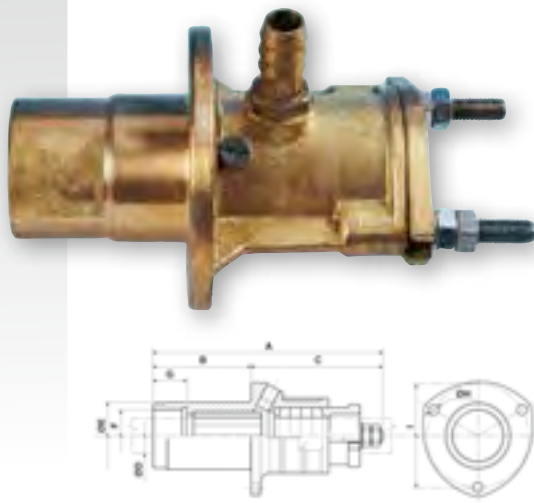

### Rigid Inner Bearings

Water lubricated bronze inner bearing with stuffing box and inner thread for stern tube

**Item Code**                      **Dimensions (mm)**

	A	B	C	D	E	F	G	H	I
562001	153	61	92	20	42	M35x1,5	25	5	62
562002	175	70	105	25	48	M40x1,5	25	7	72
562003	187	84	103	30	54	M45x1,5	30	7	80
562004	197	94	103	35	61	M50x1,5	30	9	90
562005	206	113	150	40	68	M55x2	40	10,5	108
562006	283	133	150	45	74	M60x2	50	10,5	115
562007	310	155	150	50	80	M65x2	60	10,5	120
562009	340	170	170	60	96	M80x2	60	10,5	135



### Phenolic Intermediate Bearings

**Item Code 308031/N** Shaft Ø25mm-D=40x35mm, L=100mm

**Item Code 308032** Shaft Ø30mm-D=45x39mm, L=60mm

**Item Code 308032/N** Shaft Ø30mm-D=45x40mm, L=60mm

**Item Code 308033** Shaft Ø35mm-D=50x43mm, L=70mm

**Item Code 308034** Shaft Ø40mm-D=55x45mm, L=80mm



### Intermediate Neoprene Shaft Bearings with Internal Thread

**Item Code 040025** for shaft Ø25mm (Thread M40 x 1,5)

**Item Code 040030** for shaft Ø30mm (Thread M45 x 1,5)

**Item Code 040035** for shaft Ø35mm (Thread M50 x 1,5)

**Item Code 040040** for shaft Ø40mm (Thread M55 x 2)

**Item Code 040045** for shaft Ø45mm (Thread M60 x 2)

**Item Code 040050** for shaft Ø50mm (Thread M65 x 2)

Item Code	Dimensions (mm)								
	A	B	C	∅D	∅E	F	G	∅H	I
562019	110	45-55	25	20	42	M35x1,5	105	5	65
562020	129	45-75	25	25	48	M40x1,5	110	7	75
562021	153	55-85	20	30	54	M45x1,5	125	7	85
562022	175	65-95	20	35	61	M50x1,5	150	8,5	95
562023	206	70-100	40	40	68	M55x2	165	10,5	110
562024	236	75-105	50	45	74	M60x2	175	10,5	112
562025	266	80-110	60	50	80	M65x2	180	10,5	120
562027	308	80-110	60	60	96	M80x2	175	10,5	140

Bronze outer bearings with flange and nut and inner thread for stern tube.

### Outer Bearings

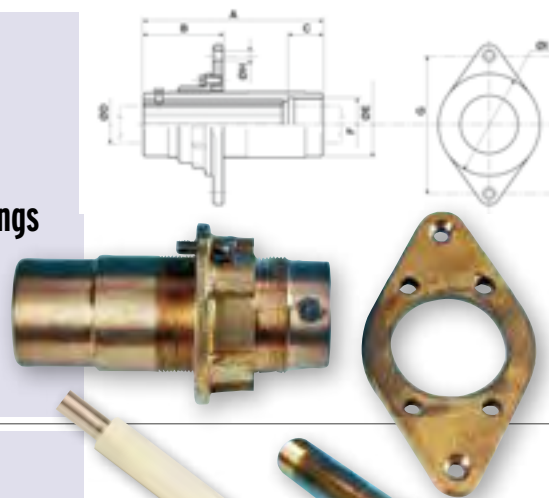

For Stern Tubes: Please see p. 572

### Brass Stern tubes



Item Code 052025	Flange for tube ∅40mm (shaft ∅25mm)
Item Code 052030	Flange for tube ∅45mm (shaft ∅30mm)
Item Code 052035	Flange for tube ∅50mm (shaft ∅35mm)
Item Code 052040	Flange for tube ∅55mm (shaft ∅40mm)

### Adjustable Mounting Flanges for SternTube



Bronze shaft struts with neoprene bearing  
For polyester and wood-epoxy boats

Item Code	Dimensions (mm)				
	∅shaft	B ± W0,05	D	G	H
468025	25	38,10	102	220	400
468030	30	44,45	130	220	400
468035	35	47,62	140	260	450
468040	40	53,97	165	280	450
468045	45	60,32	180	330	550
468050	50	66,67	205	350	550
468060	60	82,55	255	400	670

### Propeller Shaft Struts



Bronze struts with straight mounting flange and neoprene bearing These struts are supplied on special order only, according to specifications and in minimum quantities  
Variable specifications are:

- H, height of the strut
- $\alpha^\circ$ , the longitudinal angle of the bearing
- $\beta^\circ$ , the lateral angle of the strut

Dimensions (mm)								
∅shaft	B ± W0,05	D	E	F	Hmax	∅S	$\alpha^\circ$	$\beta^\circ$
25	38,10	102	130	110	180	8	9-16	0-22
30	44,45	130	160	130	200	10	9-16	0-22
35	47,62	140	185	155	230	10	9-16	0-22
40	53,97	165	210	175	260	12	9-16	0-22
45	60,32	180	235	195	300	12	9-16	0-22
50	66,67	205	260	220	350	12	9-16	0-22
60	82,55	255	340	270	400	16	6-15	0-20
70	95,25	295	400	310	450	16	6-15	0-18
80	101,60	320	455	355	500	16	6-15	0-18
90	114,30	380	510	400	550	20	5-14	0-16
100	133,35	430	565	455	600	20	5-14	0-16

### Propeller Shaft Struts with mounting Flange

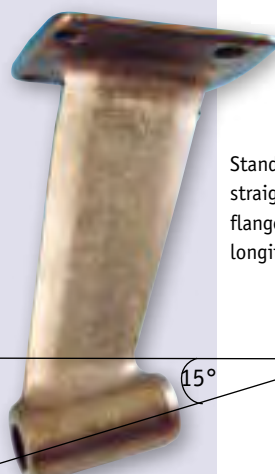
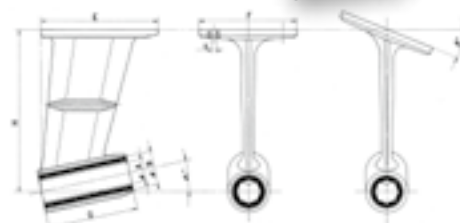

Standard struts have straight mounting flange and 15° longitudinal angle

Item Code	∅Shaft (mm)
468125	25
468130	30
468135	35
468140	40
468145	45
468150	50
468160	60



Neoprene Bearings

**Neoprene bearings with resin outer shell**

Code	Øshaft	Øouter(mm)	Length(mm)
428025	25	38,10 (1 1/2")	101,60 (4")
428030	30	44,45 (1 3/4")	127,00 (5")
428035	35	47,62 (1 7/8")	139,70 (5 1/2")
428040	40	53,97 (2 1/8")	165,10 (6 1/2")
428045	45	60,32 (2 3/8")	177,80 (7")
428050	50	66,67 (2 5/8")	203,20 (8")
428055	55	76,20 (3")	228,60 (9")
428060	60	82,55 (3 1/4")	241,30 (9 1/2")



Neoprene Bearings

**Neoprene bearings with brass outer shell**

Code	Øshaft	Øouter(mm)	Length(mm)
408022	22	31,75 (1 1/4")	76,20 (3")
408025	25	38,10 (1 1/2")	101,60 (4")
408030	30	44,45 (1 3/4")	127,00 (5")
408035	35	47,62 (1 7/8")	139,70 (5 1/2")
408040	40	53,97 (2 1/8")	165,10 (6 1/2")
408045	45	60,32 (2 3/8")	177,80 (7")
408050	50	66,67 (2 5/8")	203,20 (8")
408055	55	76,20 (3")	228,60 (9")
408060	60	82,55 (3 1/4")	241,30 (9 1/2")
408065	65	85,72 (3 3/8")	266,70 (10 1/2")
408070	70	95,25 (3 3/4")	279,40 (11")
408075	75	101,60 (4")	304,80 (12")
408080	80	101,60 (4")	304,80 (12")
408090	90	114,30 (4 1/2")	355,60 (14")



Neoprene Bearings

**Neoprene bearings with brass outer shell**

Code	Øshaft(mm)	Øouter(mm)	Length(mm)
308006	25	35	100
308008	30	40	120
308010	35	48	140
308012	40	56	160
308014	45	61	180
308016	50	66	200
308047	55	73	220
308049	60	78	240

**Neoprene bearings with aluminum outer shell**

Code	Øshaft(mm)	Øouter(mm)	Length(mm)
308106	25	35	100
308108	30	40	120
308110	35	48	140
308112	40	56	160
308114	45	61	180
308116	50	66	200



Neoprene Bearings

**Neoprene bearings with brass outer shell**

Code	Øshaft(°)	Øouter(°)	Length(°)	Code	Øshaft(°)	Øouter(°)	Length(°)
418001	1	1 1/2	4	418013	2 1/2	3 1/4	10
418002	1 1/8	1 5/8	4 1/2	418015	2 3/4	3 3/4	11
418003	1 1/4	1 3/4	5	418017	3	4	12
418004	1 3/8	1 7/8	5 1/2	418018	3 1/4	4	12
418005	1 1/2	2	6	418019	3 3/8	4 1/2	13 1/2
418007	1 3/4	2 3/8	7	418020	3 1/2	4 1/2	14
418009	2	2 5/8	8	418021	3 5/8	4 1/2	14 1/2
418010	2 1/8	3	8 1/2	418022	3 3/4	4 1/2	15
418011	2 1/4	3	9	418024	4	5 1/4	16
418012	2 3/8	3 1/4	9 1/2				



# allpa Custom-Made Installations Our Specialization!

Please contact allpa through [inboard@allpa.eu](mailto:inboard@allpa.eu) for technical solutions.

## Propeller Calculation

For propeller calculation the following data is needed:

- Type of boat: displacement type, semi-planing or planning
- Hull material
- Displacement of the boat
- Length waterline - Width waterline - Depth without keel
- Brand and type of engine
- Engine power and max. rpm
- Ratio of the gearbox
- Sense of rotation of the propeller
- Estimated max. speed of the boat
- Maximum diameter of the propeller
- Propeller Shaft diameter and cone or Sail Drive Model
- Desired propeller: 2-blade, 3-blade, 4-blade, foldingpropeller 2-blade or 3-blade

Propellers with non standard dimensions or taper are available with a delivery time of 10 working weeks.



Radice Propellers

2-Blade manganese bronze boat propellers



2-Blade Model K-11			
Fa/F 0,34			
P/D Max 0,9			
Diameter:		Pitch	Max. Ø Shaft
Ø mm	Ø Inch		
305	12	8 tot 10"	25mm
330	13	8 tot 13"	25mm
355	14	8 tot 14"	25mm
380	15	8 tot 14"	25mm
405	16	8 tot 15"	30mm
430	17	10 tot 15"	30mm
455	18	10 tot 15"	30mm
480	19	13 tot 15"	35mm
505	20	13 tot 14"	35mm
535	21	13 tot 14"	35mm
560	22	-	-
585	23	-	-
610	24	-	-
Boat Type		Displacement Vessel	
Speed		6/10Kn	

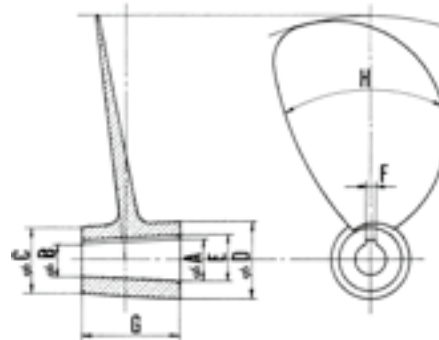
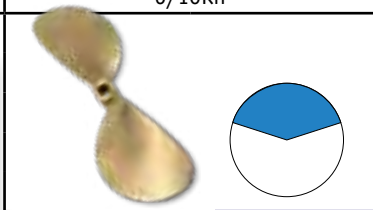

	Ø mm	Ø inches
	305	12
	330	13
	355	14
	380	15
	405	16
	430	17
	455	18
	480	19
	505	20
	535	21
	560	22
	585	23
	610	24
	635	25
	660	26
	685	27
	710	28
	735	29
	760	30

A	B	D	E	C	G	F
20	15.8	35	22.7	30	42	6
22	17.0	39	24.7	37	50	6
25	19.2	42	27.7	37	58	6
28	21.2	45	31.2	40	68	8
30	22.4	52	33.2	45	76	8
32	24.4	52	35.7	45	76	10
35	26.4	57	38.7	50	86	10
40	30.4	64	43.7	55	96	12
45	34.4	75	49.2	65	106	14
50	38.5	84	54.2	75	115	14
55	42.0	94	60.2	80	130	16
60	46.0	105	65.3	90	140	18
65	49.5	120	70.3	100	155	18
70	54.5	120	76.3	100	155	20

Available in diameters from 12" up to 21".

Standard Stock Propellers are:

Item Code	
2120825R	2141225R
2120925R	2151125R
2130925R	2151225R
2131025R	2161125R
2131125R	2161225R
2140825R	2161325R
2140925R	2161425R
2141025R	2181125R
2141125R	2181330R

How to order (for example) 2-12-09-25-R:

No. of blades	Diameter	Pitch	Ø Shaft	Rotation
2	12"	09"	25	R

# Radice Propellers

## 3-Blade manganese bronze boat propellers type E-13

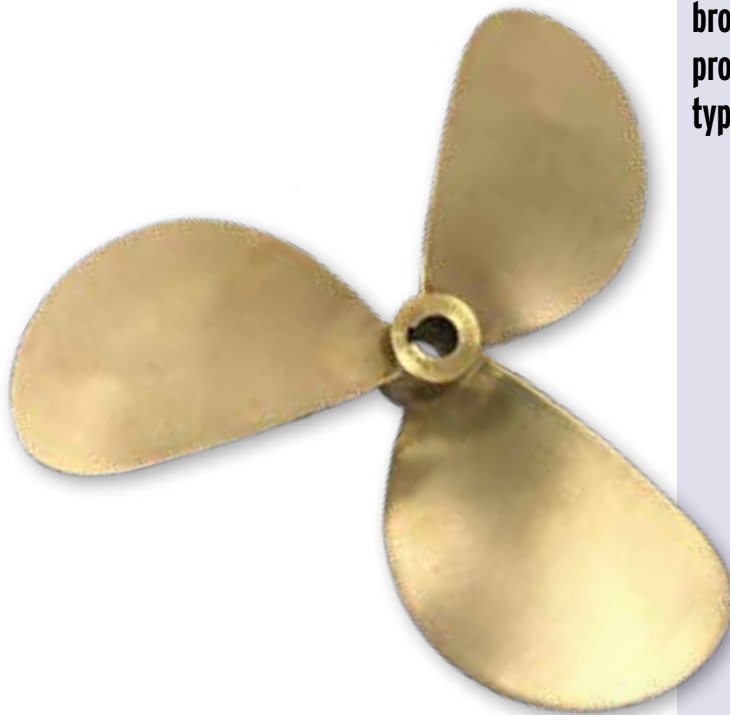

E 13 Fa/F AS/AD = 0.5150

3-Blade Model E-13			
Fa/F 0,515			
Diameter:		P/D Max 0,85	
Ø mm	Ø Inch	Pitch	Max. Ø Shaft
305	12	8 tot 11"	25mm
330	13	8 tot 13"	30mm
355	14	8 tot 14"	30mm
380	15	8 tot 14"	35mm
405	16	9 tot 16"	35mm
430	17	10 tot 16"	35mm
455	18	10 tot 16 "	40mm
480	19	11 tot 18"	40mm
505	20	11 tot 18"	45mm
535	21	12 tot 19"	45mm
560	22	12 tot 19"	45mm
585	23	15 tot 19"	45mm
610	24	15 tot 17"	45mm
Boat Type		Displacement Vessel	
Speed		8/16Kn	

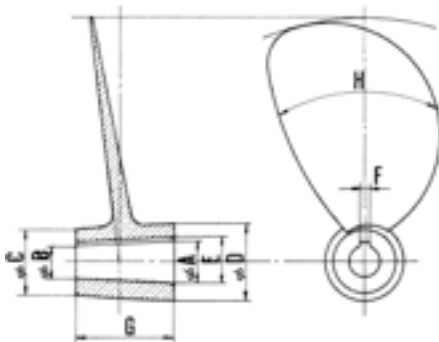

Ø mm	Ø inches
305	12
330	13
355	14
380	15
405	16
430	17
455	18
480	19
505	20
535	21
560	22
585	23
610	24
635	25
660	26
685	27
710	28
735	29
760	30

A	B	D	E	C	G	F
20	15.8	35	22.7	30	42	6
22	17.0	39	24.7	37	50	6
25	19.2	42	27.7	37	58	6
28	21.2	45	31.2	40	68	8
30	22.4	52	33.2	45	76	8
32	24.4	52	35.7	45	76	10
35	26.4	57	38.7	50	86	10
40	30.4	64	43.7	55	96	12
45	34.4	75	49.2	65	106	14
50	38.5	84	54.2	75	115	14
55	42.0	94	60.2	80	130	16
60	46.0	105	65.3	90	140	18
65	49.5	120	70.3	100	155	18
70	54.5	120	76.3	100	155	20

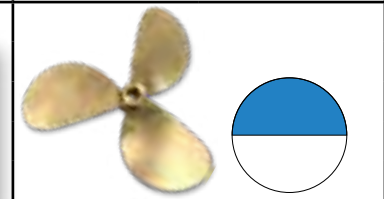

**Available in diameters from 12" up to 24".**

Standard stock propellers are:

### Item Code

3120725R	3151125R	3171235R
3120825R	3151130R	3171325R
3121025R	3151225L	3171330R
3130725R	3151225R	3171530R
3130825R	3151325L	3181235R
3130925R	3151325R	3181330R
3131025R	3151330R	3181335R
3131125R	3151425R	3181340R
3131225R	3151430R	3181430R
3140825R	3161025R	3181530R
3140925R	3161125R	3191335R
3140930R	3161130R	3191430R
3141025R	3161225L	3191435R
3141030R	3161225R	3191535R
3141125R	3161230R	3201435R
3141225R	3161325R	3211430R
3150925R	3161330R	3221430R
3151025R	3161430R	3221435R
3151030R	3171130R	3221440R

### How to order (for example) 3-12-08-25-R:

No. of blades	Diameter	Pitch	Ø Shaft	Rotation
3	12"	08"	25	R

Radice Propellers

3-Blade manganese bronze boat propellers type C-7



3-Blade Model C-7			
Fa/F 0,55			
Diameter:		P/D Max 1,2	
Ø mm	Ø Inch	Pitch	Max. Ø Shaft
305	12	-	-
330	13	11 tot 15"	25mm
355	14	11 tot 17"	25mm
380	15	13 tot 17"	30mm
405	16	14 tot 20"	35mm
430	17	15 tot 20"	35mm
455	18	15 tot 21"	40mm
480	19	15 tot 23"	40mm
505	20	16 tot 23"	40mm
535	21	-	-
560	22	-	-
585	23	-	-
610	24	-	-
Boat Type		Semi Planing / Planing Vessel	
Speed		17/30Kn	

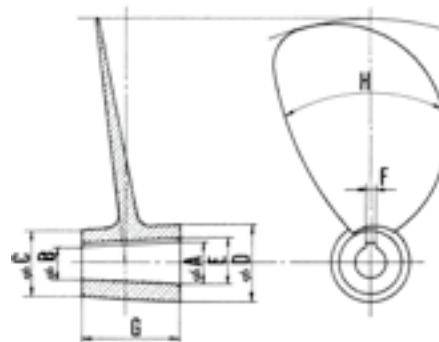
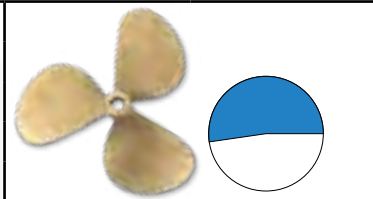

Ø mm	Ø inches
305	12
330	13
355	14
380	15
405	16
430	17
455	18
480	19
505	20
535	21
560	22
585	23
610	24
635	25
660	26
685	27
710	28
735	29
760	30

A	B	D	E	C	G	F
20	15.8	35	22.7	30	42	6
22	17.0	39	24.7	37	50	6
25	19.2	42	27.7	37	58	6
28	21.2	45	31.2	40	68	8
30	22.4	52	33.2	45	76	8
32	24.4	52	35.7	45	76	10
35	26.4	57	38.7	50	86	10
40	30.4	64	43.7	55	96	12
45	34.4	75	49.2	65	106	14
50	38.5	84	54.2	75	115	14
55	42.0	94	60.2	80	130	16
60	46.0	105	65.3	90	140	18
65	49.5	120	70.3	100	155	18
70	54.5	120	76.3	100	155	20

Available in diameters from 13" up to 20".

Please contact allpa for actual availability.

Standard Stock Propellers are:

Item Code

- 3141025RC7
- 3151025RC7
- 3151030RC7
- 3151225RC7
- 3151230RC7
- 3161330RC7
- 3161435RC7
- 3171235RC7
- 3181235RC7
- 3191435RC7
- 3201535RC7
- 3201640RC7

How to order (for example) 3-16-15-30-R C7:

No. of blades	Diameter	Pitch	Ø Shaft	Rotation
3	16"	15"	30	R



## Radice Propellers

### 4-Blade manganese bronze boat propellers type B-7

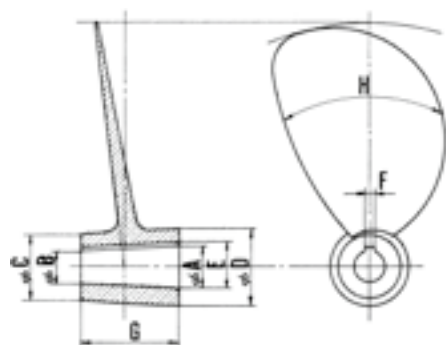

A	B	D	E	C	G	F
20	15.8	35	22.7	30	42	6
22	17.0	39	24.7	37	50	6
25	19.2	42	27.7	37	58	6
28	21.2	45	31.2	40	68	8
30	22.4	52	33.2	45	76	8
32	24.4	52	35.7	45	76	10
35	26.4	57	38.7	50	86	10
40	30.4	64	43.7	55	96	12
45	34.4	75	49.2	65	106	14
50	38.5	84	54.2	75	115	14
55	42.0	94	60.2	80	130	16
60	46.0	105	65.3	90	140	18
65	49.5	120	70.3	100	155	18
70	54.5	120	76.3	100	155	20

Ø mm	Ø inches
305	12
330	13
355	14
380	15
405	16
430	17
455	18
480	19
505	20
535	21
560	22
585	23
610	24
635	25
660	26
685	27
710	28
735	29
760	30

#### How to order (for example) 4-18-14-35-R B7:

No. of blades	Diameter	Pitch	Ø Shaft	Rotation
4	18"	14"	35	R

4-Blade Model B-7			
Fa/F 0,68			
P/D Max 0,9			
Diameter:			
Ø mm	Ø Inch	Pitch	Max. Ø Shaft
405	16	13 tot 15"	40mm
430	17	13 tot 18"	40mm
455	18	13 tot 18"	40mm
480	19	15 tot 19"	50mm
505	20	15 tot 20"	50mm
535	21	16 tot 20"	50mm
560	22	16 tot 20"	50mm
585	23	18 tot 20"	50mm
610	24	18 tot 20"	50mm
Boat Type		Displacement Vessel	
Speed		8/16Kn	

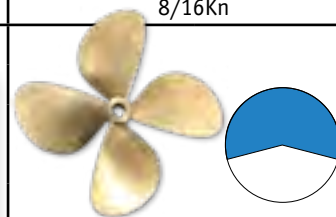

**Available in diameters  
from 16" up to 24"**

Please contact allpa for actual availability.  
Standard Stock Propellers are:

#### Item Code

4161330RB7  
4161530RB7  
4171430RB7  
4171435RB7  
4181435RB7  
4181635RB7  
4181840RB7  
4201840RB7  
4202040RB7

Radice Propellers

4-Blade manganese bronze boat propellers type S-8

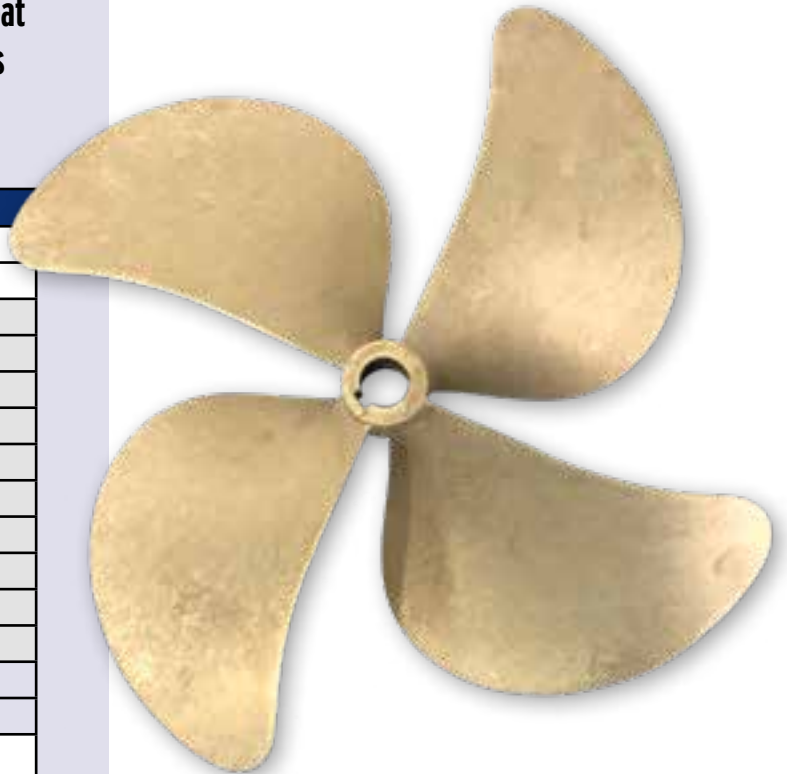

4-Blade Model S-8

Diameter:		P/D Max 1,3	
Ø mm	Ø Inch	Pitch	Max. Ø Shaft
405	16	-	-
430	17	15 tot 24"	40mm
455	18	16 tot 27"	40mm
480	19	16 tot 27"	40mm
505	20	16 tot 27"	40mm
535	21	18 tot 30"	50mm
560	22	18 tot 30"	50mm
585	23	20 tot 32"	50mm
610	24	20 tot 32"	50mm
Boat Type		Semi Planing / Planing Vessel	
Speed		17/30Kn	

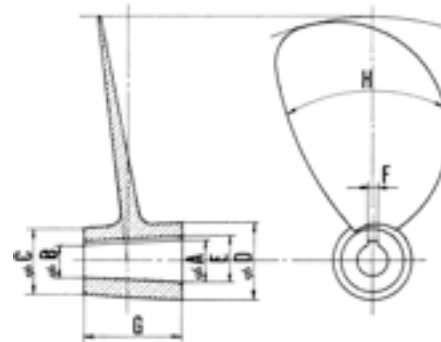
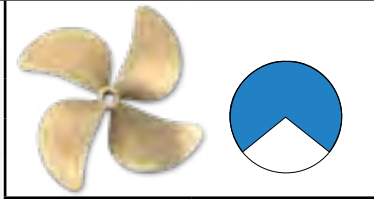

Ø mm	Ø inches
305	12
330	13
355	14
380	15
405	16
430	17
455	18
480	19
505	20
535	21
560	22
585	23
610	24
635	25
660	26
685	27
710	28
735	29
760	30

A	B	D	E	C	G	F
20	15.8	35	22.7	30	42	6
22	17.0	39	24.7	37	50	6
25	19.2	42	27.7	37	58	6
28	21.2	45	31.2	40	68	8
30	22.4	52	33.2	45	76	8
32	24.4	52	35.7	45	76	10
35	26.4	57	38.7	50	86	10
40	30.4	64	43.7	55	96	12
45	34.4	75	49.2	65	106	14
50	38.5	84	54.2	75	115	14
55	42.0	94	60.2	80	130	16
60	46.0	105	65.3	90	140	18
65	49.5	120	70.3	100	155	18
70	54.5	120	76.3	100	155	20

Available in diameters from 17" up to 24".

Please contact allpa for actual availability. Standard Stock Propellers are:

Item Code

- 416143ORS8
- 416163ORS8
- 416183ORS8
- 417163ORS8
- 4171835RS8
- 4181735RS8
- 4181835RS8
- 4191835RS8
- 419194ORS8
- 420204ORS8
- 421224ORS8

How to order (for example) 4-17-18-35-R S8:

No. of blades	Diameter	Pitch	Ø Shaft	Rotation
4	17"	18"	35	R

For Saildrive Volvo/Yanmar/Technodrive/Nanni  
Available in diameters from 14" up to 19"  
Standard-Stock-Propellers are:

**Radice 2-Blade  
Left Handed  
Aluminum  
Propellers**

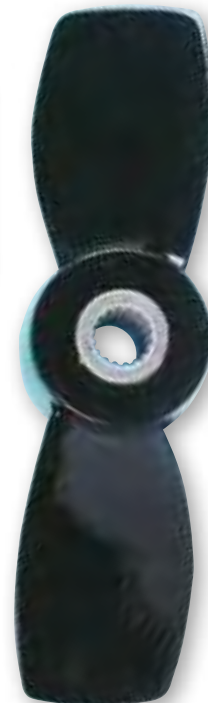

Item Code	Item Code	Item Code	Item Code	Item Code
21408SDL-AL	<b>21509SDL-AL</b>	21609SDL-AL	<b>21712SDL-AL</b>	21810SDL-AL
<b>21409SDL-AL</b>	21510SDL-AL	<b>21611SDL-AL</b>	21713SDL-AL	21811SDL-AL
21410SDL-AL	<b>21511SDL-AL</b>	21612SDL-AL	<b>21714SDL-AL</b>	21813SDL-AL
<b>21411SDL-AL</b>	21513SDL-AL	<b>21613SDL-AL</b>	21814SDL-AL	

**How to order: 2-14-09-SD-L-AL**

<b>2</b>	<b>14"</b>	<b>09"</b>	<b>SD</b>	<b>L</b>	<b>AL</b>
No of blades	Diameter	Pitch	Saildrive	Rotation	Aluminum

For Saildrive Volvo/Yanmar/ Technodrive/Nanni  
Available in diameters from 13" up to 18"

Standard-Stock-Propellers are:

**Radice 3-Blade  
Left Handed  
Aluminum  
Propellers**



Item Code	Item Code	Item Code	Item Code
31309SDL-AL	31412SDL-AL	31610SDL-AL	31712SDL-AL
31409SDL-AL	31511SDL-AL	31611SDL-AL	31713SDL-AL
31410SDL-AL	31512SDL-AL	31612SDL-AL	31715SDL-AL
31411SDL-AL	31513SDL-AL	31613SDL-AL	31716SDL-AL
			31816SDL-AL

**How to order: 3-16-10-SD-L-AL**

<b>3</b>	<b>16"</b>	<b>10"</b>	<b>SD</b>	<b>L</b>	<b>AL</b>
No of blades	Diameter	Pitch	Saildrive	Rotation	Aluminum

Available in 14" diameter

Standard-Stock-Propellers are:

Item Code
31409SDR-AL
31410SDR-AL
31411SDR-AL

**Radice 3-Blade  
Right Handed  
Aluminum  
Propellers with  
special Hub  
for Selva**



**How to order: 3-14-09-SD-R-AL**

<b>3</b>	<b>14"</b>	<b>09"</b>	<b>SD</b>	<b>R</b>	<b>AL</b>
No of blades	Diameter	Pitch	Saildrive	Rotation	Aluminum

**2 and 3 Blade  
SAILDRIVE  
folding propeller**



For propeller calculation and request for a quotation please contact us at [info@allpa.nl](mailto:info@allpa.nl)

2 and 3 Blade folding propeller for saildrive and shaft propellers. The Flexofold folding propellers are compatible with all standard Yanmar, Volvo Penta, Lombardini, Technodrive and Torqeedo Deep Blue engines. For use with a Selva saildrive, an additional adapter must be installed. The saildrive folding propellers are both suitable for left and right turn and available from 13" to 20".

**Models:**

- 2-blade composite folding propeller
- 2-blade folding propeller
- 2-blade folding propeller LA  
- LA = large anode
- 3-blade folding propeller



**2, 3 and 4 blade  
folding propeller  
for  
shaft propellers**



The folding propellers for shaft propellers are available from 13" to 27". The saildrive folding propellers are both suitable for left and right rotation for shaft from Ø25 to 45 mm.

**Models:**

- 2-blade folding propeller
- 3-blade folding propeller
- 4-blade folding propeller



**Replacement parts**



Code	Flex-O-Fold Parts
070165	Shock absorber 3-blade prop (per piece) <b>A</b>
070167	Locking screw pivot pin M8x30 (per piece) <b>C</b>
070168	Pivot pin Ø18mm for Ø130mm hub (per piece)
070169	Pivot pin Ø18mm for Ø120mm hub (per piece)
070170	Anode zinc 3-blade propeller <b>D</b>
070171	Anode aluminum 3-blade propeller
070173	Pivot pin Ø14mm 2-blade propeller <b>F</b>
070174	Pivot pin Ø16mm 3-blade propeller <b>G</b>
070175	Anode zinc 2-blade propeller (set of 2) <b>E</b>
070176	Anode kit magnesium/alum. 2-blade (set of 2)
070172	Shaft nut Saildrive M16x2
070179	Shaft nut Saildrive M20x2

**Radice 2-Bladed manganese bronze folding propellers**

Available in diameters from 12" up to 20"  
Standard-Stock-Folding-Propellers are:

Item Code	Item Code	Item Code	Item Code
K110825R	K130925R	K150925R	K171330R
K120825R	K131025R	K151125R	K171430R
-	K131125R	-	K171530R
-	K140925R	K161225R	K181330R
K130725R	K141025R	K171230R	K181430R
K130825R	K141125R	K171325R	K181530R

**2-Bladed folding propellers for shaft**

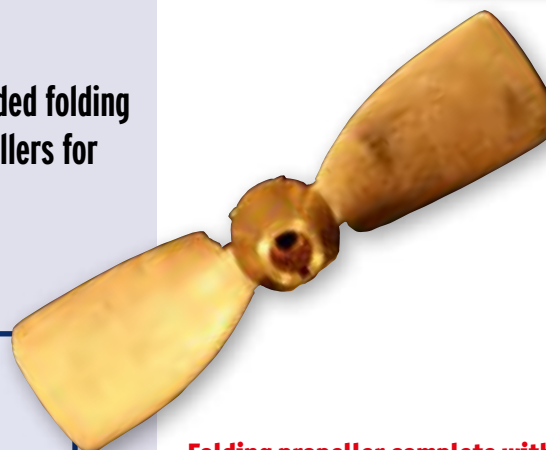

**Folding propeller complete with hub!**

**How to order: K-14-09-25-R**

<b>K</b>	<b>14"</b>	<b>09"</b>	<b>25</b>	<b>R</b>
2 blade folding	Diameter	Pitch	Øshaft	Rotation

**The sense of rotation for these propellers is: LEFT  
Radice 2-Bladed manganese bronze folding**

Available in diameters from 12" to 20".  
Standard-Stock-Folding-Propellers are:

Item Code	Item Code	Item Code	Item Code
K1308SDL	K1511SDL	K1610SDL	K1711SDL
K1408SDL	K1512SDL	K1611SDL	K1712SDL
K1409SDL	K1513SDL	K1612SDL	K1713SDL
K1509SDL	K1311SDL	K1613SDL	
K1510SDL	K1609SDL	K1710SDL	

**2-Bladed folding propellers for Sail Drive  
Volvo/Yanmar/  
Technodrive/  
Nanni**



**Folding propeller complete with hub!**

**How to order: K-14-09-SD-L**

<b>K</b>	<b>14"</b>	<b>09"</b>	<b>SD</b>	<b>L</b>
2 blade folding	Diameter	Pitch	Øshaft	Rotation

**The sense of rotation for these propellers is: RIGHT.  
Radice 2-Bladed manganese bronze folding propellers**

Available in diameters from 14" tot 16".  
Standard-Stock-Folding-Propellers are:

Item Code	Item Code	Item Code
K1308SDR	K1410SDR	K1610SDR
K1309SDR	K1411SDR	K1611SDR
K1408SDR	K1509SDR	K1613SDR
K1409SDR	K1510SDR	

**2-Bladed folding propellers for Sail Drive Selva**

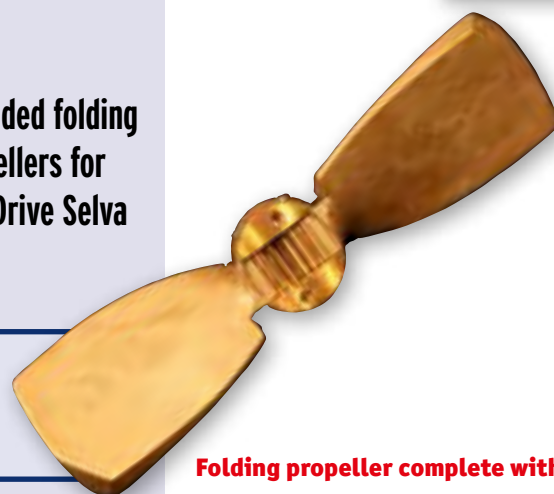

**Folding propeller complete with hub!**

**How to order: K-14-09-SD-R**

<b>K</b>	<b>14"</b>	<b>09"</b>	<b>SD</b>	<b>R</b>
2 blade folding	Diameter	Pitch	Øshaft	Rotation



incl. cap nut

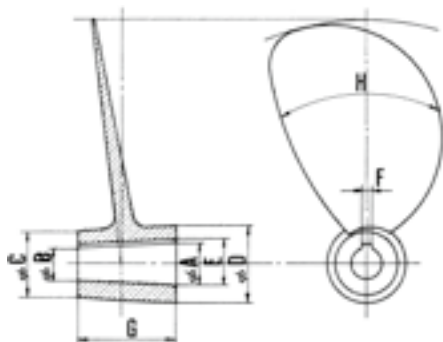

A	B	D	E	C	G	F
20	15.8	35	22.7	30	42	6
22	17.0	39	24.7	37	50	6
25	19.2	42	27.7	37	58	6
28	21.2	45	31.2	40	68	8
30	22.4	52	33.2	45	76	8
32	24.4	52	35.7	45	76	10
35	26.4	57	38.7	50	86	10
40	30.4	64	43.7	55	96	12
45	34.4	75	49.2	65	106	14
50	38.5	84	54.2	75	115	14
55	42.0	94	60.2	80	130	16
60	46.0	105	65.3	90	140	18
65	49.5	120	70.3	100	155	18
70	54.5	120	76.3	100	155	20

**Standard taper 1:10** All Propeller Shafts are completely machined and come with propeller nut with zinc anode, key and lock washer.

Item Code	Ø Shaft	Length
420100	20mm	1000mm
420150	20mm	1500mm
420200	20mm	2000mm
420250	20mm	2500mm
425100	25mm	1200mm
425150	25mm	1600mm
425200	25mm	2000mm
425250	25mm	2400mm
425300	25mm	3000mm
425350	25mm	3500mm
430100	30mm	1200mm
430150	30mm	1600mm
430200	30mm	2000mm
430250	30mm	2400mm
430300	30mm	3000mm
430350	30mm	3500mm
435100	35mm	1200mm
435150	35mm	1600mm
435200	35mm	2000mm
435250	35mm	2400mm
435300	35mm	3000mm
435350	35mm	3500mm
435400	35mm	4000mm
440150	40mm	1600mm
440200	40mm	2000mm
440250	40mm	2400mm
440300	40mm	3000mm
440350	40mm	3500mm
440400	40mm	4000mm

Item Code	Ø Shaft	Length
445150	45mm	1600mm
445200	45mm	2000mm
445250	45mm	2400mm
445300	45mm	3000mm
445350	45mm	3500mm
445400	45mm	4000mm
450150	50mm	1500mm
450200	50mm	2000mm
450250	50mm	2500mm
450300	50mm	3000mm
450350	50mm	3500mm
450400	50mm	4000mm
455150	55mm	1500mm
455200	55mm	2000mm
455250	55mm	2500mm
455300	55mm	3000mm
455350	55mm	3500mm
455400	55mm	4000mm
460150	60mm	1500mm
460200	60mm	2000mm
460250	60mm	2500mm
460300	60mm	3000mm
460350	60mm	3500mm
460400	60mm	4000mm

### Propeller Shafts Stainless Steel AISI 329

#### Key Sizes (wxhxl in mm):

Shaft 20mm:	6x6x30	<b>Item Code 31100100</b>
Shaft 25mm:	6x6x40	<b>Item Code 31100700</b>
Shaft 30mm:	8x7x55	<b>Item Code 31100800</b>
Shaft 35mm:	10x8x70	<b>Item Code 31100900</b>
Shaft 40mm:	12x8x82	<b>Item Code 31101000</b>
Shaft 45mm:	14x9x88	<b>Item Code 31101100</b>
Shaft 50mm:	14x9x88	<b>Item Code 31101100</b>
Shaft 55mm:	16x10x100	<b>Item Code 31101400</b>
Shaft 60mm:	18x11x118	<b>Item Code 31101600</b>

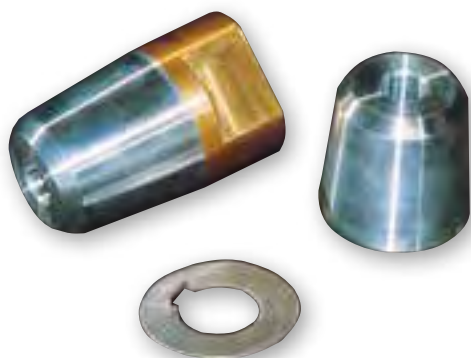

### allpa® Propeller Nuts with Zinc Anode

Complete nut Item Code	Shaft (mm)	Thread	Zink only Item Code	Lock Washer Item Code
465020	20	M12 x 1,5	465120	465220
465025	25	M16 x 1,5	465125	465225
465030	30	M20 x 1,5	465130	465230
465035	35/40	M24 x 2	465135	465235
465040	40	M27 x 2	465140	465240
465045	45	M33 x 2	465145	465245
465045/30	45	M30 x 2	465145	465245/30
465050	50	M36 x 3	465150	465250
465055	55	M40 x 3	465155	465255
465060	60	M45 x 3	465160	465260

For aluminum anode,  
see p. 136

### Rope Cutters for Propeller Shafts and Saildrives

Cuts nylon ropes, fishing nets, Kevlar® and thin steel cables (max.7mm). Made of high grade stainless steel AISI-316L. Sharp as a razor!  
Very easy installation.

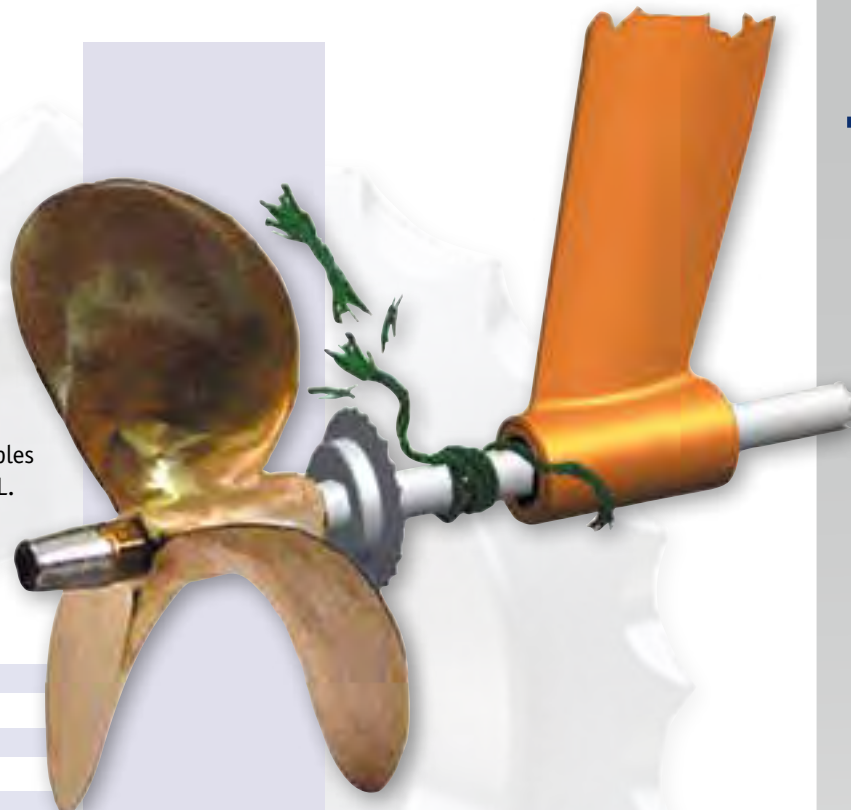

#### Rope Cutters for Propeller Shafts:

Item Code	Ø Shaft	Diam.	Width
22.40022022	22mm	80mm	17mm
22.40025022	25mm	80mm	17mm
22.40030022	30mm	80mm	17mm
22.40035022	35mm	100mm	17mm
22.40040022	40mm	100mm	17mm
22.40045022	45mm	120mm	17mm
22.40050022	50mm	120mm	17mm
22.40060022	60mm	150mm	30mm

## Rope Cutters

### Rope Cutters for Saildrives:

Easy installation. Due to the size, the original anode must be replaced by an adapted anode to make space for the rope cutter. This special anode (not shown) comes in a set together with the cutter. (not for Volvo 130S: no special anode required). Three holes should be machined threaded on the propeller hub. Use the cutter as a template. An installation manual is included.

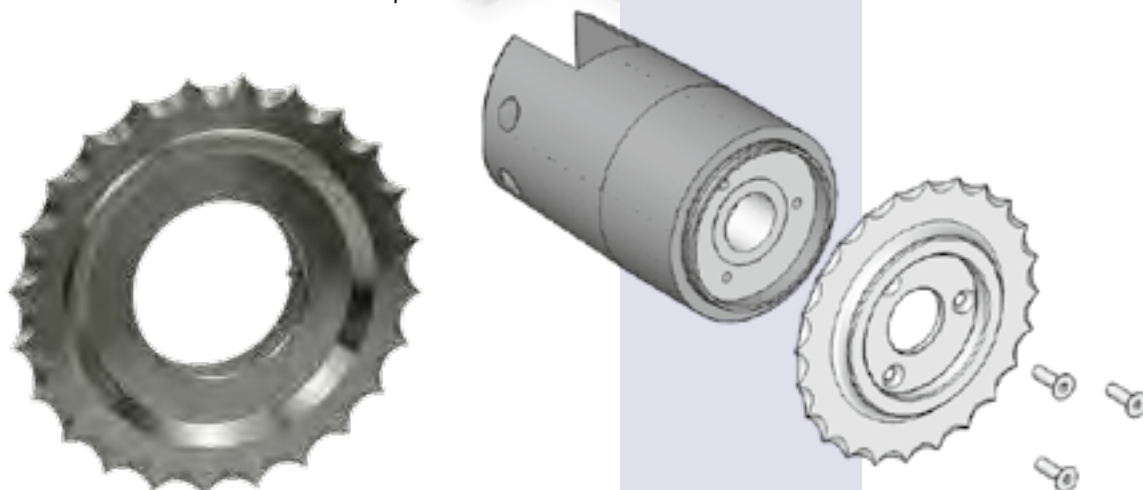

Saildrive	Set Item Code	Cutter Item Code	Anode Item Code
Yanmar SD20/SD31 <sup>(1)</sup>	22.40039023	-	22.400390921
Volvo 120S	22.40039022	-	22.400390922
Volvo 130S <sup>(2)</sup>	-	22.400390251	-
SPROP-60 (Technodrive)	22.40039024	-	22.2481350084

(1): Not suitable for Flex-0-Fold

(2): Not suitable for folding propellers, fixed propellers only

## Turbine Filters



### Racor Turbine Filters

Item Code	Model	Cap. L/H	Dims. (HxW)	Connection	Service Elements
079021	500FG30	227	292 x 147	M16 x 1-1/2	2010PM-OR
079022	902FH30	341	432 x 152	M22 x 1-1/2	2040PM-OR
079023	1002FH30	681	559 x 152	M22 x 1-1/2	2020PM-OR

Item Code 079RK30476



### Racor Marine Turbine Filters CE-approved (ISO 11088 & 10088)

Item Code	Model	Cap. L/H	Dims. (HxW)	Connection	Service Elements
079020	500MAM30	227	292 x 197	M16 x 1-1/2	2010PM-OR
079024	902MAM30	341	432 x 152	M22 x 1-1/2	2040PM-OR
079026	1002MAM30	681	559 x 152	M22 x 1-1/2	2020PM-OR



### Racor Double Turbine Filters

Item Code	Model	Cap. L/H	Dims. (HxW)	Connection	Service Elements
079081	75 500FGX30	454	292 x 368	3/4" - 16 UNF	2010PM-OR
079082	75 1000FGX30	1363	559 x 476	7/8" - 14 UNF	2020PM-OR



### Racor Double Marine Turbine Filters CE-approved (ISO 11088 & 10088)

Item Code	Model	Cap. L/H	Dims. (HxW)	Connection	Service Elements
079081/M	75 500MAXM30	454	292 x 368	3/4" - 16 SAE	2010PM-OR
079082/M	75 1000MAXM30	1363	559 x 476	7/8" - 14 SAE	2020PM-OR

Fuel flow: HP x 0,68 = l/hour



## Spin on Filters

### Spin On Filters - 100 Serie CE-approved (ISO 11088 & 10088)

Item Code	Model	Cap. L/H	Dims. (HxW)	Connection	Service Elements
079005	110A	57	152 x 81	M14 x 1-1/2	R11T

### Spin On Marine Filters - 100 Serie CE-approved (ISO 11088)

Item Code	Model	Cap. L/H	Dims. (HxW)	Connection	Service Elements
079004	120R-RAC-02	57	211 x 102	1/4" - 18NPTF	S3240

### Spin On Filters - 200 Serie

Item Code	Model	Cap. L/H	Dims. (HxW)	Connection	Service Elements
079001	215R30	57	211 x 102	M14 x 1-1/2	R15P
079002	230R30	114	229 x 102	M14 x 1-1/2	R20P
079003	245R30	170	267 x 102	M14 x 1-1/2	R25P

### Spin On Filters - 600 Serie

Item Code	Model	Cap. L/H	Dims. (HxW)	Connection	Service Elements
079011	690R30MTC	340	284 x 114	M16 x 1-1/2	R90P

### Double Spin On Filters

Item Code	Model	Cap. L/H	Dims. (HxW)	Connection	Service Elements
079085	75/B3209	454	278 x 206	M18 x 1-1/2	S3209P



Tules for Racor

Item Code	Hose Connection	Connection
079210	Hose pillar straight 6mm	M14 x 1-1/2
079211	Hose pillar straight 8mm	M14 x 1-1/2
079212	Hose pillar straight 10mm	M14 x 1-1/2
079201	Banjo bolt M14	M14 x 1-1/2
079208	Banjo hose 6mm	M14
079209	Banjo hose 10mm	M14
079216	Brass ring M14 /st	M14

079218	Hose pillar straight 8mm	M16 x 1-1/2
079217	Hose pillar angled 8mm	M16 x 1-1/2
079238	Hose pillar straight 10mm	M16 x 1-1/2
079237	Hose pillar angled 10mm	M16 x 3/8"
079207	Banjo bolt M16	M16 x 1-1/2
079214	Banjo hose 12mm	M16
079215	Brass ring M16 /st	M16
079225	Brass fitting 10mm	M16 x 1-1/2
079220	Reducer M16 -> M14	M16 x 1-1/2

079203	Banjo bolt M18	M18 x 1-1/2
079204	Banjo hose 10mm	M18
079230	Banjo hose 12mm	M18
079228	Banjo hose 16mm	M18
079205	Brass ring M18 /st	M18
079221	Reducer M18 -> M16	M18 x 1-1/2
079233	Reducer M22 -> M18	M22 x 1-1/2
079222	Reducer M22 -> M16	M22 x 1-1/2
079223	Tule Straight 19mm	M22 x 1-1/2



For Hose Clamps see page 599

**Water In Fuel Detection Kit**  
Art. RK30880E

Suitable for all Racor filters.

Components:

- Racor Water in Fuel sensor
- Control lamp with mounting flange
- Cable with sealed connectors

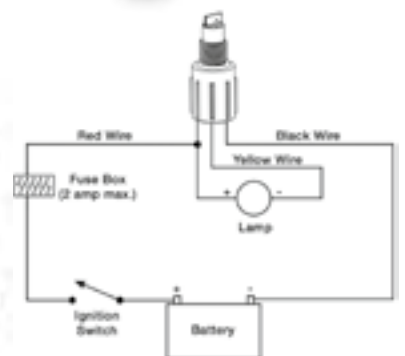

## Racor Spin On Filters Replacement Elements

Service Elements	30 micron P	10 micron T	2 micron S	Model
	Item code	Item code	Item code	
R11		079093		110A
R15	079051	079038	079039	215R
R20	079052	079048	079049	230R
R24	079041	079042	079040	220R
R25	079053	079055	079044	245
R26	079046	079047	079045	225R
R45	079056	079062	079058	445R 645R
R60	079063	079059	079057	460R 660R
R90	079060	079061		490R 690R
R120	079054	079064		4120R
S3209	079088	079126		079085
S3209P	079087 ->	incl. transparent bowl		079085
S3232		079090		660R
S3227		079095		490R
S3240		079065		660RAC



## Racor (Marine) Turbine Filters Replacement Elements

Service Elements	30 micron P	10 micron T	2 micron S	Model
	Item code	Item code	Item code	
2010 P/T/S M-OR	079071	079076	079077	500 Turbine
2020 P/T/S M-OR	079073	079069	079068	1000 Turbine
2040 P/T/S M-OR	079072	079078	079079	900 Turbine





### Sierra Gasoline Replacement-filters

**Item Code 64187789** 21 micron filter. Replaces:  
OMC 502906 Volvo 3852413,  
3851218-2

**Item Code 64187846** 21 micron filter. Replaces:  
OMC 502905

**Item Code 64187944** 10 micron filter. Replaces:  
Mercury 35807172, 802893Q

**Item Code 64187946** 10 micron filter. Replaces:  
OMC 502905

**Item Code 64187947** 10 micron filter. Replaces:  
Suzuki 99105-20006,  
Honda 17670-ZW1-030GH

**Item Code 64187955** 10 micron filter. Replaces:  
Yamaha 68F-24563-10-00

Gasoline Filters



### Fuel-In line-filters

**Universal filters**  
for hose Ø6-8mm

**For gasoline engines:**

**Item Code 000026** up to 2.000cc, straight

**Item Code 000028** up to 2.000cc, elbow

**Item Code 000030** up to 3.500cc, straight

**For diesel engines:**

**Item Code 000027** up to 2.000cc, straight

**Item Code 000029** up to 2.000cc, elbow

**Item Code 000031** up to 3.500cc, straight

**Item Code 000033** up to 3.500cc, straight

Diesel Filters



**DOUBLE Fuel (Diesel) Filters with Settling Bowl:**

1x Transparent and 1x aluminum bowl, bleeding screw and interchangeable cartridges. For engines max 3.500cc.

Max. allowed flow 50l/h. Excluding hose fittings.

Item Code 486400

2x Aluminum bowl, bleeding screw and

interchangeable cartridges. For engines max 3.500cc.

Max. allowed flow 50l/h. Excluding hose fittings.

Item Code 486401 ISO 7840:2004, ISO 10088:2009

**SINGLE Fuel (Diesel) Filters with Settling Bowl:**

1x Transparent bowl, bleeding screw and interchangeable cartridge. For engines max 3.500cc.

Max. allowed flow 50l/h. Excluding hose fittings.

Item Code 486410

1x Aluminum bowl, bleeding screw and

interchangeable cartridge. For engines max 3.500cc.

Max. allowed flow 50l/h. Excluding hose fittings.

Item Code 486420 ISO 7840:2004, ISO 10088:2009

Spare cartridge element for filters 486400, 486401, 486410 and 486420. For engines max 3.500cc. Max. allowed flow 50l/h.

Item Code 486470

**Fuel Filters (Diesel) with Water Separator**



Kit of 2 swiveling fittings + 2 hose connection Ø8mm + 4 seal rings

Item Code 486491

Kit of 2 swiveling fittings + 2 hose connection Ø10mm + 4 seal rings

Item Code 486492

Kit of 2 straight hose fittings Ø8mm + 4 seal rings

Item Code 486493

Kit of 2 straight hose fittings Ø10mm + 4 seal rings

Item Code 486494



**Fuel-Water Separator-Kit**

Item Code 6418-78521 Filter (21 micron) with aluminum bracket and 2x blind plug, without hose nipples

Item Code 6418-7845 Filter element 21 micron

Item Code 6418-7945 Filter element 10 micron

**Fuel-Water Separator-Kit with aluminum bowl**

Item Code 6418-7951 Filter (10 micron) with aluminum bracket, aluminum bowl and 2x blind plug, without hose nipple

Item Code 6418-7919 Filter element 10 micron

Item Code 6418-7924 Spare aluminum bowl

**Hose nipples**

Item Code 6418-8042 Straight Hose nipple 1/4" NPT x 1/4" (Ø6mm)

Item Code 6418-8055 Straight Hose nipple 1/4" NPT x 5/16" (Ø8mm)

Item Code 064302 90° Hose nipple 1/4" x 3/8" hose (Ø10mm)

Item Code 6418-4264 Blind plug 1/4" NPT

**Features:**

- Steel end caps on element. Heavy duty spring
- Powder coated outside, epoxy coated inside for corrosion protection
- Aluminium bracket with 1/4" NPT inlet/outlet.
- Meets OEM specifications.
- Will not separate 2 cycle oil from gasoline!
- Best flow rate of all major brands (max. 125 g.p.h./470 l/h)
- Removes 98,8% of emulsified water.
- Do not use with diesel

\*Not recommended for 1992 Gen II 4.3L/4.3LX Mercruiser with electric fuel pump and in-line fuel filter (OEM#35-805031T)

**Sierra Fuel-Water Separator**



Also see page 113/114

Recommended for all 2- & 4-cycle gasoline engines\*





### Fuel Foam-Stop

**Item Code 486590**

This foam-stop which is directly connected to the deck entry, avoids that foam and fuel come out during the filling of the tank, coming back into the body of the foamstop which transforms the foam in liquid and send to the tank. Provided with 2 rubber adaptors complete with clamp to connect to the deck entry with diam. 38mm or 50mm. Connection with the tank by hose connection with diam. 38mm or 50mm.

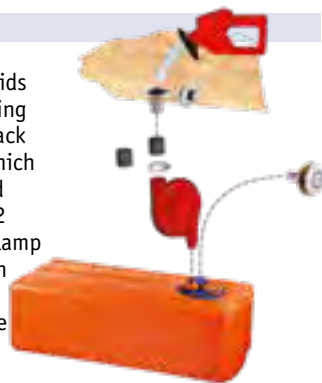

### Diesel & Petrol Resistant Rubber Hose with Steel Spiral Inlay

Suitable for diesel, bio-diesel and unleaded fuel.

- Standards: • SAE J 1527 • USCG A1 R2  
 • ISO 7840 A1 CE
- Approved: • CE • CE 0474 RINA • LLOYD'S REGISTER

- Colour: black with red label with Print
- Temp. range: -30°C to + 100°C

- Item Code 852532** 25 x 32mm – max 10 bar  
**Item Code 853245** 32 x 44mm – max 10 bar, with steel spiral inlay  
**Item Code 853852** 38 x 51mm – max 10 bar, with steel spiral inlay  
**Item Code 855065** 51 x 64mm – max 10 bar, with steel spiral inlay



### Diesel & Petrol Resistant Rubber Hose

Suitable for diesel, bio-diesel and unleaded fuel.

- Standards: • SAE J 1527 • USCG A1 R1  
 • ISO 7840 A1 CE
- Approved: • CE • CE 0474 RINA  
 • LLOYD'S REGISTER

- Colour: Black with print
- Temperature range: -30°C + 100°C

- Item Code 002012** 6 x 16mm – max 14 bar  
**Item Code 002013** 8 x 17mm – max 14 bar  
**Item Code 002060** 10 x 19mm – max 14 bar  
**Item Code 002062** 12.5 x 22mm – max 12 bar  
**Item Code 002014** 16 x 26mm – max 10 bar

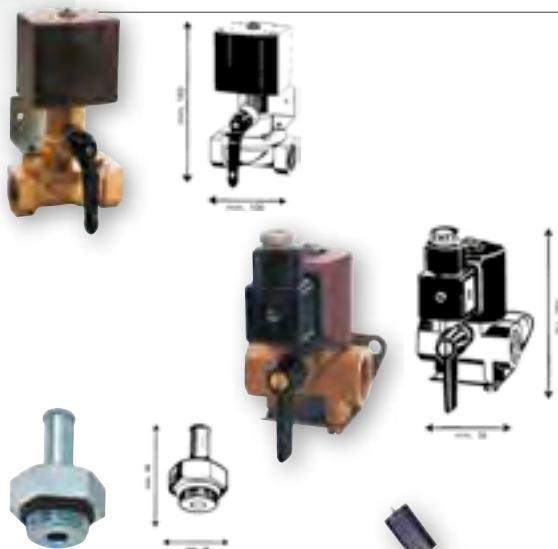

### Electric Fuel Line Valves

- Item Code 310020** 12V/12W 1/2" inner thread  
**Item Code 310021** 24V/12W 1/2" inner thread  
 Inner flow Ø7mm. Flow capacity 80/100l/h. Made of bronze and stainless steel. With By-Pass function.  
**Item Code 310022** 12V/60W 1" inner thread  
**Item Code 310023** 24V/60W 1" inner thread.  
 Inner flow Ø25mm. Made of bronze and stainless steel. With By-Pass function.  
**Item Code 310090** Nipple 1/2" x Ø10mm hose  
**Item Code 310091** Nipple 1/2" x Ø8mm copper  
**Item Code 310092** Nipple 1/2" x Ø10mm copper  
**Item Code 310093** Nipple 1/2" x Ø12mm copper

These valves are normally closed  
 Current on: open  
 Current off: closed

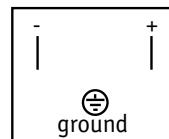

### Fuel Tank Sender with Gauge

**CODE F**  
 Fuel Gauge Sender (240-33 Ohm). 5-Hole standard mounting pattern, arm right or left adjustable. Suitable for tanks with 4-24" (10-61cm) depth. New „VITON" flange seal: suitable for all fuel types, worldwide.

- Item Code 90424K** Fuel Gauge Sender  
**Item Code 57902E** Fuel Gauge

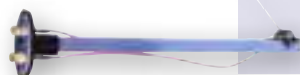

Stainless Steel Fuel Tanks with Flange & Connectors (except vertical 21, 32 & 50L Tanks), with Return- and Ventilation Connection. Complete with 1/4" Drain Plug.  
 All Tanks have a blind cover for tank gauge sender (Teleflex/VDO mounting pattern) except 21L Tank.  
 Material Thickness up Thru 90L Tank: 1mm.  
 Material Thickness 120L Tank: 1,2mm.  
 Tank of 50L and up are provided with baffles.  
 Calculation of Tank Capacity is based on the Rectangular sizes without reckoning the radius!

<b>Item Code 020001</b>	21l	horizontal	Dim. 30x35x20cm (lxbxh)
<b>Item Code 020002</b>	21l	vertical	Dim. 30x20x35cm (lxbxh)
<b>Item Code 035001</b>	32l	horizontal	Dim. 60x35x17cm (lxbxh)
<b>Item Code 035002</b>	32l	vertical	Dim. 60x17x35cm (lxbxh)
<b>Item Code 050001</b>	50l	horizontal	Dim. 70x35x20cm (lxbxh)
<b>Item Code 050002</b>	50l	vertical	Dim. 70x20x35cm (lxbxh)
<b>Item Code 070000</b>	70l	horizontal	Dim. 70x35x28cm (lxbxh)
<b>Item Code 090000</b>	90l	horizontal	Dim. 90x35x28cm (lxbxh)
<b>Item Code 120000</b>	120l	horizontal	Dim. 120x35x28cm (lxbxh)



Set of two stainless steel fixing braces for s/s fuel tanks

- Item Code 075035** For 32l tanks
- Item Code 075050** For 21 & 50l tanks
- Item Code 075070** For 70-90-120l tanks

### Stainless Steel Fuel Tanks with Flange & Connectors

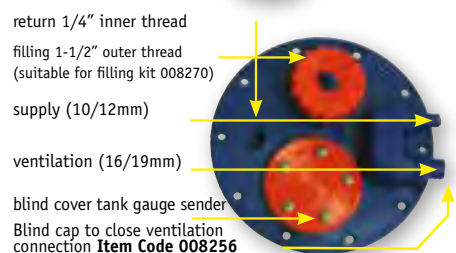

### Stainless Steel Tank Fixing



### Fuel tanks made of High Density Polythene.

Standard with pre-mounted flange & connectors

<b>Item Code 000042</b>	42l	500x350x300 (+20)mm (lxbxh)
<b>Item Code 000055</b>	55l	650x350x300 (+20)mm (lxbxh)
<b>Item Code 000070</b>	70l	800x350x300 (+20)mm (lxbxh)
<b>Item Code 008033</b>	33l	500x350x230 (+20)mm (lxbxh)
<b>Item Code 008043</b>	43l	650x350x230 (+20)mm (lxbxh)
<b>Item Code 008053</b>	53l	800x350x230 (+20)mm (lxbxh)
<b>Item Code 008080</b>	62l	660x300x410 (+25)mm (lxbxh)
<b>Item Code 008110</b>	91l	910x300x410 (+25)mm (lxbxh)
<b>Item Code 008102</b>	102l	800x400x400 (+25)mm (lxbxh)
<b>Item Code 008120</b>	120l	950x400x400 (+25)mm (lxbxh)
<b>Item Code 008140</b>	140l	1100x400x400 (+25)mm (lxbxh)

### Plastic Inboard Fuel Tanks



- Item Code 008250** Flange with connectors.  
 Ø Flange: 175mm  
 Cut out size Ø120mm
- Item Code 482017** Spare hose connection (1/4" x 8mm)
- Item Code 1004A6** Spare hose connection (1/4" x 6mm)
- Item Code 008249** Spare O-ring for flange

**This flange is already mounted as standard on most rigid stainless steel and Polythene Fuel Tanks.**

### Fuel Tank Connector Flange

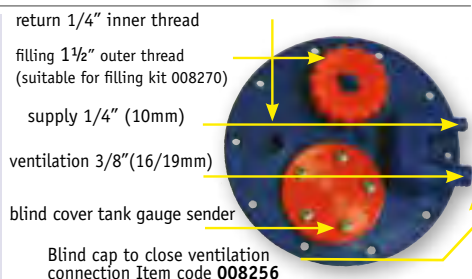

- Item Code 483602** Plastic odor filter with active carbon, for Fuel and Black Water Tanks.  
 With bracket. Hose connection Ø19-25mm  
 D=150mm, H=132mm  
 (204mm incl. hose pillars)  
**Item Code 483604** Replacement Filter Element

### Odor filter for Fuel & Black Water Tanks





**Stainless Steel A316 Deck Entries**

Deck fillers with color-coded international symbols with engraved lettering. Straight model with Ø38 mm hose connection. Build in depth is 90mm.

- Item Code 269030 Diesel with venting,** Ø38mm hose connection and engraved text in the stainless steel mounting rings
- Item Code 269031 Water with venting,** Ø38mm hose connection and engraved text in the stainless steel mounting rings



**Stainless Steel A316 Deck Entries**

Deck fillers with color-coded international symbols with engraved lettering and separate key. Straight and 30° angled models with Ø38mm hose connection. Depth is 76mm.

0° Models		30° Models	
ØFlange 76mm		ØFlange 90mm	
<b>Item Code 078221</b>	<b>Water</b>	<b>Item Code 078715</b>	<b>Water</b>
<b>Item Code 078218</b>	<b>Waste</b>	<b>Item Code 078716</b>	<b>Waste</b>
<b>Item Code 078219</b>	<b>Gas</b>	<b>Item Code 078717</b>	<b>Gas</b>
<b>Item Code 078222</b>	<b>Diesel</b>	<b>Item Code 078713</b>	<b>Diesel</b>
<b>Item Code 078220</b>	<b>Fuel</b>	<b>Item Code 078718</b>	<b>Fuel</b>
<b>Item Code 078223</b>	<b>Oil</b>	<b>Item Code 078714</b>	<b>Oil</b>
<b>Item Code 078224</b>	<b>Petrol</b>	<b>Item Code 078719</b>	<b>Petrol</b>
<b>Item Code 078225</b>	Spare key	HTH 30mm	
<b>Item Code 078227</b>	Spare Cap (1-1/4")		

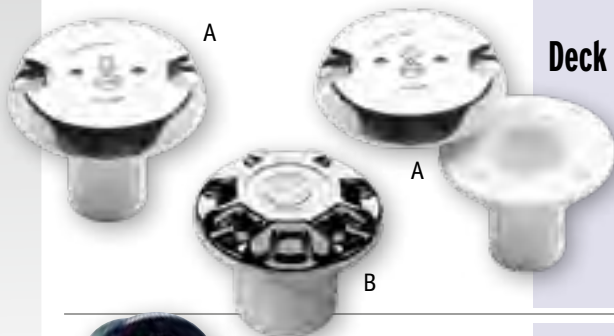

**Deck Entries**

Stainless Steel Housing out of plastic, the filler cap is Stainless Steel. (A)

- Item Code 482043 Fuel** Ø38mm
- Item Code 482044 Fuel** Ø50mm
- Item Code 482045 Water** Ø38mm

Plastic Housing out of plastic with chrome plated lid. (B)

- Item Code 482046 Fuel** Ø38mm
- Item Code 482047 Fuel** Ø50mm
- Item Code 482048 Water** Ø38mm



**Chromed Brass Deck Entries**

Deck Fillers with separate key Inner Thread 1-1/2". Flange Ø83mm. H=48mm, Cut-out size Ø54mm

- Item Code 001173 "Fuel"**
- Item Code 001175 "Aqua"**
- Item Code 001174** Single key HTH 25mm



**Chromed Brass Deck Entries**

Deck fillers with folding key Flange Ø89mm. H=81mm, Cut-out size Ø50mm

- Item Code 482040 "Diesel",** Ø50mm
- Item Code 482041 "Water",** Ø35mm
- Item Code 482042 "Fuel",** Ø50mm



**Nylon Deck Entries with Color-Coded keys**

4 Pcs different Color Keys are included: Red/Gas, Green/Diesel, Blue/Water, Black/Waste  
6 Pcs Name Plates are included: Diesel, Fuel, Gas, Petrol, Waste, Water

- Item Code N2940006** Ø38mm
- Item Code N2940007** Ø51mm



Hose clips with punched wedged thread and fixed housing. **Packed per 4 pieces**  
 Item Codes FA2631-FA2647

Item Code	Ømm	H(mm)	pack	Nm
FA2631	8- 12	12,7	4	3
FA2632	11- 20	12,7	4	3
FA2633	13- 23	12,7	4	3
FA2634	14- 27	12,7	4	3
FA2635	21- 38	12,7	4	3
FA2636	25- 40	12,7	4	3
FA2637	27- 51	12,7	4	4
FA2638	40- 64	12,7	4	4
FA2639	50- 70	12,7	4	4
FA2640	70- 90	12,7	4	4
FA2641	72- 95	12,7	4	4
FA2642	78-102	12,7	4	4
FA2644	98-114	12,7	4	4
FA2645	76-127	12,7	4	4
FA2646	117-140	12,7	4	4
FA2647	79-152	12,7	4	4

stainless steel  
316

For very strong clamping (10-45kg/cm<sup>2</sup>)  
 With bolt and bevelled edges. Re-usable

- Item Codes FA2602 - FA2630. **Supplied per piece**

Item Code	Ømm	H(mm)	L(mm)
FA2602	29- 31	20x0,8	6x 50
FA2603	32- 35	20x0,8	6x 50
FA2604	36- 39	20x0,8	6x 50
FA2605	40- 43	20x0,8	6x 50
FA2606	44- 47	22x1,2	7x 60
FA2607	48- 51	22x1,2	7x 60
FA2608	52- 55	22x1,2	7x 60
FA2609	56- 59	22x1,2	7x 60
FA2610	60- 63	22x1,2	7x 60
FA2611	64- 67	22x1,2	7x 60
FA2612	68- 73	24x1,5	8x 75
FA2613	74- 79	24x1,5	8x 75
FA2614	80- 85	24x1,5	8x 75
FA2615	86- 91	24x1,5	8x 75
FA2616	92- 97	24x1,5	8x 85
FA2617	98-103	24x1,5	8x 85
FA2618	104-112	24x1,5	8x 85
FA2619	113-121	24x1,5	8x 85
FA2620	122-130	24x1,5	8x 85
FA2621	131-139	26x1,7	10x 95
FA2622	140-148	26x1,7	10x 95
FA2623	149-161	26x1,7	10x 95
FA2624	162-174	26x1,7	10x105
FA2625	175-187	26x1,7	10x105
FA2626	188-200	26x1,7	10x105
FA2627	201-213	26x1,7	10x105
FA2628	214-226	26x1,7	10x105
FA2629	227-239	26x1,7	10x105
FA2630	240-252	26x1,7	10x105

### Stainless Steel Hose Clamps





**Stainless steel skin fitting for exhaust - 45°**

	A mm	B mm	C mm	D mm	E mm
Item Code 048540	40	60	60	13.5	70
Item Code 048550	50	75	75	16.5	86
Item Code 048563	63	90	90	20.0	104
Item Code 048576	76	110	110	25.0	130
Item Code 048590	90	110	110	30.0	156
Item Code 048602	102	115	115	35.0	175



**Stainless Steel A316 Exhaust Skin Fitting**

Mirror Polished Exhaust Fitting. Includes a durable anti-reflux stainless steel valve and a drip collar to prevent streaking of the hull.

	A mm	B mm	C mm	D mm	E mm
Item Code 078940	38	146	51,5	72	32+40
Item Code 078701	52	116	56	80	32
Item Code 078702	76	146	88	118	33



**Stainless Steel A316 Exhaust Skin Fitting**

Mirror Polished Exhaust Fitting. Invisible mounting studs. Includes anti reflux rubber flap.

	ØFlange	ØCut Out	ØHose (mm)
Item Code 024140	75	45	40
Item Code 024145	75	45	45
Item Code 024150	100	60	50
Item Code 024160	100	60	60
Item Code 024175	131	90	75
Item Code 024190	131	90	90



**Brass Skin Fittings**

Code 001123B15	3/8" x 15 mm	Code 001123G45	1 1/2" x 45 mm
Code 001123C18	1/2" x 18 mm	Code 001123J57	2" x 57 mm
Code 001123D24	3/4" x 24 mm	Code 001123K70	2 1/2" x 72 mm
Code 001123E30	1" x 30 mm	Code 001123L80	3" x 80 mm
Code 001123F40	1 1/4" x 40 mm		



**Exhaust Hose with Lloyd's Approval**

Very flexible Exhaust Hose with Steel Spiral. -25° - +120°C. Inlay Black, with green print: "DIESEL EXHAUST HOSE LLOYD'S register 96/00127 (E3) & 96/00126 (E3)"

Item Code 800040	40 x 50mm	Item Code 800075	76 x 86mm
800045	45 x 55mm	800090	90 x 100mm
800050	50 x 62mm	800100	102 x 113mm
800060	60 x 70mm	800127	127 x 137mm
		800152	152 x 164mm

## Stainless Steel Water Lock/ Mufflers

Item Code	Hose (mm)	Volume	In	Out	Dims. ( L x Ø)
05241542	40mm	4l	0°	0°	200 x 160mm
05241540	40mm	4l	0°	45°	200 x 160mm
05241547	45mm	4l	0°	0°	200 x 160mm
05241545	45mm	4l	0°	45°	200 x 160mm
05241548	51mm	4l	0°	0°	200 x 160mm
05261699	51mm	4l	0°	45°	200 x 160mm
05241549	51mm	6l	0°	0°	300 x 160mm
05261698	51mm	6l	0°	45°	300 x 160mm
05241555	57mm	6l	0°	0°	300 x 160mm
05241557	57mm	6l	0°	45°	300 x 160mm
05255473	63mm	6l	0°	0°	300 x 160mm
05241563	63mm	6l	0°	45°	300 x 160mm
05241550	76mm	6l	90°	45°	300 x 160mm
05241552	76mm	8l	0°	0°	400 x 160mm
05254547	76mm	8l	0°	45°	400 x 160mm
05241551	76mm	8l	90°	45°	400 x 160mm
05252928	89mm	12l	0°	0°	360 x 210mm
05252927	89mm	15l	0°	0°	450 x 210mm
05252930	89mm	15l	0°	45°	450 x 210mm
05262975	100mm	17l	0°	0°	500 x 215mm
05262977	100mm	17l	0°	45°	500 x 215mm
05262979	100mm	24l	0°	0°	500 x 245mm
05272977	127mm	30l	45°	90°	550 x 265mm

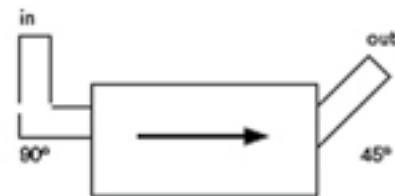
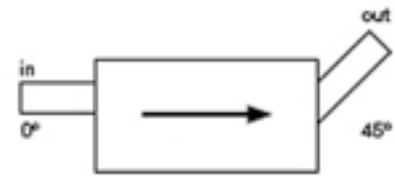
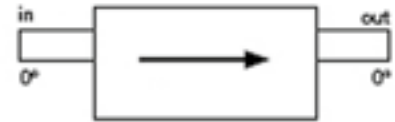

### Horizontal Water Lock, A304

Volume 4,6 l:

Item Code	Ø (mm)	W (mm)	ØHose (mm)
004400	160	230(+2 x 50)	40
004450	160	230(+2 x 50)	45
004500	160	230(+2 x 50)	50
004600	160	230(+2 x 50)	60

### Stainless Steel Water Locks Horizontal



### Upright Water Lock, A304

Volume 4,0 l:

Item Code	Ømm	H (mm)	ØHose(mm)
003400	160	200 (+50)	40
003450	160	200 (+50)	45
003500	160	200 (+50)	50
003600	160	200 (+50)	60

### Stainless Steel Water Locks Upright

003400-003600



Volume 21 l:

003601	300	300 (+ 2 x 50)	60
003750	300	300 (+ 2 x 50)	75
003900	300	300 (+ 2 x 50)	90

003601-003900



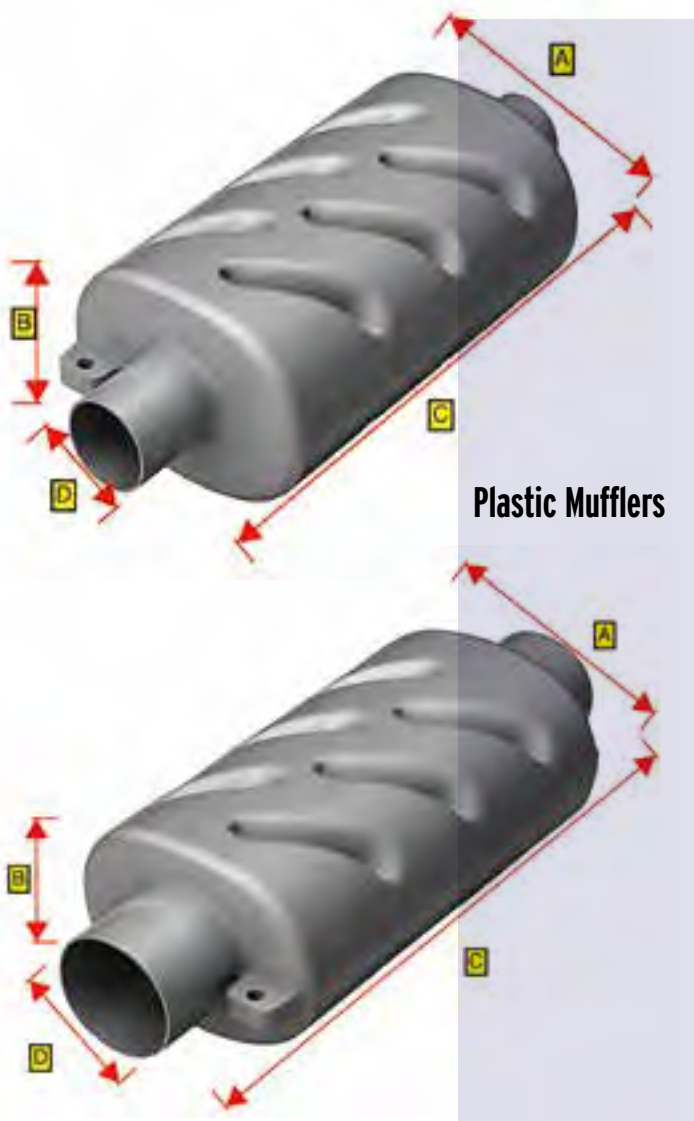

**Plastic Mufflers**

Thanks to the design of these mufflers, the noise reduction is considerable

	D (mm)	A (mm)	B (mm)	C (mm)
<b>Item Code 486230</b>	40	150	105	375
<b>Item Code 486231</b>	45	150	105	375
<b>Item Code 486232</b>	50	150	105	375
<b>Item Code 486233</b>	60	150	105	375
<b>Item Code 486234</b>	75	150	105	375
<b>Item Code 486235</b>	90	183	135	460
<b>Item Code 486236</b>	102	183	135	460

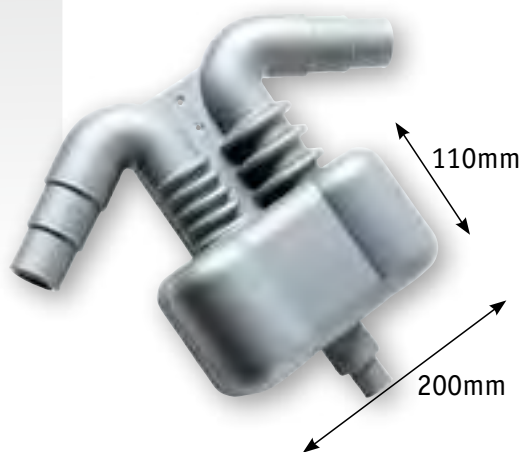

**Gas/water separator for generators**

Works as silencer and separator.  
Gas inlet and outlet connections Ø40/45/50mm.  
Water outlet Ø38 & 15mm. Volume 2.5L.

**Item Code 486220**

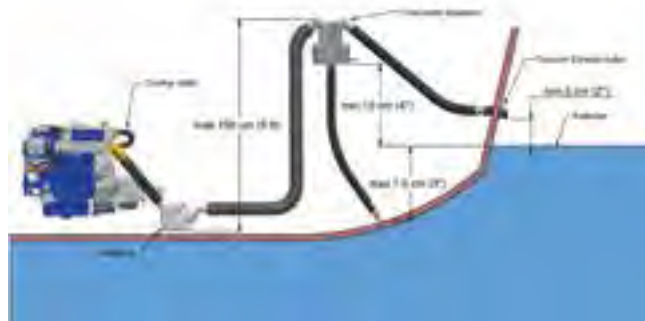

**Exhaust Hose with Lloyd's Approval**

Very flexible Exhaust Hose with Steel Spiral. -25° - +120°C.  
Inlay Black, with green print: "DIESEL EXHAUST HOSE LLOYD'S register 96/00127 (E3) & 96/00126 (E3)"

<b>Item Code 800040</b>	40 x 50mm	<b>Item Code 800075</b>	76 x 86mm
<b>Item Code 800045</b>	45 x 55mm	<b>Item Code 800090</b>	90 x 100mm
<b>Item Code 800050</b>	50 x 62mm	<b>Item Code 800100</b>	102 x 113mm
<b>Item Code 800060</b>	60 x 70mm	<b>Item Code 800127</b>	127 x 137mm
		<b>Item Code 800152</b>	152 x 164mm

**Item Code 486215**

Rubber connector for pipe Ø40/45/50mm.  
With stainless steel mounting ring.

**Transom Exhaust Connection**



For exhaust hose Ø40, 45 and 50mm,  
Transom side connection Ø50mm

- Item Code 486205** 180°
- Item Code 486206** 150°

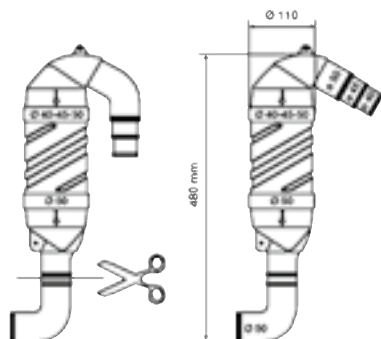

**Plastic Goosenecks**



Plastic water lock with integrated muffler. 8mm Material.  
Provided with a drain plug for winterising.

Item Code	Diameter	Volume	Capacity
486200	40/45/50mm	7l	up to 50HP
486201	55/60/65mm	20l	up to 115HP
486210	75/90mm	33l	up to 150HP
486211	100/115mm	33l	up to 300HP



**Water Lock Mufflers**

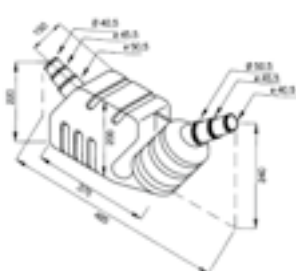

486200

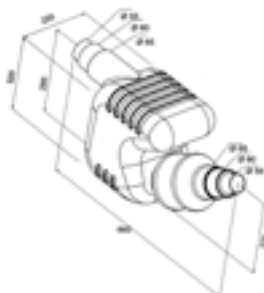

486201

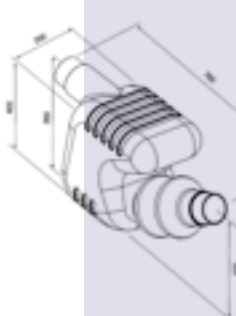

486210



486210



**Brass Hose Pillars**

Item Code 1004A6	1/4" x 6mm	Item Code 1004E30	1" x 30mm
Item Code 1004A8	1/4" x 8mm	Item Code 1004E32	1" x 32mm
Item Code 1004A10	1/4" x 10mm	Item Code 1004F32	1 1/4" x 32mm
Item Code 1004B10	3/8" x 10mm	Item Code 1004F38	1 1/4" x 38mm
Item Code 1004B13	3/8" x 13mm	Item Code 1004F40	1 1/4" x 40mm
Item Code 1004B15	3/8" x 15mm	Item Code 1004G38	1 1/2" x 38mm
Item Code 1004C14	1/2" x 14mm	Item Code 1004G40	1 1/2" x 40mm
Item Code 1004C16	1/2" x 16mm	Item Code 1004G45	1 1/2" x 45mm
Item Code 1004C20	1/2" x 20mm	Item Code 1004G50	1 1/2" x 50mm
Item Code 1004D13	3/4" x 13mm	Item Code 1004J50	2" x 50mm
Item Code 1004D16	3/4" x 16mm	Item Code 1004J60	2" x 60mm
Item Code 1004D20	3/4" x 20mm	Item Code 1004K70	2 1/2" x 70mm
Item Code 1004D25	3/4" x 25mm	Item Code 1004L80	3" x 80mm
Item Code 1004E25	1" x 25mm		



**Brass Skin Fittings**

Item Code 001121B	3/8"	Item Code 001121F	1 1/4"
Item Code 001121C	1/2"	Item Code 001121G	1 1/2"
Item Code 001121D	3/4"	Item Code 001121J	2"
Item Code 001121E	1"	Item Code 001121K	2 1/2"
		Item Code 001121L	3"



**Full Flow Ball Valves Nickel-Plated Brass**

Item Code 001540A	1/4"	Item Code 001540F	1 1/4"
Item Code 001540B	3/8"	Item Code 001540G	1 1/2"
Item Code 001540C	1/2"	Item Code 001540J	2"
Item Code 001540D	3/4"	Item Code 001540K	2 1/2"
Item Code 001540E	1"		



**Brass graded Water Scoops**

Item Code 001120B	3/8"	Item Code 001120F	1 1/4"
Item Code 001120C	1/2"	Item Code 001120G	1 1/2"
Item Code 001120D	3/4"	Item Code 001120J	2"
Item Code 001120E	1"		



**Brass Skin Fittings with Hose Pillar**

Item C 001123B15	3/8" x 15mm	Item C 001123G451	1 1/2" x 45mm
Item C 001123C18	1/2" x 18mm	Item C 001123J57	2" x 57mm
Item C 001123D24	3/4" x 24mm	Item C 001123K70	2 1/2" x 72mm
Item C 001123E30	1" x 30mm	Item C 001123L80	3" x 80mm
Item C 001123F40	1 1/4" x 40mm		



**Stainless Steel Hose Clamps**

For very strong clamping (10-45kg/cm<sup>2</sup>)  
With bolt and bevelled edges. Re-usable  
- Item Codes FA2602 - FA2630. Supplied per piece.

Item Code	Ømm	H(mm)	L(mm)
FA2602	29- 31	20x0,8	6x 50
FA2603	32- 35	20x0,8	6x 50
FA2604	36- 39	20x0,8	6x 50
FA2605	40- 43	20x0,8	6x 50
FA2606	44- 47	22x1,2	7x 60
FA2607	48- 51	22x1,2	7x 60
FA2608	52- 55	22x1,2	7x 60
FA2609	56- 59	22x1,2	7x 60
FA2610	60- 63	22x1,2	7x 60
FA2611	64- 67	22x1,2	7x 60
FA2612	68- 73	24x1,5	8x 75

Hose clips with punched wedged thread and fixed housing  
- Item Codes FA2631-FA2647

Item C	Ømm	H(mm)	Pack	Nm
FA2631	8 - 12	12,7	4	3
FA2632	11 - 20	12,7	4	3
FA2633	13 - 23	12,7	4	3
FA2634	14 - 27	12,7	4	3
FA2635	21 - 38	12,7	30	3
FA2636	25 - 40	12,7	30	3
FA2637	27 - 51	12,7	30	4
FA2638	40 - 64	12,7	20	4
FA2639	50 - 70	12,7	20	4

stainless steel  
316



**Cold Water Hose**

Transparent PVC hose with steel spiral inlay  
Temp. -15°C - +65°C Max. bar at +20°C (working pressure):

Item Code 861016	10 x 16mm	7 bar
Item Code 861319	13 x 19mm	6 bar
Item Code 861623	16 x 23mm	6 bar
Item Code 862027	20 x 27mm	5 bar
Item Code 862533	25 x 33mm	5 bar
Item Code 862836	28 x 36mm	4,5 bar
Item Code 863241	32 x 41mm	4 bar
Item Code 863847	38 x 47mm	4 bar

Nickel plated brass body with stainless steel 316 strainer and transparent cover of **grilamid tr55** with neoprene O-ring. Easy to open with supplied key.

**RINA MAC Certificate**

Item Code	Conn.	Flow @ 0,1 bar	Flow @ 0,1 bar	H mm
001160B	3/8"	1800 l/u	5750 l/u	108
001160C	1/2"	2550 l/u	8180 l/u	108
001160D	3/4"	4750 l/u	15160 l/u	108
001160E	1"	7500 l/u	23800 l/u	136
<b>Parts:</b>				
001460	Cover			
001460/A	O-Ring (neoprene)			
001460/C	Strainer for 001160B-D			
001460/C-E	Strainer for 001160E			
001460/E	Spare key			

**Cooling Water Strainer Brass**



Nickel plated bronze body with stainless steel 316 strainer and transparent polycarbonate cover with neoprene O-ring and U-profile (**Item Code 001464GUK**) for the strainer.

**RINA DIP Certificate**

Item Code	Conn.	Flow @ 0,1 bar	Flow @ 0,1 bar	H mm	Strainer Øxh mm
001164E	1"	7950 l/u	25500 l/u	144	74x100
001164F	1-1/4"	12500 l/u	40100 l/u	178	98x131
001164G	1-1/2"	19100 l/u	61250 l/u	178	98x131
001164J	2"	30000 l/u	96200 l/u	215	124x160
001164K	2-1/2"	42600 l/u	134000 l/u	243	155x188
001164L	3"	58400 l/u	184000 l/u	276	155x215

**Cooling Water Strainer Bronze**



for info and parts  
CHECK  
[www.allpa-marine.com](http://www.allpa-marine.com)

Nickel plated bronze body with stainless steel 316 strainer and transparent polycarbonate cover with neoprene O-ring.

**RINA DIP Certificate**

Item Code	Conn.	Flow @ 0,1 bar	Flow @ 0,1 bar	H mm
001162B	3/8"	1400 l/u	4300 l/u	117
001162C	1/2"	2400 l/u	7500 l/u	117
001162D	3/4"	3800 l/u	12000 l/u	151
001162E	1"	5700 l/u	17900 l/u	151
001162F	1-1/4"	8800 l/u	27700 l/u	176
001162G	1-1/2"	12800 l/u	40600 l/u	193
001162J	2"	19900 l/u	63000 l/u	216

**Cooling Water Strainer Bronze**



Plastic with transparent cover

**Item Code 090150** 3/4" 2.800l/h

Dimensions: H=75-110mm, D=145-165mm

**Item Code 090325** 1-1/2" 6.650l/h

Dimensions: H=125-175mm, D=145-165mm

Spares for 090150 & 090325:

**Item Code 090150/G** Rubber ring large

**Item Code 090150/K** Plastic ring small

**Extra Robust Cooling Water Strainers**



Plastic filter with mounting bracket & transparent cover

**Item Code 483600** 150l/min

Hose Connections Ø19-25mm

D=150mm, H=132mm (204mm incl. hose pillars)

**Item Code 483610** 300l/min

Hose Connections Ø32-38mm

D=150mm, H=132mm (204mm incl. hose pillars)

**Cooling Water Strainers Quick Fit**



**Hydrolock**

Hydrolock (hydrostatic lock) occurs when water ingresses into the cylinders mostly as a result of backflow through the exhaust manifold. Since most common liquids are incompressible the piston cannot complete its travel which will often result in catastrophic damage like bent or broken connection rods, fractured head and block, crankshaft and bearing damage. A good, water cooled exhaust system should therefore be equipped with a syphon breaker and a water lock with sufficient capacity.

However, there is another, rather unknown cause of Hydrolock:

**The Risk of Hydrolock due to long start attempts.**

If long or several start attempts are needed because the engine will not run, for example the first start attempt after winter time of an engine with a water cooled exhaust system, one should be prepared that hydrolock could occur. The explanation is as follows:

With a running engine cooling water is injected into the exhaust manifold and pressed outside through the water lock and gooseneck.

Lengthy periods of turning the starter can cause water to build up in the exhaust line to the point it backflows through the exhaust manifold and fills the cylinders.

Hydrolock damage will be very likely.

If lengthy periods of starting are necessary for any reason, then temporarily close the seacock of the cooling system and remove the neoprene impeller from the water pump as the impeller cannot run dry.

As soon as the engine fires, it may easily run without water for a little while. However, plastic and rubber parts of the exhaust line will not withstand hot exhaust gases much longer as thirty seconds.

Source: Waterkampioen.

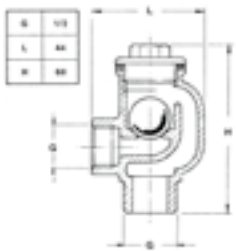
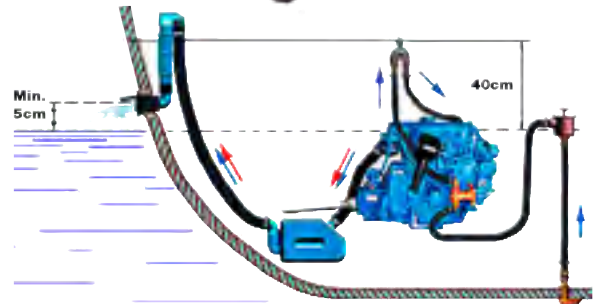

**Air Vent Kits**

Installation of an air vent into the exhaust and cooling system is of great importance if the water injection point is only 150mm above the waterline or below.

The EPDM Rubber floating check ball may eventually be removed to get a complete open system if there is for example, a chance of stoppage due to salt crystallisation

The air vent kit comes complete with brass T-fitting, 2 x elbow fittings and hose pillars.

**Item Code 001250/13** For Ø13mm hose

**Item Code 001250/16** For Ø16mm hose

**Item Code 001250/20** For Ø20mm hose

**Item Code 001250/32** For Ø32mm hose

**Item Code 001250/38** For Ø38mm hose



**Johnson Pump Syphon breaker**

**Features:**

- Non corrosive
  - With vacuum valve
  - Easy to install
  - Does not leak
  - 5 Hose connection sizes
- Plastic syphon breaker for water cooled engines.

**Item Code 66-09-47316-01** 12mm

**Item Code 66-09-47316-02** 16mm

**Item Code 66-09-47316-03** 19mm

**Item Code 66-09-47316-04** 22mm

**Item Code 66-09-47316-05** 25mm

**Item Code 66-09-47316-06** Servicekit



**Item Code 486226**

Plastic  
38-32-28,5-25-22-19-16-13mm

**Universal Hose Connector**



**Item Code 486227**

Plastic  
58-50-45-39-32mm

**Universal Hose Connector**



**Item Code 486225**

Plastic  
38-32-28,5-25-22-19-16-13mm

**Syphon Breaker**

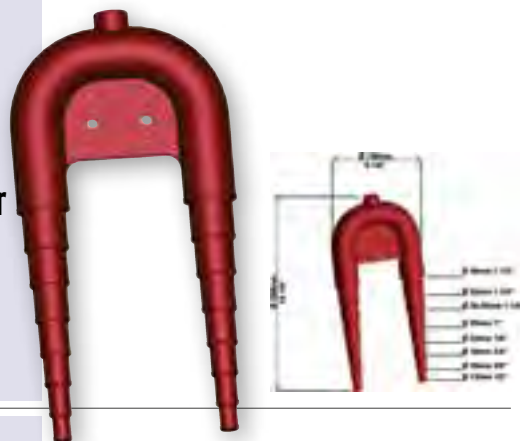

PVC Hose with braided polyester inlay

- Transparent, food quality
- Temp. -20°C - +60°C. Maxbar at +20°C (working pressure):

<b>Item Code 800814</b>	14 x 8mm	20 bar
<b>Item Code 801319</b>	19 x 13mm	15 bar
<b>Item Code 801521</b>	21 x 15mm	14 bar
<b>Item Code 801927</b>	27 x 19mm	14 bar
<b>Item Code 802534</b>	34 x 25mm	13 bar
<b>Item Code 803242</b>	42 x 32mm	10 bar
<b>Item Code 803848</b>	48 x 38mm	8 bar
<b>Item Code 805060</b>	60 x 50mm	6 bar

**Cold Water Hose**



Kink proof PVC suction/pressure hose with steel spiral inlay

- Transparent
- Temp. -15°C - +65°C. Max bar at +20°C (working pressure)

<b>Item Code 861016</b>	10 x 16mm	7 bar
<b>Item Code 861319</b>	13 x 19mm	6 bar
<b>Item Code 861623</b>	16 x 23mm	6 bar
<b>Item Code 862027</b>	20 x 27mm	5 bar
<b>Item Code 862533</b>	25 x 33mm	5 bar
<b>Item Code 862836</b>	28 x 36mm	4,5 bar
<b>Item Code 863241</b>	32 x 41mm	4 bar
<b>Item Code 863847</b>	38 x 47mm	4 bar

**Cold Water Hose**





**Fuel Hoses**  
suitable for oil,  
petrol & diesel  
with approval

**SAE J1527 B2 and ISO 8469 TYPE B Class Standard**

**Item Code 002000** 8 x 13mm Grey, 25 Meters

Temperature range: -30°C to + 80°C



**Exhaust Hose**  
with Lloyd's  
Approval

Very flexible exhaust hose with steel spiral inlay  
Black with green tape print: "Marine Wet Exhaust -  
Approved Lloyd's Register no. 96/00127 (E3) & 96/00126 (E3)"

<b>Item Code 800040</b>	40 x 50mm
<b>Item Code 800045</b>	45 x 55mm
<b>Item Code 800050</b>	50 x 62mm
<b>Item Code 800060</b>	60 x 70mm
<b>Item Code 800152</b>	152 x 164mm
<b>Item Code 800075</b>	76 x 86mm
<b>Item Code 800090</b>	90 x 100mm
<b>Item Code 800100</b>	102 x 113mm
<b>Item Code 800127</b>	127 x 137mm



**Diesel & Petrol**  
Resistant Rubber  
Hose

Suitable for diesel, bio-diesel and unleaded fuel.

Standards: • SAE J 1527 • USCG A1 R1  
• ISO 7840 A1 CE

Approved: • CE • CE 0474 RINA  
• LLOYD'S REGISTER

• Colour: Black with print  
• Temperature range: -30°C + 100°C

<b>Item Code 002012</b>	6 x 16mm – max 14 bar
<b>Item Code 002013</b>	8 x 17mm – max 14 bar
<b>Item Code 002060</b>	10 x 19mm – max 14 bar
<b>Item Code 002062</b>	12.5 x 22mm – max 12 bar
<b>Item Code 002014</b>	16 x 26mm – max 10 bar



**Diesel & Petrol**  
Resistant Rubber  
Hose

Inner Material: Nitrile, Outside: Neoprene

• Colour: Black with print  
• Working Pressure: 10bar  
• Burst Pressure: 30bar  
• Static wire R<1W

<b>Item Code 831927</b>	19 x 27mm
<b>Item Code 831017</b>	10 x 17mm
<b>Item Code 831322</b>	13 x 22mm
<b>Item Code 831623</b>	16 x 23mm



**Diesel & Petrol**  
Resistant Rubber  
Hose with Steel  
Spiral Inlay

Suitable for diesel, bio-diesel and unleaded fuel.

Standards: • SAE J 1527 • USCG A1 R2  
• ISO 7840 A1 CE

Approved: • CE • CE 0474 RINA • LLOYD'S REGISTER

• Colour: black with red label with Print  
• Temp. range: -30° C to + 100° C

<b>Item Code 852532</b>	25 x 32mm – max 10 bar
<b>Item Code 853245</b>	32 x 44mm – max 10 bar, with steel spiral inlay
<b>Item Code 853852</b>	38 x 51mm – max 10 bar, with steel spiral inlay
<b>Item Code 855065</b>	51 x 64mm – max 10 bar, with steel spiral inlay

**Item Code 078650** 12V

Capacity up to 90-120m<sup>3</sup>/h. Water resistant, white colour  
A = 76mm, B = 127mm, C = 108mm

**Extraction Ventilator for Engine Rooms**



**Item Code 078250** Capacity 207m<sup>3</sup>/h

212 x 135 (103) x 108 (LxBxH)  
Plastic Housing with Ø75mm hose connections. 12V-4,5A

**Extraction Ventilator for Engine Rooms**



Ignition Protected. Capacity 280m<sup>3</sup>/h. Plastic housing.  
Hose Connection Inlet: Ø75mm.  
Hose Connection Outlet: Ø72mm.

**Item Code 001212** Blower 12V

**Item Code 001224** Blower 24V

**Extraction Ventilator for Engine Rooms**



**Flange Mount**

Item Code	Description	Capacity
66-80-47417-01	AirV 4-550 12V (11,5A)	550m <sup>3</sup> /h
66-80-47417-02	AirV 4-550 24V ( 7,0A)	550m <sup>3</sup> /h

Ø110mm Inlet, Ø103mm Outlet 290x257x150mm (hxwxl)

66-80-47418-01	AirV 4-750 12V (19,0A)	750m <sup>3</sup> /h
66-80-47418-02	AirV 4-750 24V (11,0A)	750m <sup>3</sup> /h

Ø150mm Inlet, Ø103mm Outlet. 290x257x150mm (hxwxl)

**Flex Mount**

Item Code	Description	Capacity
66-80-47420-01	AirV 4-550 12V (11,5A)	550m <sup>3</sup> /h
66-80-47420-02	AirV 4-550 24V ( 7,0A)	550m <sup>3</sup> /h

Ø110mm Inlet, Ø103mm Outlet. 290x257x150mm (hxwxl)

66-80-47421-01	AirV 4-750 12V (19,0A)	750m <sup>3</sup> /h
66-80-47421-02	AirV 4-750 24V (11,0A)	750m <sup>3</sup> /h

Ø150mm Inlet, Ø103mm Outlet. 290x257x150mm (hxwxl)

"Ignition protected". CE-Approved conform ISO 9097, ISO 8846, ISO 10133, EN 55014 in accordance with N.M.M.A., USCG 183.410

**Johnson Pump®**

**Extraction Ventilator for Engine Rooms**



**Suitable for continuous duty**



**Item Code 018300** Extraction Ventilator 12V (6A)

Capacity 750m<sup>3</sup>/h. "Ignition protected"  
Suitable for bulkhead mounting  
Ø191mm (bulkhead side), Ø176mm, L = 158mm

**Extraction Ventilator for Engine Rooms**



R.I.N.A.-Approved according ISO 8846 & EN55814 (DIP0379Y1/001-002-003-004)



### UFO-Stainless Steel Deck Ventilator

Very good ventilation. Absolutely spray-waterproof  
100% Easy closing from inside. Provided with stainless steel fly screen. Step-on safe Very suitable for sailing yachts  
Incl. plastic grill to finish the interior

**Item Code 048976** Outer Ø185mm, Cut out Ø85mm

**Item Code 048977** Outer Ø240mm, Cut out Ø123mm



### MUSHROOM Stainless Steel Ventilator

Very good Ventilation  
100% Easy closing from inside. No Step  
Incl. stainless steel fly screen and plastic counter flange

**Item Code 048978** Outer Ø120mm, Cut out Ø85mm

**Item Code 048979** Outer Ø150mm, Cut out Ø123mm

**Item Code 048980** Outer Ø175mm, Cut out Ø150mm



### Solar Power Ventilator Stainless steel

**Item Code L6470225** Solar Power Ventilator with built-in battery for 24h ventilation.  
Incl. switch. Dims. Ø216mm, cut out size Ø118mm.  
Built-in depth 35mm. Total height 101,6mm (2-3/4")  
Cap. ± 20m<sup>3</sup>/Hr.

**Item Code L6470226** Spare Battery

**GB** Charge up before use  
**D** Vor Gebrauch aufladen  
**NL** Opladen voor het gebruik



stainless steel  
**316**

### Stainless Steel Shell Ventilator

Can be screwed directly on the hull or superstructure.  
Ideal for ventilation of engine rooms Mounting Plate provides Water Guard. Dims. 126x143x47mm (LxWxH)

**Item Code 048975** Shell Ventilator

**Item Code 048981** Mounting plate  
with hose connection Ø76mm



### Ventilation Hose

Ventilation hose (Price per roll)

**Item Code 817606** Ø76mm, L= 6m (suction side blower)

**Item Code 180300** Ø80mm, L= 10m (suction side blower)

**Item Code 180315** Ø150mm, L= 10m (suction side blower)

**Item Code 180310** Ø100/102mm, L= 10m (pressure side blower)

- Item Code 078140** 127 x 115mm (L x B)
- Item Code 078141** 230 x 115mm (L x B)
- Item Code 078142** Ø102mm

**Stainless Steel  
"LOUVRES"**

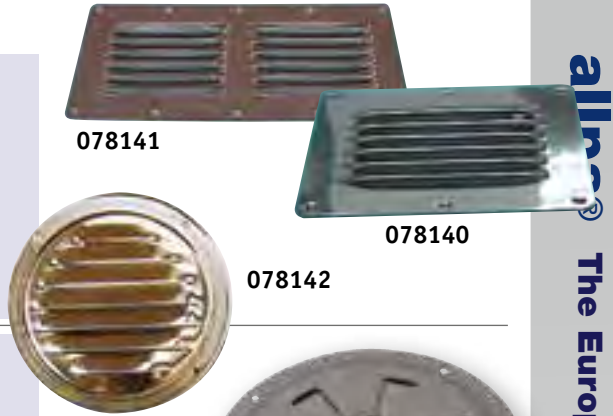

- Item Code 098145** Butterfly Vent D=102mm
  - Item Code 098146** Butterfly Vent D=127mm
- Material thickness 1mm

**Butterfly Vent  
Stainless Steel  
A304**

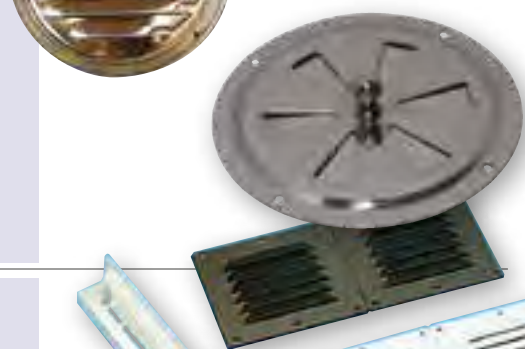

- Item Code 006750/B** 255x115mm, black
- Item Code 006750/W** 255x115mm, white
- Item Code 006755** 420x120mm,  
Built-in type with water guard

**Plastic  
"LOUVRES"**



- |                         | Cut out sizes (LxWxH) | Outer sizes (LxW) |
|-------------------------|-----------------------|-------------------|
| <b>Item Code 078130</b> | 240x90x29mm           | 265x112mm         |
| <b>Item Code 078131</b> | 305x87x27mm           | 328x112mm         |
| <b>Item Code 078132</b> | 505x89x27mm           | 528x112mm         |

**Stainless Steel  
„LOUVRES“**



- Item Code 078147** 80x80mm, white
- Item Code 078148** 80x80mm, black
- Item Code 078145** 80x80mm, with hose connection 66mm.  
White
- Item Code 078146** 80x80mm, with hose connection 66mm.  
Black

**Plastic Grills**



- Item Code 078120** 55x53x22mm (LxWxH)
- Item Code 078121** 40x44x16mm (LxWxH)
- Item Code 078123** 118x120x45mm (LxWxH)

**Stainless Steel  
316  
Midget Ventilators**



Very fine cast (by lost wax method) ventilator  
Oval shaped model. Inside white coated  
Dims. A= 101 B= 254 C= 128mm

- Item Code 078127** Cowl Ventilator  
This model comes complete with S/S 4"  
male deck ring with lock cover

**Stainless Steel  
Cowl Ventilators**



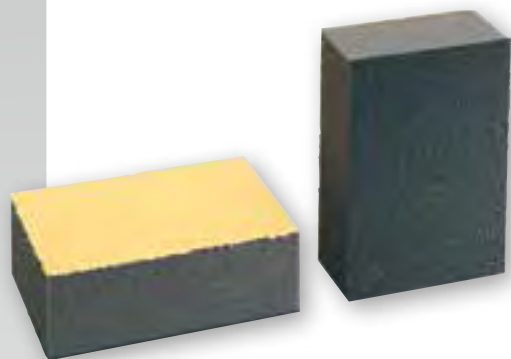
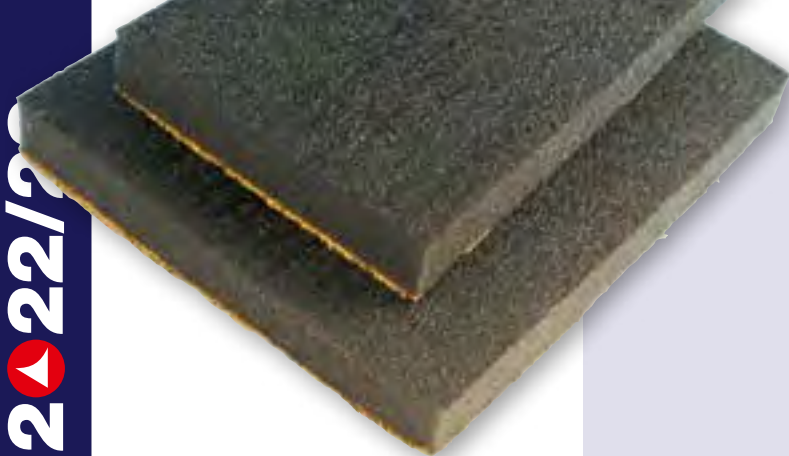

### Dempflex-Absorbel Sound Deadening Plates

Especially developed for sound deadening.

#### Features:

- Polyurethane foam with open cells and with a very thin but strong black PU-layer
- Very good sound deadening quality also for high frequencies
- Flame resistant according to DIN 53438, MVSS 302
- Top layer resistant against spray water, oil, gasoline, diesel, hydrocarbon, solvents and similar substances
- Top layer prevents penetration of liquids and fumes
- Suitable for inside applications
- Aging resistant
- Temperature range -30° to +90°C.

#### Dimensions:

- Dempflex-Absorbel 30: 1400 x 1000 x 30mm, weight 0.9kg/m<sup>2</sup> (without glue)
- Dempflex-Absorbel 50: 1400 x 1000 x 50mm, weight 1.5kg/m<sup>2</sup> (without glue)

#### Application:

In nautical-, automotive-, aerospace-, transport- and electronic industry. Very suitable for sound isolation of engine rooms.

- |                         |                                       |
|-------------------------|---------------------------------------|
| <b>Item Code 700350</b> | Dempflex-Absorbel 30mm                |
| <b>Item Code 700351</b> | Dempflex-Absorbel 30mm, self-adhesive |
| <b>Item Code 700550</b> | Dempflex-Absorbel 50mm                |
| <b>Item Code 700551</b> | Dempflex-Absorbel 50mm, self-adhesive |

Prevents penetration of liquids and fumes though seams



### Oil change pump F3B-19 - "Oil Change"

The Johnson F3B-19 Oil Change Pump is a reversible rubber impeller pump with integrated quick reversing switch. The pump is designed to remove old oil from the engine, and then with the integral reversing switch., the flow direction can be changed to pump a measured amount of new oil back into the engine.

- |                                 |                       |
|---------------------------------|-----------------------|
| <b>Item Code 66-10-24760-01</b> | F3B19 Oil change, 12V |
| <b>Item Code 66-10-24760-02</b> | F3B19 Oil change, 24V |
| <b>Item Code 66-09-8435-9</b>   | Replacement Impeller  |

### Johnson Pump®

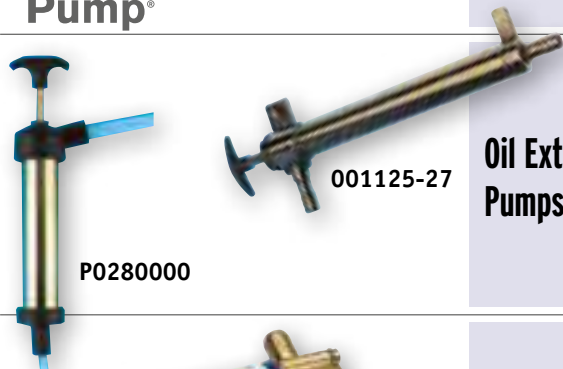

### Oil Extraction Pumps

Can be mounted on the engine  
Extra heavy, brass execution

- |                         |                |
|-------------------------|----------------|
| <b>Item Code 001125</b> | Capacity 52cc  |
| <b>Item Code 001127</b> | Capacity 100cc |

- |                           |               |
|---------------------------|---------------|
| <b>Item Code P0280000</b> | Capacity 80cc |
|---------------------------|---------------|



### Electrical Oil Extraction Pump

Capacity at 20°C with oil type SAE-20:

Ø14mm - 480l/h

Ø8mm - 75l/h

Self priming up to 1m

- |                        |           |
|------------------------|-----------|
| <b>Item Code 06132</b> | 12V / 10A |
| <b>Item Code 06133</b> | 24V / 5A  |
| <b>Item Code 06130</b> | Hose kit  |

These Air Heating Systems must be connected to the closed.Circuit Cooling System of the boat's engine.  
 The heating unit is heated by the cooling liquid of the engine.  
 An electric blower transports the heated air to the desired outlet.  
 Cooling-Liquid-Hose-Connection: 16mm.  
 Hot-Air-Hose-Connection: 50mm

**3 models:**

- MINIPASSAD** with 2-Speed-Fan, Heating Power 4.2kW, 12 and 24V
- MAXIPASSAD** with 3-Speed-Fan, Heating Power 7.0kW, 12 and 24V
- FLEXY 7** with 3-Speed-Fan, Heating Power 5.0kW, 12 and 24V

**ABS - Housing**

Dims.: 115x272x241mm (hwxwd)  
 Heating Power: 4,2kW at 80°C engine cooling liquid temperature  
 Current draw: 5,8A / 12V - 2,9A / 24V  
 Weight: 1,7kg  
 Air Displacement: 250m³/h  
 Sound Level: 65dBa

**The complete kit consists of:**

- 12m aluminum air hose
- 4m cooling liquid hose
- 2 x Hot Air Outlet with adjustable tilting flaps, 360° swivelling
- 3-Position Fan Switch (1-0-2) (087124)

**Item Code 087200** MINIPASSAD 12V - complete kit  
**Item Code 087201** MINIPASSAD 24V - complete kit



Minipassad

**ABS - Housing**

Dims.: 147x377x289mm (hwxwd)  
 Heating Power: 7,0kW at 80°C engine cooling liquid temperature  
 Current draw: 12,5A / 12V - 6,2A / 24V  
 Weight: 3,2kg  
 Air Displacement: 450m³/h  
 Sound Level: 68dBa

**The complete kit consists of:**

- 18m aluminum air hose, Ø50mm
- 4m cooling liquid hose, Ø 16x26mm
- 4 x Hot Air Outlet with adjustable tilting flaps, 360° swivelling
- 4-Position Fan Switch (0-1-2-3) (087125)

**Item Code 087202** MAXIPASSAD 12V - complete kit  
**Item Code 087203** MAXIPASSAD 24V - complete kit



Maxipassad

**Stainless Steel - Housing**

Dims.: 240x160x285mm (hwxwd)  
 Heating Power: 5kW @ 80°C engine cooling liquid temperature  
 Current draw: 8,3A / 12V - 4,3A / 24V (Max)  
 Weight: 4,1kg  
 Air Displacement: 330m³/h  
 Sound Level: 62dBa (Min)  
 Fresh Air Adapter available (option)

**The complete kit consists of:**

- 24m aluminum air hose
- 4m cooling liquid hose
- 4 x Hot Air Outlet with adjustable tilting flaps, 360° swivelling
- 4-Position Fan Switch (0-1-2-3) (087125)

**Item Code 087204** Flexy 7 12V - complete kit  
**Item Code 087205** Flexy 7 24V - complete kit



FLEXY 7

**Item Code 087120** Aluminum hose 50mm, price p.meter  
**Item Code 087121** Hot Air Outlet with adjust. tilt. flaps, 360° swivelling

**Item Code 087122** T-Connection  
**Item Code 087123** Hit Cooling Liquid Hose 16mm.Price p.m.  
**Item Code 087106** Fresh Air Adapter for Flexy 7  
**Item Code 087124** 3-Position Fan Switch (1-0-2)  
**Item Code 087125** 4-Position Fan Switch (0-1-2-3)

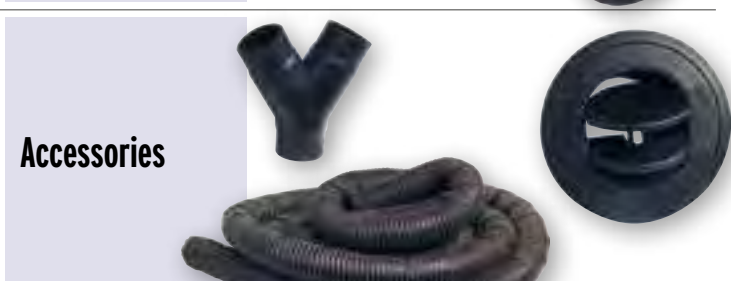

Accessories

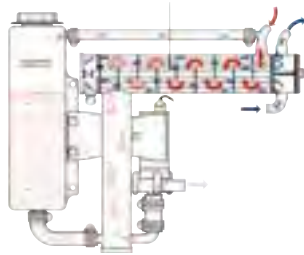
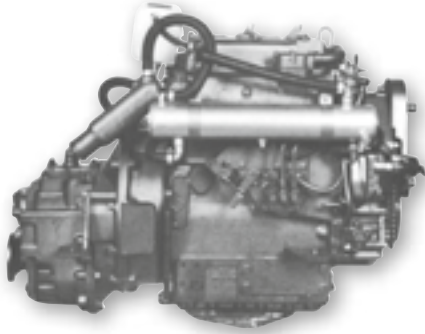

## Martec Heat exchangers

For converting engines with direct cooling to a closed circuit. Fresh Water Cooling with Heat Exchanger. These converting kits are available for a large number of engine models and are directly fitted on the engine.

Furthermore a series of standard Fresh Water Cooling Converting. Kits are available for engines with power up to 40HP. These kits are mounted against a partition next to the engine. All MARTEC Fresh Water Cooling systems come complete with heat exchanger, expansion tank, electric JOHNSON circulation pump, hoses and fitting materials.

### Fresh Water Cooling System for small diesel engines:

Item C.	Motortype	Item C.	Motortype
087001	Volvo MD5 Fenix	087035	BMW D35
087002	Volvo 2001 Fenix	087040	Bukh DV10
087005	Volvo MD6-7	087041	Bukh DV20
087006	Volvo MD2-11		
087007	Volvo MD3-17	087050	Standard Model up to 17HP, partition mounted
087008	Volvo MD5 A-B		
087009	Volvo VP 2001	087051	Standard Model up to 17HP, partition mounted
087010	Volvo VP 2002		
087011	Volvo VP 2003	087052	Standard Model up to 17HP, partition mounted
087020	Yanmar YSB 8-12	087053	Mounting screw for zinc anode
087021	Yanmar YSM 8		
087022	Yanmar 1GM	087504	Zinc anode for Heat Exchanger
087023	Yanmar 2GM/2GM20		
087024	Yanmar 2QM15		
087025	Yanmar 2QM20		
087026	Yanmar 3GM/3GM30		
087027	Yanmar 3QM30		
087028	Yanmar 3HM		
087029	Yanmar YSM12		





Epoxy Powder Coated Stainless Steel frame and springs.  
Easy mounting under manholes or in front of port light.  
Quick opening and closing due to simple and efficient mechanism. Design fits virtually all Hatch sizes.

Item Code	Width mm	Length mm	Hatch Size mm
015100	360	400	330x330
015105	450	500	410x410
015110	500	600	460x500
015115	550	650	510x550
015120	680	780	620x680
015125	910	340	900x320
015130	1300	580	1240x480
015135	940	580	920x450

Awning Blind  
"Sun Set  
Curtain"

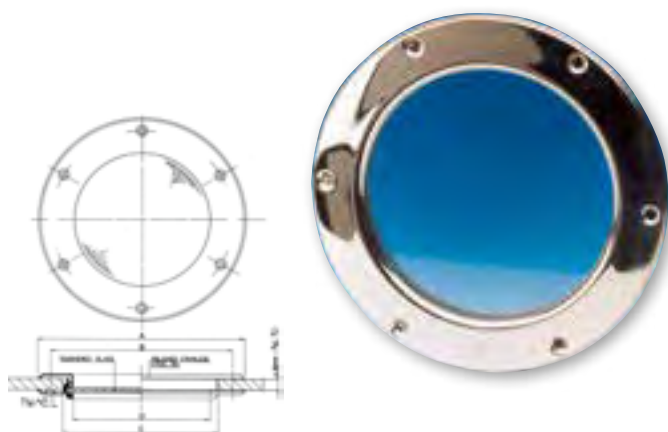

allpa Round  
Portlights  
Stainless Steel

Stainless Steel 304, polished. 100% Watertightness. Unbreakable glass.

**Fixed version - Inside = Outside**

Code	Inside (A)	Hole Pitch (B)	Section (C)	Viewing size (D)	Glass	Steel	Wall thickness
048990	Ø190mm	Ø169mm	Ø141mm	Ø125mm	5mm	1,0mm	4-20mm
048991	Ø215mm	Ø194mm	Ø166mm	Ø150mm	5mm	1,0mm	4-20mm
048995	Ø265mm	Ø237,5mm	Ø220mm	Ø200mm	8mm	1,5mm	4-20mm

Mounting holes Ø5,5mm.

**Opening version - Outside like fixed models – simple clasp**

Code	Inside dim (A)	Hole pitch(B)	Section(C)	Viewing size(D)	Glass	Steel	Wall-thickness	Stainless Steel fly screen
048992	Ø165mm	Ø144mm	Ø116mm	Ø100mm	5mm	1,0mm	4-15mm	048983
048993	Ø190mm	Ø169mm	Ø141mm	Ø125mm	5mm	1,0mm	4-15mm	048984
048994	Ø215mm	Ø194mm	Ø166mm	Ø150mm	5mm	1,0mm	4-15mm	048985



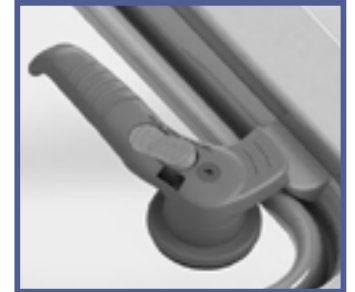

Mounting holes Ø5,5mm.

048998 Adapter Stainless Steel H=29mm for item code 048994

048999 Rubber gasket per meter



Height lower frame: 10mm  
 Height opening lid: 19mm  
 Adjustable stay (except size 18 & 22)  
 Stainless steel hinges

Model	OPAL Satin	frame	 mm	 mm	 mm	 kg
00	73115263	15	211 x 211	42.5	265 x 265	2.5
03	73115264	15	231 x 176	42.5	285 x 230	2.6
10	73106732	15	260 x 260	42.5	314 x 314	3.2
20	73106733	15	347 x 202	42.5	401 x 256	3.5
30	73106734	15	457 x 327	42.5	511 x 381	5.6
40	73106735	15	421 x 421	42.5	475 x 475	6.2
44	73106736	15	442 x 442	42.5	496 x 496	6.7
50	73115267	15	507 x 377	42.5	561 x 431	5.4
54	73106737	15	507 x 392	42.5	561 x 446	7.2
60	73106738	15	507 x 507	42.5	561 x 561	7.9
70	73106739	15	627 x 627	42.5	681 x 681	10.8
18	73115406	15	Ø420	-	Ø474	4.9
22	73115506	15	Ø518	-	Ø572	7.3

**OPAL Hatches**

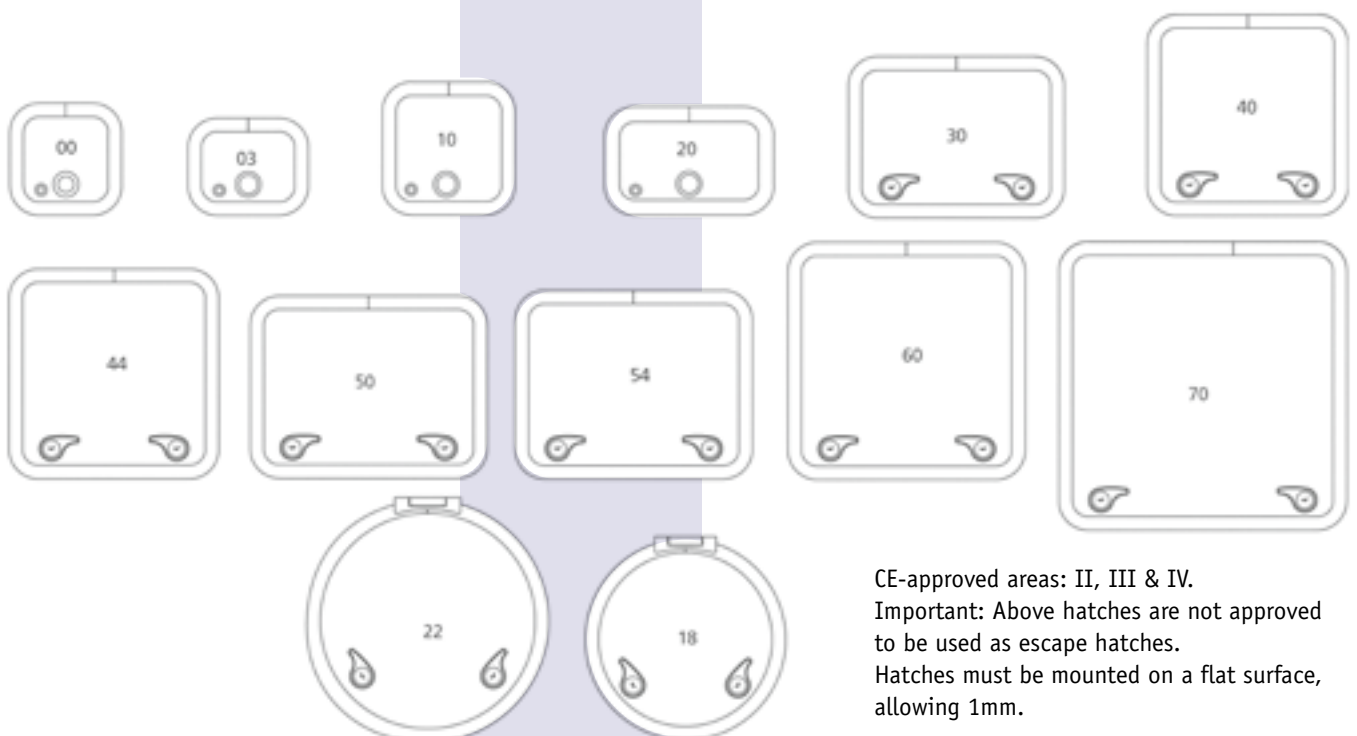





CE-approved areas: II, III & IV.  
 Important: Above hatches are not approved to be used as escape hatches.  
 Hatches must be mounted on a flat surface, allowing 1mm.



## Flush Opal hatches

After pioneering the flush hatch technology on Maricha IV, Goïot is proud to introduce a range of standard flush hatches designed for production series boats. The flush models stem from the Opal range with the same sturdy aluminum frame, telescopic stays and ergonomic handles. A real innovative breakthrough, the flush hatches feature a lid with no metal structure: thanks to a thicker acrylic lid (15mm) and state-of-the-art stainless steel hinges, the lid consists in the mere acrylic pane which definitely brings an additional touch of elegance to the deck.

Model	Item Code	frame	 mm	 mm	 mm	 kg
10	<b>73115518</b>	15	260 x 260	42.5	330 x 330	5.6
44	<b>73115519</b>	15	442 x 442	42.5	512 x 512	7.6
60	<b>73115520</b>	15	507 x 507	42.5	577 x 577	7.9

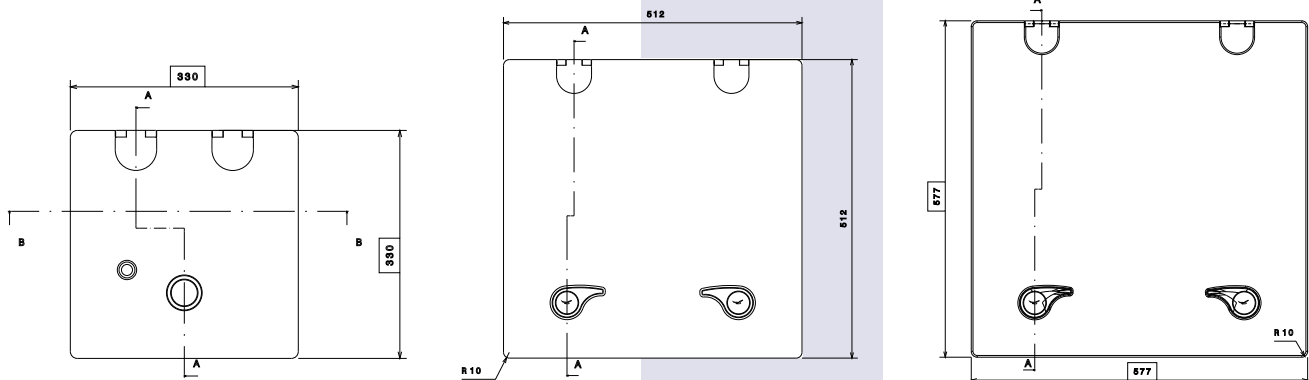



## OPAL Portlights

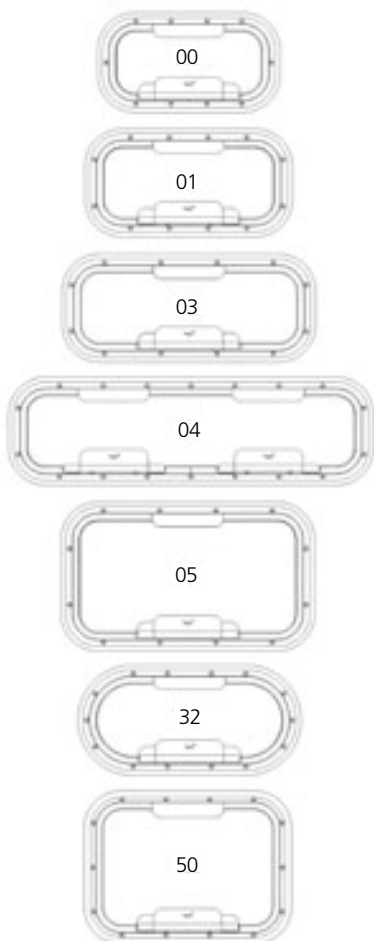

OPAL portlights naturally fit perfectly with OPAL hatches and have some unique features:

- A sturdy frame made of one piece of aluminum, which ensures excellent rigidity, together with a double sealing profile for a perfect water barrier.
- Only one version per model suitable for many wall thicknesses:
  - 5 to 33 mm for folding portholes.
  - 8 to 30 mm for fixed portholes.
- Optimal visibility due to non-obstructing position of the closing trade.
- Open and close with one hand.

### Edit

The portlights must be mounted on a flat surface, with a permitted tolerance of approx. 1 mm.

The portlights are standard equipped with 10 mm thick blue acrylic glass.

### To open





Due to the single, ergonomic handle, the partridge gate can be opened with just one hand.

This trade also distributes the pressure on the entire sealing profile, making an excellent water resistance guaranteed.

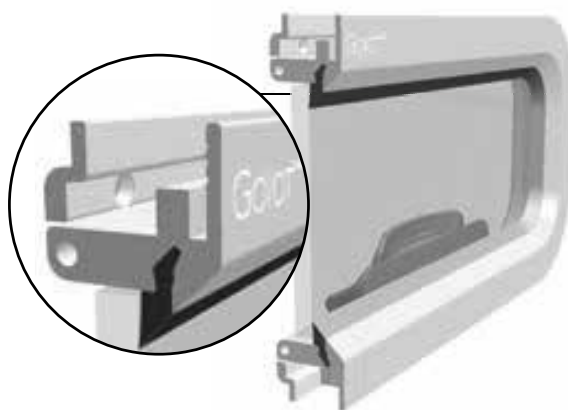
### Watertightness

The Opal portlights have a double sealing system. Upon closure, the first lip holds back the water while the second lip ensures absolute water tightness. The 46 degree profile of the frame ensures excellent drainage and the portholes are therefore also suitable for installation in (sloping) wheelhouse roofs.



Model Satin	Item Code	version	 mm	 mm	 mm	 kg
00	73106928	opening	303 x 156	56	325 x 178	1.8
01	73105268	opening	347 x 171	56	369 x 193	2
03	73115006	opening	429 x 171	56	451 x 193	2.7
04	73105269	opening	627 x 171	56	649 x 193	3.8
05	73106930	opening	429 x 244	56	451 x 266	3.4
32	73105125	opening	375 x 175	87.5	397 x 197	2
50	73105126	opening	347 x 251	56	369 x 273	3

### Mosquito screen for Opal portlights

For the most common sizes (01, 03, 04, 05, 32, 50) a suitable mosquito screen is available.

Model	Item Code	Model	Item Code
01	73106620	03	73115854
04	73106621	05	73115848
32	73106618	50	73106619

### Mosquito Screen



### Accessories for OPAL Hatches

#### Trim ring

- Thickness 68mm
- Return 20mm
- ABS white RAL 9016

#### Shade & mosquito screen

- Folding structure, accordion type
- Fastening with clamps (non visible)
- Colour: white RAL 9016

Model	Trim ring	shade/ flyscreen	Blue acryl glas
00	73115353	-	73106897
03	73115354	-	-
10	73115306	73115175	73106898
20	73115355	73115176	73106899
30	73115356	73115177	73106900
40	73115357	73115178	73106901
44	73106086	73115179	73106902
50	73115439	73115447	-
51	73115442	73115450	-
54	73115358	73115181	73106903
60	73115359	73115182	73106904
64	73115443	73115451	-
65	73115444	73115452	73106905
70	73115392	73115183	73106906
18	73115440	73115448	-
22	73115441	73115449	-

### Shades, Fly Screens, Trim Rings for OPAL

Shade & Fly Screen in one



Item Code	Description
73106896	Gasket per meter for OPAL & OPAL Flush
73106888	Starboard plastic handle
73106889	Port plastic handle
73106890	Handle kit
73115553	Small handle
73106894	Outside cap without hole
73106895	Outside cap with winch hole
73106942	Axis with stay support
73106943	Axis without stay support
73115278	Outside handle axis, port
73115279	Outside handle axis, starboard
73106988	Stay for hatch size 00
73106999	Stay for hatch size 03
73106891	Stay for hatch size 10
73106892	Stay for hatch size 20
73106893	Stay for hatch size 30
73106976	Stay for hatch size 40
73106970	Stay for hatch size 44
73106971	Stay for hatch size 54
73106972	Stay for hatch size 60
73106973	Stay for hatch size 70
73106944	Handle spacer for hatch sizes 00-10-20

### Opal Parts



### Uitzetters



73117514



73115279















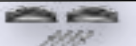





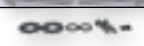

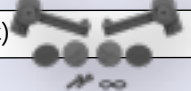
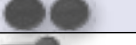

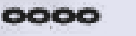



73115904



73106944

Spare parts for  
Goïot Hatches  
(Not OPAL)

Item Code	Tradition-hatch	
73101691	Pair of inside right/left handles	
73101686	Outside handle (x2)	
7395303	Friction ring (x4)	
73100870	Piston locking knob for 80.80 size (x2)	
73101711	Aluminum latch (rivets supplied) for 45.32 / 50.37 / 50.50 / 62.62 and 80.80 sizes (x2)	
7393476	Plastic latch (rivets supplied) for 34.20 (x2)	
7395345	Plastic hinge axle Ø10mm (80.80 hatch) (for 80.80-Series and also for 2-sided opening shutters)	
7395343	Stainless Steel hinge axle Ø8mm	
73100863	Aluminum opening device for 80.80 size (by the unit)	
7393477	Pair of int/ext aluminum handles (right & left)	
7395661	Gasket (Per meter)	
<b>Item Code Cristal-hatch</b>		
7395330	Small inside handle (x2)	
73101704	Pair of large int. handles (with complete montage-set)	
7393480	Inside cap for large handle (x 2)	
73101687	Outside handle (x 2)	
7395303	Friction ring (x 4)	
7393481	Lock (by the unit)	
73101706	Friction set for 24.19 / 24.24 / 35.21 / 36.14 / 36.19 / 36.24 / 49.19 / 49.24 sizes (x 2)	
73101708	Friction set for 42.42 / 44.31 / 44.44 / 44C / 49.36 sizes (x 2)	
73100870	Piston locking knob for 79.79 size (x 2)	
73105020	Pair of int/ext aluminum handles for Cristal hatch (right & left)	
7395658	Gasket (Per meter)	
<b>Item Code Integration-hatch</b>		
73101713	Pair of small inside handles	
73101704	Pair of large int. Handles for 46.33 size	
73101692	Opening stay for 46.33 size (by the unit)	
<b>Item Code Former Evolution-hatch</b>		
7395330	Small inside handle (x 2)	
73101690	Pair of large inside handles (right & left)	
<b>Item Code Universal</b>		
73101715	Glue kit for acrylic glass of shutters and portholes	
73105697	Neoprene glue for hatch gasket (310 ml)	

Screws with flapgrips are available in three size, Stay from 5, 6 and 8mm.

The stainlesssteel spindle moves in a self lubricated nut of bronze. Consequently, the adjustable forces are held very low. The folding handgrips and the hub consists of black anodized aluminum. All the other parts are made of stainless steel AISI 316 (V4A).

Item Code	Breaking-strength(kg)	Working-load(kg)	ØBolt (mm)	Hook (mm)	ØStay (mm)
212183	3000	1500	8	11	5
212184	4800	2300	10	11	6
212186	6800	3300	12	15	8

### Stayscrew with flapgrips

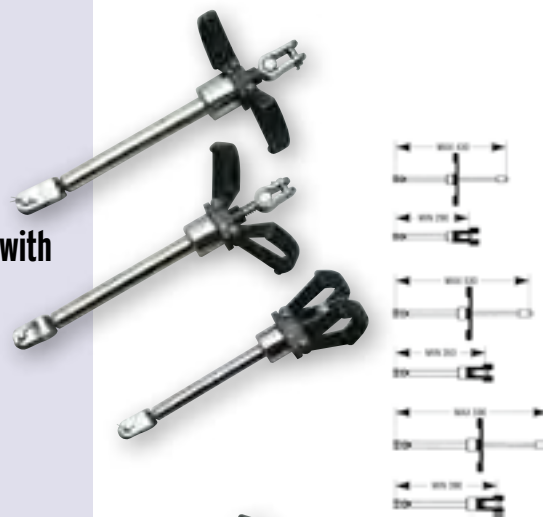

### Stayscrew with Snaphook

Item Code	Breaking-strength(kg)	Working-load(kg)	ØBolt (mm)	Hook (mm)	ØStay (mm)
212187	3000	1500	8	11	5
212188	6800	3300	12	15	6-8

Screws with winchhandle operation are available in three models. Stay from 8-10 and 10-12mm.

These screws work on waterproof stainlesssteel pressure-resistant and are fitted out with self lubricated spindle of bronze. Consequently, a light adjustment of the stay is guaranteed, and under full load, too. These cases consist of aluminum or stainless steel (212700). All the other parts consist of stainless steel AISI 316.

### Stayscrews with winch-handle operation

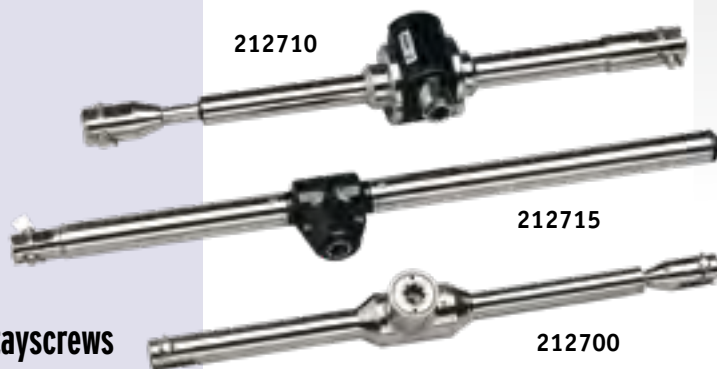

Item Code	Breaking-strength(kg)	Working-load(kg)	ØBolt (mm)	Hook (mm)	ØStay (mm)
212700	7400	3800	14	15	8-10
212715	7400	3800	14	15	8-10
212710	10400	7600	16	17	10-12

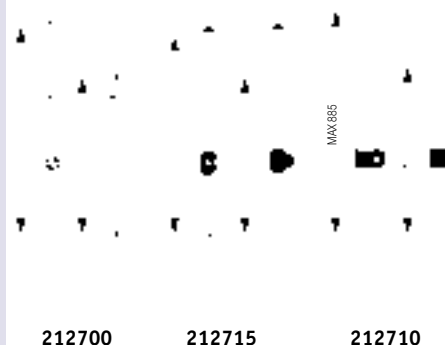

212700 212715 212710



W5

# antal

## Winches

### W5

Snubbing winch without handle. Completely plastic made. Base = 80mm; drum = 50mm; height h= 66mm; weight = 150g; fasteners 4x6mm screws.

Item Code W5



W8/CH

W8/AL

# antal

## Winches

### ONE SPEED: DIRECT

Turn the handle clockwise to engage the single direct gear; the handle turns freely counterclockwise. Model W6 is the smallest and lightest in the range, with a plastic drum, a glass fibre plastic base and an aluminum central rod. Model W7 is similar but with an aluminum drum. Model W8 has an AISI 316 stainless steel central rod, a bronze base and a black anodized aluminum (AL) or chrome-plated bronze (CH) drum mounted on roller bearings.

Item Code	W6	W7/AL	W8/AL
Item Code			W8/CH
Power	6,7	6,7	7,3
Recovery S1 (mm)	188	188	220
Weight(AL) (kg)	0,40	0,70	1,50
Weight(BC) (kg)	-	-	2,10
Screws Nx Ø(mm)	5x Ø6	5x Ø6	5x Ø6

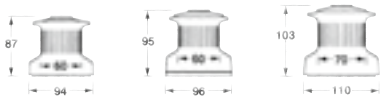

W16/AL

W16/CH

# antal

## Winches

### TWO SPEED: DIRECT AND REDUCED

The first speed is direct (one turn of the drum for each turn of the handle); the second speed is reduced, giving a slower but more powerful force. There are 4 models whose power range from 16 to 47, with bronze base and gears, AISI 316 stainless steel central rod and roller bearings, and black anodized aluminum (AL) or chromeplated bronze (CH) drums.

Item Code	W16/AL	W30/AL	W42/AL
Item Code			W42/CH
Power P1-P2	14,5	28,0	42,5
Recovery S1-S2(mm)	220/110	235/60	250/37
Weight(AL) (kg)	2,00	2,80	4,00
Weight(BC) (kg)	2,90	3,80	6,00
Screws Nx Ø(mm)	5x Ø6	5x Ø6	5x Ø6



W52/CH

W52/AL

# antal

## Winches

### TWO REDUCED SPEED

Quick and powerful operation is obtainable with the first reduced speed, then with increasing load, simply wind in the opposite direction and second gear and maximum power is automatically selected.

Marine bronze is used for gears, AISI 316 stainless steel for central rod and roller bearings, hard black anodized aluminum (AL) or chrome-plated bronze (CH) for the drum. The new-style bronze and aluminum base is of three-part pre-assembled 1 construction (produced by the CNC process) which is lighter than the traditional bronze version and makes maintenance even simpler.

\* The most chromed bronze versions are also available in polished (yellow) bronze

Item Code	W44/AL	W48/AL	W52/AL	W60/AL
Item Code	W44/CH	W48/CH	W52/CH	W60/CH
Power	20.0/43.0	19.0/47.4	14.9/51.1	18.7/61.2
Recovery S1-S2(mm)	81/38	65/36	107/31	85/26
Weight (AL) (kg)	7.00	8.00	10.90	11.70
Weight (CH) (kg)	9.20	10.00	14.10	15.20
Screws NxØ(mm)	6x Ø8	6x Ø8	6x Ø8	6x Ø10





# self-tailing XT winches

## *antal*



XT30/AL

XT30/CH

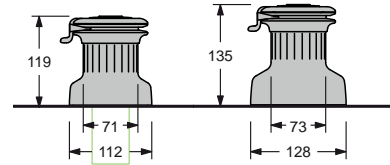

### ONE REDUCED SPEED WINCH XT16 - XT30

The two smallest models (XT16 and XT30) have a single reduced speed, giving a slow but powerful gear. The handle turns freely the other way. Both available in chrome (CH) or hard black alloy (AL).

#### ONE SPEED WINCHES

ITEM CODE	XT16/AL	XT30/AL
ITEM CODE	XT16/CH	XT30/CH
POWER P1	14	28
RECOVERY S1 (mm)	115	58
Ø LINE (mm)	6 / 10	6 / 10
WEIGHT AL (kg)	2.4	2.7
WEIGHT CH (kg)	3.1	3.8
SCREWS N x Ø (mm)	5 x Ø6	5 x Ø6

### TWO SPEED WINCHES: DIRECT, REDUCED XT16.2 - XT30.2

The addition of a direct speed to the above described models gives a faster recovery gear, which, combined with reduced weight and an automatic self-tailing for very thin lines, makes these models the best choice for racing.

#### TWO SPEED WINCHES

ITEM CODE	XT16.2/AL	XT30.2/AL
ITEM CODE	XT16.2/CH	XT30.2/CH
POWER P1-P2	7.0 / 14	7.0 / 28
RECOVERY S1-S2 (mm)	229 / 115	229 / 58
Ø LINE (mm)	6 / 10	6 / 10
WEIGHT AL (kg)	2.6	2.9
WEIGHT CH (kg)	3.0	3.7
SCREWS N x Ø (mm)	5 x Ø6	5 x Ø6



XT52/AL

XT52/CH

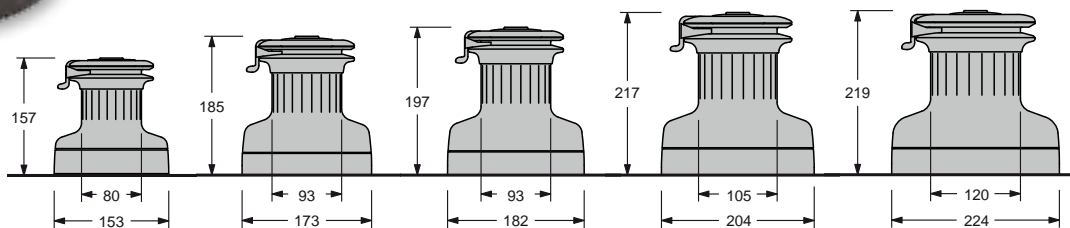

### TWO REDUCED SPEED WINCHES XT40 - XT44 - XT48 - XT52 - XT62

Quick and powerful operation is obtainable with the first reduced speed, then with increasing load, simply wind in the opposite direction the second gear and maximum power is automatically selected.

#### TWO SPEED WINCHES

ITEM CODE	XT40/AL	XT44/AL	XT48/AL	XT52/AL	XT62/AL
ITEM CODE	XT40/CH	XT44/CH	XT48/CH	XT52/CH	XT62/CH
POWER P1-P2	12.8 / 40.0	20.0 / 43.0	19.0 / 47.4	15.9 / 52.8	17.8 / 62.1
RECOVERY S1-S2 (mm)	125 / 40	80 / 38	84 / 34	100 / 30	89 / 26
Ø LINE (mm)	6 / 12	8 / 14	8 / 14	8 / 14	8 / 16
WEIGHT AL (kg)	4.4	6.2	6.9	9.2	10.9
WEIGHT CH (kg)	5.9	8.7	9.9	13.0	15.7
SCREWS N x Ø (mm)	5 x Ø8	6 x Ø8	6 x Ø8	6 x Ø8	6 x Ø8

# self-tailing XT winches



XT66/AL

XT66/CH

## TWO REDUCED SPEED WINCHES XT66 - XT70

Large drum winches for 15-18 m boats. All the gears are fitted with roller bearings and the drum works on a very wide diameter roller-ball bearings.

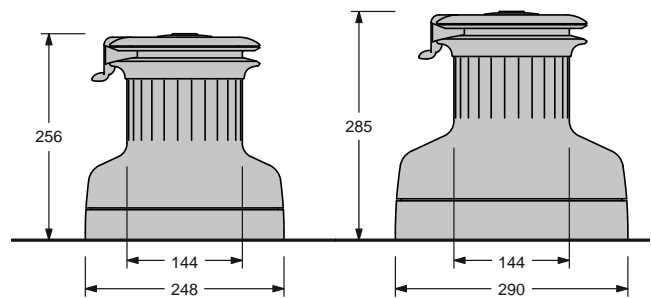

## TWO SPEED WINCHES

ITEM CODE	XT66/AL	XT70/AL
ITEM CODE	XT66/CH	XT70/CH
POWER P1-P2	18.0 / 65.6	27.1 / 69.8
RECOVERY S1-S2 (mm)	89 / 24	59 / 23
Ø LINE (mm)	10 / 18	10 / 18
WEIGHT AL (kg)	14.8	18.5
WEIGHT CH (kg)	24.6	30.0
SCREWS N x Ø (mm)	6 x Ø10	6 x Ø10

**antal**



XT70.3/AL

XT70.3/CH

## THREE REDUCED SPEED WINCHES XT62.3 - XT66.3 - XT70.3

The push-button on the base starts the first gear (the faster); second and third gear are automatically selected simply reversing the rotation of the handle.

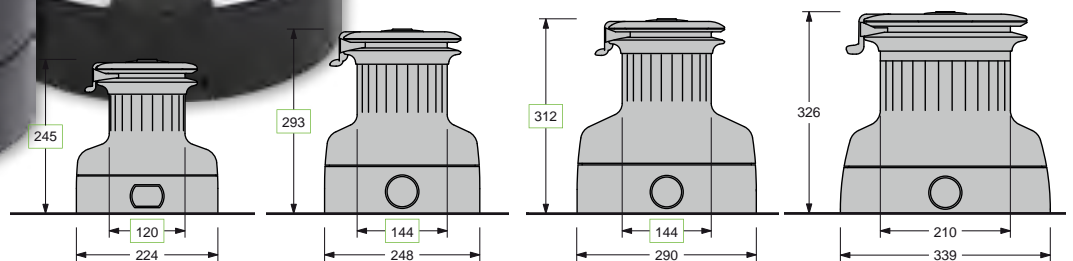

## THREE SPEED WINCHES

ITEM CODE	XT62.3/AL	XT66.3/AL	XT70.3/AL	XT80.3/AL
ITEM CODE	XT62.3/CH	XT66.3/CH	XT70.3/CH	XT80.3/CH
POWER P1-P2-P3	6.6 / 17.8 / 62.1	10.7 / 20.8 / 65.3	10.7 / 27.1 / 69.8	11.0 / 30.0 / 81.4
RECOVERY S1-S2-S3 (mm)	241 / 89 / 26	151 / 77 / 24	151 / 59 / 23	147 / 53 / 20
Ø LINE (mm)	8 / 16	10 / 18	10 / 18	12 / 20
WEIGHT AL (kg)	12.8	18.6	22.8	47.0
WEIGHT CH (kg)	17.6	28.4	34.4	52.0
SCREWS N x Ø (mm)	6 x Ø8	6 x Ø10	6 x Ø10	8 x Ø10

P1, P2, P3 : power with the first (fast), second (medium) and third (slow) gear.

S1, S2, S3 : recovery speed, the length of line recovered with one turn of the handle in first, second and third gear.

# classic winches

## *antal*



### CLASSIC SERIES WINCHES

Classic series winches (CHC) are supplied not only with a chromed drum, ST disks and ST arm, as the chrome series models (CH) described on pages 608-609, but also with a chromed lower skirt, thus being completely chromed.

The chrome-plating is carried out with great care to guarantee maximum durability. First the unit are highly polished, then thickly nickel-plated and finally finished in chrome.

### POLISHED BRONZE

On request, Antal classic winches can be supplied (with drum, ST disks, ST arm and skirt) entirely made of polished bronze (add /BNC after the winch model).



Natural bronze winch handle with wooden grip.

# electric winches 700 / 1000 W



## HORIZONTAL DRIVE - MOTOR 700 W 12/24 V XT40EH - XT44EH - XT48EH

The three models XT40, XT44 and XT48 are powered with a 700 Watt motor, available in 12 and 24 volt versions. Two switches, one control box and one breaker complete the system. These must be ordered separately.

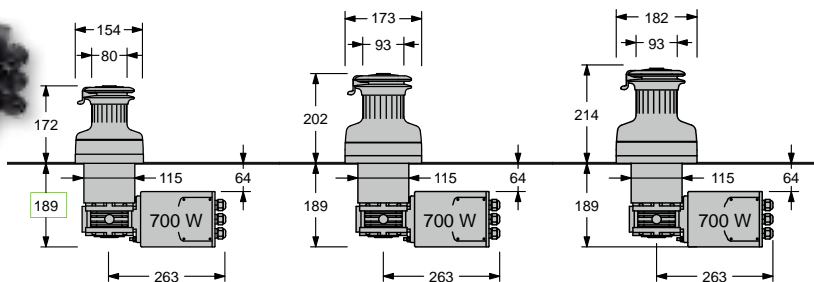

### TWO SPEED WINCHES

ITEM CODE (12V)	XT40EH12/AL	-	XT48EH12/AL
ITEM CODE (12V)	XT40EH12/CH	XT44EH12/CH	XT48EH12/CH
LINE SPEED 1 (m/min)	18.0	12.0	12.5
LINE SPEED 2 (m/min)	6.0	5.5	5.0
WORKING LOAD (kg)	800	900	1000
GLOBAL WEIGHT (kg) AL	16.2	18.2	19.1
GLOBAL WEIGHT (kg) CH	17.7	20.7	22.1



## HORIZONTAL DRIVE - MOTOR 1000 W 12/24 V XT52EH - XT62EH - XT62.3EH

Models XT52, XT62 and XT62.3 are powered with a 1000 Watt, 12 or 24 Volt motor. Two switches, one control box and one breaker complete the system. These must be ordered separately.

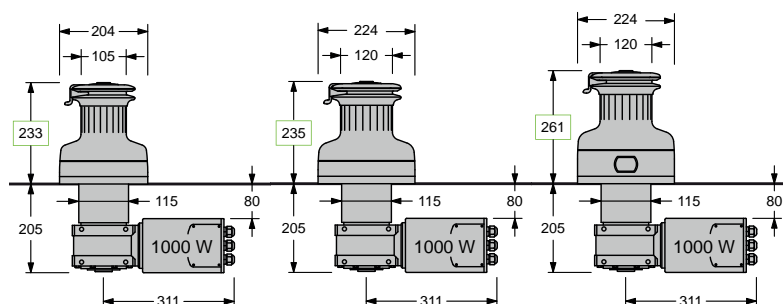

### TWO- OR THREE-SPEED WINCHES

ITEM CODE (12V)	XT52EH12/AL	XT62EH12/AL	XT62.3EH12/AL
ITEM CODE (12V)	XT52EH12/CH	XT62EH12/CH	XT62.3EH12/CH
LINE SPEED 1 (m/min)	16.0	13.0	36.9
LINE SPEED 2 (m/min)	4.6	4.0	13.0
LINE SPEED 3 (m/min)	- - -	- - -	4.0
WORKING LOAD (kg)	1200	1400	1400
GLOBAL WEIGHT (kg) AL	26.3	28.3	30.2
GLOBAL WEIGHT (kg) CH	30.1	33.1	35.0

LINE SPEED: the recovery speed is calculated with the winch not under load; at maximum load the figure should be reduced by 30%.

MANUAL USE: the gearbox-motor unit is disengaged simply by inserting the handle.

After the model specify the required voltage (12 or 24 V).

# electric winches 1500 W

## HORIZONTAL DRIVE - MOTOR 1500 W 12/24 V XT66EH - XT70EH

Models XT66 and XT70 are powered with a 1500 Watt, 12 or 24 Volt motor. Two switches, one control box and one breaker complete the system. These must be ordered separately.

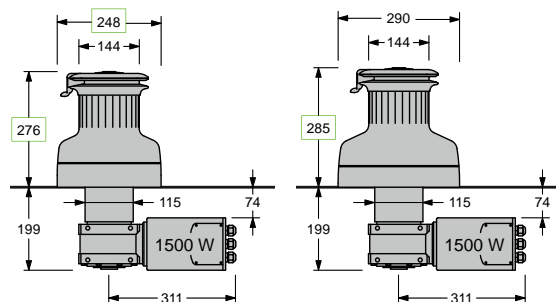

### TWO SPEED WINCHES

ITEM CODE (12V)	XT66EH12/AL	XT70EH12/AL
ITEM CODE (12V)	XT66EH12/CH	XT70EH12/CH
LINE SPEED 1 (m/min)	13.0	9.0
LINE SPEED 2 (m/min)	3.6	3.5
WORKING LOAD (kg)	2600	2900
GLOBAL WEIGHT (kg) AL	31.9	35.9
GLOBAL WEIGHT (kg) CH	41.7	47.4

**antal**

## HORIZONTAL DRIVE - MOTOR 1500 W 12/24 V XT66.3EH - XT70.3EH - XT80.3EH

These models maintain three speeds both in manual and in electric use; the push-button on the base starts the first gear, second and third gear are automatically selected by simply reversing the rotation of the handle or pressing one of the two switches, one for the first and the third speed and one for the second.

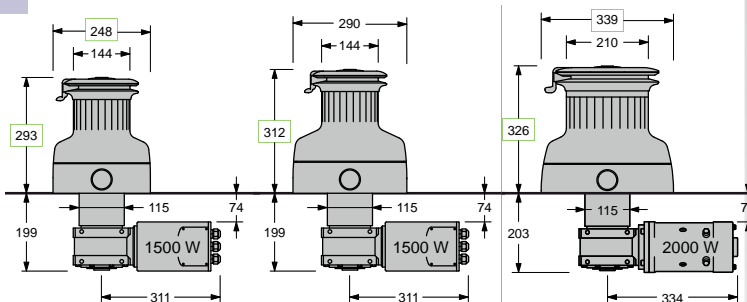

### THREE SPEED WINCHES

ITEM CODE (12V)	XT66.3EH12/AL	XT70.3EH12/AL	XT80.3EH12/AL
ITEM CODE (12V)	XT66.3EH12/CH	XT70.3EH12/CH	XT80.3EH12/CH
LINE SPEED 1 (m/min)	23.0	23.0	22.0
LINE SPEED 2 (m/min)	12.0	9.0	8.0
LINE SPEED 3 (m/min)	3.6	3.5	3.0
WORKING LOAD (kg)	2600	2900	4000
GLOBAL WEIGHT (kg) AL	35.7	40.3	59.6
GLOBAL WEIGHT (kg) CH	45.5	51.8	75.0

XT70.3 EH/CH  
1500 W 12-24 V



XT70.3 EH/AL  
1500 W 12-24 V





**NEW**

**Switches**

**Watertight Switches**

**Item Code 251035/SG** Switch stainless steel, grey

**Item Code 251035/SR** Switch stainless steel, red

**Item Code 251035/AG** Switch aluminum, grey

**Item Code 251035/AR** Switch aluminum, red

For solenoid boxes (3-pole for Antal winches): see p. 231



**Automatic Fuses**

**Automatic Thermo-Magnetic Fuses**

Motor	Fuse	Code	Motor	Fuse	Code
700W-12V	70A	<b>085592</b>	1500W-12V	120A	<b>085595</b>
700W-24V	40A	<b>085590</b>	1500W-24V	70A	<b>085592</b>
1000W-12V	80A	<b>085593</b>	2000W-24V	80A	<b>085593</b>
1000W-24V	70A	<b>085592</b>			

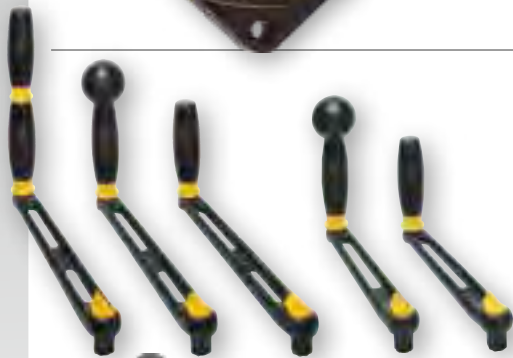

**Winch Handles Aluminum**

Black aluminum handles of great strength and extreme low weight. Rubber grip with ball bearings. Easy locking

Item Code	Grip	Length	Weight
<b>542011</b>	Single	200mm	400g
<b>542012</b>	Ball Grip	200mm	460g
<b>542021</b>	Single	250mm	430g
<b>542022</b>	Ball Grip	250mm	490g
<b>542023</b>	Double	250mm	540g



**Winch Handles Chromed Bronze**

Chromed bronze handles of great strength  
Rubber grip with ball bearings. Easy locking

Item Code	Grip	Length	Weight
<b>542031</b>	Single	250mm	1400g
<b>542032</b>	Ball Grip	250mm	1460g
<b>542033</b>	Double	250mm	1530g



**Winch Handles Natural Bronze**

**Polished Bronze Winch Handle with Single Plastic Grip and Lock**

**Item Code 542031/BG** L=250mm, Weight = 1400g



**Floating Winch Handle**

**Item Code M2500025**

Floating winch handle of light but strong plastic, with lock.  
L=254mm

# speedylock

## THE SPEEDY WAY TO LOCK-UNLOCK THE WINCH HANDLE

Speedylock is the new Antal winch handle, available with the 250 mm lever with single, ball and double grip.

Hard black anodized forged aluminium lever, rubber grip on two ball bearings (on singlegrip and ball-grip version).

### ALUMINUM L = 250 mm

ITEM CODE	Hand Grip	Weight (kg)
542121	Single	0.43
542122	ball-grip	0.53
542123	Double	0.62

## antal

542121



542122



542123



# antal



## Traveller Control System



The control system is connected to a traveller on a closed circuit and ensures efficient control and a clean layout.

The system uses a self tailing pulley which operates in both direction with a textile "gripping" system that is efficient even if the circuit is not under strain and causes no wear in the rope. A clutch pin sets the direction in which the traveller moves, or allows for it to be locked in the required position.

The power ratio obtainable with a normal (250mm) handle is 8 to 1, which is much better than a tackle can offer; moreover, this system has a very limited size and weight.

- Material: it is made of hard black anodized aluminum, central rod and ball bearing of 316 stainless steel
- Dimensions: 128x90x58mm (lxwxh)
- Weight: 1,9kg
- Screws: 3x Ø8mm

### Item Code 240010

A 10mm line is strongly recommended

**Now also electrically powered version available!**





## Rope Clutches

# CAM 611

### Rope Clutches CAM 611

A model for line 6 to 11mm is available in single, double and triple, as well as horizontal.

CAM 611 has a box structure in UV-resistant resin with steel reinforcements, an extruded aluminum base, wear-resistant bronze cam mechanism, and stainless steel aligning bushing.

The clutch can be completely dismantled for simple maintenance.

Line retrieval can be achieved with the lever closed, and the cam mechanism guarantees easy opening even under heavy load.

### Rope Clutches



CAM 611 Clutches (Rope Ø6-10mm)				Max. Load kg		
Code	Type	Width	Weight	Ø6mm	Ø8mm	Ø10mm
513110	Single	33mm	0.30kg	250kg	380kg	500kg
513120	Double	62mm	0.60kg	250kg	380kg	500kg
513130	Triple	91mm	0.90kg	250kg	380kg	500kg
513210	Single/Horiz.	33mm	0.33kg	400kg	600kg	-----

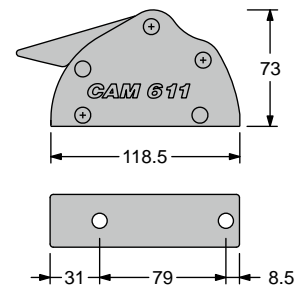

# antal

This solution has been designed for the new double and triple CAM 611: mounted at the back of the clutch battery guiding the line towards the winch.

### Item Code 522031

Screws: 2 x Ø8mm

Weight: 0.16kg



A set of 54 stickers is provided for an easy indication of manoeuvres (English); colors: red, green and black.

### Item Code 540513/E

### Double Sheave Organizer

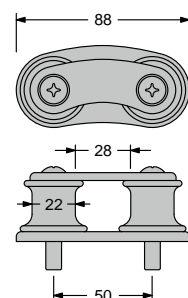
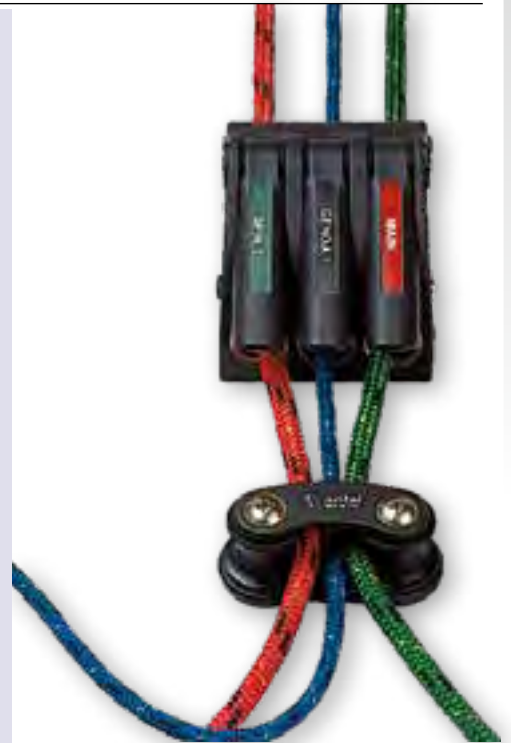

**CLUTCHES**



**Clutches V-GRIP**

**CLUTCHES V-GRIP**

Aisi 316 s.steel mechanism and lever, bronze "V" shaped cam and black anodized aluminum structure.  
3 models are available for 8-12, 10-14, and 12-16mm. lines in single, double and triple version.  
This is the best solution when minimum sizes are required: it is only 66mm high.

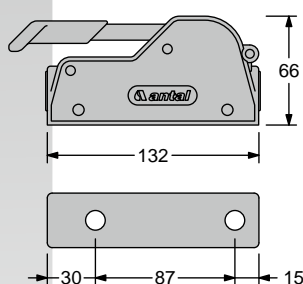

V-Grip Clutches					Max. Load kg				
Code	Type	Ø Rope	Width	Weight	Ø8mm	Ø10mm	Ø12mm	Ø14mm	Ø16mm
507111	Single	8-10-12	34mm	0.55kg	500kg	700kg	1000kg	--	--
507121	Double	8-10-12	67mm	1.10kg	500kg	700kg	1000kg	--	--
507131	Triple	8-10-12	101mm	1.45kg	500kg	700kg	1000kg	--	--
507112	Single	10-12-14	34mm	0.55kg	--	700kg	1000kg	1300kg	--
507122	Double	10-12-14	67mm	1.10kg	--	700kg	1000kg	1300kg	--
507132	Triple	10-12-14	101mm	1.45kg	--	700kg	1000kg	1300kg	--
507113	Single	12-14-16	34mm	0.55kg	--	--	1000kg	1300kg	1600kg



**V-GRIP CLUTCH ORGANIZER**

This solution allows manoeuvres to be guided from the clutches to the winch.  
Resin sheave with double ball bearing and black aluminum cover, screws are included.

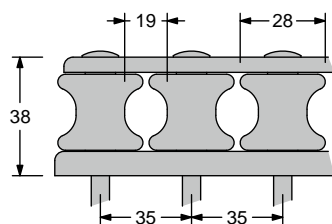

**V-GRIP Clutch Organizer**

Item Code	Sheaves No.	Length mm	Weight kg	Screws No. x Ømm
533032	3	100	0,19	3 x 6
534032	4	135	0,24	4 x 6
535032	5	170	0,30	5 x 6
536032	6	205	0,35	6 x 6

**antal**

**CLUTCHES V-CAM814**

Three models for 8-10mm., 10-12mm. and 12-14mm. lines; available in single, double, triple and quadruple.

V-CAM814 has a box-structure in UV-resistant resin with s.steel reinforcements, aluminum base, V-Cam and aligning bushing in Aisi 316.

It can be completely dismantled for simple maintenance and repairing.

Line retrieval can be achieved with the lever closed.

This model is fitted with a large "V" shaped cam that offers higher holding strength than model V-Grip and a new mechanism that guarantees easy opening even under heavy load.

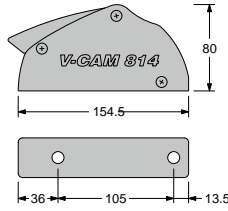

**V-CAM 814 Clutches**



V-CAM 814 Clutches					Max. Load kg			
Code	Type	Ø Rope	Width	Weight	Ø8mm	Ø10mm	Ø12mm	Ø14mm
509111	Single	8-10	36mm	0.60kg	600kg	850kg	1200kg	--
509121	Double	8-10	65mm	1.10kg	600kg	850kg	1200kg	--
509131	Triple	8-10	94mm	1.45kg	600kg	850kg	1200kg	--
509112	Single	10-12	36mm	0.60kg	--	850kg	1200kg	--
509122	Double	10-12	65mm	1.10kg	--	850kg	1200kg	--
509132	Triple	10-12	94mm	1.60kg	--	850kg	1200kg	--
V-CAM 814 SILVER Clutches					Max. Load kg			
Code	Type	Ø Rope	Width	Weight	Ø8mm	Ø10mm	Ø12mm	Ø14mm
549121	Double	8-10	65mm	1.10kg	600kg	850kg	--	--
549122	Double	10-12	65mm	1.10kg	--	850kg	1200kg	--
549123	Double	12-14	65mm	1.10kg	--	--	1200kg	1500kg
549131	Triple	8-10	94mm	1.60kg	600kg	850kg	--	--
549132	Triple	10-12	94mm	1.60kg	--	850kg	1200kg	--
549133	Triple	12-14	94mm	1.60kg	--	--	1000kg	1500kg

**V-CAM 814 CLUTCH ORGANIZER**

This solution allows manoeuvres to be guided from the clutches to the winch. Resin sheave with double ball bearing and black aluminum cover, screws are included.

Item Code	Sheaves No.	Length mm	Weight kg	Screws No. x Ømm
513032	3	110	0.18	3 x 6
514032	4	139	0.22	4 x 6
515032	5	168	0.27	5 x 6
516032	6	197	0.32	6 x 6



**V-CAM 814 Clutch Organizer**

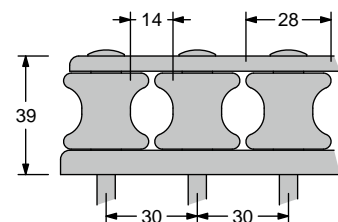

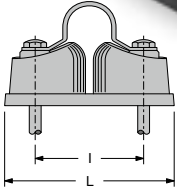

### Servo Cleat

#### Servo cleat

The particular stainless and plastic cam teeth conformation is designed to make line inserting between cams easy. Made of plastic with s. steel "ribs". Screws are included.

Item Code	ØLine	I	L	Screws
502022	6-12	40	70	2 x 5 (mm)
502033	10-14	52	86	2 x 6 (mm)

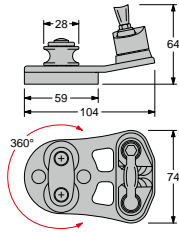

### Swivelling Cleat

#### Swivelling cleat

The aluminum base swivels through 360° on single races of Torlon ball bearings.

The system is fitted with 2 x 28mm. sheaves for lines up to 10mm.

Fixing: 3 x 5mm screws

Weight: 0.23kg

**SWL on the cam cleat: 150kg**

**Item Code 522022**

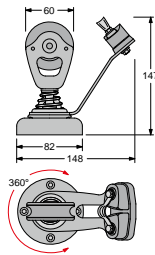

### Block and Servo Cleat

#### Block and servo cleat

The aluminum base swivels through 360° on double races of Torlon ball bearings.

The system is completed with a 60mm block for lines up to 12mm.

Fixing: 3 x Ø6mm screws

Weight: 0.82kg

**SWL on the cam cleat: 200kg**

**Item Code 522140**

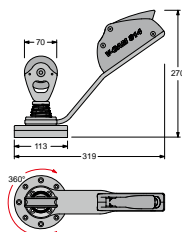

### Block and V-CAM 814

#### Block and v-cam 814

The aluminum base swivels through 360° on double races of Torlon ball bearings.

The system is completed with a 70mm block for lines up to 12mm and a V-CAM814 clutch.

Fixing: 4 x Ø8mm screws (not included)

Weight: 2.10kg

**SWL on the clutch: 400kg**

**Item Code 522160**

**antal**

### Stopper Deck Block

The sheaves are made of high strength resin, fitted with composite fibre bush and side ball-bearings. No maintenance or lubrication is required.

The machined side plates are made of high strength alloy, hard black anodized for wear and corrosion proofing and with all the edges smoothed off.

The aluminum locking cam is fitted on an automatic opening spring: relaxing the sheet is sufficient to open the jammer. Compact design with the lever fully concealed within the side plates and with recessed fasteners. The cam cannot be locked under high loads. It's intended to hold the line temporarily and not under heavy loads.

Left and right versions are available.

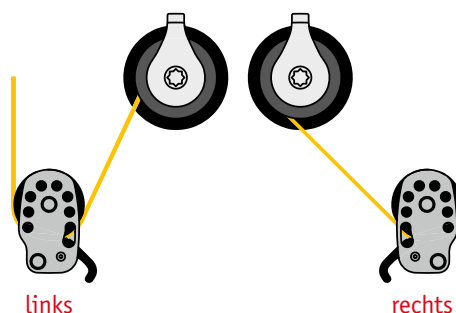

851100/L

### Stopper Deck Block



852100/L

#### STOPPER DECK BLOCKS-LEFT

Item Code	Line Ømm	D mm	L mm	SWL kg	Weight kg	Screws N° x Ø mm
<b>Single</b>						
851065/L*	6 -12	65	116	800	0.23	2 x 8
851080/L	6 -14	80	131	1000	0.33	2 x 8
851100/L	8 -16	100	152	2000	0.65	2 x 10
851125/L	10 - 18	125	174	3500	1.10	1 x 12 + 2 x 10

#### Double

852065/L*	6 - 12	65	116	800	0.38	2 x 8
852080/L	6 - 14	80	131	1000	0.56	2 x 8
852100/L	8 - 16	100	152	2000	1.50	2 x 10
852125/L	10 - 18	125	174	3500	1.85	1 x 12 + 2 x 10

#### STOPPER DECK BLOCKS-RIGHT

Item Code	Line Ømm	D mm	L mm	SWL kg	Weight kg	Screws N° x Ø mm
<b>Single</b>						
851065/R*	6 -12	65	116	800	0.23	2 x 8
851080/R	6 -14	80	131	1000	0.33	2 x 8
851100/R	8 -16	100	152	2000	0.65	2 x 10
851125/R	10 - 18	125	174	3500	1.10	1 x 12 + 2 x 10

#### Double

852065/R*	6 - 12	65	116	800	0.38	2 x 8
852080/R	6 - 14	80	131	1000	0.56	2 x 8
852100/R	8 - 16	100	152	2000	1.50	2 x 10
852125/R	10 - 18	125	174	3500	1.85	1 x 12 + 2 x 10

\* In the smallest model (D=65mm) there is no spring for the cam opening

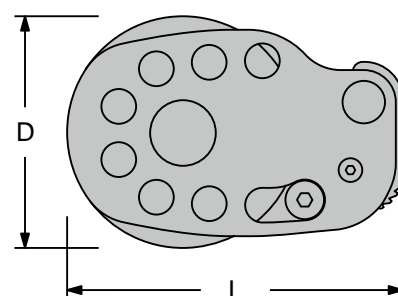



### Stainless Steel Mini Blocks

#### STAINLESS STEEL MINI BLOCKS 34x6 SERIES

This series offers extremely high working loads (SWL = 400kg) while still compact and lightweight. The sheave is made of resin with a double lateral ball-bearing. Cheekplates are made of perfectly polished AISI 316 stainless steel. The high quality materials guarantee a maintenance-free product.

#### Item Code 5403411/M

Resin sheave with double self-captive ball bearings.  
Diameter = 34mm for 6mm lines.  
**SWL = 400kg**



#### CAM CLEAT

All models can be supplied with cam cleat. Just add "/C" to the item code when ordering.  
Weight = +42g  
**Max load = 80kg**



#### SWIVEL HEAD

All models are available with swivel head, just add "/SW" to the item code when ordering.  
Weight = +15g  
**Max load = 400kg**



**Item Code 5400323**  
Upright Block  
Weight = 55g  
**SWL = 400kg**  
34mm sheave for 8mm line  
2 x Ø5mm screws (included)



**Item Code 5400324**  
"Over the Top" Block  
Weight = 65g  
**SWL = 400kg**  
34mm sheave for 8mm line  
2 x Ø5mm screws (included)



More vertical blocks can be joined to form a set  
**Mod. 5400323/2, 5400323/3, 5400323/4 ...**  
**Mod. 5400324/2, 5400324/3, 5400324/4 ...**



**Item Code 5400301**  
Shackle Block  
Weight = 44g  
SWL = 400kg



**Item Code 5400320**  
Single U-head  
Weight = 40g  
SWL = 400kg



**Item Code 5400309**  
Webbing Block  
Weight = 35g  
SWL = 400kg



**Item Code 5400302**  
Single Becket  
Weight = 52g  
SWL = 400kg



**Item Code 5400321**  
U-head Becket  
Weight = 43g  
SWL = 400kg



**Item Code 5400310**  
Webbing Becket  
Weight = 43g  
SWL = 400kg



**Item Code 5400330**  
Fiddle Block  
Weight = 65g  
SWL = 400kg



**Item Code 5400303**  
Double Block  
Weight = 82g  
SWL = 600kg



**Item Code 5400304**  
Double Becket  
Weight = 90g  
SWL = 600kg



**Item Code 5400331**  
Fiddle Becket  
Weight = 76g  
SWL = 400kg



**Item Code 5400305**  
Triple Block  
Weight = 94g  
SWL = 600kg



**Item Code 5400306**  
Triple Becket  
Weight = 102g  
SWL = 600kg



**Item Code 5400322**  
Saddle Block  
Weight = 46g  
SWL = 400kg  
2 x Ø5mm screws  
(included)

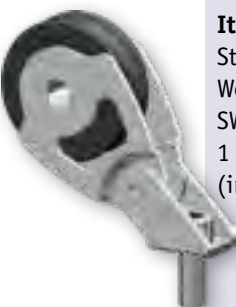

**Item Code 5400316**  
Stand-Up  
Weight = 46g  
SWL = 400kg  
1 x Ø6mm screw  
(included)



**Item Code 5400311**  
Foot Block  
Weight = 36g  
SWL = 400kg  
2 x Ø6mm screws  
(included)

## OPF Blocks

### The ONE PIECE FRAME

The one-piece aluminum extruded body is the strongest and lightest solution, no assembling pin rivets or screws and nuts.

CNC machined - polished - hard black anodized and teflon coated.

### The COMPOSITE FIBRE sheave

The resin (aluminum on larger models) sheave runs on the main Composite Fibre bearing and on a ground s.steel hub: low friction highloads - no lubricant required.

The self-captive side ball bearing reduces the friction and makes disassembling, cleaning and maintenance very easy.

## Complete mainsheet systems

These systems are particularly suitable for the mainsheet control.

They are all fitted with:

- 2 OPF blocks (sheaves Ø60 or 70mm) to connect to the boom;
- 1 main block (sheave Ø75mm) with "camcleat" and swivel coupling to the main car;
- 1 double or triple swivelling OPF block, with 65mm diameter sheave with swivel coupling to the main block.

All sheaves are made of HRM resin with 2 races of ball bearings for lines up to 11mm.

On these systems the double and triple 65mm blocks are supplied with a special stronger swivelling head.

For boats up to 40'



## Complete Mainsheet Systems

For boats up to 40'



### Item Code E.6

Power = 6:1

SWL = 1000kg

Breaking Load = 2000kg



### Item Code E.7

Power = 7:1

SWL = 1000kg

Breaking Load = 2000kg



### Item Code E.8

Power = 8:1

SWL = 1500kg

Breaking Load = 3000kg

# antal



**Two speed mainsheet tackle: 4/8 and 16/8**

The particular configuration adopted permits the use of large diameter sheaves which improve performance of the system; it also ensures maximum block orientation capabilities and therefore the possibility to operate on both sides of the boat. Furthermore, this reduces the necessary sheet length. The two speeds are controlled by means of two independent lines. Main sheaves (Ø65mm) are made of HRM resin and fitted with a double ball bearing. For rope Ø12mm (not included).

**Two Speed  
Mainsheet  
Tackle**

For boats up to 36'



**8:1**

**4:1**

**Item Code F.4**

2 speed system

1° ratio = 4:1 (rapid recovery)

2° ratio = 8:1 (fine adjustment)

**SWL = 1000kg**

Breaking Load = 2000kg

For boats up to 40'

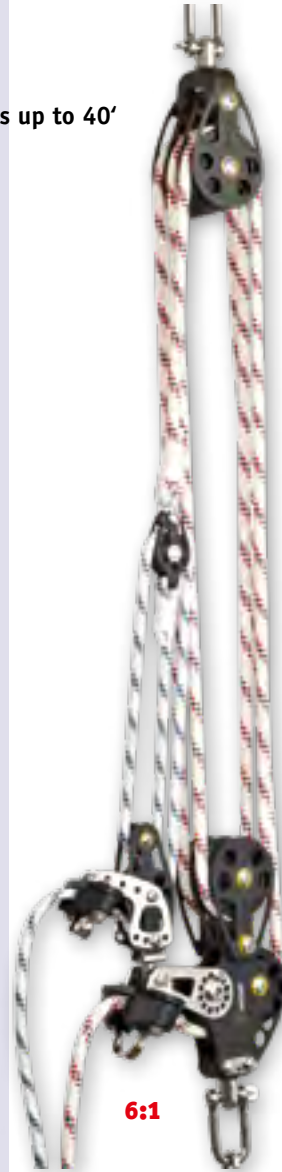

**18:1**

**6:1**

**Item Code F.6**

2 speed system

1° ratio = 6:1 (rapid recovery)

2° ratio = 18:1 (fine adjustment)

**SWL = 1500kg**

Breaking Load = 3000kg

**antal**



**antal**

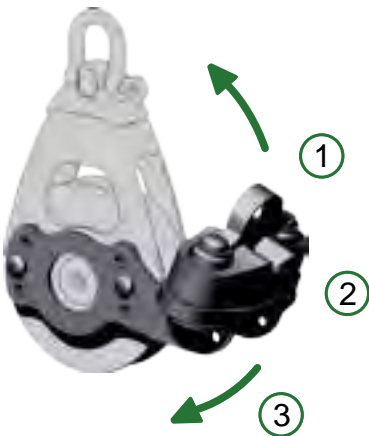

**Lock**

**Item Code 5400620**

single lock

**Item Code 5400620/2**

double lock

**Item Code 5400620/3**

triple lock

**Block complete with CamCleat**

for blocks with cleat add "/C" to the block item code. With 3 different positions for single, double and triple. Weight = 0.13kg  
**SWL = 150kg**

**OPF blocks 60**

60mm sheave for 12mm line  
 SWL = 800kg



**Item Code 5400601**  
 Swivel Block  
 Weight\* = 0.16kg  
 6mm shackle  
**SWL = 800kg**



**Item Code 5400602**  
 Becket Block  
 Weight\* = 0.18kg  
 6mm shackle  
**SWL = 800kg**

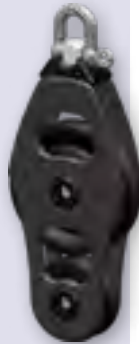

**Item Code 5400607**  
 Single Fiddle  
 Weight\* = 0.21kg  
 6mm shackle  
**SWL = 800kg**



**Item Code 5400608**  
 Becket Fiddle  
 Weight\* = 0.23kg  
 6mm shackle  
**SWL = 800kg**



**Item Code 5400603**  
 Double Sheave  
 Weight\* = 0.31kg  
 8mm shackle  
**SWL = 1300kg**



**Item Code 5400604**  
 Double Becket  
 Weight\* = 0.33kg  
 8mm shackle  
**SWL = 1300kg**



**Item Code 5400605**  
 Triple Sheave  
 Weight\* = 0.41kg  
 8mm shackle  
**SWL = 1300kg**



**Item Code 5400606**  
 Triple Becket  
 Weight\* = 0.43kg  
 8mm shackle  
**SWL = 1300kg**



**Item Code 5400609**  
 Simple Web  
 Weight = 0.10kg  
 For line connection  
**SWL = 800kg**

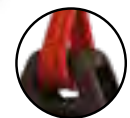

**Item Code 5400610**  
 Web Becket  
 Weight = 0.12kg  
 For line connection  
**SWL = 800kg**



**Item Code 5400613**  
BLOCK U-BOLT  
Weight = 0.22kg  
2x Ø6mm screws  
SWL = 800kg



**Item Code 5400614**  
BLOCK PAD-EYE  
Weight = 0.26kg  
4x Ø6mm screws  
SWL = 800kg



**Item Code 5400615**  
BLOCK SCREWED  
Weight = 0.39kg  
4x Ø6mm screws  
SWL = 800kg



**Item Code 547106**



**Item Code 547206**



**Item Code 547306**



**Item Code 5400611**  
Foot Block  
Weight = 0.13kg  
2 x Ø6mm screws  
SWL = 800kg



**Item Code 5400612**  
Double Foot  
Weight = 0.22kg  
3 x Ø6mm screws  
SWL = 800kg



**Item Code 5400616**  
Vertical Fix  
Weight = 0.14kg  
2 x Ø6mm screws  
SWL = 800kg



**Item Code 5400617**  
Up-Down  
Weight = 0.15kg  
2 x Ø6mm screws  
SWL = 800kg



**antal**

**opf BLOCKS**  
one piece frame

Swivel head locks and shackles are always included, but they are available separately.



**Item Code 540061L**  
Longitudinal or  
transversal head  
lock for single blocks



**Item Code 540082L**  
Longitudinal or  
transversal head  
lock for double  
and triple blocks



**Item Code 540065S**  
6mm shackle (Aisi 316)  
For single blocks  
SWL = 800kg  
Weight = 26g



**Item Code 540085S**  
8mm shackle (Aisi 316)  
For double and triple blocks  
SWL = 1300kg  
Weight = 62g



**antal**

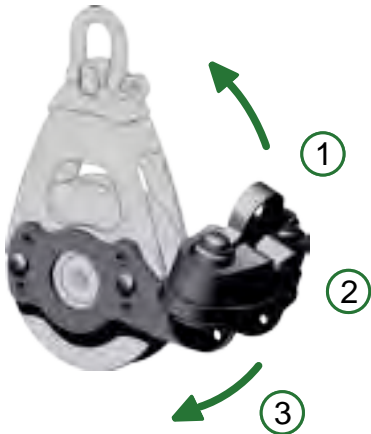

**Lock**

- Item Code 5400720**  
single lock
- Item Code 5400720/2**  
double lock
- Item Code 5400720/3**  
triple lock

**Block complete with CamCleet**  
for blocks with cleat add "/C" to  
the block item code. With 3 different  
positions for single, double and  
triple. Weight = 0.13kg  
**SWL = 150kg**

**OPF blocks 70**

70mm sheave for 12mm line  
SWL = 1300kg or 2200kg



**Item Code**  
**5400701**  
Swivel Block  
Weight\* = 0.20kg  
6mm HR shackle  
**SWL = 1300kg**



**Item Code**  
**5400702**  
Becket Block  
Weight\* = 0.22kg  
6mm HR shackle  
**SWL = 1300kg**

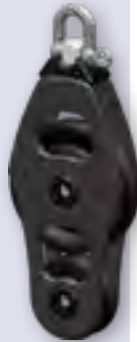

**Item Code**  
**5400707**  
Single Fiddle  
Weight\* = 0.26kg  
6mm HR shackle  
**SWL = 1300kg**



**Item Code**  
**5400708**  
Becket Fiddle  
Weight\* = 0.28kg  
6mm HR shackle  
**SWL = 1300kg**



**Item Code**  
**5400703**  
Double Sheave  
Weight\* = 0.38kg  
8mm HR shackle  
**SWL = 2200kg**



**Item Code**  
**5400704**  
Double Becket  
Weight\* = 0.40kg  
8mm HR shackle  
**SWL = 2200kg**



**Item Code**  
**5400705**  
Triple Sheave  
Weight\* = 0.50kg  
8mm HR shackle  
**SWL = 2200kg**



**Item Code**  
**5400706**  
Triple Becket  
Weight\* = 0.52kg  
8mm HR shackle  
**SWL = 2200kg**

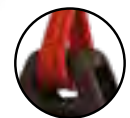

**Item Code**  
**5400709**  
Simple Web  
Weight = 0.14kg  
For line connection  
**SWL = 1300kg**



**Item Code**  
**5400710**  
Web Becket  
Weight = 0.16kg  
For line connection  
**SWL = 1300kg**



**Item Code 5400713**  
BLOCK U-BOLT  
Weight = 0.32kg  
2x Ø8mm screws  
SWL = 1300kg



**Item Code 547108**



**Item Code 5400714**  
BLOCK PAD-EYE  
Weight = 0.41kg  
4x Ø8mm screws  
SWL = 1300kg



**Item Code 547208**



**Item Code 5400715**  
BLOCK SCREWED  
Weight = 0.75kg  
4x Ø6mm screws  
SWL = 1300kg



**Item Code 547308**



**Item Code 5400711**  
Foot Block  
Weight = 0.16kg  
2 x Ø8mm screws  
SWL = 1300kg



**Item Code 5400712**  
Double Foot  
Weight = 0.26kg  
3 x Ø8mm screws  
SWL = 1300kg



**Item Code 5400716**  
Vertical Fix  
Weight = 0.18kg  
2 x Ø8mm screws  
SWL = 1300kg

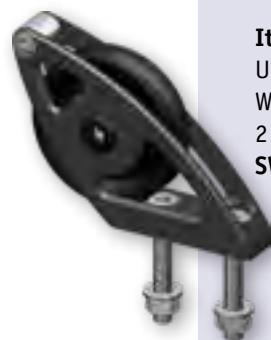

**Item Code 5400717**  
Up-Down  
Weight = 0.20kg  
2 x Ø8mm screws  
SWL = 1300kg



**antal**

**opf BLOCKS**  
one piece frame

Swivel head locks and shackles are always included, but they are available separately.



**Item Code 540061L**  
Longitudinal or transversal head lock for single blocks



**Item Code 540082L**  
Longitudinal or transversal head lock for double and triple blocks



**Item Code 540065S**  
6mm shackle (Aisi 316)  
For single blocks  
SWL = 800kg  
Weight = 26g



**Item Code 540085S**  
8mm shackle (Aisi 316)  
For double and triple blocks  
SWL = 1300kg  
Weight = 62g



**antal**

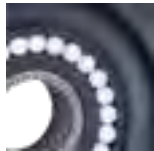

**Lock**

**Item Code 54S0620**

single lock

**Item Code 54S0620/2**

double lock

**Item Code 54S0620/3**

triple lock

**Block complete with CamCleat**

All models are available with

cam-cleat, add "/C" to the block item code.

4 Positions.

Weight = + 0.18kg

**Max load = 160kg**



**Item Code**

**54S0613**

Block on U-bolt

Weight = 0.36kg

2 x Ø6mm screws

**SWL = 800kg**



**Item Code**

**54S0614**

Block on Pad-eye

Weight = 0.38kg

2 x Ø6mm screws

**SWL = 800kg**



**Item Code**

**54S0615**

Block on Screwed

Pad-eye

Weight = 0.45kg

2x Ø6mm screws

**SWL = 800kg**



**Item Code**

**54S0611**

**Deck Block**

Weight = 0.30kg

2 x Ø8mm screws

**SWL = 800kg**



**Item Code**

**54S0612**

**Double Deck Block**

Weight = 0.46kg

2 x Ø8mm screws

**SWL = 800kg**



**Item Code**

**54S0616**

**Stand-Up Block**

Weight = 0.37kg

1xØ12mm screw

**SWL = 800kg**

**Stainless Steel Blocks 65**

65mm sheave for 12mm line Safe Working Load = 800kg or 1300kg



**Item Code**

**54S0601**

Single Block

Weight = 0.29kg

Swivel head for

6mm shackle\*

**SWL = 800kg**



**Item Code 54S0602**

Single with Becket

Weight = 0.32kg

Swivel head for

6mm shackle\*

**SWL = 800kg**



**Item Code**

**54S0603**

Double Block

Weight = 0.51kg

Fixed head for

8mm shackle\*

**SWL = 1200kg**



**Item Code**

**54S0604**

Double with Becket

Weight = 0.54kg

Fixed head for

8mm shackle\*

**SWL = 1200kg**



**Item Code**

**54S0605**

Triple Block

Weight = 0.70kg

Fixed head for

8mm shackle\*

**SWL = 1200kg**



**Item Code**

**54S0606**

Triple with Becket

Weight = 0.73kg

Fixed head for

8mm shackle\*

**SWL = 1200kg**



**Item Code**

**54S0609**

Web Block

Weight = 0.25kg

For line connection

**SWL = 800kg**

**Organizers D=40 AND 50mm**

Groups of 2 to 6 sheaves in 2 diameters of 40 and 50mm. The sheaves are manufactured in high-strength resin with a double side ball bearing.

Mounting screws, nuts and washers are included. These new organizers do not disassemble after tacking off the screws.

Double version also available, just add „/D“ to the model number.

**Organizers**



Item Code 54D550

Item Code 54D540

Item Code 54D530

Item Code	D mm	Line mm	Sheaves No.	Length mm	P mm	Weight kg	SWL kg	Bolts No. x Ømm
54D420	40	Ø14	2	111	44	0.18	600	3 x Ø6
54D430	40	Ø14	3	155	44	0.27	600	4 x Ø6
54D440	40	Ø14	4	199	44	0.33	600	5 x Ø6
54D450	40	Ø14	5	243	44	0.41	600	6 x Ø6
54D460	40	Ø14	6	287	44	0.48	600	7 x Ø6
54D520	50	Ø16	2	133	52	0.26	800	3 x Ø8
54D530	50	Ø16	3	185	52	0.38	800	4 x Ø8
54D540	50	Ø16	4	237	52	0.50	800	5 x Ø8
54D550	50	Ø16	5	289	52	0.62	800	6 x Ø8
54D560	50	Ø16	6	341	52	0.74	800	7 x Ø8

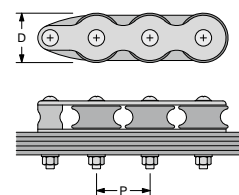

**Turning sheave**

Mounted aft of a set of rope clutches, the turning sheave redirects each line to the most suitable winch.

Item Code	D mm	H mm	SWL kg	Weight kg	Bolts No. x Ømm
821052	50	33	800	0.10	1 x 10
821062	60	38	1200	0.12	1 x 12
821074	70	44	1800	0.45	4 x 8

**Turning Sheave**

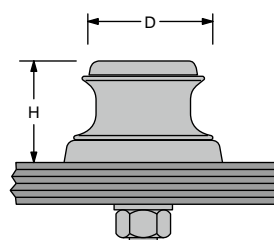



**THB**  
TWIN HALYARD BLOCKS

**Twin Halyard Blocks**

The Twin-fall block is specially made for 2:1 delayed mainsail traps. The very small aluminum disc is mounted with a "Composite Fiber" bus. The frame is complete made of (high-resistance) stainless steel "Nitronic 50". Available in 3 sizes with breaking forces up to 7000kg.

**Twin Halyard Blocks**

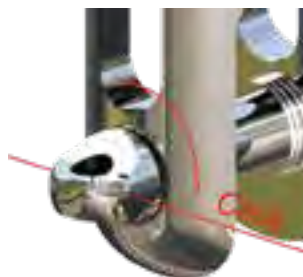

Self-locking pin



Captive pin

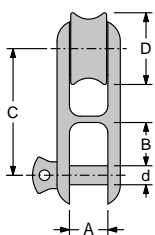

Item Code	Ø Line mm	D mm	d mm	A mm	B mm	C mm	SWL kg	Weight kg
54H020	8-10	26	8	16	15.5	53.5	1300	0.08
54H030	10-12	32	10	18	20.5	65.0	2200	0.15
54H040	12-14	39	12	21	24.5	80.0	3500	0.28



**HLB**  
HIGH LOAD BLOCKS

**High Load Blocks**

These blocks are suitable for very high loads at minimum dimensions. The very small disc is mounted on a "Composite Fiber" bushing. The frame is made of one piece manufactured (OPF) and is intended to be attached with line or strap.

The three blocks (D = 30, 40 and 55mm) are intended for an 8:1 system. This one is specially designed for the backstay or as boom hold-down.

**High load Blocks**

Item Code	Ø Line mm	D mm	H mm	SWL kg	Weight kg
54H130	6-10	30	59	600	0.05
54H140	8-10	40	74	1200	0.08
54H150	10-12	55	91	2400	0.18
54H160	14-16	70	116	3500	0.33

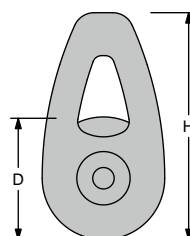

High-load System 8:1



**Mini snatch block D=32mm**

It is a very light solution suitable for many riggings, completely made in U-V resistant high strength resin. It can be fastened both with a line or with a shackle.

Sheave Ø 32mm. weight 39g, max. line Ø 8mm, SWL - 250kg



Black  
549030

Yellow  
549030/Y

**Snap loop**

Item Code 549001

It is a simple and original line loop with a snap that offers an easy fastening and avoids accidental opening. **(Block not included!)**

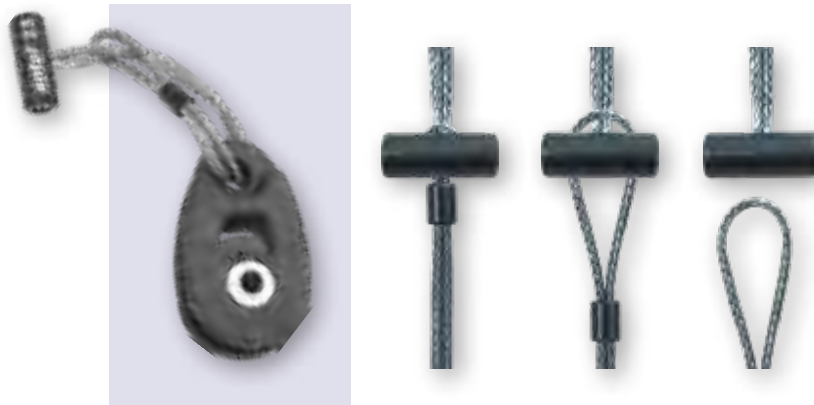

**Snatch block D=40 and 60mm**

The cheekplate revolves around the sheave axle allowing the block to open; a safety ball stops the block from opening with an adjustable screw to set the ball on locked position. Sheave with composite fibre main bearing and double side ball bearing. Hard anodized and teflon coated aluminum cheekplates with side rubber protections (yellow rubber on the revolving cheekplate).



549040/SH

549040/SN

549040



Standard model can be attached Spectra or Dyneema line.



Model /SH is supplied with Ø 6mm shackle.



Model /SN is supplied with a snap-shackle (HR).

# Dyna block

**Dyna Snatchblok**

The new Antal Dynablock with revolving resin cheekplates and with a Dyneema snap loop. A light and reliable solution that offers an easy, fast and safe connection. The resin sheave is on composite fibre bushing with two side ball bearings.



Item Code	Ø Line mm	D mm	SWL kg	Weight g	Fixing
54DBS44	10	44	600	80	Dyneema snap loop
54DBS56	12	56	1000	140	Dyneema snap loop



Low Friction Rings

Low friction rings

Four models with holes from 10 to 28mm, the simplest idea for maximum load and minimum weight.

Item Code	D1 mm	D2 mm	Ø mm	T mm	Weight g	SWL kg
54R1007	10	25	7	12	5	800
54R1410	14	35	10	15	12	1600
54R2014	20	50	14	22	44	3200
54R2820	28	70	20	31	120	6400

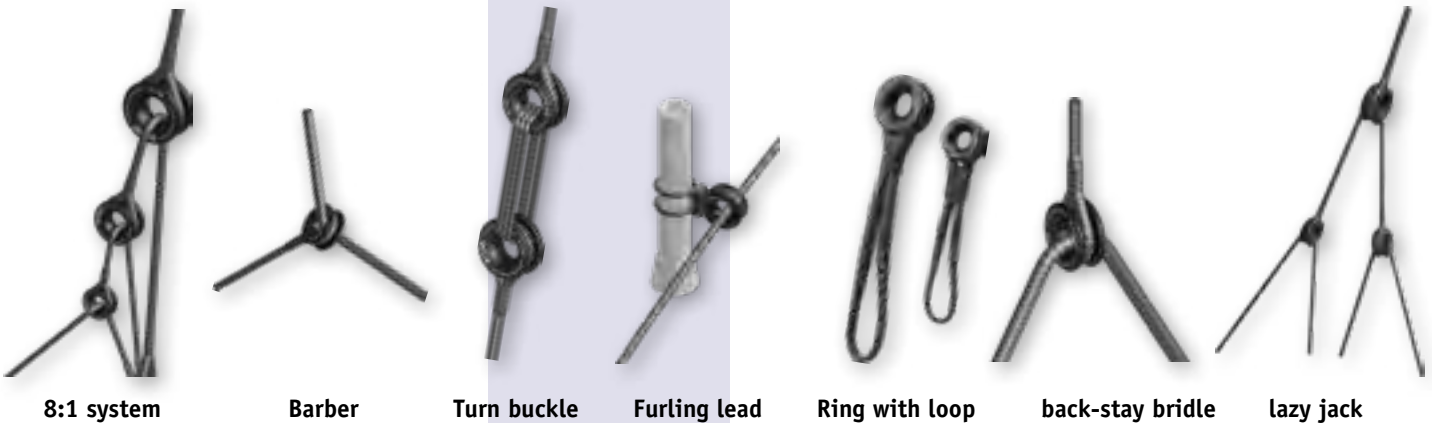
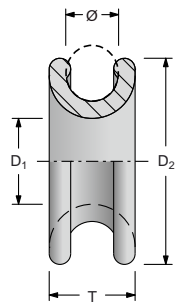

The Universal Solution

**antal**

8:1 system

Barber

Turn buckle

Furling lead

Ring with loop

back-stay bridle

lazy jack

Item Code 54R20.20  
Hard Black Anodized Aluminum  
Weight = 44g  
Fasteners = 2 x Ø6mm screws (not included)  
SWL = 800kg



Item Code 54R20.20/S  
Polished Stainless Steel  
Weight = 120g  
Fasteners = 2 x Ø8mm screws (not included)  
SWL = 1500kg

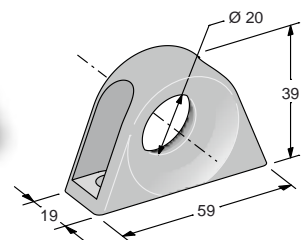

Low Friction Deck Rings

### Rings en loops

The Antal Low Friction Rings are available also with a Dyneema\* loop for a fast and easy connection.

Item Code	D mm	L mm	SWL kg	LOOP+RING (Item Code)
54RL4.0	10	70	400	4mm Dyneema + 54R1007
54RL4.5	10	80	700	4.5mm Dyneema + 54R1007
54RL5.0	14	90	900	5mm Dyneema + 54R1410
54RL6.0	14	110	1500	6mm Dyneema + 54R1410
54RL6.1	20	130	1500	6mm Dyneema + 54R2014

\* Dyneema is a superstrong polyethylene-based synthetic fiber (UHMWPE = ultra high molecular weight polyethylene) with a tensile strength of 3 to 4GPa (3000-4000 N/mm²).



Rings & Loops

### Hook

It can be easily "hooked" to a genoa or a spinnaker sheet: the lightest and strongest solution for a line control. Aluminum made, highly polished and hard black anodized with a spliced Dyneema Snap Loop. A safety spring prevents the line from going out. Spare Dyneema Loops are available. The pad-eye in the picture is not included. Dyneema Loop safety factor (breaking load / safe working load) = 3.

Code	Ø max line	SWL	Breaking Load	Weight
54HK12	12mm	1500kg	4500	80g
54HK16	16mm	2200kg	6600	130g

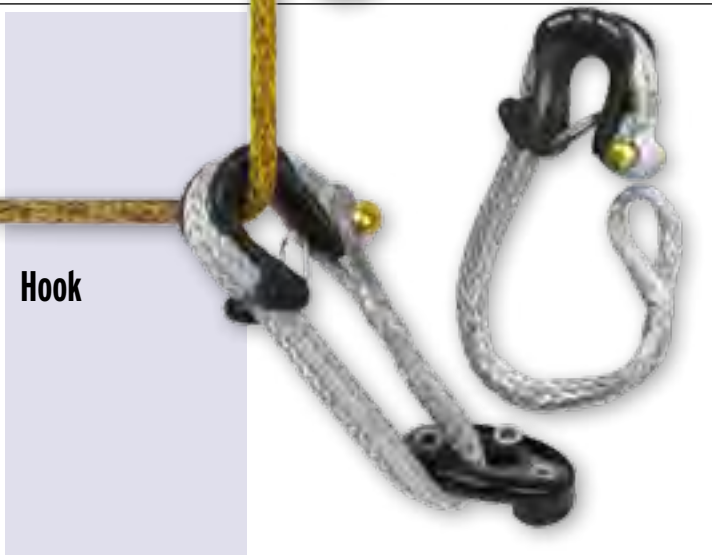

Hook

### Snap loops

It's a Dyneema loop that can be opened, with an easy and safe lock system. Two sizes with 4 or 5mm lines with different lengths. It will be used as a single, double or triple ring.



Item Code	Ø mm	Totale Length cm	Type	SWL kg
54SL4S	4	30	SINGLE	600
54SL4D	4	50	DOUBLE	1200
54SL4T	4	70	TRIPLE	1800
54SL5S	5	30	SINGLE	1000
54SL5D	5	50	DOUBLE	2000
54SL5T	5	70	TRIPLE	3000



Snap loops

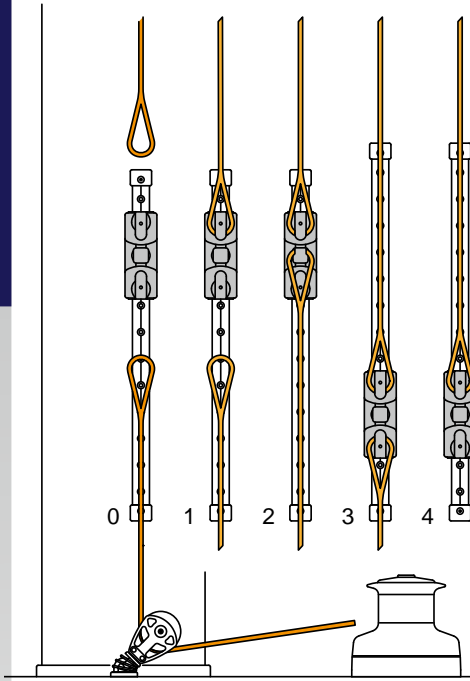

Halyard Sliders

**Halyard slider**

The "halyard slider" has been specifically planned for wire halyards and for those halyards which are subject to such high strain as to preclude use of a stopper. This solution permits easy adjustment and secure locking of halyards.

- Stop pin with 2 positions: lock-up and automatic insertion.
- Track: with close bore-holes (step 50mm) for precision adjustment.

The "halyard slider" is made in three sizes for 32x6 and 40x8 T-shaped tracks.

**Adjusting and blocking the halyard**

1. hook the halyard to the slider
2. connect the winch
3. put the halyard under tension and lock it in place
4. free the slider from the winch

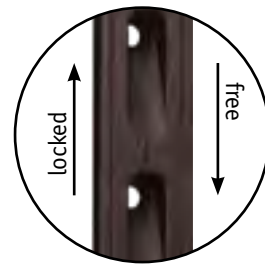

**antal**

**Automatic track**

The special shape of the holes allows the car moving with the stop pin on and the automatic car lock in the new position.

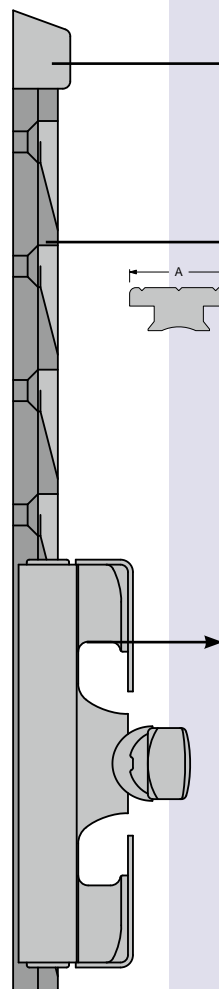
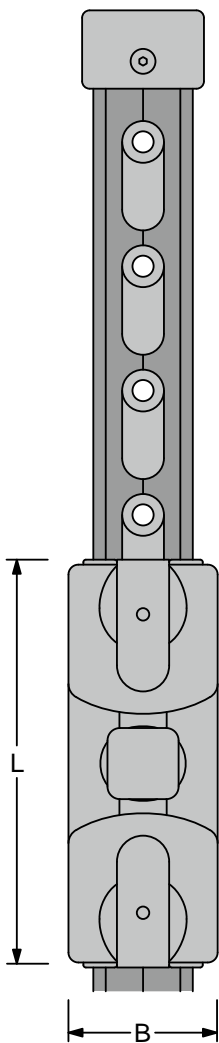

**Item Code 61241/B**  
End fitting  
Hard black anodized alu.  
For 32mm T-Track

**Item Code 61341/B**  
End fitting  
Hard black anodized alu. For  
40mm T-Track

**Item Code 602312**  
32x6 automatic track  
Screws = Ø6mm  
Hole spacing = 50mm  
Weight = 0.80kg/m

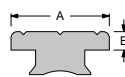

**Item Code 602313**  
40x8 automatic track  
Screws = Ø8mm  
Hole spacing = 50mm  
Weight = 1.30kg/m

**Item Code 622402**  
**32x6 slider**  
L = 135mm  
B = 50mm  
Weight = 0.40kg/m  
SWL = 2800kg

**Item Code 623402**  
**40x8 slider**  
L = 160mm  
B = 60mm  
Weight = 0.80kg/m  
SWL = 3800kg

**Item Code 624402**  
**40x8 slider double pin**  
L = 210mm  
B = 60mm  
Weight = 1.20kg/m  
SWL = 5800kg



622402

623402

624402

### Track adjustable cleat

From ANTAL two new moveable cleats for either 32mm or 40mm T-track. Cleats and slider are CNC machined from hard black anodized aluminum. Low profile design. Single screw-in stop pin keeps the cleat firmly locked in any position along the track, or locked open for ease of movement. Nylon insert on the slider for easier movement.



Track Adjustable Cleats

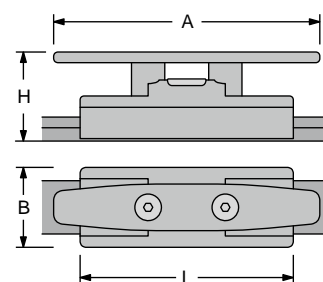

Item Code	Track mm	Stop pin Ø mm	A mm	B mm	H mm	L mm	Weight kg
622412	32x6	Ø11	170	49	55	132	0.45
623412	40x8	Ø14	200	60	67	160	0.78

# antal

### T-Tracks

Usually T-tracks are silver anodized, on request also hard black anodized version is available (add „/B“ to the model number).

AISI 316 s.steel track are also made on request (add „/S“ to the model number): **Starting from 32mm.**



T-Track

Item Code	T-Track mm	Fastening Ø mm	Hole Spacing mm	Weight kg/m
602211	26x4	5	50	0.5
602112	32x6	6	100	0.8
602212	32x6	6	50	0.8
602113	40x8	8	100	1.3
602213	40x8	8	50	1.3

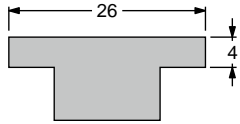

**Item Code 602211 „T“ TRACK 26x4**

High resistance silver anodized light alloy extrusion.  
 Max length = 3m  
 Weight = 0.5kg/m  
 Fasteners = 5mm screws  
 Hole spacing = 50mm

**Item Code 691141**

Simple end fitting  
 Plastic made, fastened with one 5mm screw.

**Item Code 691151**

End fitting with sheave

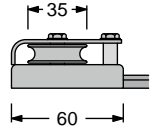

**26x4  
Genoa Cars**

**antal**

For boats up to 33 ft

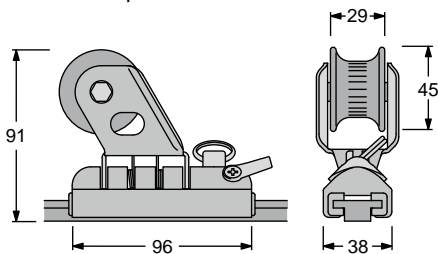

**Item Code 621492** Genoa car 26x4

Hard black anodized with A316 stop pin and nylon sliding inserts.  
 The sheave structure, made in AISI 316 s. steel, turns left and right ( $\pm 50^\circ$ ).  
 Resin sheave with 2 side ball bearings, wide section for two sheets.  
 Weight = 0.40kg  
**SWL = 800kg**

For boats up to 30 ft

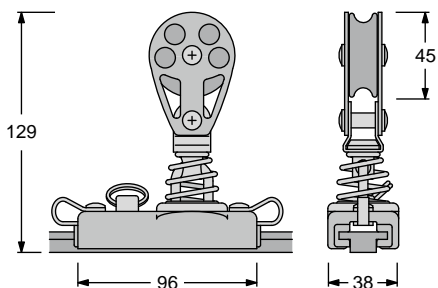

**Item Code 621452** Genoa car 26x4

A 45mm block with spring is fitted on the aluminum slider.  
 Also this model is supplied with the stop pin.  
 Weight = 0.40kg  
**SWL = 450kg**

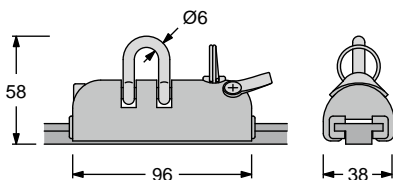

**Item Code 621462** Simple slider

A 6mm shackle is fitted on the hard black anodized slider.  
 AISI 316 s. steel stop pin and nylon sliding inserts.  
 Weight = 0.21kg  
**SWL = 800kg**



**Item Code 602112** „T“ TRACK 32x6 with 100mm hole spacing

**Item Code 602212** „T“ TRACK 32x6 with 50mm hole spacing

High resistance silver anodized light alloy extrusion  
(See p. 625)

- Max. length = 6m
- Weight = 0.8kg/m
- Fasteners: 6mm screws
- Hole spacing: 50 or 100mm

**Item Code 622492 GENOA CAR 32x6**

Hard black anodized aluminum slider with low-friction nylon sliding inserts. The revolving upper structure ( $\pm 50^\circ$ ) is made of AISI 316 s.steel. The resin sheave is fitted with 2 side ball bearing, wide section for double sheet. AISI 316 s.steel pin with a lock-up position. Becket for remote control line.

Weight = 0.86kg

SWL = 2800kg

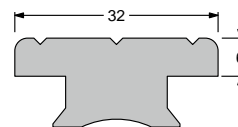

**antal**

**End fittings for 32x6 T-Track**

**Item Code 691241** made in plastic, or:

**Item Code 691241/AL** silver anodized alu

**Item Code 691241/B** black anodized alu

**Item Code 691241/S** AISI 316 s. steel

**32x6  
Genoa Cars**

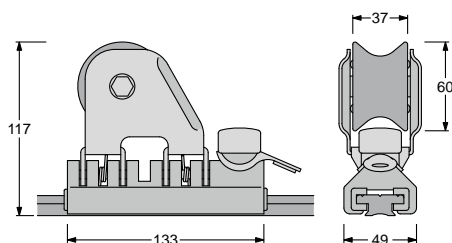

For boats up to 44 ft

**CAR CONTROL**

**Item Code 622492** Genua car 32x6

**Item Code 909502** 55mm block connected to the car.

**Item Code 690251** Black aluminum end fitting with one 50mm sheave (Weight 0.26kg).

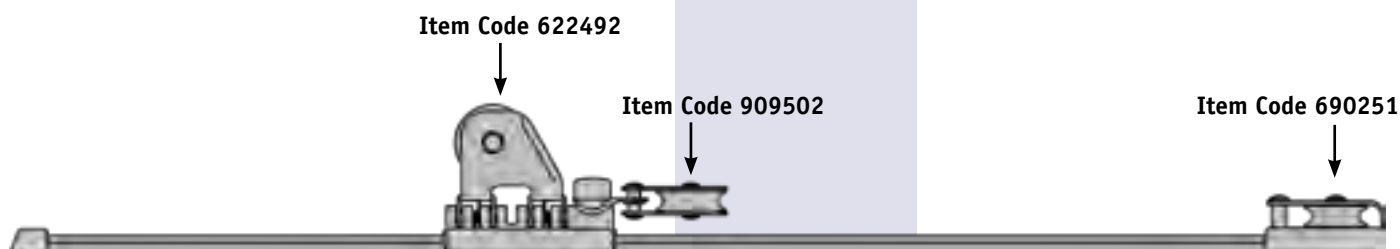

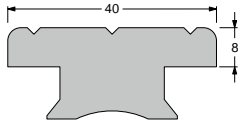

**40x8  
Genoa Cars**

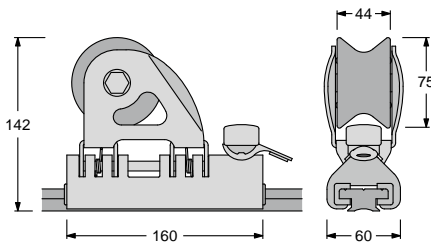

**Item Code 623492** For boats up to 52 ft

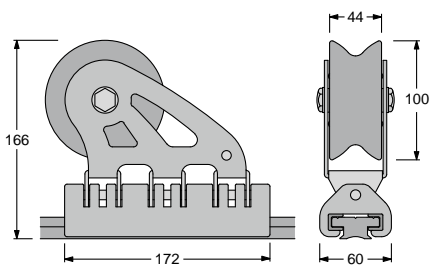

**Item Code 624492** For boats up to 60 ft

**Item Code 691722/AL**

Adjustable stop pin 40x8 For this double stop pin with alu slider the 50mm hole spacing track (Item Code 602213) is necessary.

**Item Code 691722/AL**

**Item Code 602113** „T“ TRACK 40x8 with 100mm hole spacing

**Item Code 602213** „T“ TRACK 40x8 with 50mm hole spacing

High resistance silver anodized light alloy extrusion (see p.625).

- Max. length = 6m
- Weight = 1.30kg/m
- Fasteners: 8mm screws
- Hole spacing 50 or 100mm

**Item Code 623492** Genoa car 40x8

Hard black anodized aluminum slider with low-friction nylon sliding inserts. The revolving upper structure ( $\pm 50^\circ$ ) is made of AISI 316 s.steel. The aluminum sheave is fitted with one main Composite Fibre bearing and 2 side ball bearing, wide section for double sheet. AISI 316 s.steel pin with a lock-up position. Becket for remote control line.

Weight = 1.50kg

**SWL = 3800kg**

**End fittings**

**Item Code 691341** made in plastic, or:

**Item Code 691341/AL** - silver anodized alu

**Item Code 691341/B** - black anodized alu

**Item Code 691341/S** - AISI 316 s. steel

# antal

**Item Code 624492** Genoa car 40x8 MAXI

Maxi slider, for boats up to 60 ft, runs on HS fibre sliding inserts on 40x8 "T" track (Item Code 602213). This car must be used with double stop pin slider \*(item Code 691722/AL).

Weight = 1.94kg

**SWL = 4800kg**

**Item Code 624492**





**Main ball bearing traveler - size 100**

This traveler is 98mm long and 62mm wide. The weight is 0.23kg and SWL = 820kg. Fitted with 1/4" balls (Torlon balls on the lower races and Delrin balls in the upper races).

The complete systems include 1.5m long track. The traveler is fitted with a special „standup“ joint for Antal blocks size 55mm. The same traveler is also available with a 6mm shackle: add „/SH“ to the Item Code.

The sheaves for the car control are D=35mm.



↑  
Item Code 544100

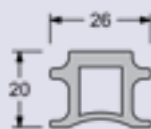
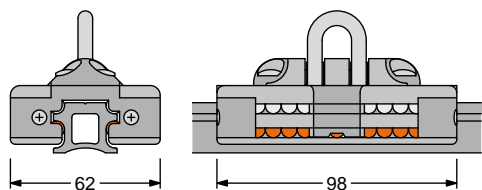

Item Code 544100/SH

**Main Travelers  
Size 100  
for boats  
up to 33 ft**

Item Code 544261



Item Code 544901  
complete set

Item Code 691421



Item Code 544262



Item Code 544902  
complete set

Item Code 544100



Item Code 544101



Item Code 544266



**antal**

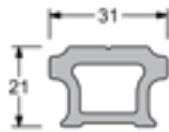

**Main Travelers  
Size 110  
for boats  
up to 36ft**



**Main ball bearing traveler - size 110**

This traveler is 110mm long and 70mm wide. The weight is 0.50kg and SWL = 1000kg. Fitted with 1/4" balls (Turlon balls on the lower races and Delrin balls in the upper races).

The complete systems include 1.5m long track. The traveler is fitted with a special „standup“ joint for Antal blocks size 65mm. The same traveler is also available with a 8mm shackle: add „/SH“ to the Item Code.

The sheaves for the car control are D=45mm.

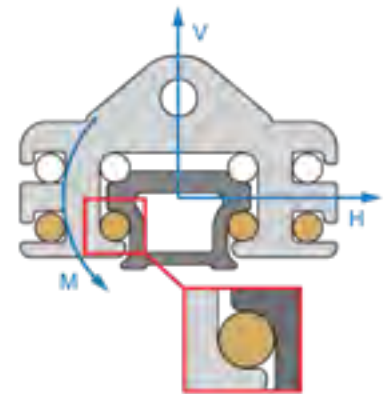

**Item Code 544913  
complete set 2:1**



**Item Code 544914  
complete set 3:1**



**Main ball bearing traveler - size 150**

This traveler is 150mm long and 70mm wide. The weight is 0.70kg and SWL = 1400kg. Fitted with 1/4" balls (Torlon balls on the lower races and Delrin balls in the upper races).

The complete systems include 1.5m long track. The traveler is fitted with a special „standup“ joint for Antal blocks size 75mm. The same traveler is also available with a 8mm shackle: add „/SH“ to the Item Code.

The sheaves for the car control are D=45mm.



**Main Travelers  
Size 150  
for boats  
up to 42ft**

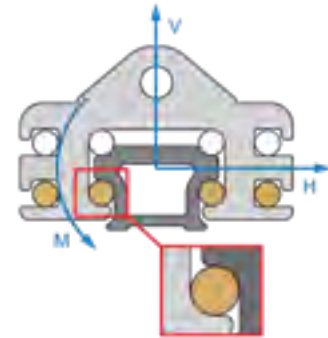
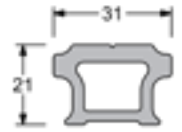

**Item Code 544951  
complete set 3:1**



↑  
**Item Code 544153**

**Item Code 544274**



↑  
**Item Code 544410**

**Item Code 544952  
complete set 4:1**



↑  
**Item Code 544154**

**Item Code 544275**



↑  
**Item Code 544410**



**Plastic Blocks  
with reinforced  
Side-Plates of  
Stainless Steel**



**6mm Blocks**

**8mm Blocks**

Item Code	Item Code	
105000 (A)	116000	Single Block
105100 (B)	116100	Single Block with Becket
105200 (C)	116200	Single Block with Swivel
105600 (D)	116700	Triple Block
105900 (E) 40 x 22mm	116900 45 x 24mm	Thru-Deck
106500 (F)	117100	Turning Block
106200 (G)	116300	Single Block with Swivel
105700 (H)	116800	Triple Block with Becket
105500 (I)	116500	Double Block
105400 (J)	116600	Double Block with Becket
106300 (K)	117300	Triple Block with Cleat
106400 (L)	117400	Triple Block with Becket and Cleat
106001 (M)	117200	Turning Block for Stanchion Mount (Stanchion Ø=25mm)
(N)	117000	Swiveled Block with Cleat



**DELRIN® BALL BEARING**  
BREAKING LOAD 700kg  
WORKING LOAD 100kg

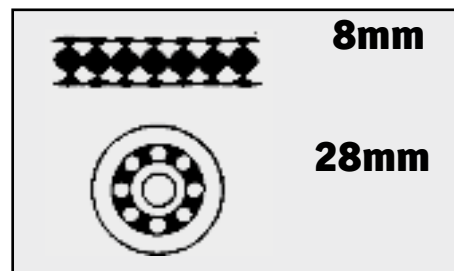

**DELRIN® Ball bearing**  
BREAKING LOAD 750kg  
WORKING LOAD 150kg

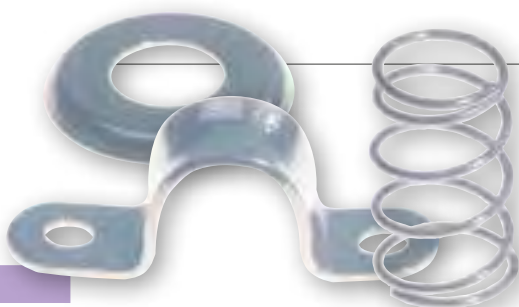

**Assembly-Kit for  
Block 116300**

Item Code 242600	Capping Ring
Item Code 242300	Stand-up Spring
Item Code 350200	Eyestrapp



## Plastic Blocks with reinforced Side-Plates of Stainless

### 10mm Blocks

### 12mm Blocks

Item Code		Item Code	
900100	(A)	--	Single Block
900200	(B)	--	Single Block with Becket
900300	(C)	910100	Single Block
900400	(D)	910200	Single Block with Becket
900800	(E)	910600	Fiddle Block with Cleat
900600	(F)	910300	Fiddle Block
900700	(G)	910400	Fiddle Block with Becket
900500	(H)	--	Single Block with Swivel
900900	(I)	910700	Fiddle Block with Becket and Cleat
901200	(J)	910900	Double Block
901300	(K)	911000	Double Block with Becket
901600	(L)	911300	Turning Block
901100	(M)	910500	Single block with Becket and Cleat
901400	(N)	911100	Triple Block
901500	(O)	911200	Triple Block with Becket

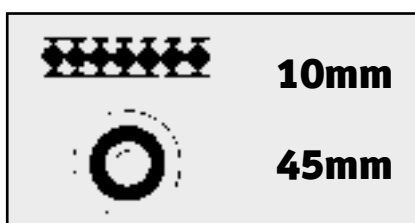

**10mm**

**45mm**

**without ball bearing**

BREAKING LOAD 950kg  
WORKING LOAD 370kg

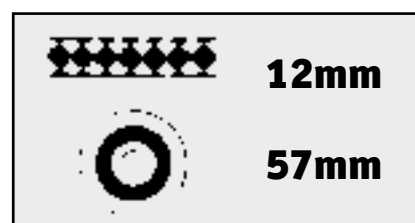

**12mm**

**57mm**

**without ball bearing**

BREAKING LOAD 1450kg  
WORKING LOAD 580kg

### 10mm Blocks

### 12mm Blocks

351400	Base Plate (P)	351400	Base plate
242300	Spring (Q)	242400	Spring
242500	Capping Ring (R)		
541000	Connection-Swivel for assembling of Block 901100 with 10mm Double- or Triple-Blocks (S)		
541100	Connection-Swivel for assembling of Block 910500 with 12mm Double- or Triple-Blocks (S)		
293000	Snap Shackle for 10mm Blocks (T) with „3-way“ head		
293100	Snap Shackle for 12mm Blocks (T) with „3-way“ head		

The most of these 10 or 12mm blocks are sold with a 3-way universal connection item. The Becket can be adjusted in a 90°- or 180°-position. Possible is a rotating installation too.

## Assembly-Kit for mounting on Deck on a Spring for all blocks with a universal „3-way“ head

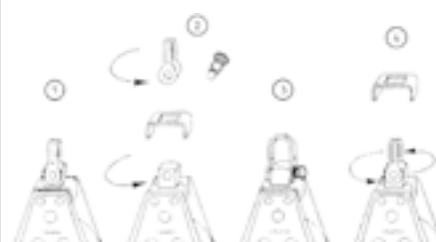



### Ratchet-block

**Item Code 141000**

Single block, 10mm ratchet-block, ball bearing, sheave from aluminum Ø57mm. Breaking load 900kg, working load 220kg.



### Ratchet-block

**Item Code 141100**

Single block, 10mm ratchet-block, ball bearing, sheave from aluminum Ø57mm. Breaking load 900kg, working load 220kg.

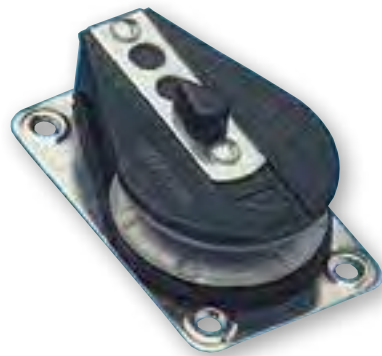

### Ratchet-block

**Item Code 141200**

Single cheek block, 10mm ratchet-block, ball bearing, sheave from aluminum Ø57mm. Breaking load 900kg, working load 220kg, right.

**Item Code 141300**

Single cheek block, 10mm ratchet-block, ball bearing, sheave from aluminum Ø57mm. Breaking load 900kg, working load 220kg, left.



### Stand-up Block

**Item Code 200600**

Stand-up Block 10mm with ratchet and cleat, sheave from aluminum Ø57mm on a rotating aluminum-socket, sheave and socket ball bearing. Breaking load 900kg, working load 220kg.

**Item Code 200700**

Like Item Code 200600, but without Block. For Blocks with a universal „3-way“ head.



### Cam Cleat

**Item Code 200900**

Rotating cam cleat with guide loop, socket from stainless steel.



### Ratchet-block

**Item Code 141400**

Single ratchet-block, 10mm, with cleat and swivel for connecting with double- or triple-blocks.



### Cable-Block

**Item Code 891000**

Cableblock for wire rope, Ø4mm. Sheave from aluminum.

allpa travellers are equipped with a ball-running-system of Delrin® balls. This is the reason why these travellers can be moved so easily, even under very high loads. If the power of the mainsheet works in an angle below of 10°/15°, use chiefly a traveller with movable clevis. Maintenance: wash up regularly with fresh water.

Cleats and blocks are suitable for lines of Ø 10mm.

The short (115mm) Travellers are suitable for a working load of max. 270kg. The long (150mm) Traveller shall be used for a working load of max. 470kg.

## Traveller-Systems

- Item Code 244000 (A)** Aluminum-Traveller with capping-plate (stainless steel) and guide roller, l=115mm, w=60mm, h=24mm, working load 270kg
- Item Code 244300 (B)** Aluminum-Traveller with capping-plate (stainless steel) and guide roller, l=150mm, w=60mm, h=24mm, working load 470kg
- Item Code 247000 (C)** Aluminum-Traveller with movable clevis, l=115mm, w=60mm, h=24mm, working load 270kg
- Item Code 247100 (D)** Aluminum-Traveller with movable clevis, l=150mm, w=60mm, h=24mm, working load 470kg
- Item Code 244200 (E)** Aluminum-Traveller with guide roller and jam cleat, l=150mm, w=60mm, h=24mm, working load 470kg
- Item Code 244400 (F)** Aluminum-Traveller with movable Block, l=150mm, w=60mm, h=24mm, working load 470kg
- Item Code 244500/1 (G)** Aluminum-Traveller-X-track, L=1500mm
- Item Code 244500/2 (G)** Aluminum-Traveller-X-track, L=2000mm
- Item Code 244500/3 (G)** Aluminum-Traveller-X-track, L=3500mm, Dim. 25x16mm, bore Ø5mm, Hole spacing 100mm
- Item code 246100 (H)** Kit of Delrin® balls Ø1/4" (62St.), short Traveller
- Item code 246200 (H)** Kit of Delrin® balls Ø1/4" (84St.), long Traveller
- Item code 244600 (I)** Track End Stop X-track with rubber-stop
- Item code 244700 (J)** Endstop (stainless steel) with single block
- Item code 244800 (K)** Endstop (stainless steel) with single block and cleat
- Item code 245000 (L)** Endstop (stainless steel) with double block
- Item code 245100 (M)** Endstop (stainless steel) with double block and cleat
- Item code 244900 (N)** Endstop (stainless steel), no block, no cleat

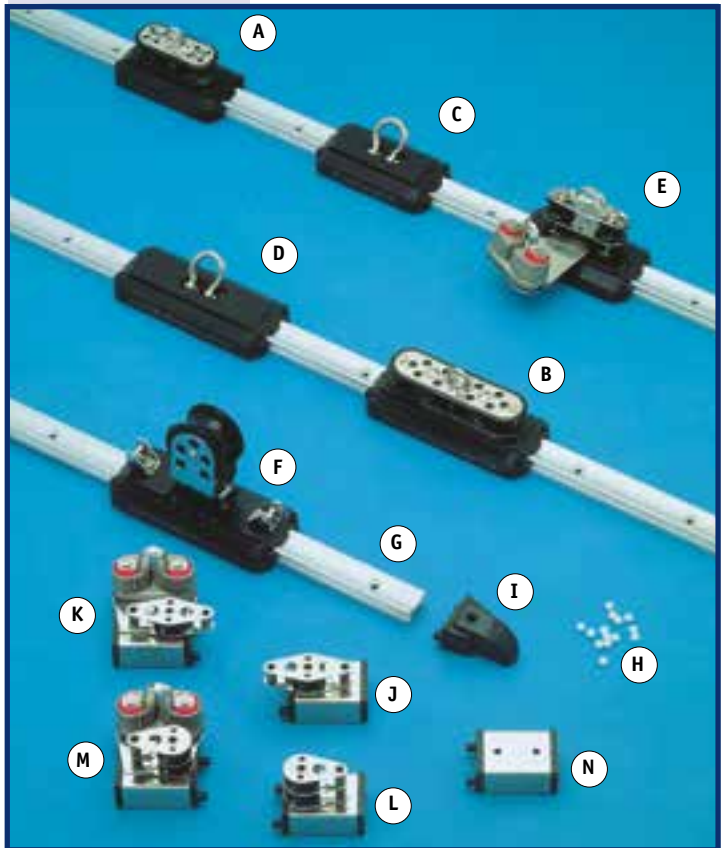

Code 244500  
A = 25mm  
B = 16mm

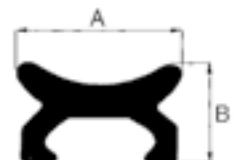



**Slider of stainless steel**

**Item Code 230500**

Slider of stainless steel with guide loop and locking pin for U-track of stainless steel.



**Stainless U-Track Slider with rotating fairlead eye and cleat**

**Item Code 230400**

with cleat, rotating fairlead eye and locking pin for U-track of stainless steel.



**End Stop**

**Item Code 230700**

End stop for U-track



**Stainless U-Track Slider with rotating fairlead eye**

**Item Code 230600**

with rotating fairlead eye and locking pin for U-track of stainless steel.



**U-Track of Stainless Steel**

**Item Code 230100**

U-track of stainless steel, width=25mm, height=7mm, material=1,2mm, opening=12mm, length: 1000mm



**Genoa Lead Block**

**Item Code 232100**

Aluminum genoa lead block with cheeks, reinforced by stainless steel, for aluminum genoa T-track 25mm.  
Max. sheet ø14mm

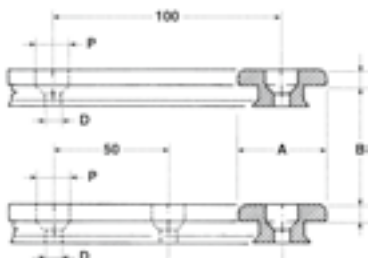
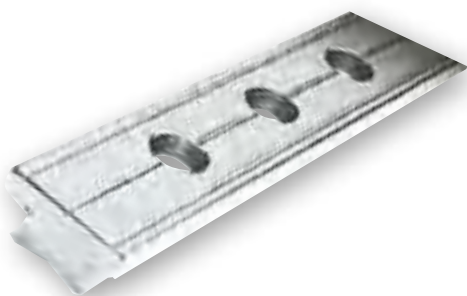

**Aluminum Genoa T-Track silver coloured anodized**

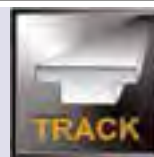

Item Code	AxB mm	P mm	D mm	Weight (kg/m)	Hole space mm
602211	26x4	10	5	0,5	50
602112	32x6	13	6	0,8	100
602212	32x6	13	6	0,8	50
602113	40x8	16	8	1,3	100
602213	40x8	16	8	1,3	50



**Item Code 251200**

Stainless fairlead for cleat 251000

Stainless

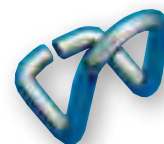

**Item Code 251300**

Wedge base 15° for item 251000

**Item Code 254000**

Wedge base 15° for item 253000/253200

Wedge Socket

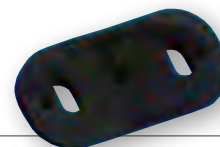

**Item Code 254200**

Stainless fairlead for item 253200/253000

Stainless Fairlead

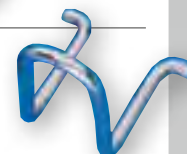

Because of the ingenious design the sheet is to be cleated very easily. The Delrin® ball bearing cleats ensure for a perfect effect, even at high load.

**Item Code 251000**

Nylon-Cleat without fairlead, for sheets of Ø3-8mm

allpa® Cam Cleats with Ball Bearing



hole center 37mm

An ingenious design makes cleating the sheet more than easily. A perfect effect, even at high load, is ensured by the Delrin® ball bearing cleats. The special stainless springs look to a constant pressure to the cam cleats.

**Item Code 253200**

Nylon-Cleat without fairlead, for sheets of Ø5-14mm

**Item Code 253000**

Aluminum-Cleat without fairlead, for sheets of Ø5-14mm

allpa® Cam Cleats with Ball Bearing



hole center 37mm

**Item Code 260200**

Nylon-Camcleat for Ø3-6mm bore Ø4mm, hole spacing 52mm

**Item Code 260300**

Nylon-Camcleat for Ø3-6mm bore Ø4mm, hole spacing 66mm Closed

**Item Code 260400**

Nylon-Camcleat for Ø6-12mm bore Ø6mm, hole spacing 72mm Open



260300

Cam Cleats



260400



260200

**Item Code 254100**

Straight base for mounting of fairleads, for item 253000/253200

Base for fairleads, straight Form

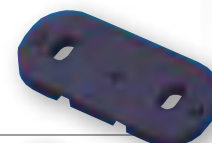

**Item Code 260500**

Aluminum-Camcleat for Ø3-6mm bore Ø4mm, hole spacing 36mm

**Item Code 260601**

Aluminum-Camcleat für Ø6-12mm bore Ø6mm, hole spacing 72mm

Cam Cleats



assembling illustration

**Item Code 261001**

Aluminum-Cam Cleat with sheave for trapeze gear for lines of Ø4-8mm, L=70mm

Trapeze Gear





151100



116900

**allpa® Turning Block and Deck Inlet Block**

With Delrin® sheaves

Item Code	Øsheave mm	max.Ø mm	breaking load (kg)
151100 stainless steel	22	8	500
116900 stainless steel	28	8	400



105900



152200

**allpa® Turning Block and Deck Inlet Block**

With Delrin® sheaves

Item Code	Øsheave mm	max.Ø mm	breaking load (kg)
105900 stainless steel	22	6	500
152200 stainless steel	55	12	800



154000



153300

**allpa® Single cheek and pivoting Block**

With Delrin® sheaves

Item Code	Øsheave mm	max.Ø mm	breaking load (kg)
154000 stainless steel	45	10	300
153300 stainless steel	55	12	1400

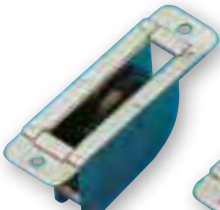

152400



152500

**allpa® Deck inlet Blocks**

With Delrin® sheaves

Item Code	Øsheave mm	max.Ø mm	breaking load (kg)
152400 stainless steel	38	8	700 (Flat)
152500 stainless steel	38	8	700 (Rounded)

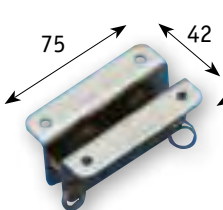

151800

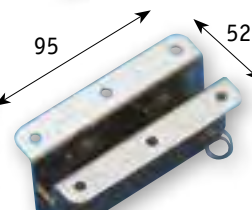

151900

**allpa® Double deck inlet Blocks**

With Delrin® sheaves

Item Code	Øsheave mm	max.Ø mm	breaking load (kg)
151800 stainless steel	25	8	560
151900 stainless steel	33	10	600

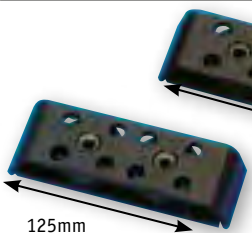

154500

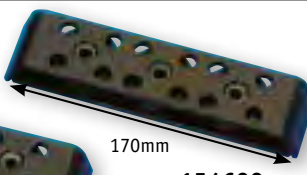

154600

**allpa® organizers**

With Delrin® sheaves - Ball Bearing

Item Code	Øsheave mm	max.Ø mm	breaking load (kg)
154500 Aluminum	2x38	10	800
154600 Aluminum	2x38	10	1000

hole spacing = 44mm



These kits are completed with rudder blade head of aluminum, tiller l=1000mm, duty pintles and gudgeon of stainless steel. Fitted to rudder blades of 20mm thickness.

Item Code		A mm	B mm	C mm	D mm	E mm
510100	Rudder kit long	330	212	220	90	115
510500	Rudder kit short	240	200	165	75	160
510600	Stainless Rudder blade retainer					

### allpa® Complete Rudder Kit for Sailing Dinghies

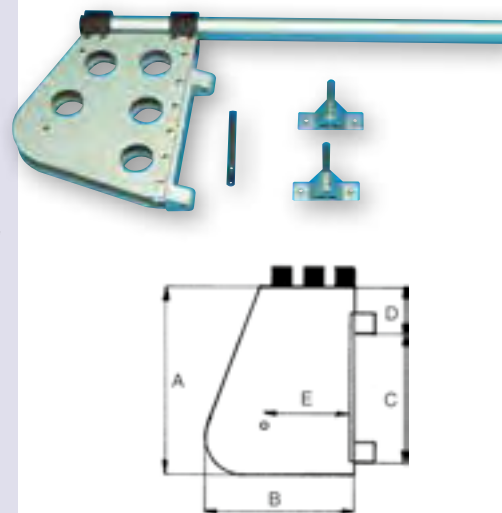

#### Item Code 520800

Stainless rudder fitting for gudgeon Ø10mm, l=132mm. For rudderblade-/ rudder head thickness of 35mm.

#### Item Code 521200

Stainless rudder fitting for gudgeon Ø10mm, l=179mm. For rudderblade-/ rudder head thickness of 35mm.

### Rudder Fittings for Dinghies



#### Item Code 521900

Aluminum stern fitting with stainless gudgeon, Ø10mm, length of gudgeon 35mm, bore Ø6mm, hole spacing 60mm

#### Item Code 522000

Aluminum stern fitting with stainless gudgeon, Ø10mm, length of gudgeon 44mm, bore Ø6mm, hole spacing 60mm

### Stern Fittings for Dinghies

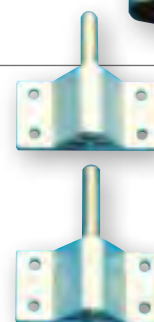

Tiller extension, black anodized aluminum, plastic joint and comfortable „golfgrip“ handle.

**Item Code 511000** L= 610mm

**Item Code 511100** L= 760mm

**Item Code 511200** L= 910mm

**Item Code 511300** L=1070mm

### Tiller Extension



**Item Code 048950** With 2 x 3 nylon-sheaves, sheave Ø25mm, for lines Ø4mm, dim. 277 x 30 x 30mm (l x w x h), bore: 4 x Ø4mm, hole spacing: 12 x 261mm

**Item Code 048960** With 2 x 4 nylon-sheaves, sheave Ø35mm, for lines Ø4mm, dim. 326 x 40 x 40mm (l x w x h), bore: 4 x Ø5mm. hole spacing : 20 x 301mm

### Stainless Steel Trim Boxes

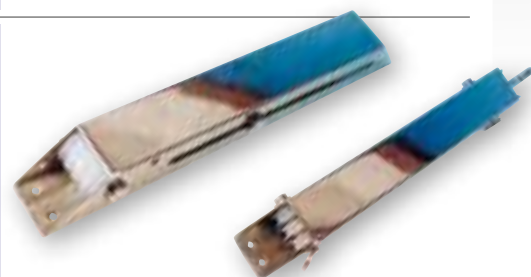

## TABLE OF CONTENTS

**A**

allpa® = a-Flex CV-Shafts	559, 562	Air-Conditioning Systems	416-419
allpa® = Airconditioning Systems	416-419	Alignment Valve for Hydraulic Steering	061
allpa® = Antal Winches & Deck Equipment	622-657	All Round Lights	377-379, 381-384
allpa® = Automatic Life Jackets 150N & 275N	253-255	Allcord Ropes	241-244
allpa® = Batteries	388-389	All-In-One Electrical Cabinet	394
allpa® = Centa Flexible Couplings	556-559	allpa Hydraulic Steering Systems	036-059
allpa® = Compasses	260-270	Aluminum Anodes	128-137
allpa® = Echomax Radar Reflectors	248	Aluminum Propellers	585
allpa® = Flange Adapters	555	Aluminum Stern Tube	572
allpa® = Generating Sets	408-415	Ampere Meter	322-324, 326-327
allpa® = Goïot Hatches	616-620	Anchor Ball, Cone, black	204, 237, 249
allpa® = Hyundai Seasall Scheepsmotoren	531-533	Anchor Bow Rollers	235-236
allpa® = Johnson Pump Pumps 476-477, 482-483, 485-491, 494-498		Anchor Buoy's	214
allpa® = Johnson Pump Toilets	446-451	Anchor Chain	234
allpa® = Lofrans Windlasses	218-226	Anchor Chain Links	234
allpa® = Polar Star Damper Plates	548-549	Anchor Chain Stainless Steel	234
allpa® = Radice Rudders and Propellers	065, 580-585, 587	Anchor Lights	377-379, 381-384
allpa® = Refrigerators	420-428	Anchor Ropes	234, 239, 245-246
allpa® = Regatta Life Jackets & Floatation Suits	250-259	Anchore Ropes Leaded	234, 239
allpa® = Ritchie Compasses	262-270	Anchors	232-233
allpa® = Rudder Arms and Glands	064	Anchors and Accessories	232-237
allpa® = SeaStar Jack Plates	125-127	Annular Fenders	215
allpa® = SeaStar Steerings & Controls	022-081	Anodes	128-137
allpa® = SeaStar Trim Tab Systems	094-100	Anodes for Outboards & S-Drives	128-135
allpa® = Selva Outboards	178-184	Anodes for Propeller Shafts	131, 136-137, 568, 588
allpa® = Shore Power Fittings & Cables	405-407	Anodes Navalloy	128-131
allpa® = Solé Marine Diesel Engines	506-524	Antal Winches & Deck Equipment	622-657
allpa® = Springfield Boat Chairs	148-161	Antares 150N & 275N	254
allpa® = Technodrive Marine Reversing Gears	535-547	Antenna Bases	350
allpa® = X-Force Bow Thrusters	090-093	Antenna for Radio	351
12V Socket	344-345, 347	Anti-Foam Fuel Overflow	109
3-Way Fuel Valve, Brass	110	Anti-Foam-Overflow	109, 596
3-Way Valves	454-455, 459	Anti-Vibration Kit throttle & shift cables	081
Accumulator Tanks	479	Automatic Life Jackets	253-255
Active-X / XS-Band Radar Target Enhancer	248	Autopilot Pump	044
Adjustable Belt with Buckle	187, 284	Awning Blinds	615, 619
Adjustable Belt with Stainless Steel Buckle	284	Axial Propeller Shaft Seals	574-575
A-Flex CV-Shafts	560-563		
Air Conditioning	416-419	<b>B</b>	
Air Heating Systems	416-419, 613	Baby Life Jacket	251
Air Vent Kits for Cooling & Exhaust	606-607	Back Stay Tensioners	621
Air Vents for Toilets	454-456	Bailer	197
		Ball Valves	459, 463, 470, 604

## TABLE OF CONTENTS

Ball Valves Plastic	201, 463	Boat Chairs	148-161
Ball Valves PVC	201, 463	Boat Cleaning Products	190-191
Ballast Pump	487	Boat Cover Support Poles	173
Balljoints for SeaStar Cylinder	062	Boat Cover Support System	173
Barbecue Electric	436	Boat Covers	173
Barrel Bolts	285	Boat Hook Bilge Pump	189
Bathing Ladder Wood	311	Boat Hooks	189
Bathing Ladders	215, 310-316	Boat Horns	245-247
Bathing Ladders Telescopic	314-315	Boat Propellers, Bronze & Aluminum	579-587
Bathing Platform Lighting	363, 374-375	Boat Trailer Accessories	186-187
Bathing Platforms	316	Boats	174-177
Batteries	388-389	Boatswain's Chairs	196
Battery Boxes	121	Boilers	472-475
Battery Cables & Eyelets	389	Bollards	274-277
Battery Cables, Terminals & Eyelets	389	Bosun's Chairs	196
Battery Chargers	392-394, 396-399	Bottle Holder	273
Battery Guard	403-404	Bow Fenders	214
Battery Guard and Fuse	322-324, 326-327, 390-391, 403-404	Bow Ladders	313
Battery Main Switches	336-337, 395, 403	Bow Protector Stainless Steel	236
Battery Monitoring Instruments	390-391	Bow Rollers	186-187, 235-236
Battery Selection Switches (also double pole)	336-337, 395, 403	Bow Thrusters	090-093
Battery Separators	395, 402-403	Bowls Washing	435, 438-439
Battery Switches	336-337, 395, 403	Bravo Electric Inflator Pump	168-169
Battery Terminals	389	Breather Nipples	112, 454-456, 461, 606
Battery Watch	390-391, 403-404	Breton Course Plotter	271
BayStar Outboard Steering Systems	036-037	Bronze Propellers	579-584, 586-587
Bearing Grease	107	Bucket	191, 197, 486
Bellows	135	Bucket Seats	150-151
Bilge Pump Filter	460, 484	Built-In Boxes	292-295
Bilge Pumps	482-485, 489, 492-493	Built-In Fuel Tanks	109-110, 597
Bilgewater Alarm	483	Buzzer with LED-Indicator	340
Bimini Tops	163-167		
Bimini Tops Accessories	162-167	<b>C</b>	
Black Signal Cone	249	Cabin Lamps	352, 356-362, 364-372
Black Water Pumps	455-456, 485, 488-489, 492-493	Cabin Lights	352, 356-362, 364-372
Bleed Nipple Caps all SeaStar Cylinders	062	Cable & Wire Protecting System for Outboards	117
Blocks	634-644, 646-647, 658-660, 664	Cable Leads (electric)	338
Blocks OPF	640-643	Cable leads (steering cable)	118
Blocks Snatch	647	Cable Steering Systems	022-034
Blocks Special	646-647	Cable Steering Systems mechanical	022-034
Blocks Stainless Steel	636-637, 644, 646, 664	Camcleats	634, 636, 640, 642, 644, 658-660, 662-663
Blowers	307-308, 609-610	Capstans	218, 222
Boat Boilers	472-475	Carbon Odor Filters	455-456, 597

## TABLE OF CONTENTS

CEE Power Plugs	406-407	Cowl Ventilators	308-309, 610-611
Ceiling Lamps	352, 356-362, 373	Cowl Ventilators Stainless Steel	308-309, 610-611
Centa Flexible Couplings	556-559	Cup Holders	273
Chain	234	Curry Clamps	634, 636, 640, 642, 644, 658-660, 662-663
Chairs	148-161	Cushions	148
Chargers Battery	392-394, 396-399	CV-Drive Shaft Systems	560-563
Chart Reading Lamps	352, 364, 373		
Chart Reading Materials	271	<b>D</b>	
Cigarette Lighters	345	Damper Plates	548-549, 551-553
Circuit Panels with LED	325, 346-349	Damper Plates Polar Star	548-549
Circulation Pumps	491	Dashkit for Hydraulic SeaStar Helms	060
Cleaning Products	190-191	Davits	317
Cleats	274-277	Deck Blocks	635, 637, 641, 643-644, 659-660, 664
Clips Plastic	203	Deck Chairs	148-161
Common Rail Diesel Engines	531-533	Deck Entries Color Coded	469, 598
Compac-T Steering System	023	Deck Entries Nylon	469, 598
Compasses	260-270	Deck Entries Stainless Steel	469-598
Compression Fasteners	285	Deck Eyes Plastic	203
Cone Insert for Steering Wheels	069	Deck Eyes Screwed Stainless Steel	641, 643
Connection Bars for Electric Wiring	338	Deck Fillers	111, 469, 598
Connection Kits Control Cables	070	Deck Fittings & Tracks	622-665
Connection Kits Hydraulic Steering	061, 063	Deck Flood Light Lamp	381, 385-386
Connection Kits Mechanical Steering	033-034	Deck Flood Lights (LED)	381, 385-386
Containers, watertight	196-197	Deck Ventilators	308-309, 610-611
Control Boxes	075-080, 082-089	Deck Wash Kit for Pump F4B-19	487
Control Cables	072-073	Deck Wash Kit with Boat Hook	188
Controls	075-080, 082-089	Deck Wash Pumps	476, 480, 492-493
Controls Electronic	082-089	Deck Winches	622-627
Controls Mechanical	075-080	Dempflex	612
Conversion Kits Marine Toilets	454	Depth Sounders	322, 326-328
Converters DC/DC	402	Deviders	271
Cookers Electric	436	Diaphragm Pumps	485, 489, 492-493
Cookers Induction	436	Diesel (Fuel) Pumps	479, 492-493
Cooling compressors	428	Diesel Engines	506-524, 531-533
Cooling Drawers Stainless Steel	424-425	Diesel Generating Sets	408-415
Cooling Units	428	Diesel Tanks	108-110, 597
Cooling Water Pumps	487, 491, 494-497	Dimmer	362, 367, 373
Cooling Water Strainers	605	Dinghies	174-177
Corrosion Stopper	404	Diode Battery Isolators	403
Cotter Rings Stainless Steel	211	Discharge Opening for Fire Extinguisher	272
Course Plotter	271	Dock Fenders	216
Courtesy Lights	368-370, 372	Dock Lights	363, 374-375
Covers for Bronze Impeller Pumps	502-503	Dock ring portable	237

## TABLE OF CONTENTS

Dog Vests	256	Energy Meter	390
Door Fasteners	202, 290-291	Engine Brackets for replacement Volvo/Yanmar	525
Door Handle	291	Engine Control Cables	072-073
Douche Accessories	444-445	Engine Controls Electronic	082-089
Drain Plugs	170, 172, 200-201	Engine Controls Mechanical	075-080
Drain Plugs and Sockets	170, 172, 200-201	Engine Installation Kits	527
Drains for Sincs	440	Engine Instruments	322-324, 326-328
Drink Holders	273	Engine Mounts	566-567
Drinking Water Filters	476, 481	Engine Oil	107, 528
Drinking Water Gear Pumps	480-481	Engine Room Ventilation	307-309, 609-611
Drinking Water Plastic Tube System Seatech	466-467	Engines, Inboard Diesel	506-524, 531-533
Drinking Water Pressure Systems	478-481	EPS Electronic Steering	046-050
Drinking Water Pumps	476-481, 492-493	Evaporators for cooling	428
Drinking Water Tank Senders	322-324, 326-327	Exhaust Dampers	601-603
Drinking Water Tanks Plastic	470	Exhaust Hose	464, 596
Drinking Water Taps	441-443	Exhaust Skin Fittings	600
Drinking Water Tubing System Seatech	466-467	Expanding Drain Plugs	170, 200-201
Drop Fenders	212	Expansion Tanks	479
D-Shackles Stainless Steel	208	Extraction Ventilators	307-308
DS-Units (Dual Station)	074	Extreme Steering „Xtreme“	031
Dyna Blocks	647	Extreme Steering „Xtreme“ (No Feedback)	031
		Eye Bolts Stainless Steel	210
		Eye Plates	210
<b>E</b>		<b>F</b>	
Echomax Radar Reflectors	248	Faeces Pumps	455-456, 485, 488-489, 492-493
Elastic Net and Object Holders	199	Faeces Tanks	455-457
Electric Fuel Line Valves	114, 596	Fairleads	203 275-276, 648, 660, 662
Electric Inflator Pump	168-169	Fairleads Plastic	203, 275, 660, 662
Electric Instruments	322-329	Fender Baskets	217
Electric Shift Kits for Technodrive Gearboxes	554	Fender Profiles	299-305
Electric Solenoid Valve for Fuel	114, 596	Fender Railing Brackets	217
Electric Solenoid Valve for Water (Toilet)	454	Fender Rope	238
Electric Toilets	448-451	Fender Snap Hooks	216
Electric Trailer Winches	187	Fenders	212-216
Electric Water Line Solenoid Valve	454, 467	Filler Kit & Flange Drinking Water Tanks	470-471
Electric Winches	626-627	Filler Kit & Flange Fuel Tanks	110, 597
Electrical Applications	325, 336-349	Filler Plugs SeaStar Helms	062
Electronic Engine Controls	082-089	Filter (water)	460, 476, 481, 484, 597, 605
Electronic Radar Reflector	248	Filters Cooling Water	605
Electronic Steering EPS	046-050	Filters Drinking Water	476, 481
Emergency Chain Connector	234	Fire Blanket	272
Emergency Ladder	312	Fire Extinguisher Built-In Box	272
Emergency Navigation Lights	381-382		
Emergency Plugs	258		

## TABLE OF CONTENTS

Fire Extinguishers	272	Gas/Water Separator	602
First Aid Boxes	272	Gasoline Tanks	108-110, 597
Fishing Rod Holders	205	Gauges Electric	322-324, 326-328
Fitting Material	458-463, 604	Gauges NMEA 2000 Universal	322-324
Fittings SeaStar Hydraulics	061, 063	Gauges SeaStar - Veethree	322-324, 326-328
Flag Poles and Pole Bases	192-193	Gear pumps for drinking water	481
Flags	194-195	Gearbox Adapters	551-553
Flexible Black Water Tanks	457	Gearbox Flange Adapters	555
Flexible Engine Mounts	566-567	Gearbox Mounting Flanges	551-553
Flexible Propeller Shaft Couplings	556-565	Gearboxes	535-547
Flexible Water Tanks	457, 470	Generator Sets	408-415
Flex-O-Fold Folding Propellers	586	Genua Sliders	652-654, 662
Float Switches	483-484	Genua Systems	652-654, 662
Floatation Jackets and Suits	250-259	Genua Tracks	651-662
Flood Lights	386-387	Glass Fibre Stern Tube Propeller Shaft System	570
Fly Screens	615, 619	Goïot Hatches	616-620
Fog Horns	245-247	Goosenecks Plastic	603
Folding Boat Chairs	148-150, 154	GPS-Speedo's	322-324
Folding Cleats	276-277	Grab Rail Fittings	282-284
Folding Grapnels	233	Grab Rails	279
Folding Mast Steps	312	Grated Water Intakes	458, 604
Folding Propellers	586-587	Grey Water Collection Tank	457, 488
Foot Switches	228, 230	Grey Water Manifold (bilge)	487
Fortress Anchors	232	Grey-Water Manifold	487, 488
Fuel Filters	112-114, 590-595	Grey-Water Tank	457, 488
Fuel Filters with Water Separator	113-114, 590-591, 595	Grill Electric	436
Fuel Gauges	322-324, 326-327	Grommets Plastic	203
Fuel Hoses	116, 456, 596	Ground Strap SeaStar Outboard Cylinders	062
Fuel Line Connectors	115	Guardian Anchors	232
Fuel Senders	112, 328-329, 468, 596		
Fuel Tanks	108-110, 597	<b>H</b>	
Fuel Tanks Plastic	108-109, 597	Half Couplings	565
Fuel Tanks Stainless Steel	116, 597	Halogen Cabin Lights	352
Funnel	120	Halyard Organizer Blocks	631-633, 645, 664
Fuse Holders	339	Halyard Slider	650
		Halyard Stoppers (Jammers)	631-634
<b>G</b>		Halyards	242-244
Gangway/Stair	318	Handles for Winches	628-629
Gangways	319	Hatch Opening Stays	280-281, 619
Gas Hob Units	432-435, 437	Hatches - Goïot	619-620
Gas Springs	280-281	Hatches Plastic	292-295
Gas Stabilizer	440	Heat Exchangers	614
Gas Stoves and Ovens	429-437	Heating (Airco) Systems	416-419



## TABLE OF CONTENTS

Heating Systems	416-419, 613	Inboard Steering Systems	049-050, 052-059
Heavy Duty Mooring Spring	240	Indicators, Wind Socks	204
Hella APELO underwater lights	374	Induction Cooker	436
Hella LED Light Bars	385	Inflatable Boat Accessories	168-169
Hella Marine Lights	372-374, 383-385	Inflatable Boat Launching Wheels	171
Helm Pumps	054	Inflatable Boat Pumps	168-169
High Load Blocks	646	Inflatable Boat Roller (beach)	
Hinges	285-289	Inflatable Boat Steering	030
Hinges, covered	288	Inflatable Boat Valve	172
Hooks, Nylon	203	Inflatable Boats	174-177
Horns	245-247	Inflatable Radar Reflector	248
Horseshoe Life Buoy	257	Inflator Pumps	168-169
Hose Clamps	599, 604	Inner Shaft Bearings	573-576
Hose Connectors universal	607	Inspection Hatches	292-295
Hose Pilars	458, 463, 604	Instrument Panel Solé	526
Hoses	453, 464-465, 607-608	Intermediate Shaft Bearing Bushings	576
Hot water Boilers	472-475	Inverters	400-401
Hot Water Hose	465	Isolated Terminals	339
Hour Counters	322-324, 326-327		
Hull Lights	363, 374-375	<b>J</b>	
Hydraulic Hoses	060	Jack Plates SeaStar	125-127
Hydraulic Oil SeaStar	062	Jammers	631-634
Hydraulic Steering Cylinders	036-059	Jet Boat Steering	032
Hydraulic Steering Systems	036-059	Jetty Fenders	216
Hydrofoils	106	Jetty Mooring Eye portable	237
Hydrophores	478-479	Johnson - Pump Jabsco Ref. List	504-504
Hyundai Seasall Marine Diesel Engines	531-533	Johnson Impellers	494, 498-501
		Johnson Pump Marine Toilets	446-451
		Johnson Pump OEM Ref. List	496-497
		Johnson Pumps	476-477, 482-483, 485-491, 494-498
		Joysticks X-Force Bow Thrusters	090-093
		<b>K</b>	
		Keel Rollers	186-187
		Key Bolts	211
		Knob Latch	291
		<b>L</b>	
		Ladders	215, 310-316
		Latches for cupboard	291
		Launching Wheels	171
		Leaded Anchor Rope	234, 239
		LED Cabin Lights	356-362, 364-367, 370-373
<b>I</b>			
Ice Cube Makers	424, 426		
Ignition Switches	345		
Impeller Bar	494		
Impeller Pedestal Pumps	494-495		
Impeller Pumps	486-487, 494-497		
Impeller Pumps Electric	486-487		
Impeller-Flange Mounted Cooling Water Pumps	496-497		
Impeller-OEM-Pumps	495-497		
Impellers	138-146, 494, 498-501		
Impellers (Inboard-Johnson)	494, 498-501		
Inboard Controls	075-080, 082-089		
Inboard Engine Installation Kits	527		
Inboard Propellers	579-584, 586-587		
Inboard Steering Cylinders	055		

## TABLE OF CONTENTS

LED Chart Reading Lights	364, 373	Matrix Gauges Mercury SmartCraft	322
LED Courtesy Lights	368-370, 372	Mechanical Seals for Propeller Shafts	574-575
LED Dimmer	362, 367, 373	Mechanical Steering Systems	022-034
LED Lights for Engine Compartment	371	Mini Switch Panels Single Function	347
LED Navigation Lights	376-380, 382-384	Mixer Taps	441-443
LED Replacement Bulbs	355	Mixer Water Tap with Built-in Shower Box	444
LED Search Light	386-387	Mobile Coolers	427
LED Underwater Lights	363, 374-375	Mooring Hook	188
LED Wall Lights	365-367	Mooring Pins	237
Life Jackets	250-259	Mooring Ropes	238-239, 241-242
Life Lines	259	Mooring Springs	240
Lifebuoy Holders	258	Motion Activated Lamps	371
Lifebuoy's	257	Motion Activated Switch	371
Lift Ring	202, 290-291	Motor Flusher	120
Lights	352-387	Motor Oil Filters Solé	528-529
Liquid Tie Bar	061	Motor Sound Deadening Plates	612
Lock for Outboard Motors	124	Mounting Flange for Stern Tube	577
Lofrans Windlasses	218-226	Mounting Tray's Plastic	119
Loud Hailer Marine Speakers	245	Multi Port Shower Sump	488
Loudspeakers for Radio	351	Multifenders for Mooring Poles	216
Louvres and Grills	309, 611		
Low Friction Rings & Loops	648-649	<b>N</b>	
Lower Unit Gear Lube	107	Nautical Bucket	191, 197, 486
		Navigation Lights	376-384
<b>M</b>		Navigation Materials	271
Macerator Pumps	455-456, 488	Nemo Stay Tensioners	621
Magnesium Anodes	128-137	Neoprene Shaft Bearings	578
Magnetic Door Catches	290-291	Net for Bow Rail	240
Main Sheet Tackles	638-639	NFB 4.2 Rotary Steering System (No Feedback)	027
Main Travellers	655-657, 661	NMEA Cabels and Connectors	343
Mainsail Centipede	206		
Manual Bilge Pumps	197, 485-486	<b>O</b>	
Manual Oil Extraction Pump	107, 612	Oars	188-189
Manual Search Lights	386-387	Odor Filters	455-456, 597
Manual Toilets	447	Oil and Grease	107
Marine Diesel Generating Sets	408-415	Oil Change Pumps electric	486
Marine Engines	506-524, 531-533	Oil Coolers	551-553
Marine Reversing Gears	535-547	Oil Extraction Pumps	107, 486, 612
Marine Toilets	446-451	Oil Filter Solé Diesel	528-529
Marker Buoy's	214, 237	Oil Pressure Gauges	322-324, 326-328
Marker Floats	214	Organizers	631-633, 645, 664
Marline Spike	240	Outboard Covers	120
Mast Steps	312	Outboard Engines	178-184

## TABLE OF CONTENTS

Outboard Motor Accessories	106, 108-109, 112-127	Pump Hose	202
Outboard Motor Brackets	123, 125, 127	Pumps	476-498
Outboard Motor Controls	075-080, 082-089	Purging System SeaStar Hydraulic Steering	040, 042, 061
Outboard Motor Flusher	120	Push Button Switches wit LED Indicator	340
Outboard Motor Fuel Tanks	108-109	Push/Pull Control Cables	072-073
Outboard Motor Lock	124	Push/Pull Switches	342
Outboard Motor Powerlifts	125-127		
Outer Bearing for Propeller Shafts	577	<b>R</b>	
Ovens	429-431	Rack & Pinion Steering System	028
		Rack & Pinion Steering System (No Feedback)	029
<b>P</b>		Racor Filtration	590-593
Paddles	189	Radar Reflector Tubular	204
Padlocks	124	Radar Reflectors	248-249
Pedestals for Boat Chairs	152, 157, 160-161	Radice Rudders and Propellers	065, 580-585, 587
Pinwing Kits for Impeller Pumps	495	Radio	351
Pitot	329	Radio Antenna	351
Plough Anchors	233	Radio Control Search Light	387
Pop-Out Cleats	277	Radio Cover	350
Portable LED Navigation Lights	382	Railing Fittings	284-284
Portlights	615, 618	Ratchet Blocks	660
Power Assist Systems	044-045	Reading Lamps	352, 364-367, 373
Power Plugs	405-407	Re-arming Kits for Automatic Life Jackets	256
Power Purge Junior	040, 042, 061	Reefing Hooks	203
Power Steering Systems	044-045	Refrigerators	420-428
Powerlifts for Outboards	125-127	Refrigerators Stainless Steel	422-426
Powertrim Switch	126	Remote Controls	075-080, 082-089
Pressure Gauge for Inflatable Boats	168	Replacement Bulbs	354-355
Pressure Switch	486	Rescue Light for Lifebuoy	258
Primer Bulb (with fuel line)	116	Rescue Materials	250-259, 272
Propeller Shaft Bearing Bushings	578	Revolving Bent Anchor Joint Stainless Steel	236
Propeller Shaft Bearings	573-577	Ritchie Compasses	262-270
Propeller Shaft Intermediate Bearings	576	Rope Cleats	634, 636, 640, 642, 644, 658-660, 662-663
Propeller Shaft Rope Cutters	589	Rope Cutters for Propeller Shaft	589
Propeller Shaft Struts	577	Rope Cutters for Saildrive	589
Propeller Shaft Systems	570-572	Rope Ladder	312, 315
Propeller Shafts	568	Ropes	241-244
Propellers	579-587	Rowlock Sockets	202
Propellers, Bronze and Aluminum	579-587	Rowlocks	172, 202
Protection Pads	119	Rubber Couplings	565
Protrim Switches	126	Rubber Impellers	138-146, 494, 498-501
PSS Mechanical Seals	574	Rubber Propeller Shaft Bearings	578
P-Trap Tank Vent Adapter	112	Rubber Propeller Shaft Seals	573
Pump (Syphon) Hose	202	Rudder and Stern Fitting for Dinghies	665

## TABLE OF CONTENTS

Rudder Arms	064	Shift Control Cables	072-073
Rudder Glands, brass	064	Shock Cord	244
Rudder kits for Dinghies	665	Shore Power Connectors	405-407
Rudder Position Indicators	328	Shower Built-in Box with Mixer Tap	444
Rudders Bronze	065	Showers	444-445
Rug	199	Shut-Off Control Cables	074
<b>S</b>		Sierra	107, 114-115, 337, 341, 345
Safe-T II (No Feedback) Steering System	026	Sierra Battery Switches	337
Safe-T Quick Connect Steering System	025	Sierra HALO Switches	341
Safe-T Quick Connect Steering System - Tilt	024	Sierra Oil	107
Safe-T Quick Connect Tilt Steering	024	Signal Flags	194
Safety (Kill) Switches	117	Signal Horns	245-247
Safety Bag	251	Single Handle - Dual Action - Motor Controls	075-080, 082-089
Safety Harness	259	Sinks	435, 438-439
Sail Ties	206	Ski Mirror	188
Saildrive (Volvo) Adapter Kits Solé	524	Skin Fitting Plastic	461-463
Saildrive propellers	585-587	Skin Fitting Plastic with Check Valve	201
Saildrive Rope Cutters	589	Skin Fitting Stainless Steel	600
Saildrive Unit Technodrive	547	Skin Fittings	458, 461-463
Schelde Anchors	232	Slam Latches	289-290
Sea Prop 60 Technodrive Saildrive Unit	547	Sleeves for Drain Plugs	200-201
Search Lights	386-387	Smart Tabs	104-105
SeaStar EPS	046-050	Smartsticks	044-061
SeaStar Outboard Steering Systems	023-051	Snap Davits for inflatable Boat	170
SeaStar Steering & Controls	022-081	Snap Hooks	203
SeaStar Trim Tabs	094-99	Snap Hooks Stainless Steel	209
Security Line	259	Snap Shackles	209
Security Materials	245-259, 272	Solar Power Ventilator	308-610
Security Rope	258-259	Solé Diesel Marine Engines	506-524
Seftailing Winches	623-627	Solé Engine Re-Powering Brackets	525
Selector Units	074	Solé Service Items	528-529
Self-Centering Keel Roller	186	Solenoid Control Boxes	231
Selva 4-Stroke Outboard Engines	178-184	Sound Deadening Material	612
Selva Service Parts	185	Sound Isolation Material	612
Selva Twin Outboard Sets	184	SPA SeaStar Power Assist	044-045
Service Parts Solé Diesel	528-529	Space Saver Marine Toilet	448-449
Servo Steering SeaStar Power Assist	044-045	Spare Parts Solé Diesel	528-529
Shackles Stainless Steel	208	Speakers	351
Shaft Systems (propeller)	570-572	Speedo's	322-324, 326-328
Shafts (propeller)	568	Speedy Lock Winch Handle	629
Sheaves Nylon	207	Sponges	190
Sheets	242-244	Spray Hood Fittings	282-284
		Springfield Boat Chairs	148-161

## TABLE OF CONTENTS

Stabilizer Tabs	106	Telescopic Boat Hooks	189
Stainless Steel Blocks	636-637, 644, 646, 664	Tensioning Strips Stainless Steel	211
Stainless Steel Built-in Fuel Tanks	116, 597	Thimbles Nylon & Stainless Steel	207
Stanchions and Stanchion Bases	211	Thrust Bearings	559, 562
Stand for Outboard Motor	122	Thrusters	090-093
Starting Rope	116	Tiller Extension for Dinghie Rudders	665
Static Folding Dock Stairs	320	Tiller Extensions	120
Stay Tensioners	621	Tin Holders	273
Steering Boat Chairs	148-161	Toggle Switches	340-341
Steering cable grommets	118	Toggle Switches wit LED Indicator	340-341
Steering Cables	023-032	Toilet Hoses	453, 465
Steering Console	030, 175	Toilet Installation Parts	453-457
Steering Cylinders for Inboards	049-050, 052-059	Toilet Space Saver	448-449
Steering Cylinders for Outboards	036-051	Toilet Spare Parts	452-453
Steering Cylinders for Stern Drives	049-050, 058-059	Toilets	446-451
Steering Handles	068-069	Toilets for Below Waterline Mounting	446-451
Steering Helm Hydraulic	054	Tournament Steering Cylinder	042-043
Steering Systems hydraulic	036-059	Trailer Rollers	186-187
Steering Wheels	066-069	Trailer Winch Webbing	187
Stern Bearings for Propeller Shafts	577	Trailer Winches	187
Stern Navigation Lights	376, 378, 380, 384	Transom Protection Pads	119
Stern Tubes	572	Trapeze Gear	663
Stern Tubes Brass	572	Traveller Control Unit	630
Sterndrive Steering Systems	049-050, 058-059	Travellers	652-657, 661-662
Sting Ray Hydrofoils	106	Tri-Color Navigation Lamp	381, 383
Strakes	299-305	Trim Boxes	665
Support Struts for Propeller Shafts	577	Trim Gauges	322-324, 326-327
Switch Panels	325, 346-349	Trim Switches	126
Switches	340-345	Trim Systems	100-105
Swivel Haps	285	Trim Tabs	100-105
Swivels	237	Trolling Valves	554
		Tubing for Guard Railing and Grab Rails	284
		Turnbuckles	211, 621
		Twin Halyard Block	646
		Twin Seat for Inflatable Boats	175
		Twisted Shackles Stainless Steel	208
		<b>U</b>	
		U-Bolts (Shroud Plates)	207
		Underwater Lights LED	363, 374-375
		Universal Hose Connectors	607
		Universal Kill Switch Key Sets	117
		Universal Shackle Key	207
<b>T</b>			
Table Pedestals	158-159		
Tables	159		
Tachometers	322-324, 326-327		
Tank Accessories	110-116, 119		
Tank Fixing Braces Stanless Steel	116, 597		
Tank Senders	112, 328-329, 468, 596		
Tank Senders Drinking- & Black Water	112, 329, 468		
Teak Table Tops	159		
Technodrive Marine Reversing Gears	535-547		
Teleopic Boat Chair Pedestals	152, 157, 160-161		

## TABLE OF CONTENTS

USB Charger Plug	344-345, 347	Waterlocks Plastic	603
<b>V</b>		Waterlocks Stainless Steel	601
Vacuum Switch	487	Watertanks Senders	322-324, 326-327
Vacuum Toilets	450-451	Watertanks Stainless Steel & Plastic	116, 471, 597
Valves	459, 463, 470, 604	Watertight Containers	196-197
VeeConnect Digital Switching System NMEA	325	Wave Damping Boat Chair System	155
Veethree Universal Engine Monitor System	324	Wet Notes Ritchie	262
Ventilation	307-309, 609-611	Winch Handles	628-629
Ventilation Hose	308, 610	Winches	622-627
Ventilation Louvres and Grill, Butterfly Vents	308-309, 610-611	Winches Electric	626-627
Ventilation Systems	307-309, 609-611	Winches for Sheets	622-627
Volt Gauges	322-324, 326-327	Wind Indicators	204
Volt Reducer	329	Windlass Accessories	227-228, 230-231
Volvo Saildrive Adapter kits for Solé	524	Windlasses	218-226
Volvo Sterndrive SAE-7 Adapter	550	Windshield Wipers	330-335
<b>W</b>		Wipers	330-335
Wall Lamps	352, 365-367	Wireless Remote Control	092, 227-228, 230
Wash Brushes	190	Wire-Rope Grips	207
Washing Bowls	435, 438-439	Wobble Rollers	186
Waste Water Discharge Deck Plate	455	<b>X</b>	
Waste Water Tank Senders	112, 329, 468	Xenon Search Light	387
Waste Water Tanks (sets)	456-457	X-Force Bow Thrusters	090-093
Water Hose	464-465, 607-608	<b>Y</b>	
Water Pressure Systems	478-481	Y-Connectors	463
Water Scoop Kits	575	<b>Z</b>	
Water Ski Accessories	188	Zinc Anodes	128-137
Water Ski Mirror	188		
Water Ski Rope	188		
Water Sports Helmet	256		
Water Taps	441-443		
Water Temperature Gauges	322-324, 326-327		
Water Tubing System SeaTech	466-467		
Water/Gas Separator	602		
Waterlocks	601-603		











**allpa** is a leading European wholesaler with 5.000m<sup>2</sup> Warehouse.

Founded in 1971, the company is engaged in sales and marketing of parts and accessories. Soon, the understanding came that there is more to an „European Player“ than sales only: Service and competent advice are the base of the expertise in Nijmegen. Highly qualified and motivated employees are together a decisive team which is dedicated to „customer relationship“.

**allpa** is a strong and dynamic international wholesaler with products for all kinds of water sports, for sailing- and motor yacht shipyards, nautical shops, service companies, inboard- and outboard motor dealers and also for commercial shipyards. The international approach is also illustrated by our comprehensive, annual catalog of about 600 pages, available in three languages.

**Points of Competence:**

- A very extensive product range
- Products with good price-quality ratio
- A very large stock
- Good logistics: short delivery lead times
- Professional advice
- Very regularly, innovative, state of the art products, are added to our range

**allpa supplies among other things:**

- Marine diesel engines and generators, complete installation kits
- Marine reversing gears, controls and steering systems, propellers, propeller shaft systems
- Outboard engines and accessories, inflatable and polyester boats, boat chairs and trim tabs
- Windlasses, bow thrusters and gangways
- Sanitary systems, bilge-, drinking water-, cooling water-, black water- and fuel pumps
- Refrigerators, boilers, battery chargers and inverters
- Rescue materials, compasses and radar reflectors
- Winches and deck fittings, hatches and ports, stay tensioners



Kerkenbos 1015, 6546 BB Nijmegen  
T: +31 (0)24 - 377 77 73  
E: [info@allpa.eu](mailto:info@allpa.eu)  
[www.allpa-marine.com](http://www.allpa-marine.com)



**We have  
it all(pa)**



Delivery via trade only. Dealer search on:

**[www.allpa-marine.com](http://www.allpa-marine.com)**

Kerkenbos 1015 • 6546 BB Nijmegen • Netherlands  
T +31 (0)24 - 377 77 73 | E [info@allpa.eu](mailto:info@allpa.eu)  
[www.allpa.nl](http://www.allpa.nl) • [www.allpa-marine.com](http://www.allpa-marine.com)